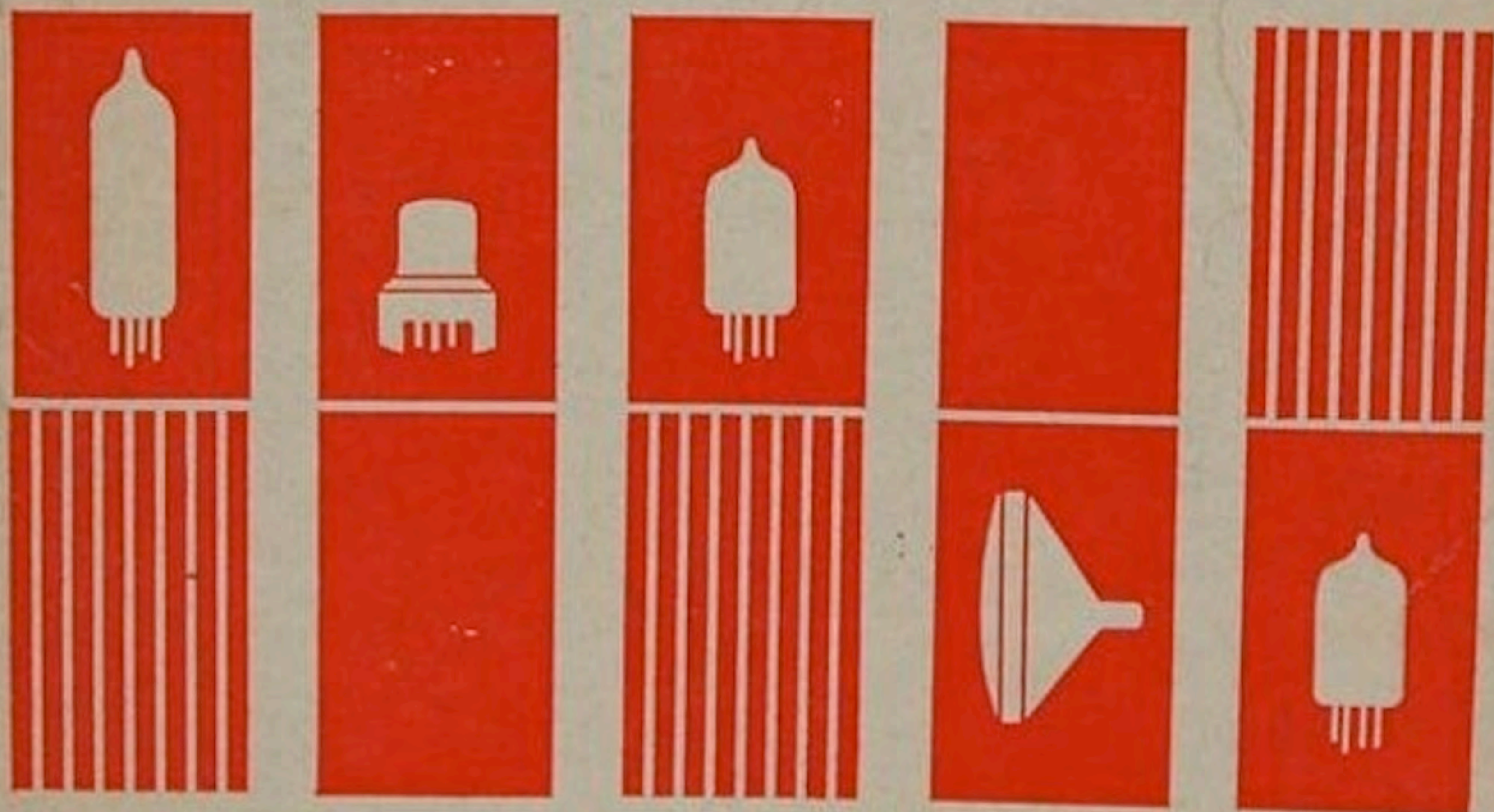


# RCA

TECHNICAL SERIES RC-25 \$1.25

Suggested  
Price

# RECEIVING TUBE MANUAL



**RADIO CORPORATION OF AMERICA**

ELECTRONIC COMPONENTS AND DEVICES • HARRISON, NEW JERSEY



# RCA

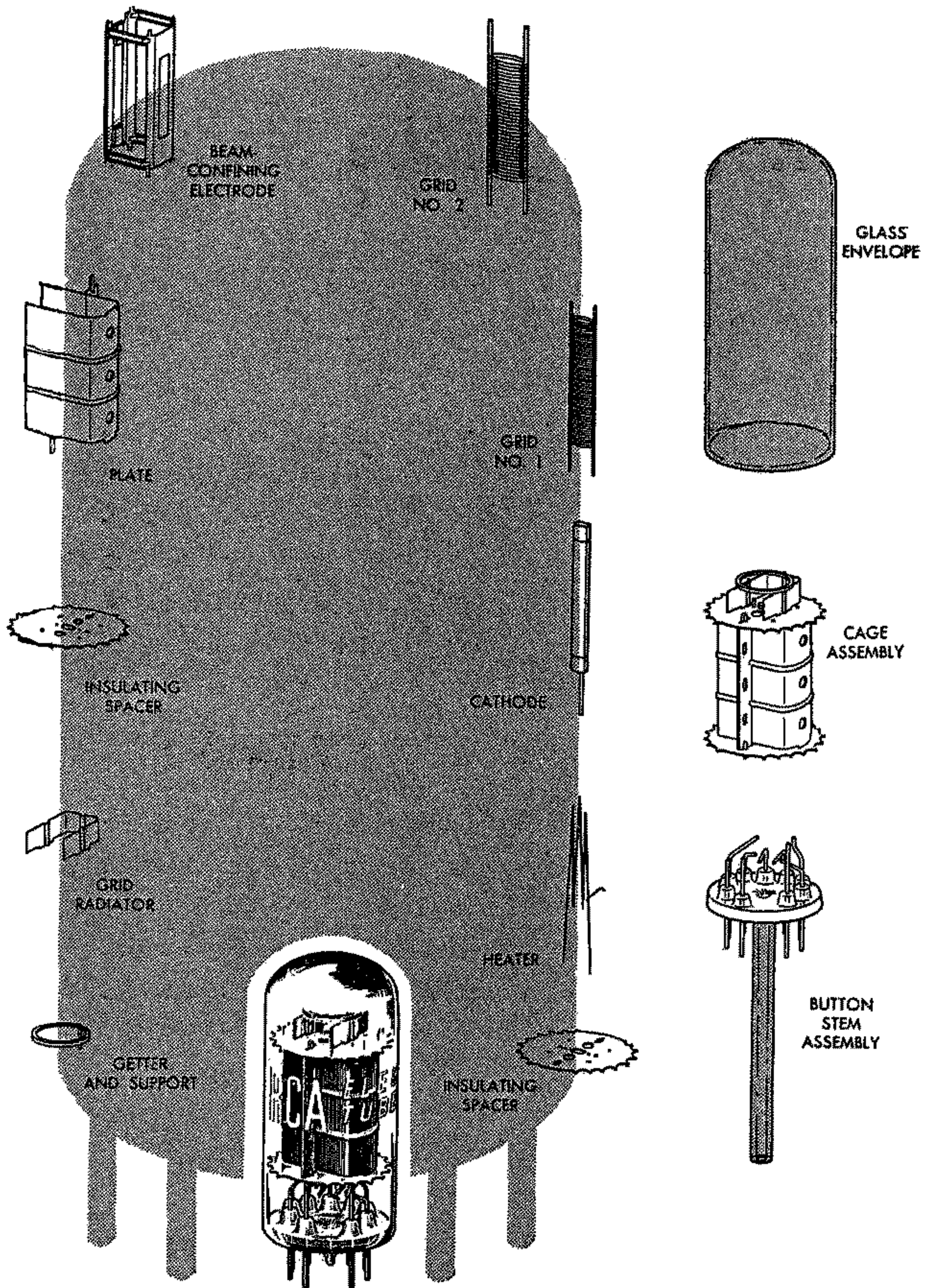
## Receiving Tube Manual

**THIS MANUAL**, like its preceding editions, has been prepared to assist those who work or experiment with home-entertainment-type electron tubes and circuits. It will be found valuable by engineers, service technicians, educators, experimenters, radio amateurs, hobbyists, students, and many others technically interested in electron tubes.

The material in this edition has been augmented and revised to include the recent technological advances in the electronics field. For more convenient referencing of the latest tube types, the Technical Data Section has been restricted to coverage of active RCA types; basic data for replacement and discontinued RCA tubes are given in the **RCA Types for Replacement Use** table.

**RADIO CORPORATION OF AMERICA**  
ELECTRONIC COMPONENTS AND DEVICES                      HARRISON, N. J.





**PARTS OF A NOVAR TUBE**



# Electrons, Electrodes and Electron Tubes

**T**HE electron tube is a marvelous device. It makes possible the performing of operations, amazing in conception, with a precision and a certainty that are astounding. It is an exceedingly sensitive and accurate instrument—the product of coordinated efforts of engineers and craftsmen. Its construction requires materials from every corner of the earth. Its use is world-wide. Its future possibilities, even in the light of present-day accomplishments, are but dimly foreseen, for each development opens new fields of design and application.

The importance of the electron tube lies in its ability to control almost instantly the flight of the millions of electrons supplied by the cathode. It accomplishes this control with a minimum of energy. Because it is almost instantaneous in its action, the electron tube can operate efficiently and accurately at electrical frequencies much higher than those attainable with rotating machines.

## Electrons

All matter exists in the solid, liquid, or gaseous state. These three forms consist entirely of minute divisions known as molecules, which, in turn, are composed of atoms. Atoms have a nucleus which is a positive charge of electricity, around which revolve tiny charges of negative electricity known as electrons. Scientists have estimated that electrons weigh only 1/30-billion, billion, billion, billionths of an ounce, and that they may travel at speeds of thousands of miles per second.

Electron movement may be accelerated by the addition of energy. Heat is

one form of energy which can be conveniently used to speed up the electron. For example, if the temperature of a metal is gradually raised, the electrons in the metal gain velocity. When the metal becomes hot enough, some electrons may acquire sufficient speed to break away from the surface of the metal. This action, which is accelerated when the metal is heated in a vacuum, is utilized in most electron tubes to produce the necessary electron supply.

An electron tube consists of a cathode, which supplies electrons, and one or more additional electrodes, which control and collect these electrons, mounted in an evacuated envelope. The envelope may be made of glass, metal, ceramic, or a combination of these materials.

## Cathodes

A cathode is an essential part of an electron tube because it supplies the electrons necessary for tube operation. When energy in some form is applied to the cathode, electrons are released. Heat is the form of energy generally used. The method of heating the cathode may be used to distinguish between the different forms of cathodes. For example, a directly heated cathode, or filament-cathode, is a wire heated by the passage of an electric current. An indirectly heated cathode, or heater-cathode, consists of a filament, or heater, enclosed in a metal sleeve. The sleeve carries the electron-emitting material on its outside surface and is heated by radiation and conduction from the heater.

A filament, or directly heated cathode, such as that shown in Fig. 1 may



be further classified by identifying the filament or electron-emitting material. The materials in regular use are tungsten, thoriated tungsten, and metals which have been coated with alkaline-earth oxides. Tungsten filaments are made from the pure metal. Because they must operate at high temperatures (a dazzling white) to emit sufficient electrons, a relatively large amount of filament power is required.

Thoriated-tungsten filaments are made from tungsten impregnated with thorium oxide. Due to the presence of thorium, these filaments liberate electrons at a more moderate temperature of about 1700°C (a bright yellow) and are, therefore, much more economical of filament power than are pure tungsten filaments.

Alkaline earths are usually applied as a coating on a nickel-alloy wire or ribbon. This coating, which is dried in a relatively thick layer on the filament, requires only a relatively low temperature of about 700-750°C (a dull red) to produce a copious supply of electrons. Coated filaments operate very efficiently and require relatively little filament power. However, each of these cathode materials has special advantages which determine the choice for a particular application.

Directly heated filament-cathodes require comparatively little heating power. They are used in tube types designed for battery operation because it is, of course, desirable to impose as small a drain as possible on the batteries. They are also used in rectifiers such as the 1G3GT/1B3GT and the 5Y3GT.

An indirectly heated cathode, or heater-cathode, consists of a thin metal sleeve coated with electron-emitting material such as alkaline-earth oxides. The emissive surface of the cathode is maintained at the required temperature (approximately 1050°K) by resistance-heating of a tungsten or tungsten-alloy wire which is placed inside the cathode sleeve and electrically insulated from it, as shown in Fig. 2. The heater is used only for the purpose of heating the cathode sleeve and sleeve coating to an electron-emitting temperature.

Useful emission does not take place from the heater wire.

A new dark heater insulating coating developed by RCA has better heat transfer than earlier aluminum-oxide coatings, and makes it possible to operate heaters at lower temperatures for given power inputs. Because the tensile strength of the heater wire increases at the lower operating temperatures, tubes using dark heaters have increased reliability, stability, and life.

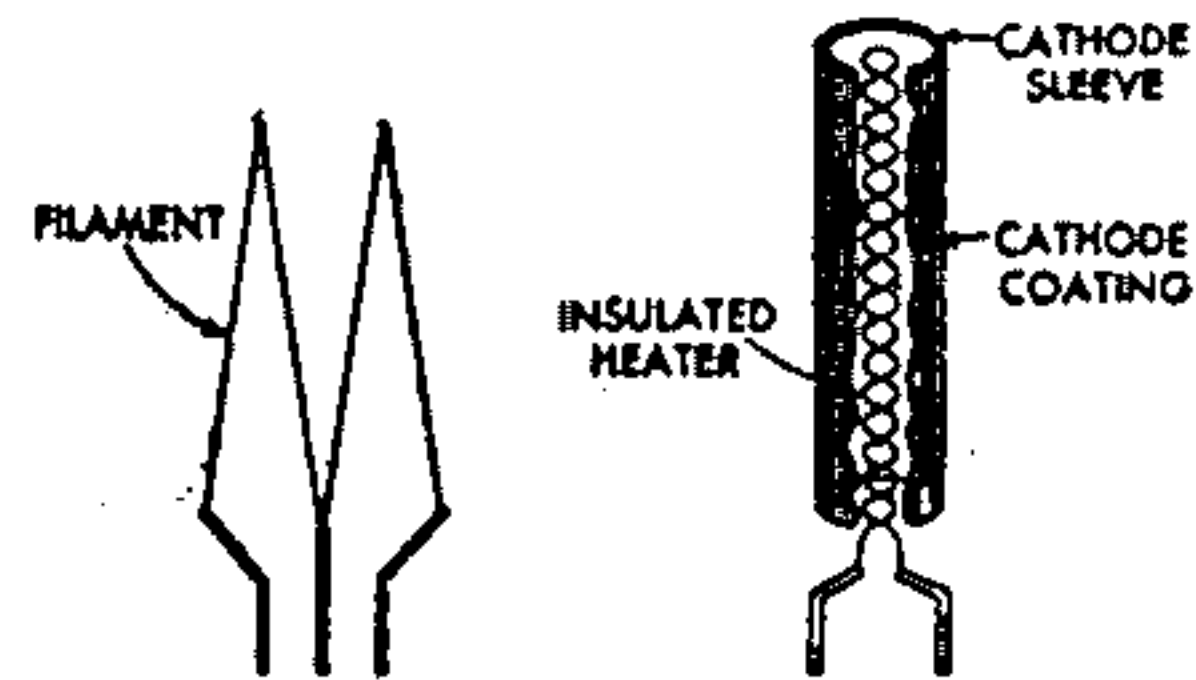


Fig. 1—Filament  
or directly heated  
cathode.

Fig. 2—Indirectly  
heated cathode or  
heater-cathode.

The heater-cathode construction is well adapted for use in electron tubes intended for operation from ac power lines and from storage batteries. The use of separate parts for emitter and heater functions, the electrical insulation of the heater from the emitter, and the shielding effect of the sleeve may all be utilized in the design of the tube to minimize the introduction of hum from the ac heater supply and to minimize electrical interference which might enter the tube circuit through the heater-supply line. From the viewpoint of circuit design, the heater-cathode construction offers advantages in connection flexibility because of the electrical separation of the heater from the cathode.

Another advantage of the heater-cathode construction is that it makes practical the design of a rectifier tube having close spacing between its cathode and plate, and of an amplifier tube having close spacing between its cathode and grid. In a close-spaced rectifier tube, the voltage drop in the tube is low, and, therefore, the regulation is improved. In an amplifier tube, the close spacing increases the gain obtainable from the tube. Because of the



advantages of the heater-cathode construction, almost all present-day receiving tubes designed for ac operation have heater-cathodes.

### Generic Tube Types

Electrons are of no value in an electron tube unless they can be put to work. Therefore, a tube is designed with the parts necessary to utilize electrons as well as those required to produce them. These parts consist of a cathode and one or more supplementary electrodes. The electrodes are enclosed in an evacuated envelope having the necessary connections brought out through air-tight seals. The air is removed from the envelope to allow free movement of the electrons and to prevent injury to the emitting surface of the cathode.

When the cathode is heated, electrons leave the cathode surface and form an invisible cloud in the space around it. Any positive electric potential within the evacuated envelope offers a strong attraction to the electrons (unlike electric charges attract; like charges repel). Such a positive electric potential can be supplied by an anode (positive electrode) located within the tube in proximity to the cathode.

### Diodes

The simplest form of electron tube contains two electrodes, a cathode and an anode (plate), and is often called a diode, the family name for a two-electrode tube. In a diode, the positive potential is supplied by a suitable electrical source connected between the plate terminal and a cathode terminal, as shown in Fig. 3. Under the influence of the positive plate potential, electrons

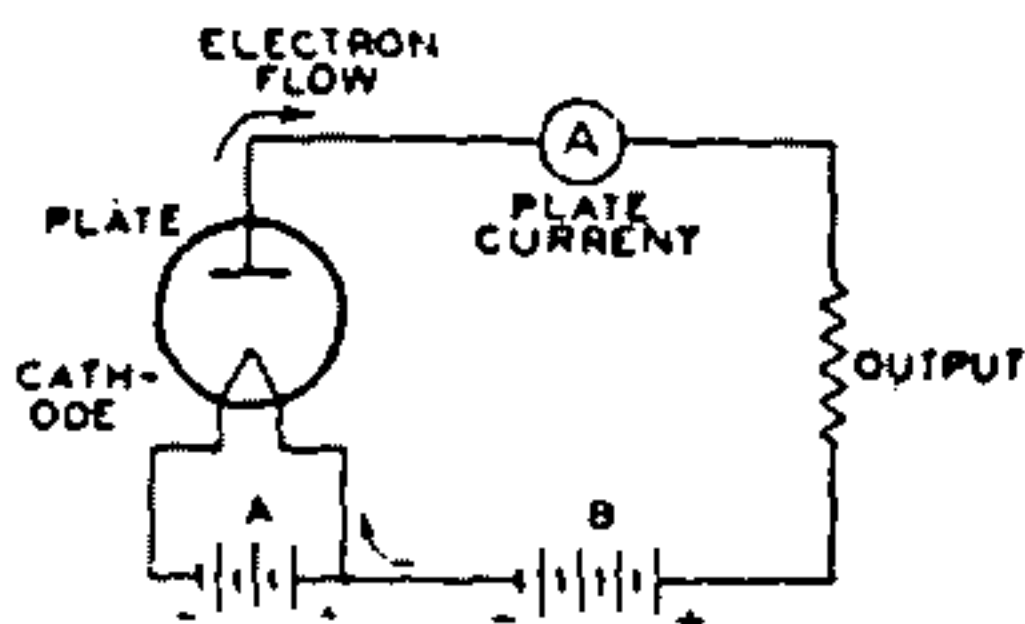


Fig. 3—Basic diode circuit.

flow from the cathode to the plate and return through the external plate-battery circuit to the cathode, thus completing the circuit. This flow of electrons is known as the **plate current**.

If a negative potential is applied to the plate, the free electrons in the space surrounding the cathode will be forced back to the cathode and no plate current will flow. If an alternating voltage is applied to the plate, the plate is alternately made positive and negative. Because plate current flows only during the time when the plate is positive, current flows through the tube in only one direction and is said to be **rectified**. Fig. 4 shows the rectified output current produced by an alternating input voltage.

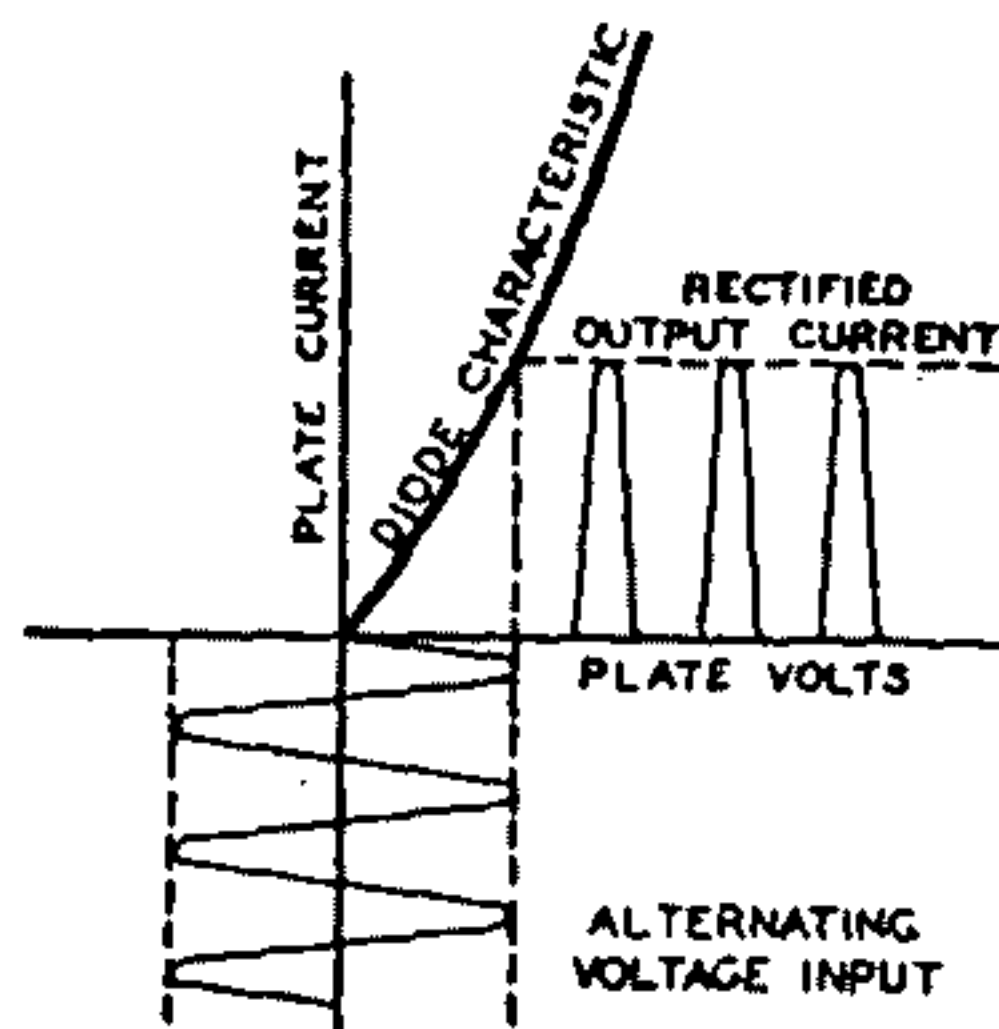


Fig. 4—Current characteristics of rectifier circuit.

Diode rectifiers are used in ac receivers to convert the ac supply voltage to dc voltage for the electrodes of the other tubes in the receiver. Rectifier tubes having only one plate and one cathode, such as the 35W4, are called **half-wave rectifiers**, because current can flow only during one-half of the alternating-current cycle. When two plates and one or more cathodes are used in the same tube, current may be obtained on both halves of the ac cycle. The 6X4, 5Y3GT, and 5U4GB are examples of this type and are called **full-wave rectifiers**.

Not all of the electrons emitted by the cathode reach the plate. Some return to the cathode, while others remain in the space between the cathode and plate for a brief period to produce



an effect known as **space charge**. This charge has a repelling action on other electrons which leave the cathode surface and impedes their passage to the plate. The extent of this action and the amount of space charge depend on the cathode temperature, the distance between the cathode and the plate, and the plate potential. The higher the plate potential, the less is the tendency for electrons to remain in the space-charge region and repel other electrons. This effect may be noted by applying increasingly higher plate voltages to a tube operating at a fixed heater or filament voltage. Under these conditions, the maximum number of available electrons is fixed, but increasingly higher plate voltages will succeed in attracting a greater proportion of the free electrons.

Beyond a certain plate voltage, however, additional plate voltage has little effect in increasing the plate current because all of the electrons emitted by the cathode are already being drawn to the plate. This maximum current, illustrated in Fig. 5, is called **saturation current**. Because it is an indication of the total number of electrons emitted, it is also known as **emission current** or simply **emission**.

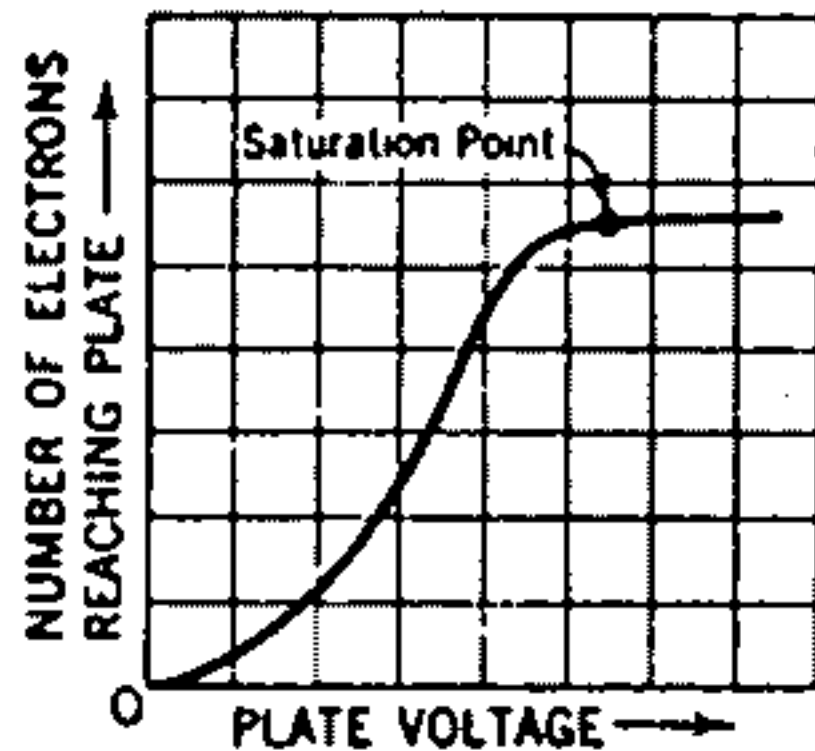


Fig. 5—Current characteristic of diode tube.

Although tubes are sometimes tested by measurement of their emission current, it is generally not advisable to measure the full value of emission because this value would be sufficiently large to cause change in the tube characteristics or even to damage the tube. Consequently, while the test value of emission current is somewhat larger than the maximum current which will be required from the cathode in the

use of the tube, it is ordinarily less than the full emission current. The emission test, therefore, is used to indicate whether the cathode can supply a sufficient number of electrons for satisfactory operation of the tube.

If space charge were not present to repel electrons coming from the cathode, the same plate current could be produced at a lower plate voltage. One way to make the effect of space charge small is to make the distance between plate and cathode small. This method is used in rectifier types having heater-cathodes, such as the 5V4GA and the 6AX5GT. In these types the radial distance between cathode and plate is only about two hundredths of an inch.

Another method of reducing space-charge effect is utilized in **mercury-vapor rectifier tubes**. When such tubes are operated, a small amount of mercury contained in the tube is partially vaporized, filling the space inside the bulb with mercury atoms. These atoms are bombarded by electrons on their way to the plate. If the electrons are moving at a sufficiently high speed, the collisions tear off electrons from the mercury atoms. The mercury atom is then said to be "**ionized**," i.e., it has lost one or more electrons and, therefore, has a positive charge. Ionization is evidenced by a bluish-green glow between the cathode and plate. When ionization occurs, the space charge is neutralized by the positive mercury atoms so that increased numbers of electrons are made available. Mercury-vapor tubes are used primarily for power rectifiers.

**Ionic-heated-cathode rectifiers** depend on gas ionization for their operation. These tubes are of the full-wave design and contain two anodes and a coated cathode sealed in a bulb containing a reduced pressure of inert gas. The cathode becomes hot during tube operation, but the heating effect is caused by bombardment of the cathode by ions within the tube rather than by heater or filament current from an external source.

The internal structure of an ionic-heated-cathode tube is designed so that when sufficient voltage is applied to the tube, ionization of the gas occurs be-



tween the anode which is instantaneously positive and the cathode. Under normal operating voltages, ionization does not take place between the anode that is negative and the cathode, so that the requirements for rectification are satisfied. The initial small flow of current through the tube is sufficient to raise the cathode temperature quickly to incandescence, whereupon the cathode emits electrons. The voltage drop in such tubes is slightly higher than that of the usual hot-cathode gas rectifiers because energy is taken from the ionization discharge to keep the cathode at operating temperature. Proper operation of these rectifiers requires a minimum flow of load current at all times to maintain the cathode at the temperature required to supply sufficient emission.

### Triodes

When a third electrode, called the **grid**, is placed between the cathode and plate, the tube is known as a triode, the family name for a three-electrode tube. The grid usually consists of relatively fine wire wound on two support rods (siderods) and extending the length of the cathode. The spacing between turns of wire is large compared with the size of the wire so that the passage of electrons from cathode to plate is practically unobstructed by the grid. In some types, a **frame grid** is used. The frame consists of two siderods supported by four metal straps. Extremely fine lateral wire (diameter of 0.5 mil or less) is wound under tension around the frame. This type of grid permits the use of closer spacings between grid wires and between tube electrodes, and thus improves tube performance.

The purpose of the grid is to control the flow of plate current. When a tube is used as an amplifier, a negative dc voltage is usually applied to the grid. Under this condition the grid does not draw appreciable current.

The number of electrons attracted to the plate depends on the combined effect of the grid and plate polarities, as shown in Fig. 6. When the plate is positive, as is normal, and the dc grid volt-

age is made more and more negative, the plate is less able to attract electrons to it and plate current decreases. When the grid is made less and less negative (more and more positive), the plate more readily attracts electrons to it and plate current increases. Hence, when the voltage on the grid is varied in accordance with a signal, the plate current varies with the signal. Because a small voltage applied to the grid can control a comparatively large amount of plate current, the signal is amplified by the tube. Typical three-electrode tube types are the 6C4 and 6AF4A.

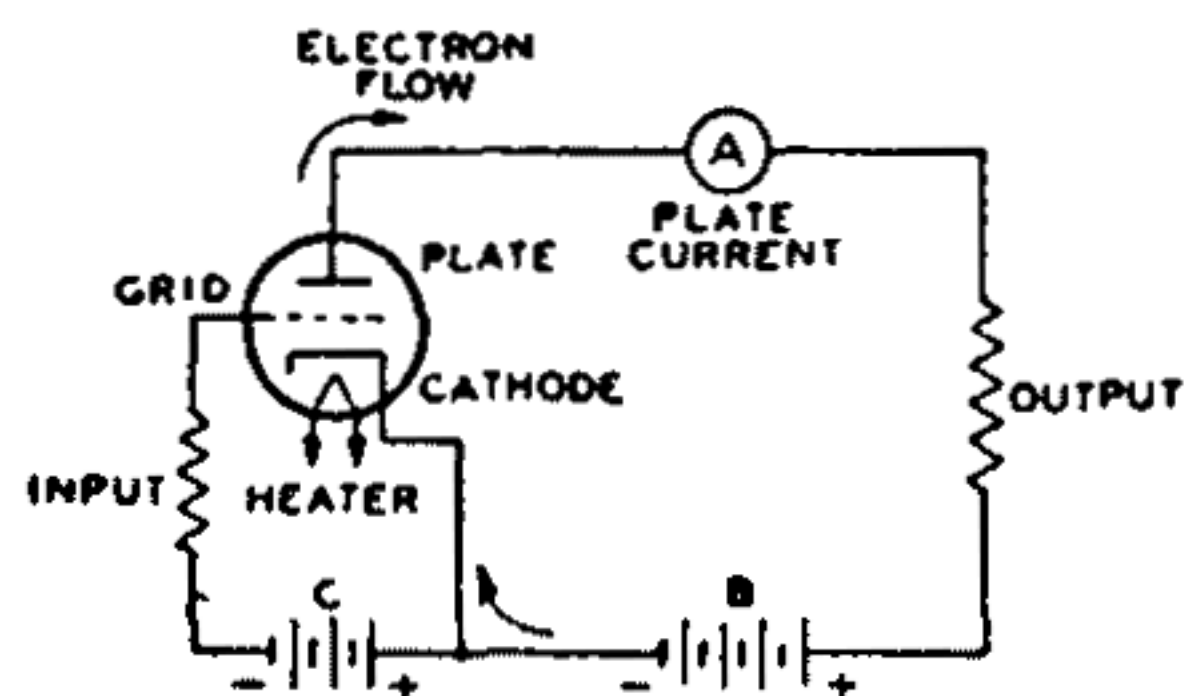


Fig. 6—Basic triode circuit.

The grid, plate, and cathode of a triode form an electrostatic system, each electrode acting as one plate of a small capacitor. The capacitances are those existing between grid and plate, plate and cathode, and grid and cathode. These capacitances are known as **inter-electrode capacitances**. Generally, the capacitance between grid and plate is of the most importance. In high-gain radio-frequency amplifier circuits, this capacitance may act to produce undesired coupling between the **input circuit**, the circuit between grid and cathode, and the **output circuit**, the circuit between plate and cathode. This coupling is undesirable in an amplifier because it may cause instability and unsatisfactory performance.

### Tetrodes

The capacitance between grid and plate can be made small by mounting an additional electrode, called the **screen grid** (grid No. 2), in the tube. With the addition of the grid No. 2, the tube has four electrodes and is, accordingly, called a tetrode. The screen



grid or grid No. 2 is mounted between the grid No. 1 (control grid) and the plate, as shown in Fig. 7, and acts as an electrostatic shield between them, thus reducing the grid-to-plate capacitance. The effectiveness of this shielding action is increased by a bypass

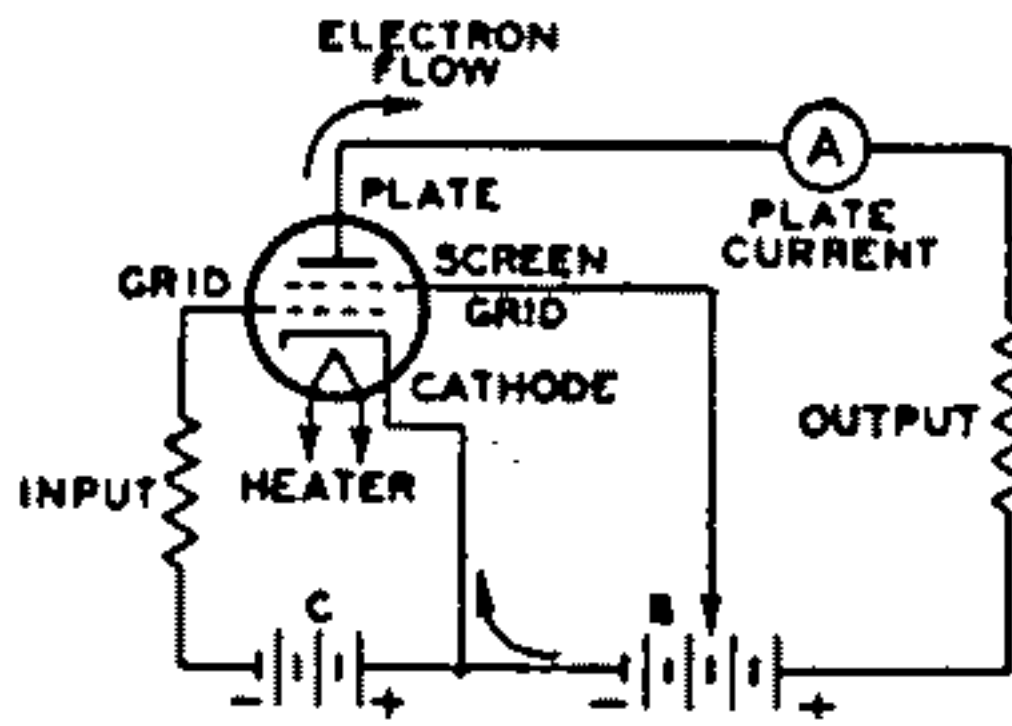


Fig. 7—Basic tetrode circuit.

capacitor connected between screen grid and cathode. By means of the screen grid and this bypass capacitor, the grid-plate capacitance of a tetrode is made very small. In practice, the grid-plate capacitance is reduced from several picofarads (pF) for a triode to 0.01 pF or less for a screen-grid tube.

The screen grid has another desirable effect in that it makes plate current practically independent of plate voltage over a certain range. The screen grid is operated at a positive voltage and, therefore, attracts electrons from the cathode. However, because of the comparatively large space between wires of the screen grid, most of the electrons drawn to the screen grid pass through it to the plate. Hence the screen grid supplies an electrostatic force pulling electrons from the cathode to the plate. At the same time the screen grid shields the electrons between cathode and screen grid from the plate so that the plate exerts very little electrostatic force on electrons near the cathode.

So long as the plate voltage is higher than the screen-grid voltage, plate current in a screen-grid tube depends to a great degree on the screen-grid voltage and very little on the plate voltage. The fact that plate current in a screen-grid tube is largely independent of plate voltage makes it possible to obtain much higher amplification with a tetrode than with a triode. The

low grid-plate capacitance makes it possible to obtain this high amplification without plate-to-grid feedback and resultant instability. In receiving-tube applications, the tetrode has been replaced to a considerable degree by the pentode.

### Pentodes

In all electron tubes, electrons striking the plate may, if moving at sufficient speed, dislodge other electrons. In two- and three-electrode types, these dislodged electrons usually do not cause trouble because no positive electrode other than the plate itself is present to attract them. These electrons, therefore, are drawn back to the plate. Emission caused by bombardment of an electrode by electrons from the cathode is called **secondary emission** because the effect is secondary to the original cathode emission.

In the case of screen-grid tubes, the proximity of the positive screen grid to the plate offers a strong attraction to these secondary electrons, and particularly so if the plate voltage swings lower than the screen-grid voltage. This effect reduces the plate current and limits the useful plate-voltage swing for tetrodes.

The effects of secondary emission are minimized when a fifth electrode is placed within the tube between the screen grid and plate. This fifth electrode is known as the **suppressor grid** (grid No. 3) and is usually connected to the cathode, as shown in Fig. 8. Because of its negative potential with respect to the plate, the suppressor grid retards the flight of secondary electrons and diverts them back to the plate.

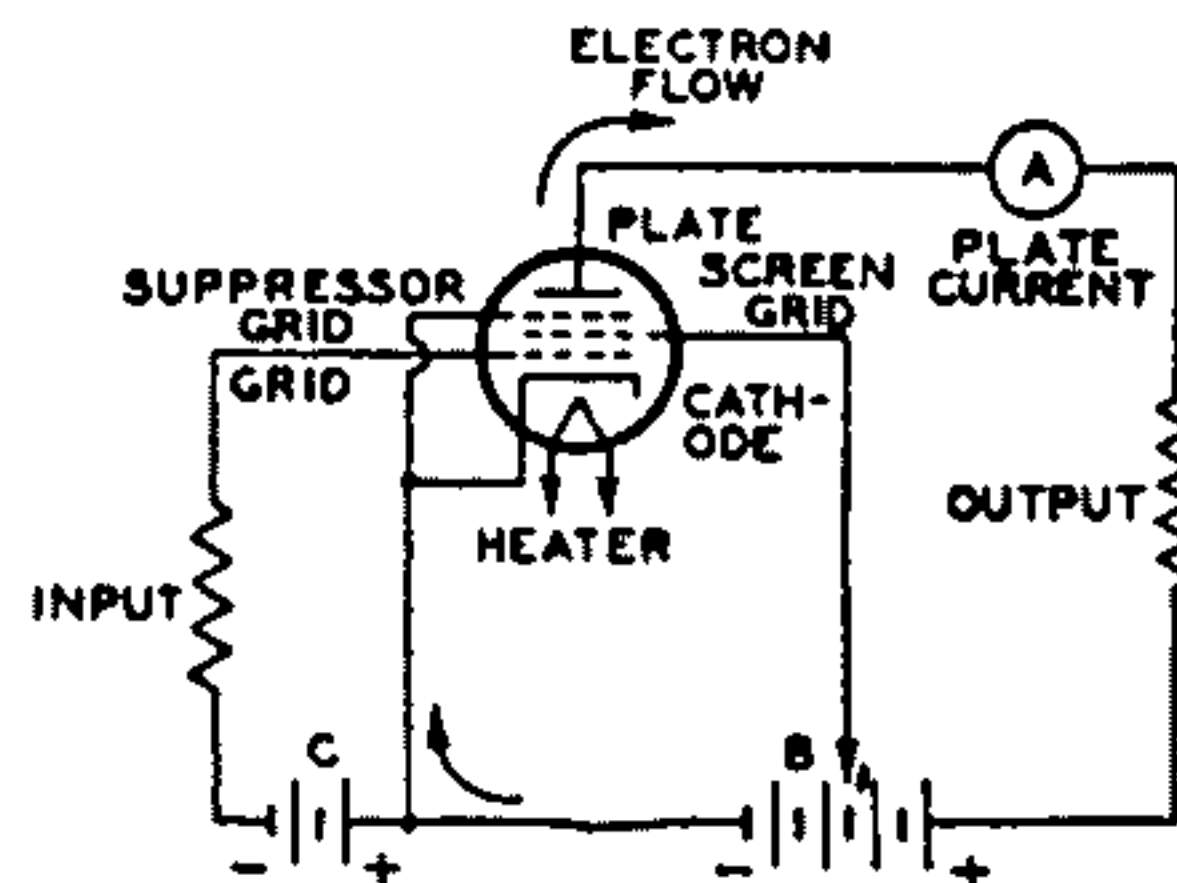


Fig. 8—Basic pentode circuit.



The family name for a five-electrode tube is "pentode." In power-output pentodes, the suppressor grid makes possible higher power output with lower grid-driving voltage; in radio-frequency amplifier pentodes, the suppressor grid makes possible high voltage amplification at moderate values of plate voltage. These desirable features result from the fact that the plate-voltage swing can be made very large. In fact, the plate voltage may be as low as, or lower than, the screen-grid voltage without serious loss in signal-gain capability. Representative pentodes used for power amplification are the 6CL6 and 6K6GT; representative pentodes used for voltage amplification are the 6AU6A, 6BA6, and 5879.

### Beam Power Tubes

A beam power tube is a tetrode or pentode in which directed electron beams are used to increase substantially the power-handling capability of the tube. Such a tube contains a cathode, a control grid (grid No. 1), a screen grid (grid No. 2), a plate, and, optionally, a suppressor grid (grid No. 3). When a beam power tube is designed without an actual suppressor grid, the electrodes are so spaced that secondary emission from the plate is suppressed by space-charge effects between screen grid and plate. The space charge is produced by the slowing up of electrons traveling from a high-potential screen grid to a lower-potential plate. In this low-velocity region, the space charge produced is sufficient to repel secondary electrons emitted from the plate and to cause them to return to the plate.

Beam power tubes of this design employ beam-confining electrodes at cathode potential to assist in producing the desired beam effects and to prevent stray electrons from the plate from returning to the screen grid outside of the beam. A feature of a beam power tube is its low screen-grid current. The screen grid and the control grid are spiral wires wound so that each turn of the screen grid is shaded from the cathode by a grid turn. This alignment of the screen

grid and control grid causes the electrons to travel in sheets between the turns of the screen grid so that very few of them strike the screen grid. Because of the effective suppressor action provided by space charge and because of the low current drawn by the screen grid, the beam power tube has the advantages of high power output, high power sensitivity, and high efficiency.

Fig. 9 shows the structure of a beam power tube employing space-charge suppression and illustrates how

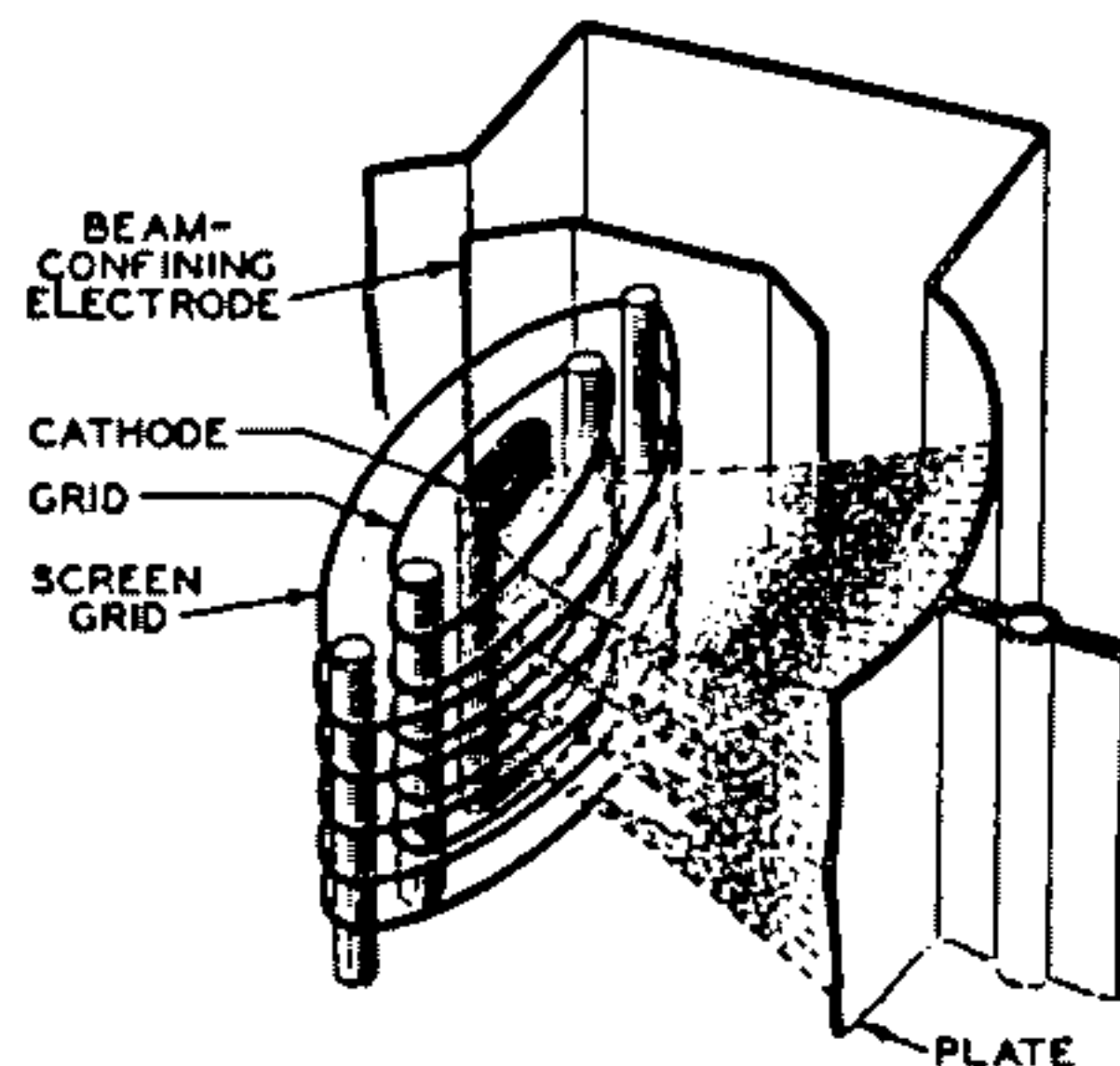


Fig. 9—Structure of beam power tube showing beam-confining action.

the electrons are confined to beams. The beam condition illustrated is that for a plate potential less than the screen-grid potential. The high-density space-charge region is indicated by the heavily dashed lines in the beam. Note that the edges of the beam-confining electrodes coincide with the dashed portion of the beam. In this way the space-charge potential region is extended beyond the beam boundaries and stray secondary electrons are prevented from returning to the screen grid outside of the beam. The space-charge effect may also be obtained by use of an actual suppressor grid. Examples of beam power tubes are 6AQ5A, 6L6GC, 6V6GTA, and 50C5.

### Multi-Electrode and Multi-Unit Tubes

Early in the history of tube devel-



opment and application, tubes were designed for a general service; that is, a single tube type—a triode—was used as a radio-frequency amplifier, an intermediate-frequency amplifier, an audio-frequency amplifier, an oscillator, or a detector. Obviously, with this diversity of application, one tube did not meet all requirements to the best advantage.

Later and present trends of tube design are the development of "specialty" types. These types are intended either to give optimum performance in a particular application or to combine in one bulb functions which formerly required two or more tubes. The first class of tubes includes such examples of specialty types as the 6CB6A and 6BY6. Types of this class generally require more than three electrodes to obtain the desired special characteristics and may be broadly classed as multi-electrode types. The 6BY6 is an especially interesting type in this class. This tube has an unusually large number of electrodes, namely seven, exclusive of the heater. Plate current in the tube is varied at two different frequencies at the same time. The tube is designed primarily for use as a combined sync separator and sync clipper in television receivers.

The second class includes multi-unit tubes such as the twin-diode triodes 6CN7 and 6AV6, as well as triode-pentodes such as the 6U8A and 6X8. This class also includes class A twin triodes such as the 6CG7 and 12AX7A, and types such as the 6CM7 containing dissimilar triode units used primarily as combined vertical oscillators and vertical deflection amplifiers in television receivers. Full-wave rectifiers are also multi-unit types.

A third class of tubes combines features of each of the other two classes. Typical of this third class are the pentagrid-converter types 6BE6 and 6SA7. These tubes are similar to the multi-electrode types in that they have seven electrodes, all of which affect the electron stream; and they are similar to the multi-unit tubes in that they perform simultaneously the double function of oscillator and mixer in superheterodyne receivers.

## Receiving Tube Structure

Receiving tubes generally utilize a glass or metal envelope and a base. Originally, the base was made of metal or molded phenolic material. Types having a glass envelope and a molded phenolic base include the "octal" types such as the 5U4GB and the 6SN7GTB. Types having a metal envelope and molded phenolic octal base include the 6F6 and the 6L6. Many modern types utilize integral glass bases. Present-day conventional tube designs utilizing glass envelopes and integral glass bases include the seven-pin and nine-pin miniature types, the nine-pin novar and neonoval types, and the twelve-pin duodecar types. Examples of the seven-pin miniature types are the 6AU6A and 6BN6. Examples of the nine-pin miniature types are the 12AU7A and 6EA8. Examples of the novar types are the 6BH3 and 7868. The nine-pin base for the novar types has a relatively large pin-circle diameter and long pins to insure firm retention of the tube in its socket.

The *nuvistor* concept provided a new approach to electron tube design. Nuvistor tubes utilize a light-weight cantilever-supported cylindrical electrode structure housed in a ceramic-metal envelope. These tubes combine new materials, processes, and fabrication techniques. Examples of the *nuvistor* are the 6CW4 and the 6DV4.

## Television Picture Tubes

The picture tube, or kinescope, is a multi-electrode tube used principally in television receivers for picture display. It consists essentially of an electron gun, a glass or metal-and-glass envelope and face-plate combination, and a fluorescent screen.

The electron gun includes a cathode for the production of free electrons, one or more control electrodes for accelerating the electrons in the beam, and, optionally, a device for "trapping" unwanted ions out of the electron beam.

Focusing of the beam is accomplished either electromagnetically by



means of a focusing coil placed on the neck of the tube, or electrostatically, as shown in Fig. 10, by means of a focusing electrode (grid No. 4) within the envelope of the tube. The screen is a white-fluorescing phosphor P4 of either the silicate or the sulfide type.

Deflection of the beam is accomplished either electrostatically by means of deflecting electrodes within the envelope of the tube, or electromagnetically by means of a deflecting yoke placed on the neck of the tube. Fig. 10 shows the structure of the gun section of a picture tube and illustrates how the electron beam is formed and how the beam is deflected by means of an electromagnetic deflecting yoke. In this type of tube, ions in the beam are prevented from damaging the fluorescent screen by an aluminum film on the gun side of the screen. This film not only "traps" unwanted ions, but also improves picture contrast. In many types of non-aluminized tubes, ions are separated from the electron beam by means of a tilted-gun and ion-trap-magnet arrangement.

Color television picture tubes are similar to black-and-white picture tubes, but differ in three major ways: (1) The light-emitting screen is made up of trios

of phosphor dots deposited in an interlaced pattern. Each dot of a trio is capable of emitting light in one of the three primary colors (red, green, or blue). (2) A shadow mask mounted near the screen of the tube contains over 300,000 apertures, one for each of the phosphor dot trios. This mask provides color separation by shadowing two of the three phosphor dots of each trio. (3) Three closely spaced electron guns, built as a unit, provide separate beams for excitation of the three different color-phosphor-dot arrays. Thus it is possible to control the brightness of each of the three colors independently of the other two. Fig. 11 shows a cut-away view of a color television picture tube.

The three electron guns are mounted with their axes tilted toward the central axis of the envelope, and are spaced 120 degrees with respect to each other. The focusing electrodes of the three guns are interconnected internally, and their potential is adjusted to cause the separate beams to focus at the phosphor-dot screen. All three beams must be made to converge at the screen while they are simultaneously being deflected. Convergence is accomplished by the action of static and

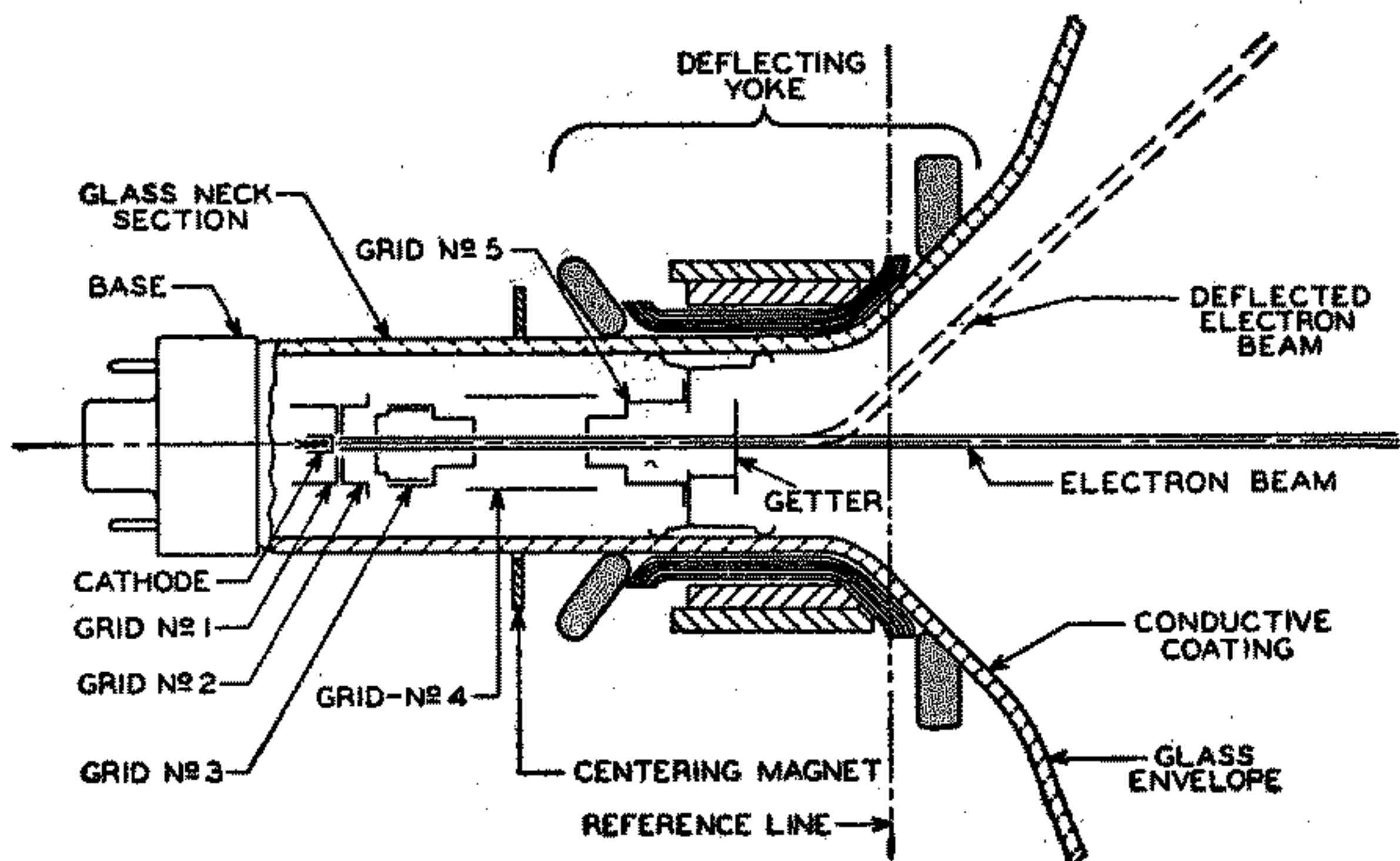


Fig. 10—Structure of television-picture-tube electron gun.



dynamic magnetic fields set up by the radial-converging magnet assembly mounted on the neck of the tube. These fields are coupled into the radial-converging pole pieces within the tube. Another pair of pole pieces in the tube is activated by the lateral-converging magnet also mounted on the neck of the tube. These pole pieces permit lateral shift in position of the blue beam in opposition to the lateral shift of the green and red beams.

A purifying magnet is used with color picture tubes to provide a magnetic field, adjustable in magnitude and direction, to effect register over the entire area of the screen. A magnetic shield is used to minimize the effects of the earth's magnetic field.

Deflection of the three beams is accomplished simultaneously by a deflecting yoke using four electromagnetic coils similar to the deflecting yoke used for black-and-white picture tubes.

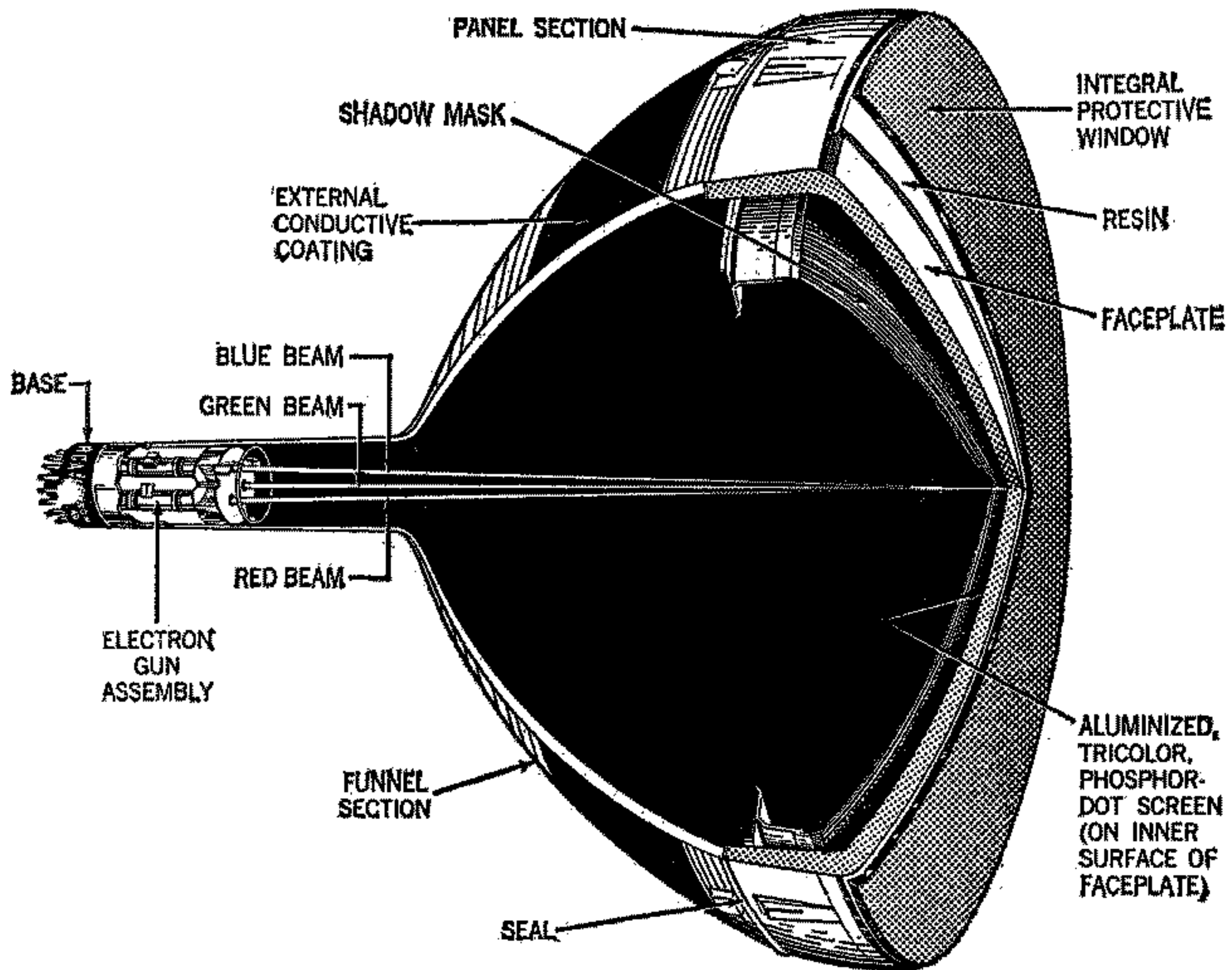


Fig. 11—Cutaway view of color television picture tube.



# Electron Tube Characteristics

**T**HE term "characteristics" is used to identify the distinguishing electrical features and values of an electron tube. These values may be shown in curve form or they may be tabulated. When the characteristics values are given in curve form, the curves may be used for the determination of tube performance and the calculation of additional tube factors.

Tube characteristics are obtained from electrical measurements of a tube in various circuits under certain definite conditions of voltages. Characteristics may be further described by denoting the conditions of measurements. For example, Static Characteristics are the values obtained with different dc potentials applied to the tube electrodes, while Dynamic Characteristics are the values obtained with an ac voltage on a control grid under various conditions of dc potentials on the electrodes. The dynamic characteristics, therefore, are indicative of the performance capabilities of a tube under actual working conditions.

Static characteristics may be shown by plate characteristics curves and transfer (mutual) characteristics curves. These curves present the same information, but in two different forms to increase its usefulness. The plate characteristic curve is obtained by varying plate voltage and measuring plate current for different grid-bias voltages, while the transfer-characteristic curve is obtained by varying grid-bias voltage and measuring plate current for different plate voltages. A plate-characteristic family of curves is shown in Fig. 12. Fig. 13 gives the transfer-characteristic family of curves for the same tube.

Dynamic characteristics include amplification factor, plate resistance, control-grid—plate transconductance, and certain detector characteristics, and may be shown in curve form for variations in tube operating conditions.

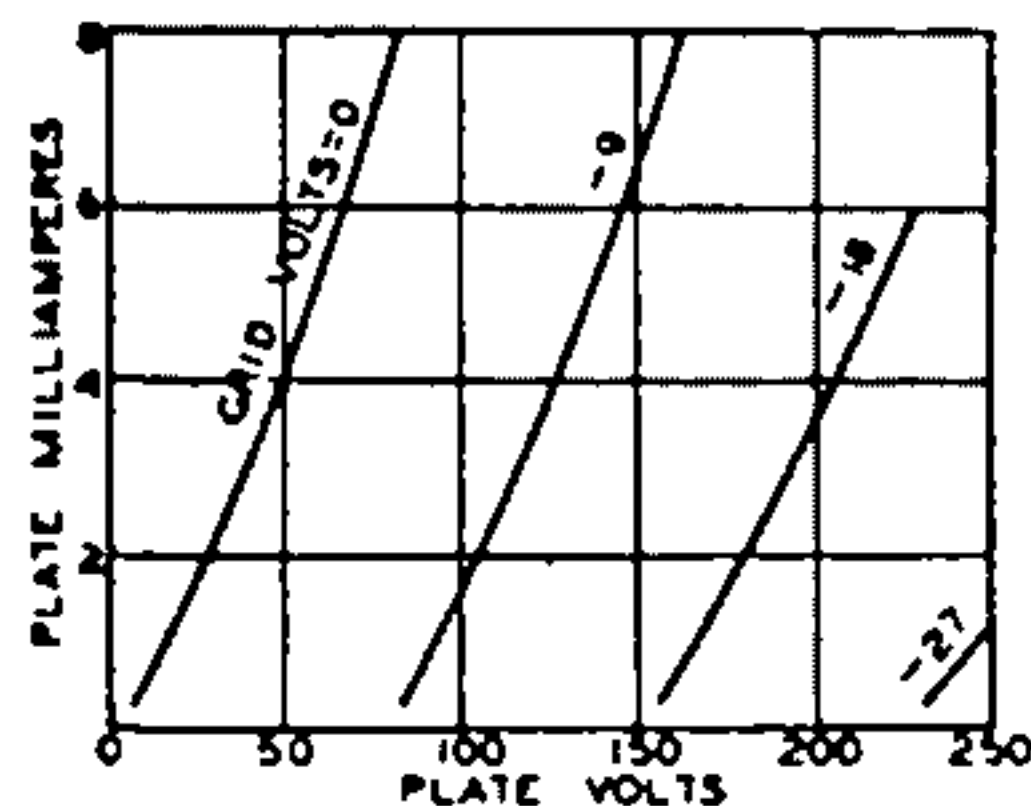


Fig. 12—Family of plate-characteristics curves.

The amplification factor, or  $\mu$ , is the ratio of the change in plate voltage to a change in control-electrode voltage in the opposite direction, under the condition that the plate current remains

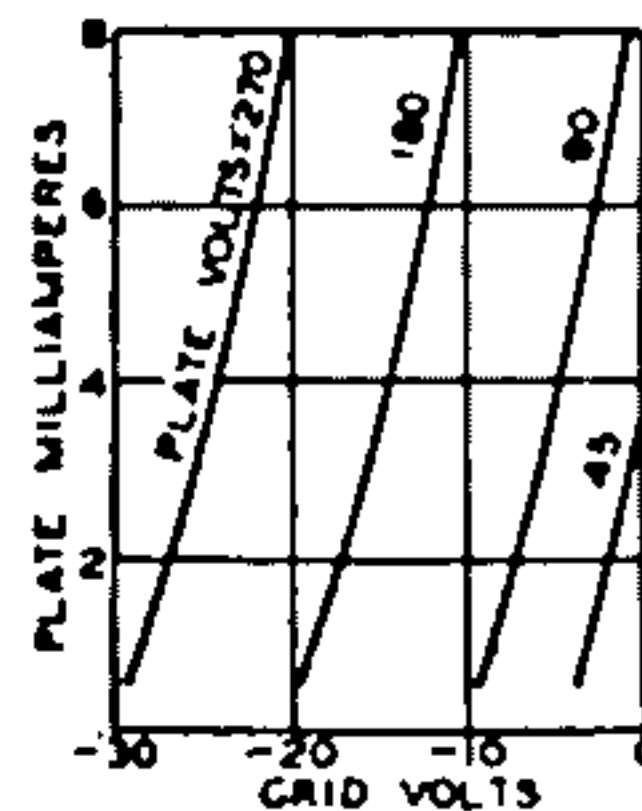


Fig. 13—Family of transfer-characteristics curves.

unchanged and that all other electrode voltages are maintained constant. For example; if, when the plate voltage



is made 1 volt more positive, the control-electrode (grid-No. 1) voltage must be made 0.1 volt more negative to hold plate current unchanged, the amplification factor is 1 divided by 0.1, or 10. In other words, a small voltage variation in the grid circuit of a tube has the same effect on the plate current as a large plate-voltage change—the latter equal to the product of the grid-voltage change and amplification factor. The  $\mu$  of a tube is often useful for calculating stage gain. This use is discussed in the **Electron Tube Applications** section.

**Plate resistance ( $r_p$ )** of an electron tube is the resistance of the path between cathode and plate to the flow of alternating current. It is the quotient of a small change in plate voltage divided by the corresponding change in plate current and is expressed in ohms, the unit of resistance. Thus, if a change of 0.1 milliamperes (0.0001 ampere) is produced by a plate-voltage variation of 1 volt, the plate resistance is 1 divided by 0.0001, or 10000 ohms.

**Control-grid—plate transconductance, or simply transconductance ( $g_m$ )**, is a factor which combines in one term the amplification factor and the plate resistance, and is the quotient of the first divided by the second. This term has also been known as mutual conductance. Transconductance may be more strictly defined as the quotient of a small change in plate current (amperes) divided by the small change in the control-grid voltage producing it, under the condition that all other voltages remain unchanged. Thus, if a grid-

voltage change of 0.5 volt causes a plate-current change of 1 milliamperes (0.001 ampere), with all other voltages constant, the transconductance is 0.001 divided by 0.5, or 0.002 mho. A "mho" is the unit of conductance and was named by spelling ohm backwards. For convenience, a millionth of a mho, or a micromho ( $\mu$ mho), is used to express transconductance. Thus, in the example, 0.002 mho is 2000 micromhos.

**Conversion transconductance ( $g_c$ )** is a characteristic associated with the mixer (first detector) function of tubes and may be defined as the quotient of the intermediate-frequency (if) current in the primary of the if transformer divided by the applied radio-frequency (rf) voltage producing it; more precisely, it is the limiting value of this quotient as the rf voltage and if current approach zero. When the performance of a frequency converter is determined, conversion transconductance is used in the same way as control-grid—plate transconductance is used in single-frequency amplifier computations:

The **plate efficiency** of a power amplifier tube is the ratio of the ac power output ( $P_o$ ) to the product of the average dc plate voltage ( $E_b$ ) and dc plate current ( $I_b$ ) at full signal, or

$$\text{Plate efficiency} = \frac{P_o \text{ watts}}{E_b \text{ volts} \times I_b \text{ amperes}} \times 100\%$$

The **power sensitivity** of a tube is the ratio of the power output to the square of the input signal voltage ( $E_{i.a}$ ), and is expressed in mhos as follows:

$$\text{Power sensitivity (mhos)} = \frac{P_o \text{ watts}}{(E_{i.a} \text{ rms})^2}$$



# Electron Tube Applications

**T**HE diversified applications of an electron receiving tube have, within the scope of this section, been treated under seven headings: Rectification; Detection; Amplification; TV Scanning, Sync, and Deflection; Oscillation; Frequency Conversion; and Tuning Indication with Electron-Ray Tubes. Although these operations may take place at either radio or audio frequencies and may involve the use of different circuits and different supplemental parts, the general considerations of each kind of operation are basic.

## General System Functions

When speech, music, or video information is transmitted from a radio or television station, the station radiates a modulated radio-frequency (rf) carrier. The function of a radio or television receiver is simply to reproduce the modulating wave from the modulated carrier.

As shown in Fig. 14, a superheterodyne radio receiver picks up the transmitted modulated rf signal, amplifies it and converts it to a modulated intermediate-frequency (if) signal, amplifies the modulated if signal, separates the modulating signal from the basic carrier wave, and amplifies the resulting

audio signal to a level sufficient to produce the desired volume in a speaker. In addition, the receiver usually includes some means of producing automatic gain control (agc) of the modulated signal before the audio information is separated from the carrier.

The transmitted rf signal picked up by the radio receiver may contain either amplitude modulation (AM) or frequency modulation (FM). (These modulation techniques are described later in the section on **Detection**.) In either case, amplification prior to the detector stage is performed by tuned amplifier circuits designed for the proper frequency and bandwidth. Frequency conversion is performed by mixer and oscillator circuits or by a single converter stage which performs both mixer and oscillator functions. Separation of the modulating signal is normally accomplished by one or more diodes in a detector or discriminator circuit. Amplification of the audio signal is then performed by one or more audio amplifier stages:

Audio-amplifier systems for phonograph or tape recordings are similar to the stages after detection in a radio receiver. The input to the amplifier is a low-power-level audio signal from the

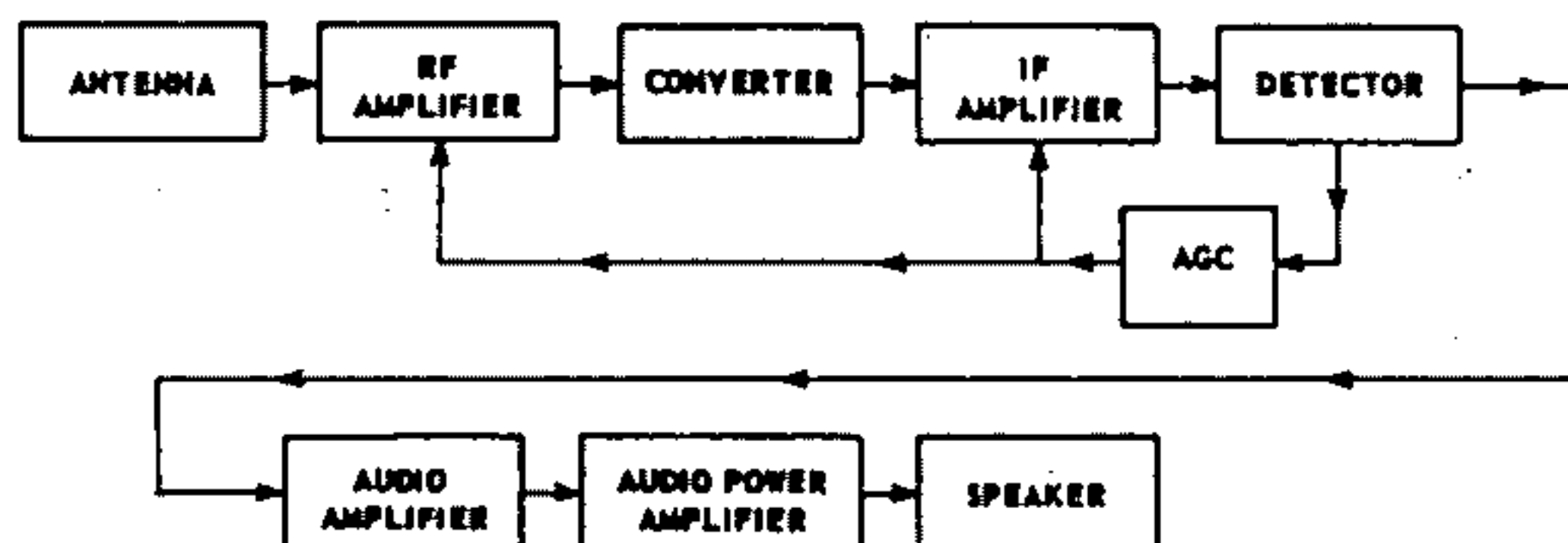


Fig. 14—Simplified block diagram for a broadcast-band receiver.



phonograph or magnetic-tape pickup head. This signal is usually amplified through a preamplifier stage, one or more low-level (pre-driver or driver) audio stages, and an audio power amplifier. The system may also include frequency-selective circuits which act as equalization networks and/or tone controls.

The operation of a television receiver is more complex than that of a radio receiver, as shown by the simplified block diagram in Fig. 15. The tuner section of the receiver selects the proper rf signals for the desired channel frequency, amplifies them, and converts them to a lower intermediate frequency.

and thus controls instantaneous "spot" brightness. At the same time, deflection circuits cause the electron beam of the picture tube to move the "spot" across the faceplate horizontally and vertically. Special "sync" signals derived from the video signal assure that the horizontal and vertical scanning are timed so that the picture produced on the receiver exactly duplicates the picture being viewed by the camera or pickup tube.

A communications transceiver contains transmitting circuits, as well as receiving circuits similar to those of a radio receiver. The transmitter portion of such a system consists of two sections.

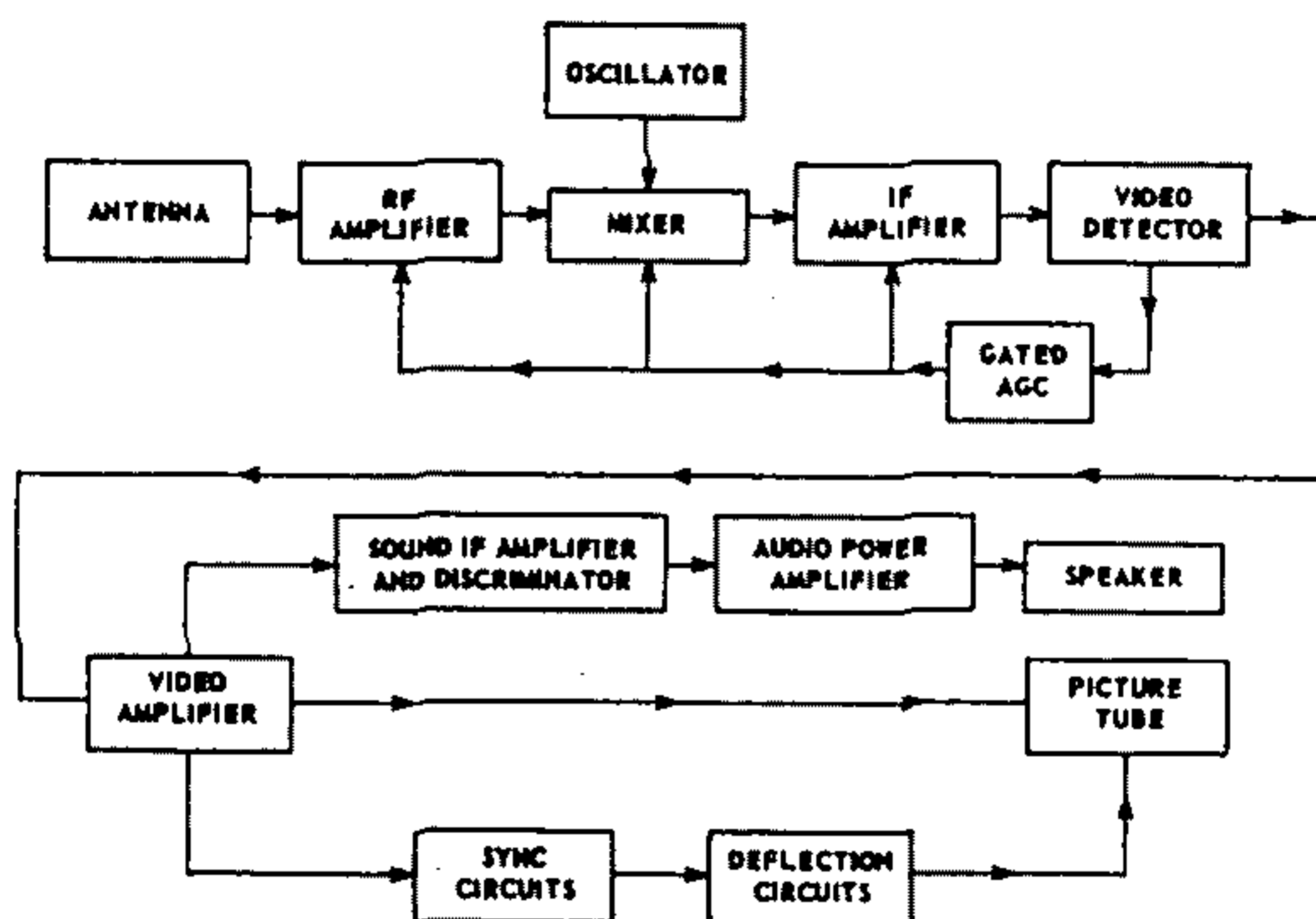


Fig. 15—Simplified block diagram for a television receiver.

As in a radio, these functions are accomplished in rf-amplifier, mixer, and local-oscillator stages. The if signal is then amplified in if-amplifier stages which provide the additional gain required to bring the signal level to an amplitude suitable for detection.

After if amplification, the detected signal is separated into sound and picture information. The sound signal is amplified and processed to provide an audio signal which is fed to an audio amplifier system similar to those described above. The picture (video) signal is passed through a video amplifier stage which conveys beam-intensity information to the television picture tube

In one section, the desired intelligence (voice, code, or the like) is picked up and amplified through one or more amplifier stages (which are usually common to the receiver portion) to a high-level stage called a modulator. In the other section, an rf signal of the desired frequency is developed in an oscillator stage and amplified in one or more rf-amplifier stages. The audio-frequency (af) modulating signal is impressed on the rf carrier in the final rf-power-amplifier stage (high-level modulation), in the rf low-level stage (low-level modulation), or in both. Fig. 16 shows a simplified block diagram of the transmitter portion of a citizens-band trans-



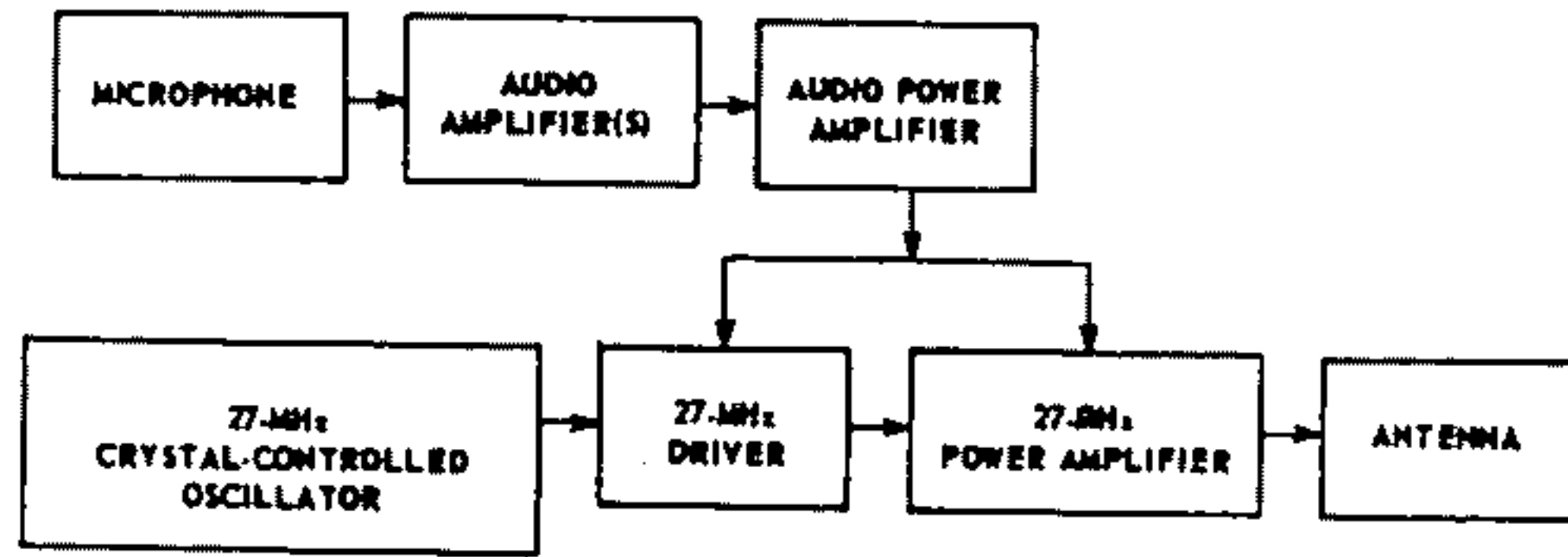


Fig. 16—Simplified block diagram for the transmitter portion of a 27-MHz communications receiver.

ceiver that operates at a frequency of 27 MHz (megacycles per second). The transmitting section of a communications system may also include frequency-multiplier circuits which raise the frequency of the developed rf signal as required.

**Rectification**

The rectifying action of a diode finds important applications in supplying a receiver with dc power from an ac line and in supplying high dc voltage from a high-voltage pulse. A typical arrangement for converting ac to dc includes a rectifier tube, a filter, and a voltage divider. The rectifying action of the tube is explained briefly under **Diodes**, in the **Electrons, Electrodes, and Electron Tubes** section. High-voltage pulse rectification is described later under **Horizontal Output Circuits**.

The function of a filter is to smooth out the ripple of the tube output, as indicated in Fig. 17, and to

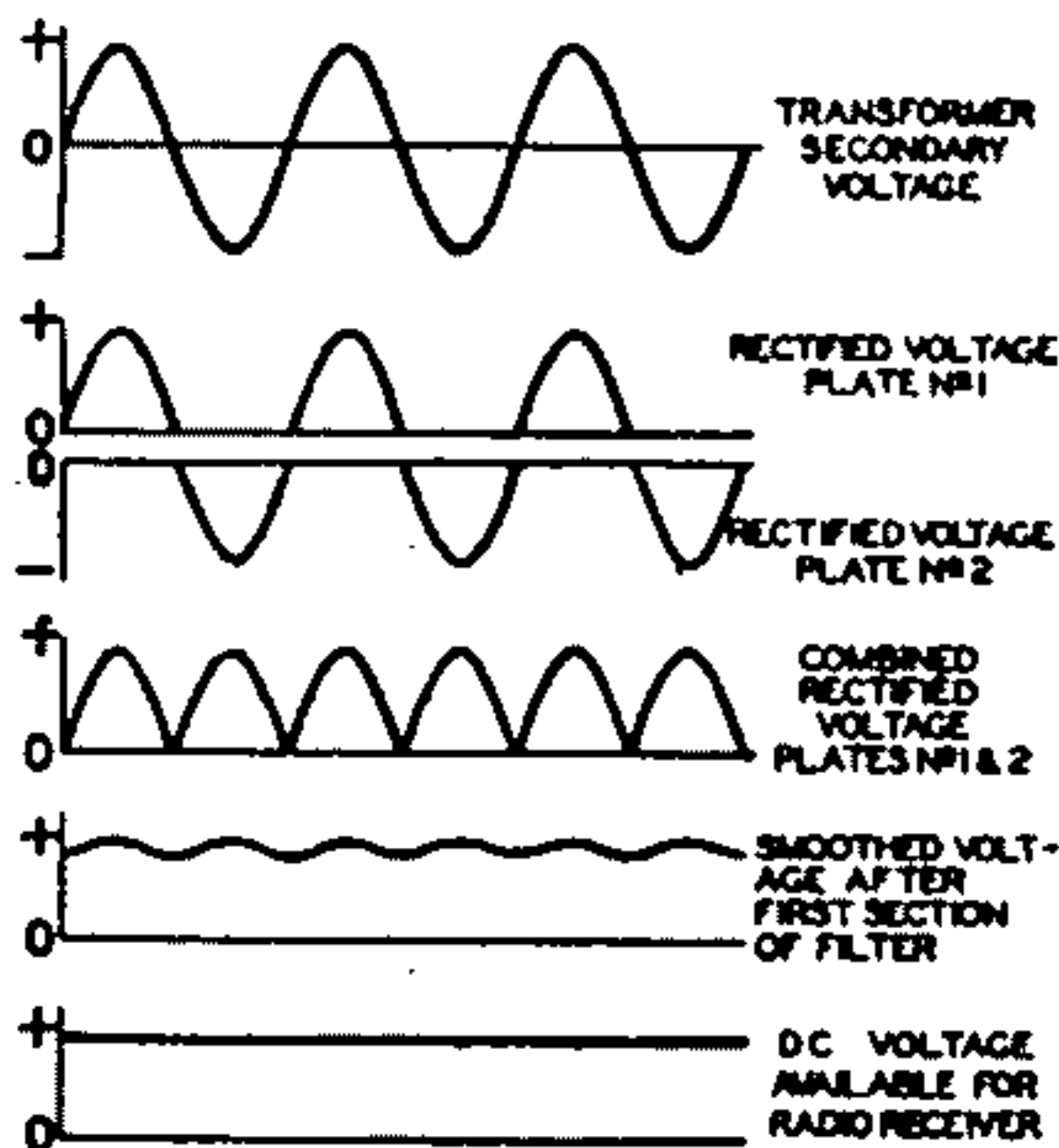


Fig. 17—Voltage waveforms of full-wave rectifier circuit.

increase rectifier efficiency. The action of the filter is explained in the **Electron Tube Installation** section under **Filters**. The voltage divider is used to cut down the output voltage to the values required by the plates and the other electrodes of the tubes in the receiver.

A half-wave rectifier and a full-wave rectifier circuit are shown in Fig. 18. In the half-wave circuit, current

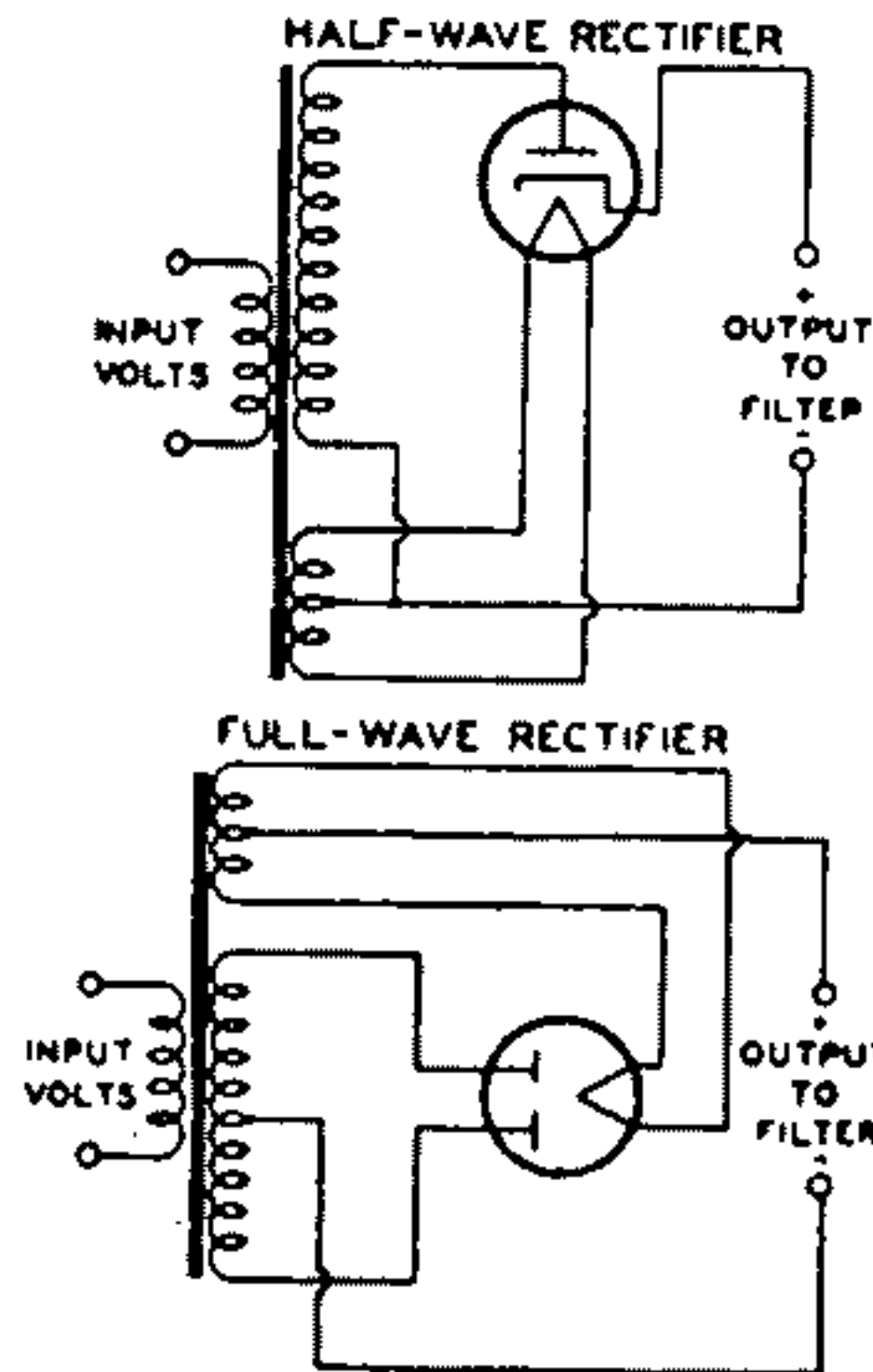


Fig. 18—Half-wave and full-wave rectifier circuits.

flows through the rectifier tube to the filter on every other half-cycle of the ac input voltage when the plate is positive with respect to the cathode. In the full-wave circuit, current flows to the filter on every half-cycle, through plate No. 1 on one half-cycle when plate No. 1 is positive with respect to the cathode, and through plate No. 2 on the next half-cycle when plate No. 2 is positive with respect to the cathode.



Because the current flow to the filter is more uniform in the full-wave circuit than in the half-wave circuit, the output of the full-wave circuit requires less filtering. Rectifier operating information and circuits are given under each rectifier tube type and in the **Circuits** section, respectively.

**Parallel operation** of rectifier tubes furnishes an output current greater than that obtainable with the use of one tube. For example, when two full-wave rectifier tubes are connected in parallel, the plates of each tube are connected together and each tube acts as a half-wave rectifier. The permissible voltage and load conditions per tube are the same as for full-wave service but the total load-handling capability of the complete rectifier is approximately doubled.

When mercury-vapor rectifier tubes are connected in parallel, a stabilizing resistor of 50 to 100 ohms should be connected in series with each plate lead in order that each tube will carry an equal share of the load. The value of the resistor to be used will depend on the amount of plate current that passes through the rectifier. Low plate current requires a high value; high plate current, a low value. When the plates of mercury-vapor rectifier tubes are connected in parallel, the corresponding filament leads should be similarly connected. Otherwise, the tube drops will be considerably unbalanced and larger stabilizing resistors will be required.

Two or more vacuum rectifier tubes can also be connected in parallel to give correspondingly higher output current and, as a result of paralleling their internal resistances, give somewhat increased voltage output. With vacuum types, stabilizing resistors may or may not be necessary depending on the tube type and the circuit.

A **voltage-doubler** circuit of simple form is shown in Fig. 19. The circuit derives its name from the fact that its dc voltage output can be as high as twice the peak value of ac input. Basically, a voltage doubler is a rectifier circuit arranged so that the output voltages of two half-wave rectifiers are in series.

The action of a voltage doubler can be described briefly as follows. On the positive half-cycle of the ac input, that is, when the upper side of the ac input line is positive with respect to the lower side, the upper diode passes current and feeds a positive charge into the upper capacitor. As positive charge accumulates on the upper plate of the capacitor, a positive voltage builds up across the capacitor. On the next half-cycle of the ac input, when the upper side of the line is negative with respect to the lower side, the lower diode passes current so that

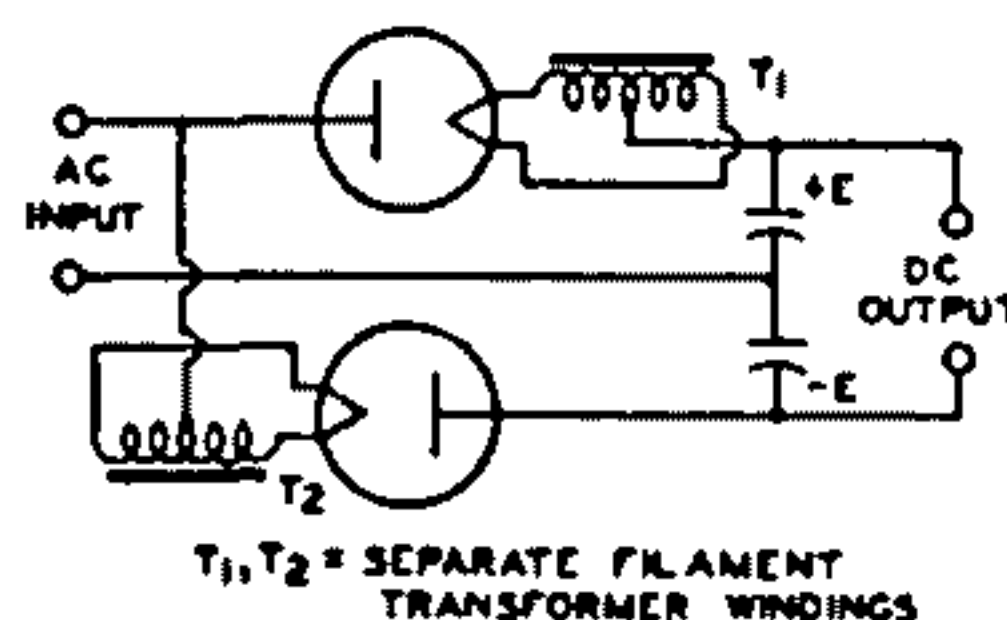


Fig. 19—Full-wave voltage-doubler circuit.

a negative voltage builds up across the lower capacitor.

So long as no current is drawn at the output terminals from the capacitor, each capacitor can charge up to a voltage of magnitude  $E$ , the peak value of the ac input. It can be seen from the diagram that with a voltage of  $+E$  on one capacitor and  $-E$  on the other, the total voltage across the capacitors is  $2E$ . Thus the voltage doubler supplies a no-load dc output voltage twice as large as the peak ac input voltage. When current is drawn at the output terminals by the load, the output voltage drops below  $2E$  by an amount that depends on the magnitude of the load current and the capacitance of the capacitors. The arrangement shown in Fig. 19 is called a full-wave voltage doubler because each rectifier passes current to the load on each half of the ac input cycle.

Two rectifier types especially designed for use as voltage doublers are the 25Z6GT and 117Z6GT. These tubes combine two separate diodes in one tube. As voltage doublers, the tubes are used in "transformerless" receivers. In these receivers, the heaters of all tubes

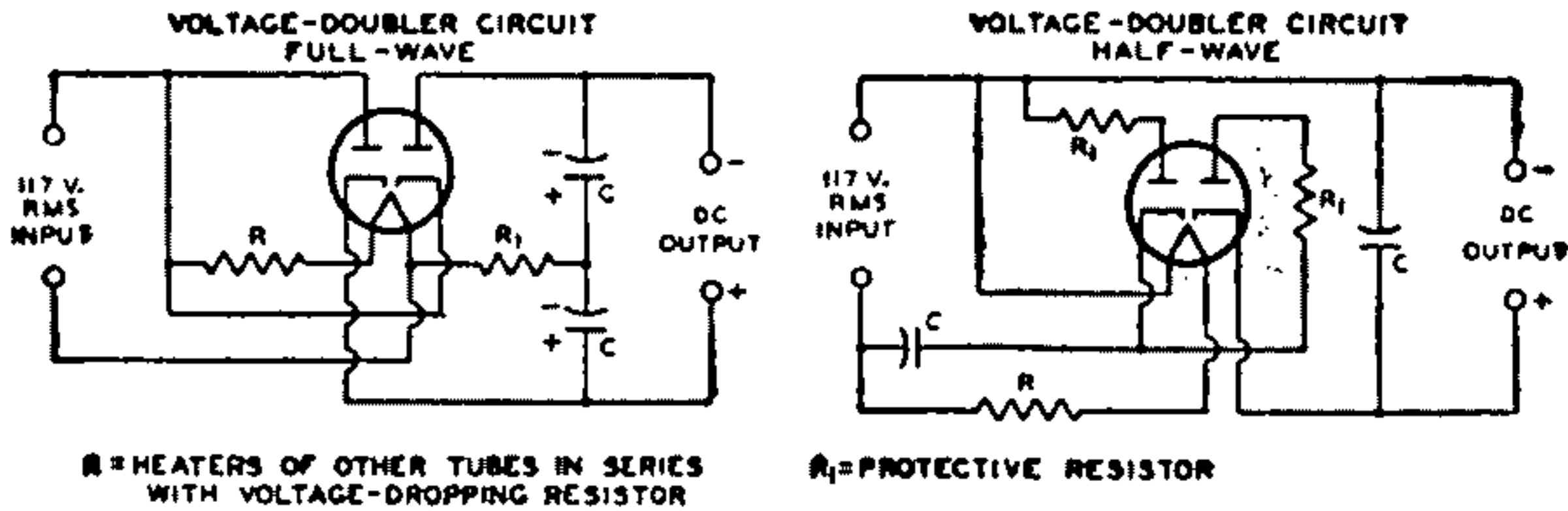


Fig. 20—Full-wave and half-wave voltage-doubler circuits showing heater-supply connections.

in the set are connected in series with a voltage-dropping resistor across the line. The connections for the heater supply and the voltage-doubling circuit are shown in Fig. 20.

With the full-wave voltage-doubler circuit in Fig. 20, it will be noted that the dc load circuit can not be connected to ground or to one side of the ac supply line. This circuit presents certain disadvantages when the heaters of all the tubes in the set are connected in series with a resistance across the ac line. Such a circuit arrangement may cause hum because of the high ac potential between the heaters and cathodes of the tubes.

The half-wave voltage-doubler circuit in Fig. 20 overcomes this difficulty by making one side of the ac line common with the negative side of the dc load circuit. In this circuit, one half of the tube is used to charge a capacitor which, on the following half cycle, discharges in series with the line voltage through the other half of the tube. This circuit is called a half-wave voltage doubler because rectified current flows to the load only on alternate halves of the ac input cycle. The voltage regulation of this arrangement is somewhat poorer than that of the full-wave voltage doubler.

### Detection

When speech, music, or video information is transmitted from a radio or television station, the station radiates a radio-frequency (rf) wave which is of either of two general types. In one type, the wave is said to be amplitude modulated when its frequency remains constant and the amplitude is varied. In the other type, the wave is said to be frequency modulated when its amplitude remains essentially constant but its frequency is varied.

The function of the receiver is to reproduce the original modulating wave from the modulated rf wave. The receiver stage in which this function is performed is called the demodulator or detector stage.

#### AM Detection

The effect of amplitude modulation on the waveform of the rf wave is shown in Fig. 21. There are three different basic circuits used for the detection of amplitude-modulated waves: the diode detector, the grid-bias detector, and the grid-resistor detector. These circuits are alike in that they eliminate, either partially or completely, alternate half-cycles of the rf wave. With alternate half-cycles removed, the audio variations of the other half-cycles can be

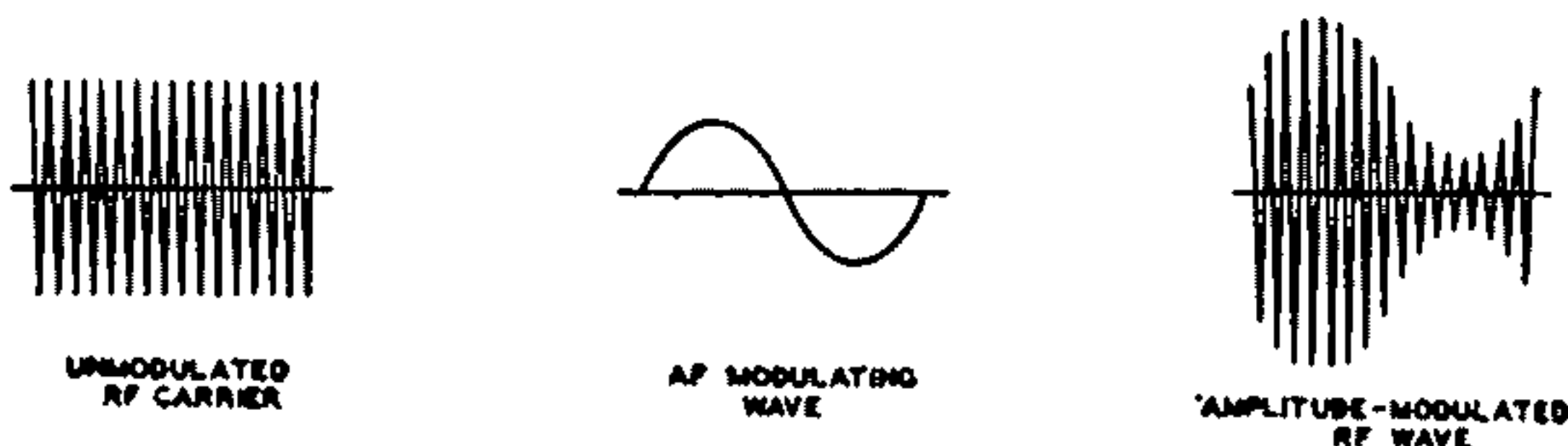


Fig. 21—Waveforms showing effect of amplitude modulation on an rf wave.



amplified to drive headphones or a loud-speaker.

A diode-detector circuit is shown in Fig. 22. The action of this circuit when a modulated rf wave is applied is

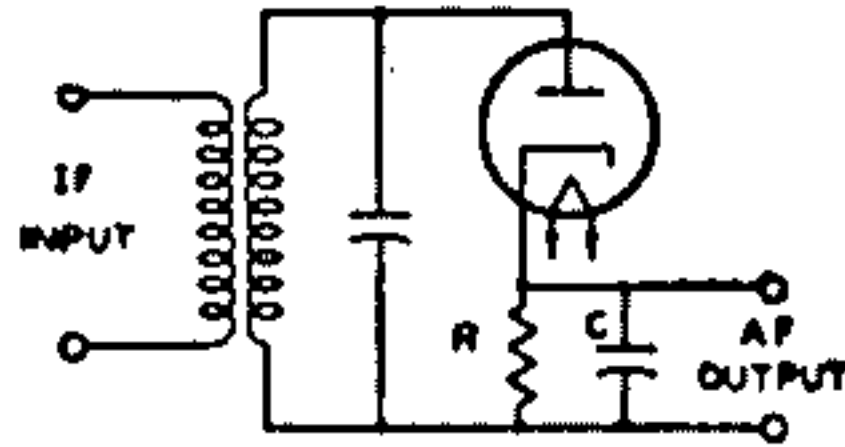


Fig. 22—Basic diode-detector circuit. illustrated by Fig. 23. The rf voltage applied to the circuit is shown in light line; the output voltage across capacitor C is shown in heavy line.

Between points (a) and (b) on the first positive half-cycle of the applied rf voltage, capacitor C charges up to the peak value of the rf voltage. Then as the applied rf voltage falls away from its peak value, the capacitor holds the cathode at a potential more positive than the voltage applied to the anode.

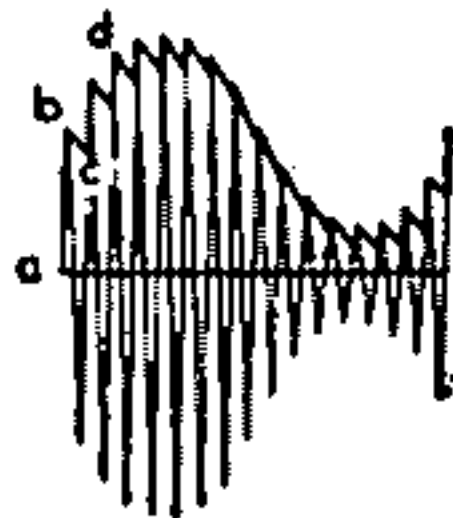


Fig. 23—Waveforms showing modulated rf input (light line) and output voltage (heavy line) of diode-detector circuit.

The capacitor thus temporarily cuts off current through the diode. While the diode current is cut off, the capacitor discharges from (b) to (c) through the diode load resistor R.

When the rf voltage on the anode rises high enough to exceed the potential at which the capacitor holds the cathode, current flows again and the capacitor charges up to the peak value of the second positive half-cycle at (d). In this way, the voltage across the capacitor follows the peak value of the applied rf voltage and reproduces the af modulation.

The curve for voltage across the capacitor, as shown in Fig. 23, is somewhat jagged. However, this jaggedness, which represents an rf component in the voltage across the capacitor, is

exaggerated in the drawing. In an actual circuit the rf component of the voltage across the capacitor is negligible. Hence, when the voltage across the capacitor is amplified, the output of the amplifier reproduces the speech or music originating at the transmitting station.

Another way to describe the action of a diode detector is to consider the circuit as a half-wave rectifier. When the rf signal on the plate swings positive, the tube conducts and the rectified current flows through the load resistance R. Because the dc output voltage of a rectifier depends on the voltage of the ac input, the dc voltage across C varies in accordance with the amplitude of the rf carrier and thus reproduces the af signal. Capacitor C should be large enough to smooth out rf or if variations, but should not be so large as to affect the audio variations. Two diodes can be connected in a circuit similar to a full-wave rectifier to provide full-wave detection. However, in practice, the advantages of this connection generally do not justify the extra circuit complication.

The diode method of detection produces less distortion than other methods because the dynamic characteristics of a diode can be made more linear than those of other detectors. The disadvantages of a diode are that it does not amplify the signal, and that it draws current from the input circuit and therefore reduces the selectivity of the input circuit. However, because the diode method of detection produces less distortion and because it permits the use of simple avc circuits without the necessity for an additional voltage supply, the diode method of detection is most widely used in broadcast receivers.

A typical diode-detector circuit using a twin-diode—triode tube is shown in Fig. 24. Both diodes are connected together.  $R_1$  is the diode load resistor. A portion of the af voltage developed across this resistor is applied to the triode grid through the volume control  $R_2$ . In a typical circuit, resistor  $R_1$  may be tapped so that five-sixths of the total af voltage across  $R_1$  is applied to the volume control. This tapped connection reduces the af voltage output

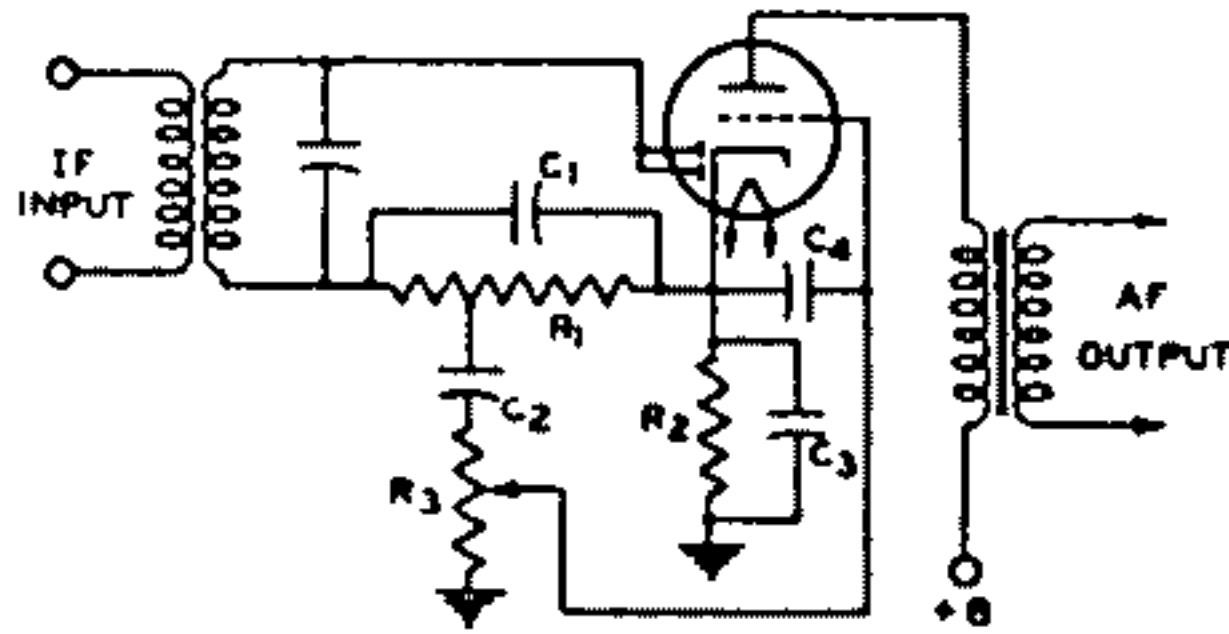


Fig. 24—Typical diode-detector circuit using a twin diode—triode tube.

of the detector circuit slightly, but it reduces audio distortion and improves the rf filtering.

DC bias for the triode section is provided by the cathode-bias resistor  $R_3$  and the audio bypass capacitor  $C_4$ . The function of capacitor  $C_2$  is to block the dc bias of the cathode from the grid. The function of capacitor  $C_4$  is to bypass any rf voltage on the grid to cathode. A twin-diode—pentode may also be used in this circuit. With a pentode, the af output should be resistance-coupled rather than transformer-coupled.

Another diode-detector circuit, called a diode-biased circuit, is shown in Fig. 25. In this circuit, the triode grid

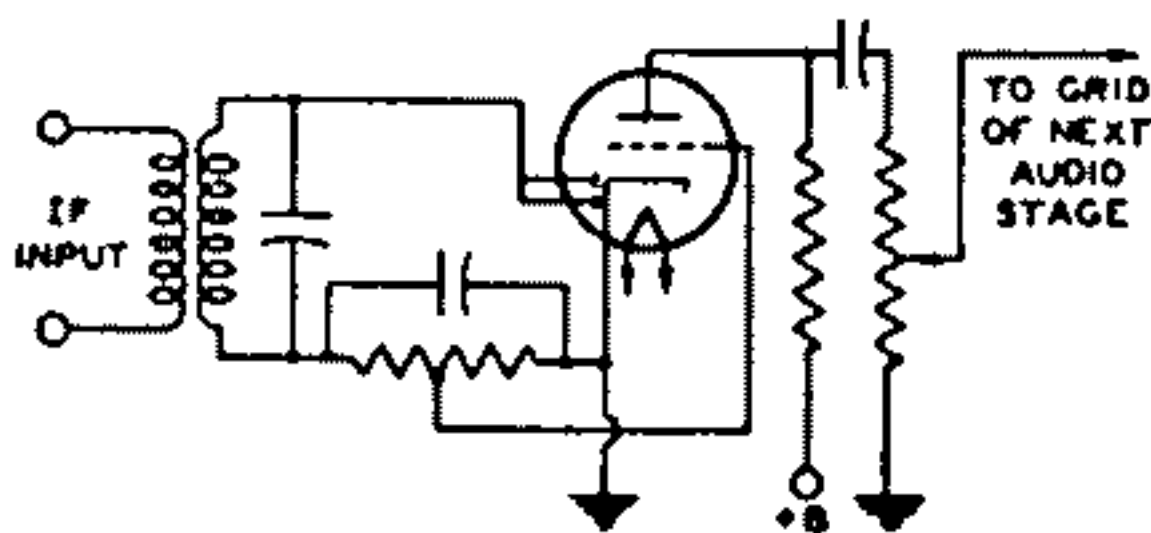


Fig. 25—Diode-biased detector circuit.

is connected directly to a tap on the diode load resistor. When an rf signal voltage is applied to the diode, the dc voltage at the tap supplies bias to the triode grid. When the rf signal is modulated, the af voltage at the tap is applied to the grid and is amplified by the triode.

The advantage of the circuit shown in Fig. 25 over the self-biased arrangement shown in Fig. 24 is that the diode-biased circuit does not employ a capacitor between the grid and the diode load resistor, and consequently does not produce as much distortion of a signal having a high percentage of modulation.

However, there are restrictions on

the use of the diode-biased circuit. Because the bias voltage on the triode depends on the average amplitude of the rf voltage applied to the diode, the average amplitude of the voltage applied to the diode should be constant for all values of signal strength at the antenna. Otherwise there will be different values of bias on the triode grid for different signal strengths and the triode will produce distortion. Because there is no bias applied to the diode-biased triode when no rf voltage is applied to the diode, sufficient resistance should be included in the plate circuit of the triode to limit its zero-bias plate current to a safe value.

These restrictions mean, in practice, that the receiver should have a separate-channel automatic-volume-control (avc) system. With such an avc system, the average amplitude of the signal voltage applied to the diode can be held within very close limits for all values of signal strength at the antenna.

The tube used in a diode-biased circuit should be one which operates at a fairly large value of bias voltage. The variations in bias voltage are then a small percentage of the total bias and hence produce small distortion. Tubes taking a fairly large bias voltage are types such as the 6BF6 or 6SR7 having a medium- $\mu$  triode. Tube types having a high- $\mu$  triode or a pentode should not be used in a diode-biased circuit.

A **grid-bias detector** circuit is shown in Fig. 26. In this circuit, the grid is biased almost to cutoff, *i.e.*, operated so that the plate current with zero signal is practically zero. The bias voltage can be obtained from a cathode-bias resistor, a C-battery, or a bleeder tap. Because of the high negative bias, only the positive half-cycles of the rf signal are amplified by the tube. The

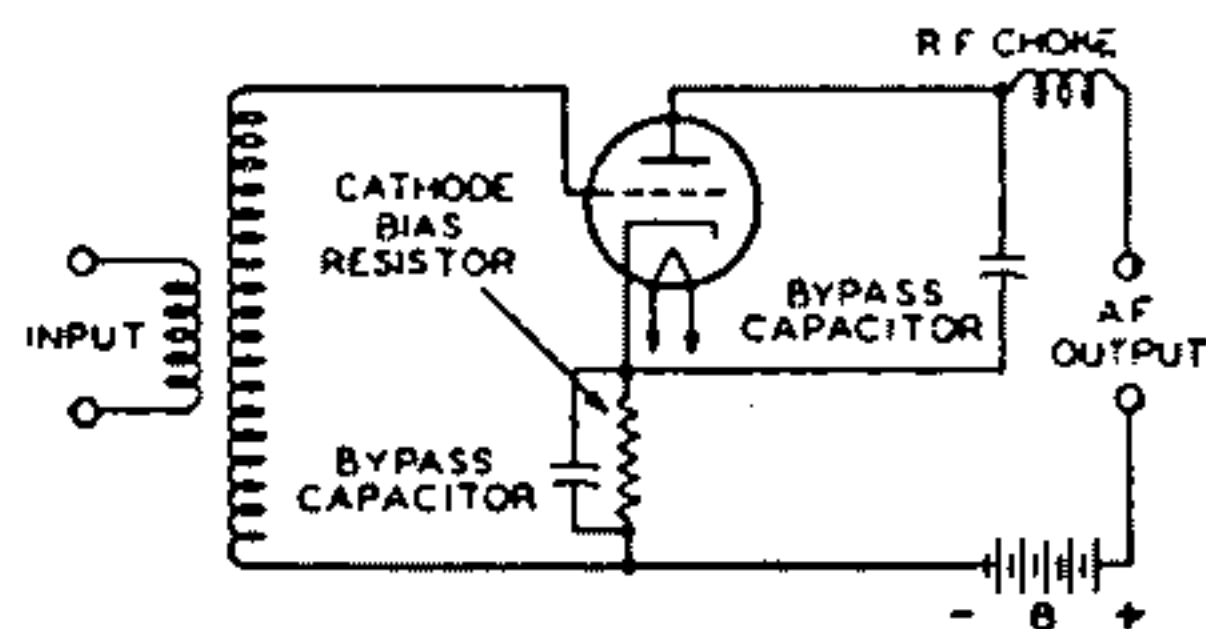


Fig. 26—Grid-bias detector circuit.



signal is, therefore, detected in the plate circuit. The advantages of this method of detection are that it amplifies the signal, besides detecting it, and that it does not draw current from the input circuit and therefore does not reduce the selectivity of the input circuit.

The **grid-resistor-and-capacitor method**, illustrated in Fig. 27, is somewhat more sensitive than the grid-bias method and gives its best results on weak signals. In this circuit, there is no negative dc bias voltage applied to the grid. Hence, on the positive half-cycles of the rf signal, current flows from grid to cathode. The grid and cathode thus act as a diode detector, with the grid resistor as the diode load resistor and the grid capacitor as the rf bypass capacitor. The voltage across the capacitor then reproduces the af modulation in the same manner as has been explained for the diode detector. This voltage appears between the grid and cathode and is therefore amplified in

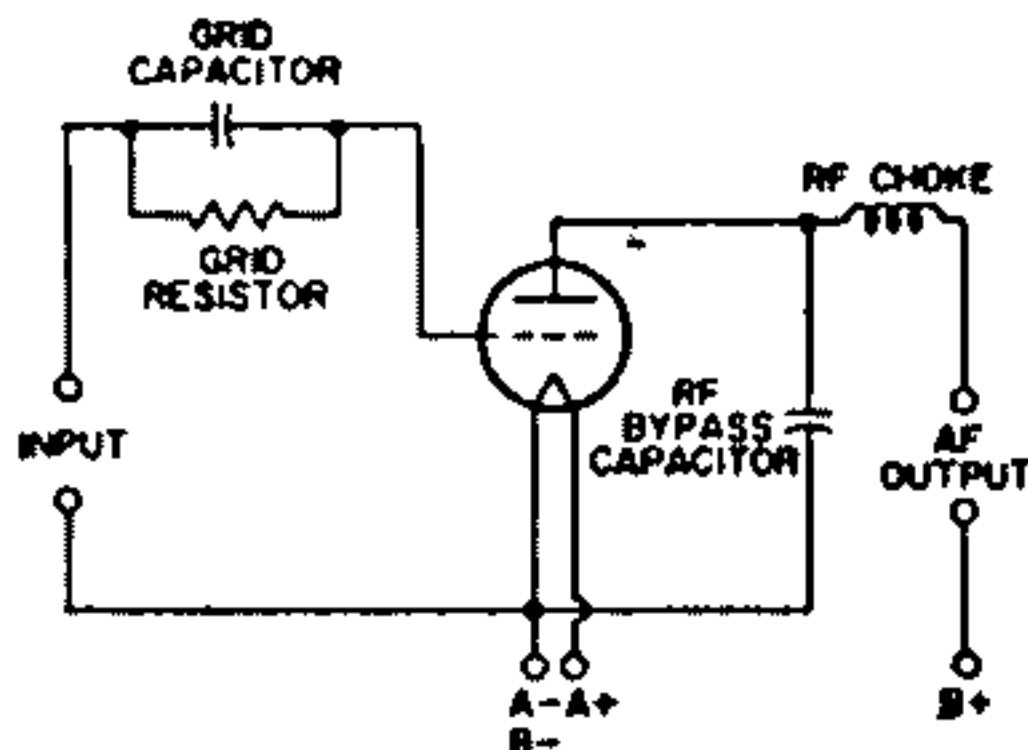


Fig. 27—Detector circuit using grid-resistor-and-capacitor bias.

the plate circuit. The output voltage thus reproduces the original af signal.

In this detector circuit, the use of a high-resistance grid resistor increases selectivity and sensitivity. However, improved af response and stability are obtained with lower values of grid-circuit resistance. This detector circuit amplifies the signal, but draws current from the input circuit and therefore reduces the selectivity of the input circuit.

### FM Detection

The effect of **frequency modulation** on the waveform of the rf wave is shown in Fig. 28. In this type of transmission, the frequency of the rf wave deviates from a mean value, at an rf

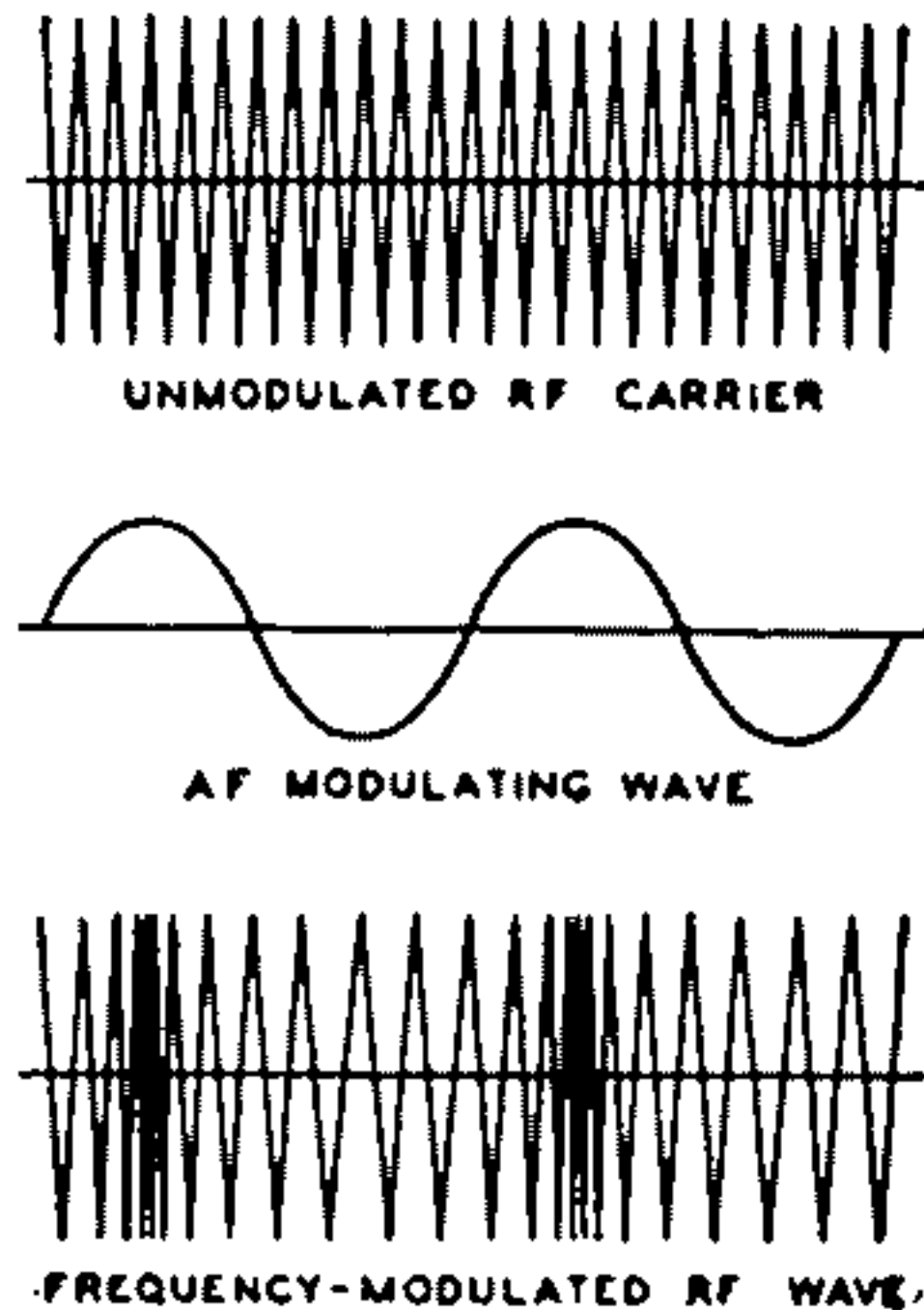


Fig. 28—Waveforms showing effect of frequency modulation on an rf wave.

rate depending on the modulation, by an amount that is determined in the transmitter and is proportional to the amplitude of the af modulation signal.

For this type of modulation, a detector is required to discriminate between deviations above and below the mean frequency and to translate those deviations into a voltage whose amplitude varies at audio frequencies. Since the deviations occur at an audio frequency, the process is one of demodulation, and the degree of frequency deviation determines the amplitude of the demodulated (af) voltage.

A simple circuit for converting frequency variations to amplitude variations is a circuit which is tuned so that the mean radio frequency is on one slope of its resonance characteristic, as at A of Fig. 29. With modulation, the

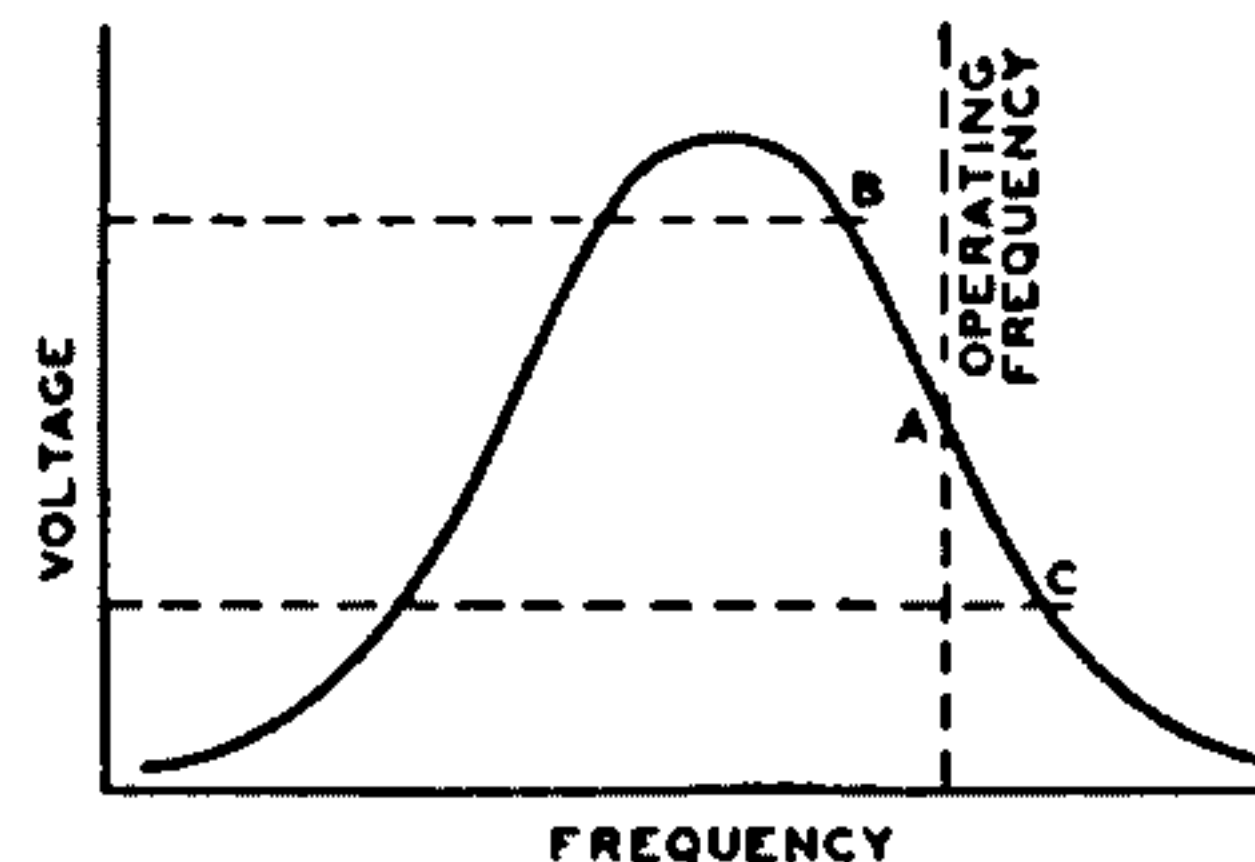


Fig. 29—Resonance curve showing desired operating range for frequency-modulation converter.

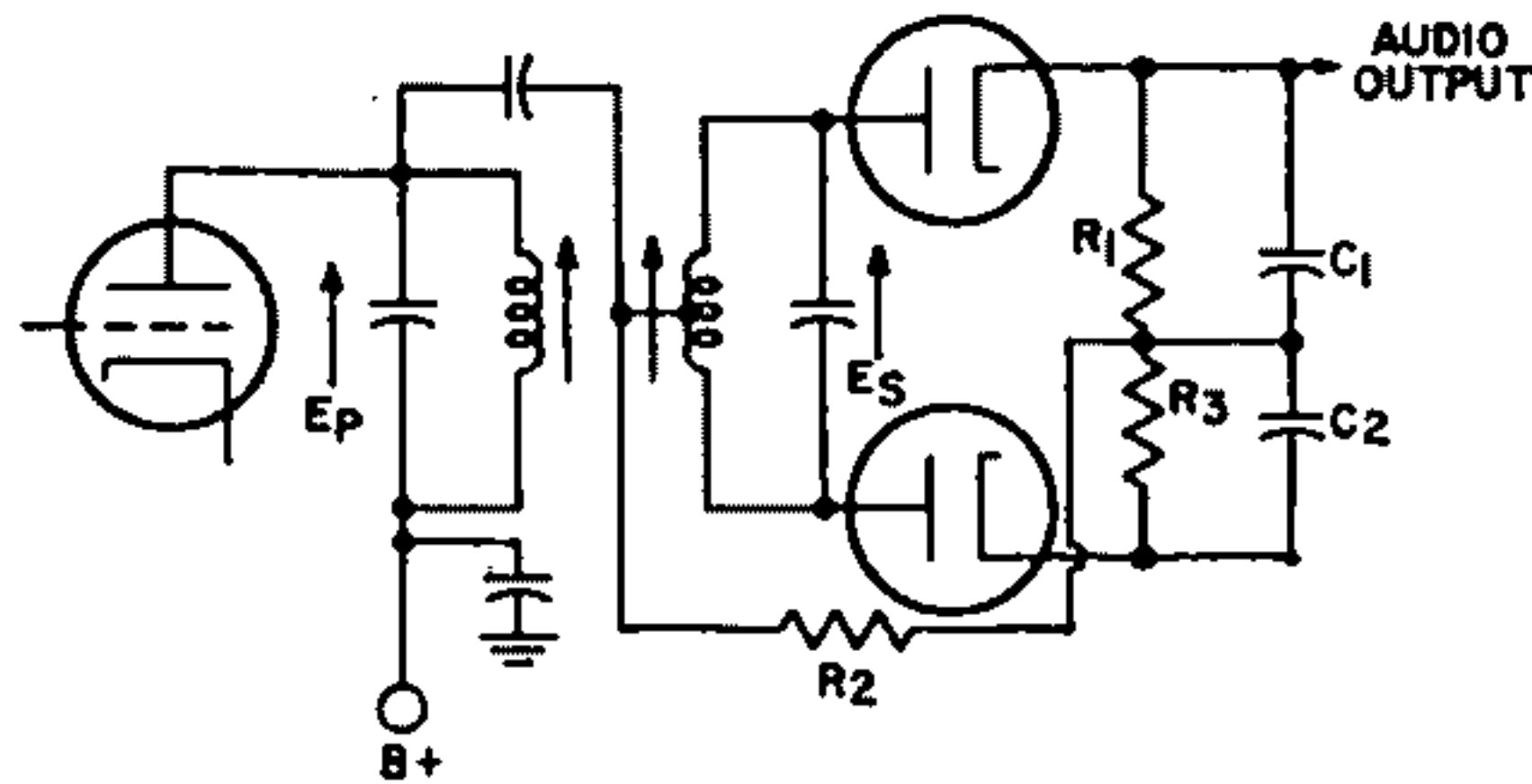


Fig. 30—Balanced phase-shift discriminator circuit.

frequency swings between B and C, and the voltage developed across the circuit varies at the modulating rate. In order that no distortion will be introduced in this circuit, the frequency swing must be restricted to the portion of the slope which is effectively straight. Since this portion is very short, the voltage developed is low. Because of these limitations, this circuit is not commonly used but it serves to illustrate the principle.

The faults of the simple circuit are overcome in a push-pull arrangement, such as that shown in Fig. 30, called a **balanced phase-shift discriminator**. In this detector, the mutually coupled tuned circuits in the primary and secondary windings of the transformer T are tuned to the center frequency. A characteristic of a double-tuned transformer is that the voltages in the primary and secondary windings are 90 degrees out of phase at resonance, and that the phase shift changes as the frequency changes from resonance. Therefore, the signal applied to the diodes and the RC combinations for peak detection also changes with frequency.

Because the secondary winding of the transformer T is center-tapped, the applied primary voltage  $E_p$  is added to one-half the secondary voltage  $E_s$  through the capacitor  $C_1$ . The addition of these voltages at resonance can be represented by the diagram in Fig. 31(a); the resultant voltage  $E_1$  is the signal applied to one peak-detector network consisting of one diode and its RC load. When the signal frequency decreases (from resonance), the phase shift of  $E_s/2$  becomes greater than 90 degrees, as shown at (b) in Fig. 31, and  $E_1$  becomes smaller. When the signal fre-

quency increases (above resonance), the phase shift of  $E_s/2$  is less than 90 degrees as shown at (c), and  $E_1$  becomes

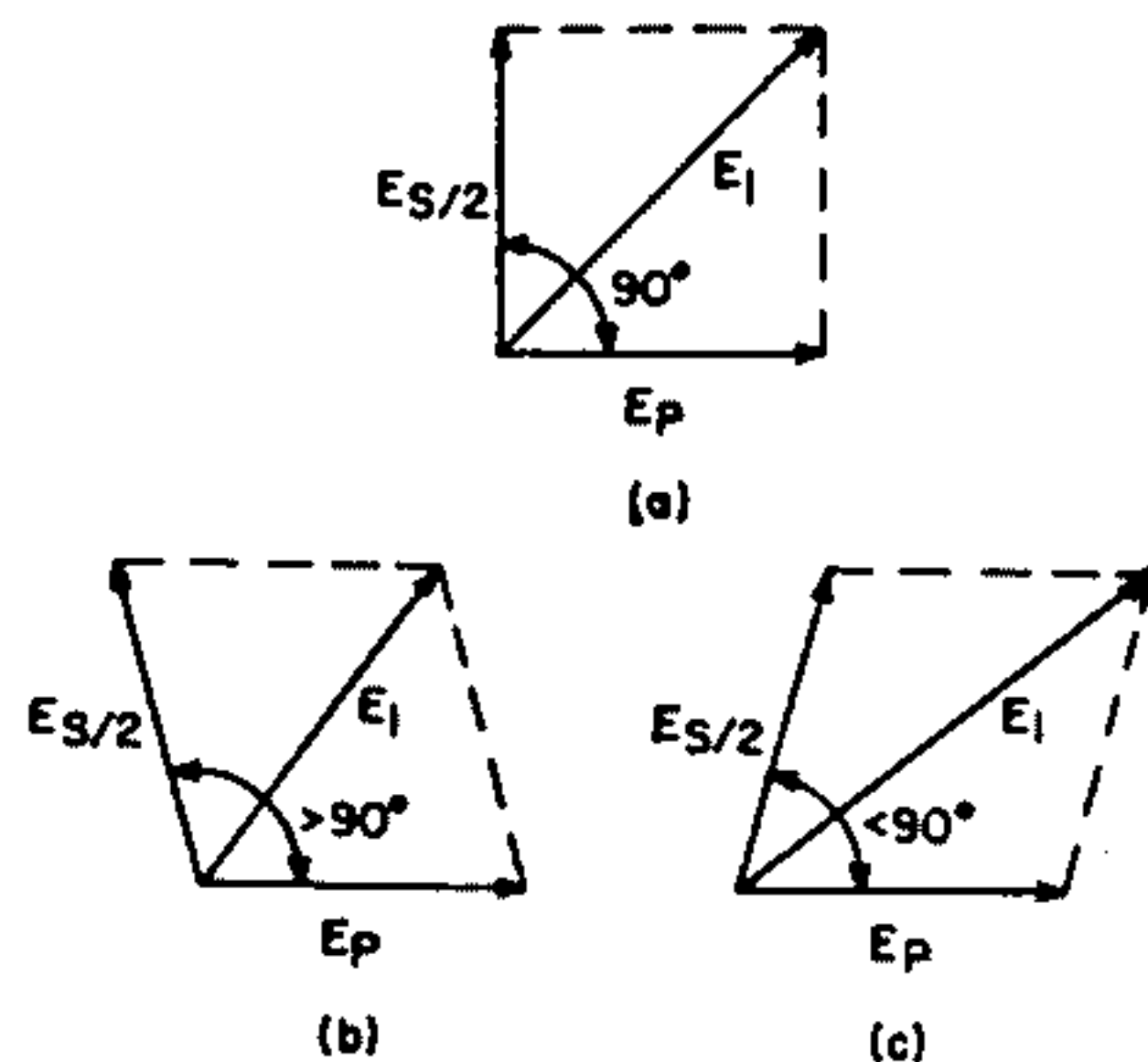


Fig. 31—Diagram illustrating phase shift in double-tuned transformer (a) at resonance, (b) below resonance, and (c) above resonance.

larger. The curve of  $E_1$  as a function of frequency in Fig. 32 is readily identified as the response curve of an FM detector.

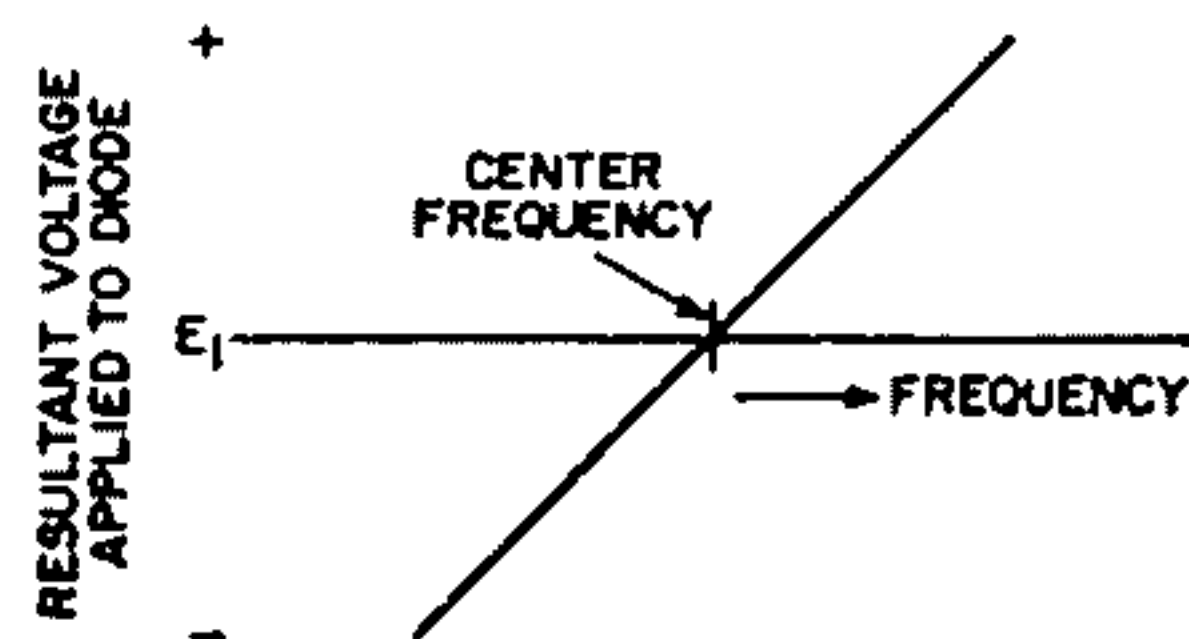


Fig. 33—Diagram showing resultant voltage  $E_1$  in Fig. 31 as a function of frequency.

Because the discriminator circuit shown in Fig. 30 uses a push-pull configuration, the diodes conduct on alternate half-cycles of the signal frequency and produce a plus-and-minus output with respect to zero rather than with



respect to  $E_1$ . The primary advantage of this arrangement is that there is no output at resonance. When an FM signal is applied to the input, the audio output voltage varies above and below zero as the instantaneous frequency varies above and below resonance. The frequency of this audio voltage is determined by the modulation frequency of the FM signal, and the amplitude of the voltage is proportional to the frequency excursion from resonance. (The resistor  $R_2$  in the circuit provides a dc return for the diodes, and also maintains a load impedance across the primary winding of the transformer.)

One disadvantage of the balanced phase-shift discriminator shown in Fig. 30 is that it detects audio modulation (AM) as well as frequency modulation (FM) in the if signal because the circuit is balanced only at the center frequency. At frequencies off resonance, any variation in amplitude of the if signal is reproduced to some extent in the audio output.

The ratio-detector circuit shown in Fig. 33 is a discriminator circuit which has the advantage of being relatively

placed "back-to-back" (in series, rather than in push-pull) so that both halves of the circuit operate simultaneously during one-half of the signal frequency cycle (and are cut off on the other half-cycle). As a result, the detected voltages  $E_1$  and  $E_2$  are in series, as shown for the instantaneous polarities that occur during the conduction half-cycle. When the audio output is taken between the equal capacitors  $C_1$  and  $C_2$ , therefore, the output voltage is equal to  $(E_2 - E_1)/2$  (for equal resistors  $R_1$  and  $R_2$ ).

The dc circuit of the ratio detector consists of a path through the secondary winding of the transformer, both diodes (which are in series), and resistors  $R_1$  and  $R_2$ . The value of the electrolytic capacitor  $C_3$  is selected so that the time constant of  $R_1$ ,  $R_2$ , and  $C_3$  is very long compared to the detected audio signal. As a result, the sum of the detected voltages ( $E_1 + E_2$ ) is a constant and the AM components on the signal frequency are suppressed. This feature of the ratio detector provides improved AM rejection as compared to the phase-shift discriminator circuit shown in Fig. 30.

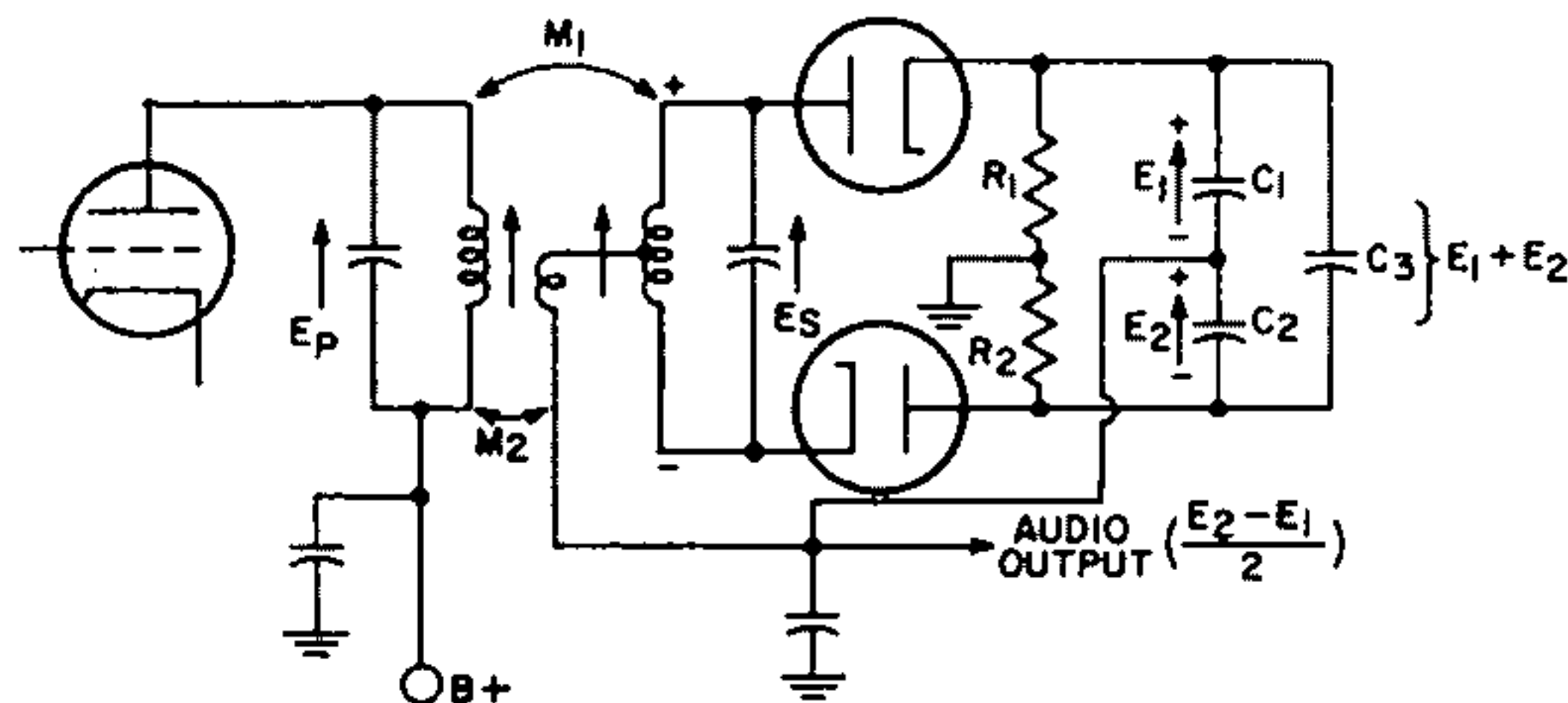


Fig. 33—Radio-detector circuit.

insensitive to amplitude variations in the FM signal. In this circuit,  $E_p$  is added to  $E_s/2$  through the mutual coupling  $M_2$  (this voltage addition may be made by either mutual or capacitive coupling). Because of the phase-shift relationship of these voltages, the resultant detected signals vary with frequency variations in the same manner as described for the phase-shift discriminator circuit shown in Fig. 30. However, the diodes in the ratio detector are

### Amplification

The amplifying action of an electron tube was mentioned under **Triodes** in the section on **Electrons, Electrodes, and Electron Tubes**. This action can be utilized in electronic circuits in a number of ways, depending upon the results desired. Four classes of amplifier service recognized by engineers are covered by definitions standardized by the Institute of Radio Engineers

(now the Institute of Electrical and Electronics Engineers). This classification depends primarily on the fraction of input cycle during which plate current is expected to flow under rated full-load conditions. The classes are class A, class AB, class B, and class C. The term "cutoff bias" used in these definitions is the value of grid bias at which plate current is very small.

### Classes of Service

A **class A amplifier** is an amplifier in which the grid bias and alternating grid voltages are such that plate current in a specific tube flows at all times.

A **class AB amplifier** is an amplifier in which the grid bias and alternating grid voltages are such that plate current in a specific tube flows for appreciably more than half but less than the entire electrical cycle.

A **class B amplifier** is an amplifier in which the grid bias is approximately equal to the cutoff value, so that the plate current is approximately zero when no exciting grid voltage is applied, and so that plate current in a specific tube flows for approximately one-half of each cycle when an alternating grid voltage is applied.

A **class C amplifier** is an amplifier in which the grid bias is appreciably greater than the cutoff value, so that the plate current in each tube is zero when no alternating grid voltage is applied, and so that plate current flows in a specific tube for appreciably less than one-half of each cycle when an alternating grid voltage is applied.

The suffix 1 may be added to the letter or letters of the class identification to denote that grid current does not flow during any part of the input cycle. The suffix 2 may be used to denote that grid current flows during part of the cycle.

For radio-frequency (rf) amplifiers which operate into a selective tuned circuit, as in radio transmitter applications, or under requirements where distortion is not an important factor, any of the above classes of amplifiers may be used, either with a single tube or with a push-pull stage. For audio-frequency (af) amplifiers in which dis-

tortion is an important factor, only class A amplifiers permit single-tube operation. In this case, operating conditions are usually chosen so that distortion is kept below the conventional 5 per cent for triodes and the conventional 7 to 10 per cent for tetrodes or pentodes. Distortion can be reduced below these figures by means of special circuit arrangements such as that discussed under **inverse feedback**. With class A amplifiers, reduced distortion with improved power performance can be obtained by using a push-pull stage for audio service. With class AB and class B amplifiers, a balanced stage using two tubes is required for audio service.

### Class A Voltage Amplifiers

As a class A voltage amplifier, an electron tube is used to reproduce grid-voltage variations across an impedance or a resistance in the plate circuit. These variations are essentially of the same form as the input signal voltage impressed on the grid, but their amplitude is increased. This increase is accomplished by operation of the tube at a suitable grid bias so that the applied grid input voltage produces plate-current variations proportional to the signal swings. Because the voltage variation obtained in the plate circuit is much larger than that required to swing the grid, amplification of the signal is obtained.

Fig. 34 gives a graphical illustration of this method of amplification and shows, by means of the grid-voltage vs. plate-current characteristics curve, the effect of an input signal (S) applied to the grid of a tube. The output signal (O)

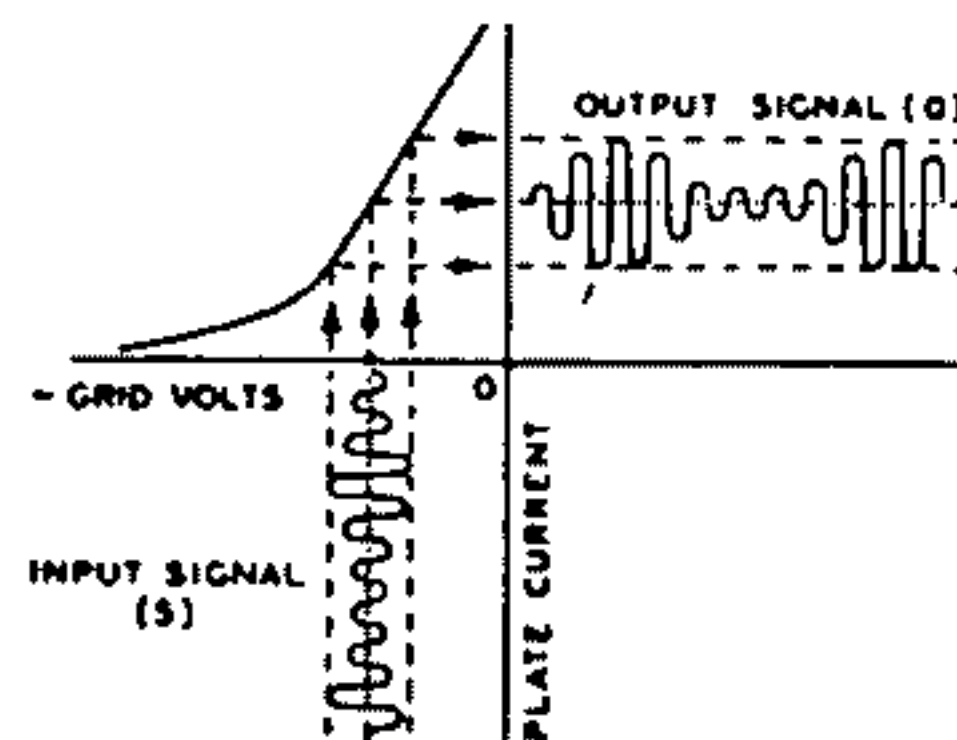


Fig. 34—Current characteristics of class A amplifier.



is the resulting amplified plate-current variation.

The plate current flowing through the load resistance ( $R$ ) of Fig. 35 causes a voltage drop which varies directly with the plate current. The ratio of this voltage variation produced in the load resistance to the input signal volt-

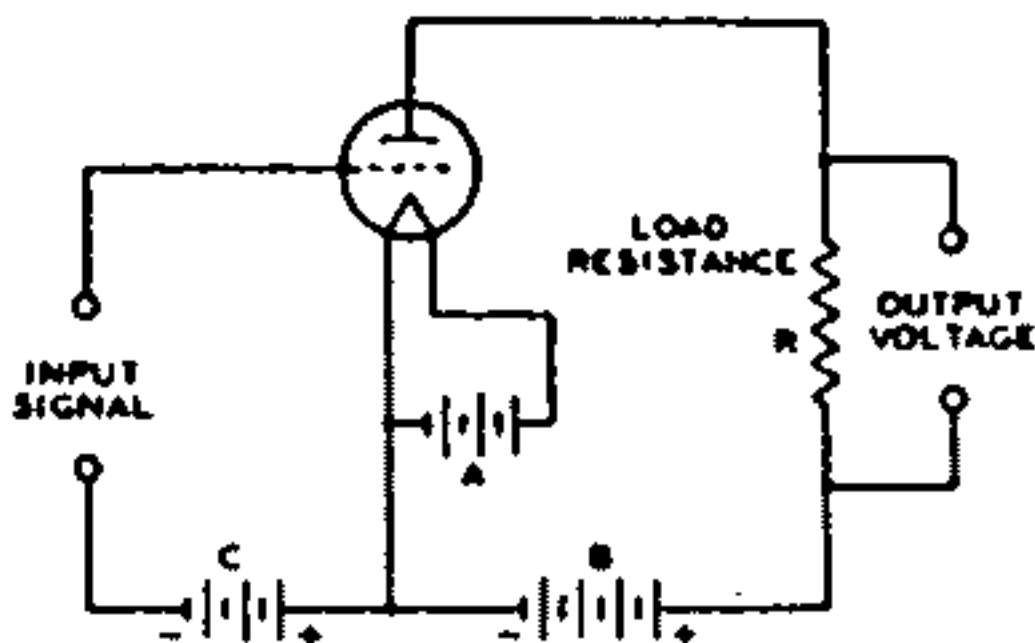


Fig. 35—Triode amplifier circuit.

age is the voltage amplification, or gain, provided by the tube. The voltage amplification due to the tube is expressed by the following convenient formulas:

$$\text{Voltage amplification} = \frac{\mu \times R_L}{R_L + r_p}$$

$$\text{or } \frac{g_m \times r_p \times R_L}{1000000 \times (r_p + R_L)}$$

where  $\mu$  is the amplification factor of the tube,  $R_L$  is the load resistance in ohms,  $r_p$  is the plate resistance in ohms, and  $g_m$  is the transconductance in micromhos.

From the first formula, it can be seen that the gain actually obtainable from the tube is less than the tube amplification factor, but that the gain approaches the amplification factor when the load resistance is large compared to the tube plate resistance. Fig. 36 shows graphically how the gain approaches the amplification factor of the tube as the load resistance is increased.

From the curve it can be seen that a high value of load resistance should be used to obtain high gain in a voltage amplifier.

In a **resistance-coupled amplifier**, the load resistance of the tube is approximately equal to the resistance of the plate resistor in parallel with the grid resistor of the following stage. Hence, to obtain a large value of load resistance, it is necessary to use a plate resistor and a grid resistor of large resistance. However, the plate resistor should not be too large because the flow of plate current through the plate resistor produces a voltage drop which reduces the plate voltage applied to the tube. If the plate resistor is too large, this drop will be too large, the plate voltage on the tube will be too small, and the voltage output of the tube will be too small. Also, the grid resistor of the following stage should not be too large, the actual maximum value being dependent on the particular tube type. This precaution is necessary because all tubes contain minute amounts of residual gas which cause a minute flow of current through the grid resistor. If the grid resistor is too large, the positive bias developed by the flow of this current through the resistor decreases the normal negative bias and produces an increase in the plate current. This increased current may overheat the tube and cause liberation of more gas which, in turn, will cause further decrease in bias. The action is cumulative and results in a runaway condition which can destroy the tube.

A higher value of grid resistance is permissible when cathode-resistor bias is used than when fixed bias is used.

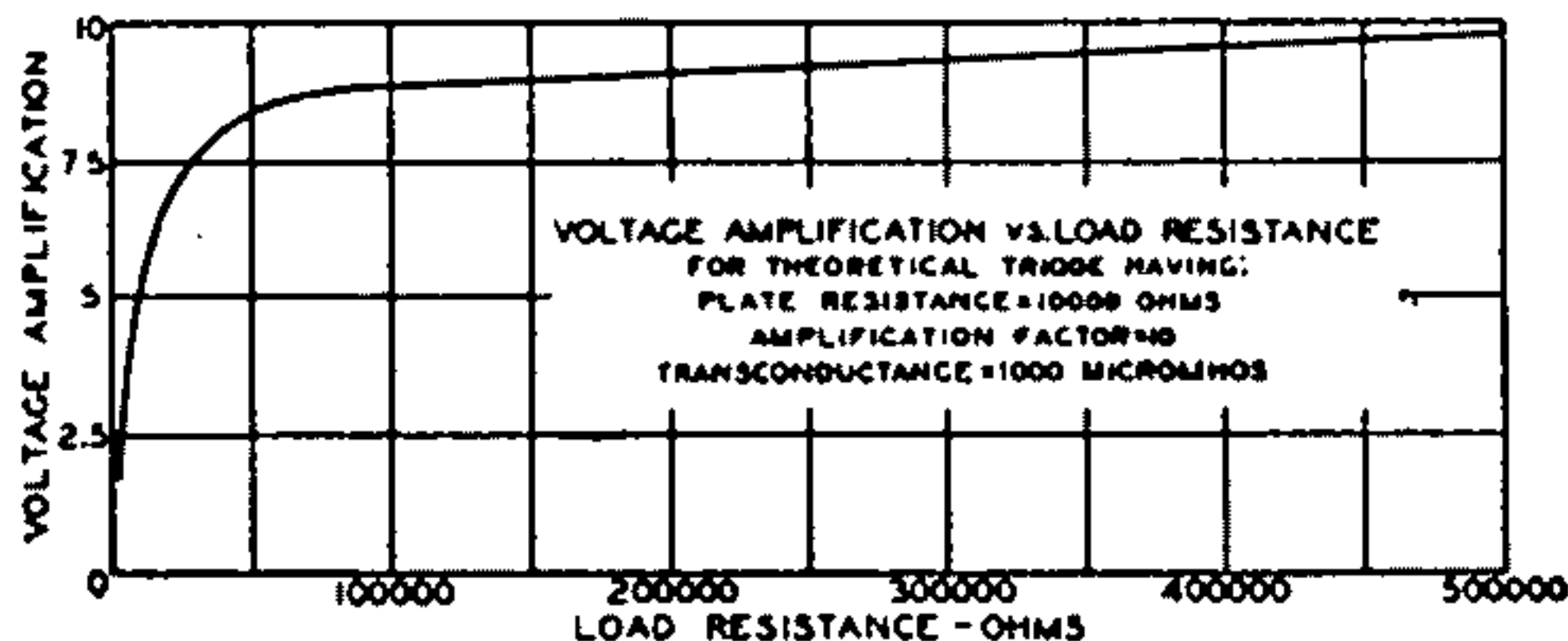


Fig. 36—Gain curve for triode amplifier circuit.

When cathode-resistor bias is used, a loss in bias due to gas or grid-emission effects is almost completely offset by an increase in bias due to the voltage drop across the cathode resistor. Typical values of plate resistor and grid resistor for tube types used in resistance-coupled circuits, and the values of gain obtainable, are shown in the **Resistance-Coupled Amplifier** section.

The **input impedance** of an electron tube (that is, the impedance between grid and cathode) consists of (1) a reactive component due to the capacitance between grid and cathode, (2) a resistive component resulting from the time of transit of electrons between cathode and grid, and (3) a resistive component developed by the part of the cathode lead inductance which is common to both the input and output circuits. Components (2) and (3) are dependent on the frequency of the incoming signal. The input impedance is very high at audio frequencies when a tube is operated with its grid biased negative. In a class  $A_1$  or  $AB_1$  transformer-coupled audio amplifier, therefore, the loading imposed by the grid on the input transformer is negligible. As a result, the secondary impedance of a class  $A_1$  or class  $AB_1$  input transformer can be made very high because the choice is not limited by the input impedance of the tube; however, transformer design considerations may limit the choice.

At the higher radio frequencies, the input impedance may become very low even when the grid is negative, due to the finite time of passage of electrons between cathode and grid and to the appreciable lead reactance. This impedance drops very rapidly as the frequency is raised, and increases input-circuit loading. In fact, the input impedance may become low enough at very high radio frequencies to affect the gain and selectivity of a preceding stage appreciably. Tubes such as the "acorn" and "pencil" types and the high-frequency miniatures have been developed to have low input capacitances, low electron-transit time, and low lead inductance so that their input impedance is high even at the ultra-

high radio frequencies. **Input admittance** is the reciprocal of input impedance.

A **remote-cutoff amplifier tube** is a modified construction of a pentode or a tetrode type designed to reduce modulation-distortion and cross-modulation in radio-frequency stages. **Cross-modulation** is the effect produced in a radio or television receiver by an interfering station "riding through" on the carrier of the station to which the receiver is tuned. **Modulation-distortion** is a distortion of the modulated carrier and appears as audio-frequency distortion in the output. This effect is produced by a radio-frequency amplifier stage operating on an excessively curved characteristic when the grid bias has been increased to reduce volume. The offending stage for cross-modulation is usually the first radio-frequency amplifier, while for modulation-distortion the cause is usually the last intermediate-frequency stage. The characteristics of remote-cutoff types are such as to enable them to handle both large and small input signals with minimum distortion over a wide range of signal strength.

Fig. 37 illustrates the construction of the grid No. 1 (control grid) in a remote-cutoff tube. The remote-cutoff

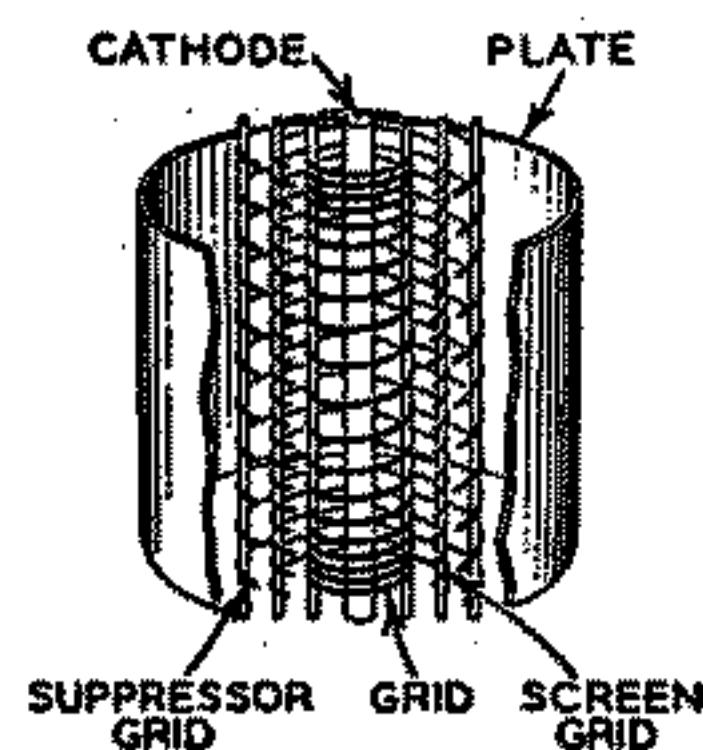


Fig. 37—Structure of remote-cutoff grid.

action is due to the structure of the grid which provides a variation in amplification factor with change in grid bias. The grid No. 1 is wound with open spacing at the middle and with close spacing at the ends. When weak signals and low grid bias are applied to the tube, the effect of the non-uniform turn spacing of the grid on cathode emission and tube characteristics is essentially the same as for uniform spacing. As the



grid bias is made more negative to handle larger input signals, the electron flow from the sections of the cathode enclosed by the ends of the grid is cut off. The plate current and other tube characteristics are then dependent on the electron flow through the open section of the grid. This action changes the gain of the tube so that large signals may be handled with minimum distortion due to cross-modulation and modulation-distortion.

Fig. 38 shows a typical plate-current vs. grid-voltage curve for a remote-cutoff type compared with the curve

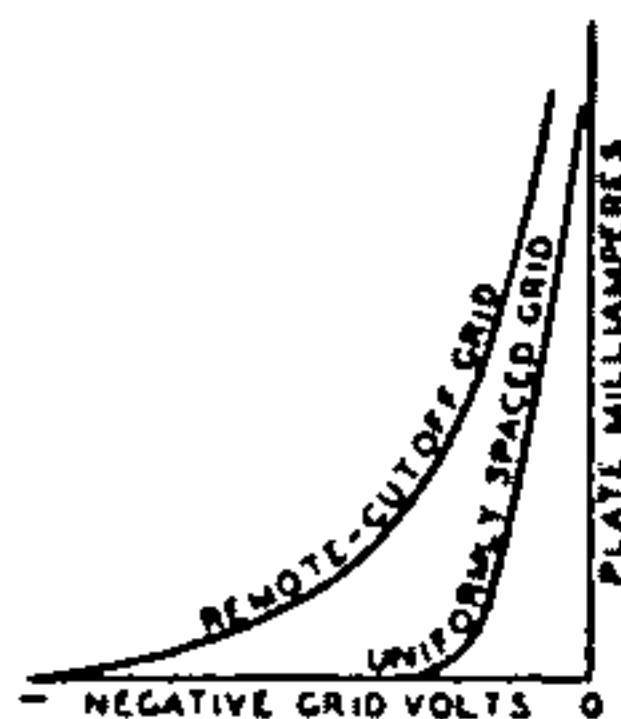


Fig. 38—Plate-current curves for triodes having remote-cutoff and uniformly spaced grids.

for a type having a uniformly spaced grid. It will be noted that while the curves are similar at small grid-bias voltages, the plate current of the remote-cutoff tube drops quite slowly with large values of bias voltage. This slow change makes it possible for the tube to handle large signals satisfactorily. Because remote-cutoff types can accommodate large and small signals, they are particularly suitable for use in sets having automatic volume control. Remote-cutoff tubes also are known as *variable-mu* types.

### Class A Power Amplifiers

As a class A power amplifier, an electron tube is used in the output stage of a radio or television receiver to supply a relatively large amount of power to the loudspeaker. For this application, large power output is of more importance than high voltage amplification; therefore, gain possibilities are sacrificed in the design of power tubes to obtain power-handling capability.

Triodes, pentodes, and beam power

tubes designed for power amplifier service have certain inherent features for each structure. Power tubes of the triode type for class A service are characterized by low power sensitivity, low plate-power efficiency, and low distortion. Power tubes of the pentode type are characterized by high power sensitivity, high plate-power efficiency and, usually, somewhat higher distortion than class A triodes. Beam power tubes have higher power sensitivity and efficiency than triode or conventional pentode types.

A class A power amplifier is also used as a driver to supply power to a class AB<sub>2</sub> or a class B stage. It is usually advisable to use a triode, rather than a pentode, in a driver stage because of the lower plate impedance of the triode.

Power tubes connected in either parallel or push-pull may be employed as class A amplifiers to obtain increased output. The parallel connection (Fig. 39) provides twice the output of a single tube with the same value of grid-signal voltage. With this connection, the effective transconductance of the stage is doubled, and the effective plate

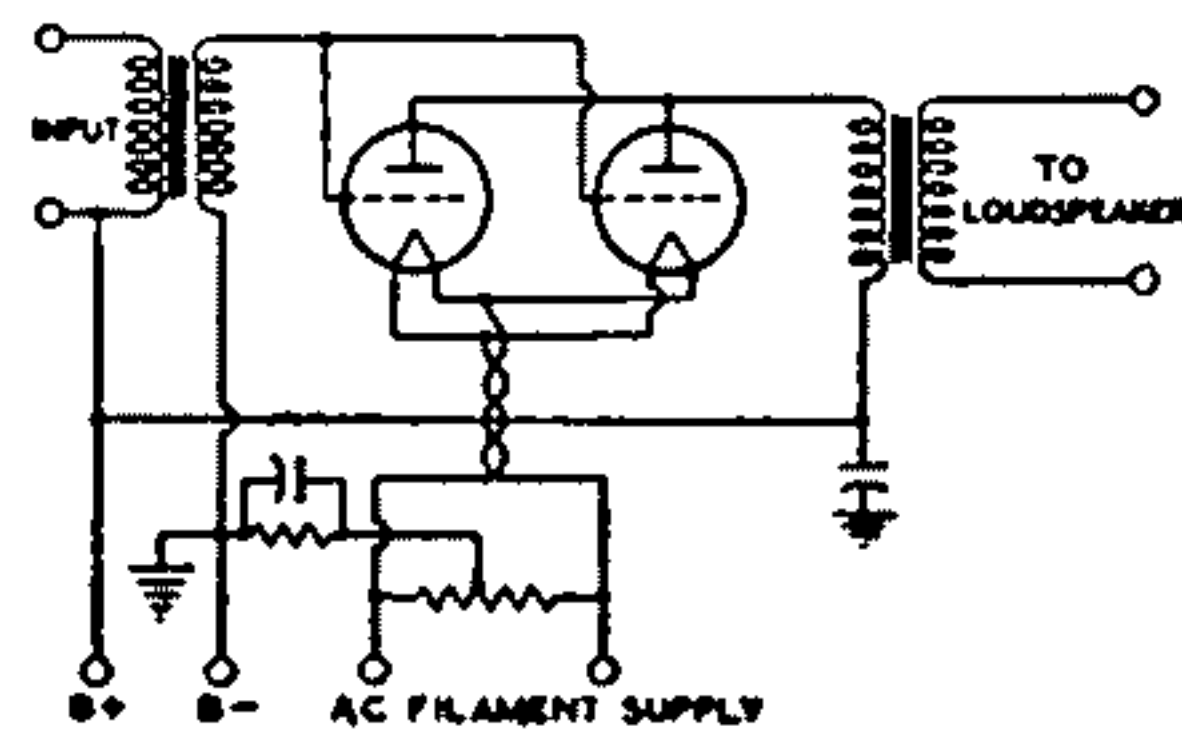


Fig. 39—Power amplifier with tubes connected in parallel.

resistance and the load resistance required are halved as compared with single-tube values.

The push-pull connection (Fig. 40), although it requires twice the grid-signal voltage, provides increased power and has other important advantages over single-tube operation. Distortion caused by even-order harmonics and hum caused by plate-voltage-supply fluctuations are either eliminated or decidedly reduced through cancellation.

Because distortion for push-pull operation is less than for single-tube operation, appreciably more than twice single-tube output can be obtained with triodes by decreasing the load resistance for the stage to a value approaching the load resistance for a single tube.

For either parallel or push-pull class A operation of two tubes, all electrode currents are doubled while all dc electrode voltages remain the same as for single-tube operation. If a cathode resistor is used, its value should be about one-half that for a single tube.

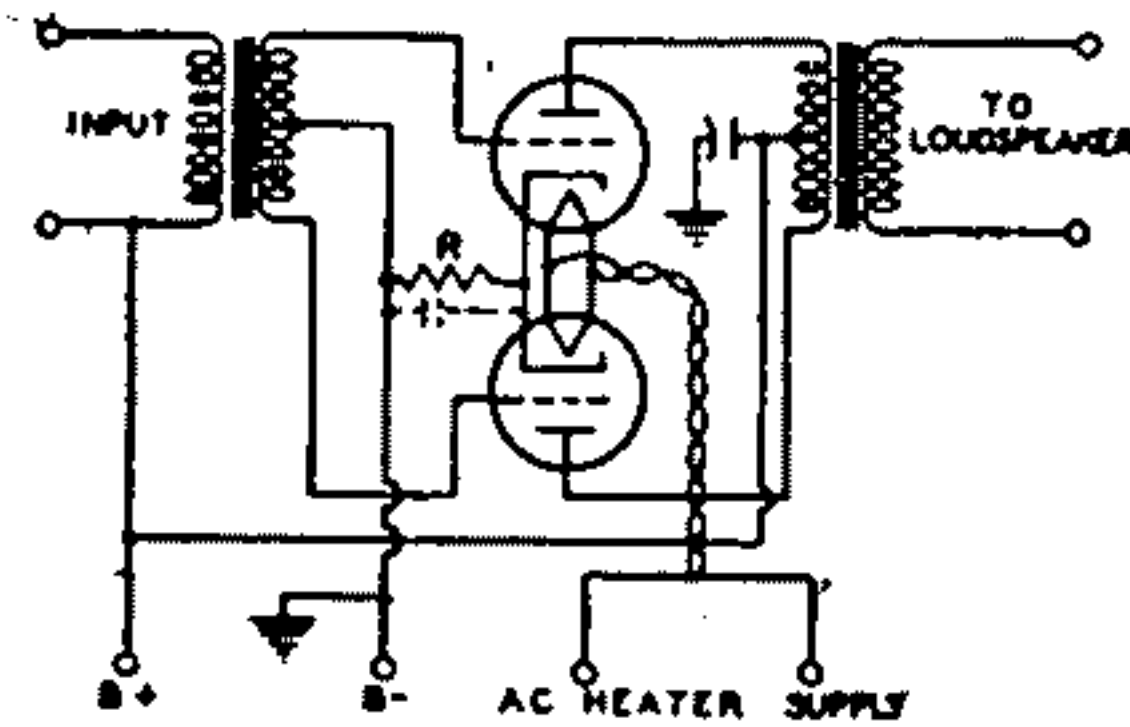


Fig. 40—Power amplifier with tubes connected in push-pull.

If oscillations occur with either type of connection, they can often be eliminated by the use of a non-inductive resistor of approximately 100 ohms connected in series with each grid at the socket terminal.

Operation of power tubes so that the grids run positive is inadvisable except under conditions such as those discussed in this section for class AB and class B amplifiers.

**Power-Output Calculations**

Calculation of the power output of a triode used as a class A amplifier with either an output transformer or a choke having low dc resistance can be made

without serious error from the plate family of curves by assuming a resistance load. The proper plate current, grid bias, optimum load resistance, and per-cent second-harmonic distortion can also be determined. The calculations are made graphically and are illustrated in Fig. 41 for given conditions. The procedure is as follows:

- (1) Locate the zero-signal bias point P by determining the zero-signal bias  $E_c$  from the formula:

$$\text{Zero-signal bias } (E_{c0}) = -(0.68 \times E_b) / \mu$$

where  $E_b$  is the chosen value in volts of dc plate voltage at which the tube is to be operated, and  $\mu$  is the amplification factor of the tube. This quantity is shown as negative to indicate that a negative bias is used.

- (2) Locate the value of zero-signal plate current,  $I_0$ , corresponding to point P.

- (3) Locate the point  $2I_0$ , which is twice the value of  $I_0$  and corresponds to the value of the maximum-signal plate current  $I_{max}$ .

- (4) Locate the point X on the dc bias curve at zero volts,  $E_c = 0$ , corresponding to the value of  $I_{max}$ .

- (5) Draw a straight line XY through X and P.

Line XY is known as the load resistance line. Its slope corresponds to the value of the load resistance. The load resistance in ohms is equal to  $(E_{max} - E_{min})$  divided by  $(I_{max} - I_{min})$ , where E is in volts and I is in amperes.

It should be noted that in the case of filament types of tubes, the calculations are given on the basis of a dc-operated filament. When the filament is ac-operated, the calculated value of dc

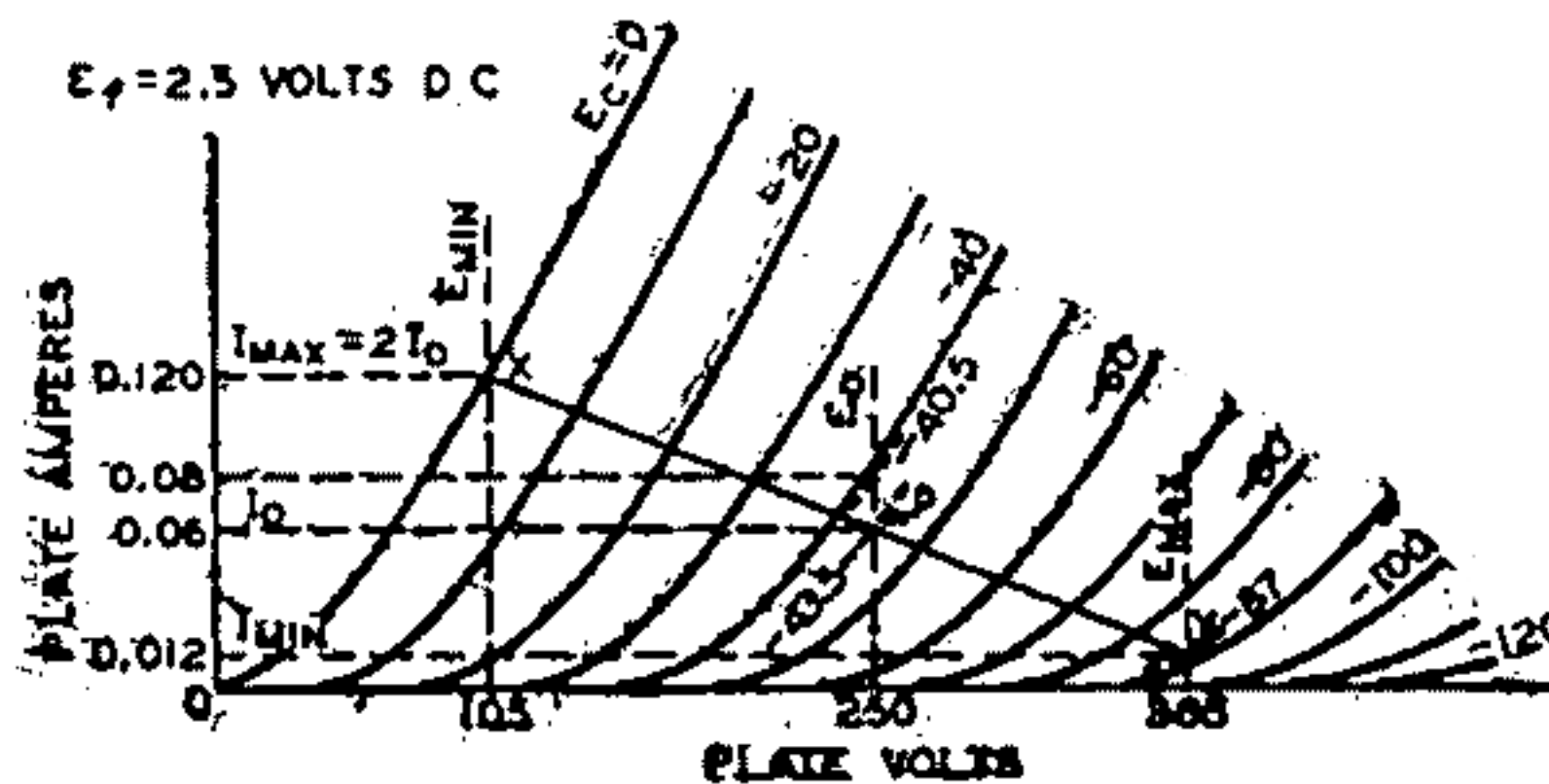


Fig. 41—Graphic calculations for class A amplifier using a power triode.



bias should be increased by approximately one-half the filament voltage rating of the tube.

The value of zero-signal plate current  $I_0$  should be used to determine the plate dissipation, an important factor influencing tube life. In a class A amplifier under zero-signal conditions, the plate dissipation is equal to the power input, *i.e.*, the product of the dc plate voltage  $E_0$  and the zero-signal dc plate current  $I_0$ . If it is found that the plate-dissipation rating of the tube is exceeded with the zero-signal bias  $E_0$  calculated above, it will be necessary to increase the bias by a sufficient amount so that the actual plate dissipation does not exceed the rating before proceeding further with the remaining calculations.

For power-output calculations, it is assumed that the peak alternating grid voltage is sufficient (1) to swing the grid from the zero-signal bias value  $E_0$  to zero bias ( $E_g = 0$ ) on the positive swing and (2) to swing the grid to a value twice the zero-signal bias value on the negative swing. During the negative swing, the plate voltage and plate current reach values of  $E_{max}$  and  $I_{min}$ ; during the positive swing, they reach values of  $E_{min}$  and  $I_{max}$ . Because power is the product of voltage and current, the power output  $P_0$  as shown by a watt-meter is given by

$$P_0 = \frac{(I_{max} - I_{min}) \times (E_{max} - E_{min})}{8}$$

where  $E$  is in volts,  $I$  is in amperes, and  $P_0$  is in watts.

In the output of power-amplifier triodes, some distortion is present. This distortion is due predominantly to second harmonics in single-tube amplifiers. The percentage of second-harmonic distortion may be calculated by the following formula:

$$\% \text{ distortion} = \frac{\frac{I_{max} + I_{min}}{2} - I_0}{I_{max} - I_{min}} \times 100$$

where  $I_0$  is the zero-signal plate current in amperes. If the distortion is excessive, the load resistance should be increased or, occasionally, decreased slightly and the calculations repeated.

**Example:** Determine the load resistance, power output, and distortion

of a triode having an amplification factor of 4.2, a plate-dissipation rating of 15 watts, and plate-characteristics curves as shown in Fig. 41. The tube is to be operated at 250 volts on the plate.

**Procedure:** For a first approximation, determine the operating point  $P$  from the zero-signal bias formula,  $E_0 = -(0.68 \times 250) / 4.2 = -40.5$  volts. From the curve for this voltage, it is found that the zero-signal plate current is 0.08 ampere and, therefore, the plate-dissipation rating is exceeded ( $0.08 \times 250 = 20$  watts). Consequently, it is necessary to reduce the zero-signal plate current to 0.06 ampere at 250 volts. The grid bias is then  $-43.5$  volts. Note that the curve was taken with a dc filament supply; if the filament is to be operated on an ac supply, the bias must be increased by about one-half the filament voltage, or to  $-45$  volts, and the circuit returns made to the mid-point of the filament circuit.

Point  $X$  can then be determined. Point  $X$  is at the intersection of the dc bias curve at zero volts with  $I_{max}$ , where  $I_{max} = 2I_0 = 2 \times 0.06 = 0.12$  ampere. Line  $XY$  is drawn through points  $P$  and  $X$ .  $E_{max}$ ,  $E_{min}$ , and  $I_{min}$  are then found from the curves. When these values are substituted in the power-output formula, the following result is obtained:

$$P_0 = \frac{(0.12 - 0.012) \times (365 - 105)}{8} = 3.52 \text{ watts}$$

The resistance represented by load line  $XY$  is

$$\frac{(365 - 105)}{(0.12 - 0.012)} = 2410 \text{ ohms}$$

When the values from the curves are substituted in the distortion formula, the following result is obtained:

$$\% \text{ distortion} = \frac{\frac{0.12 + 0.012}{2} - 0.06}{0.12 - 0.012} \times 100 = 5.5\%$$

It is customary to select the load resistance so that the distortion does not exceed five per cent. When the method shown is used to determine the slope of the load-resistance line, the second-harmonic distortion generally does not exceed five per cent. In the example, however, the distortion is excessive and it is desirable, therefore, to use a slightly higher load resistance. A load resistance

of 2500 ohms will provide a distortion of about 4.9 per cent. The power output is reduced only slightly to 3.5 watts.

Operating conditions for triodes in push-pull depend on the type of operation desired. Under class A conditions, distortion, power output, and efficiency are all relatively low. The operating bias can be anywhere between that specified for single-tube operation and that equal to one-half the grid-bias voltage required to produce plate-current cutoff at a plate voltage of  $1.4E_o$ , where  $E_o$  is the operating plate voltage. Higher bias than this value requires higher grid-signal voltage and results in class AB<sub>1</sub> operation, which is discussed later.

The method for calculating maximum power output for triodes in push-pull class A operation is as follows: Erect a vertical line at  $0.6 E_o$  (see Fig. 42), intersecting the  $E_c = 0$  curve at the point  $I_{max}$ . Then,  $I_{max}$  is determined from the curve for use in the formula

$$P_o = (I_{max} \times E_o) / 5$$

If  $I_{max}$  is expressed in amperes and  $E_o$  in volts, power output is in watts.

**Example:** Assume that the plate voltage ( $E_o$ ) is to be 300 volts, and the plate-dissipation rating of the tube is 15 watts. Then, for class A operation, the operating bias can be equal to, but not more than, one-half the grid bias for cutoff with a plate voltage of  $1.4 \times 300 = 420$  volts. (Since cutoff bias is approximately  $-115$  volts at a plate voltage of 420 volts, one-half of this value is  $-57.5$  volts bias.) At this bias, the plate current is found from the plate family to be 0.054 ampere and, therefore, the plate dissipation is  $0.054 \times 300$  or 16.2 watts. Since  $-57.5$  volts is the limit of bias for class A operation of these tubes at a plate voltage of 300 volts, the dissipation cannot be reduced by increasing the bias and it becomes necessary to reduce the plate voltage.

If the plate voltage is reduced to 250 volts, the bias will be found to be  $-43.5$  volts. For this value, the plate current is 0.06 ampere, and the plate dissipation is 15 watts. Then, following the method for calculating power output, erect a vertical line at  $0.6E_o = 150$

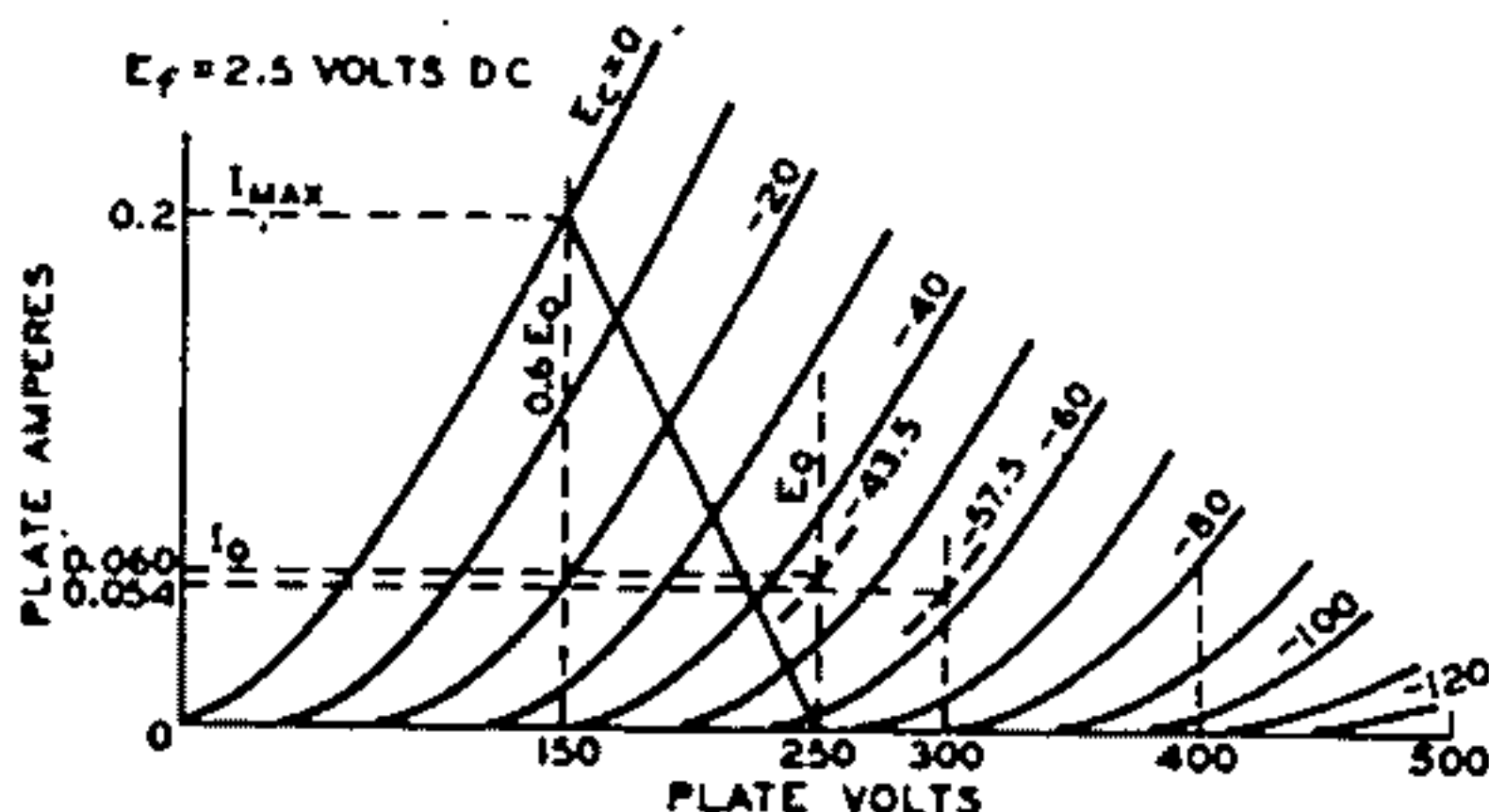


Fig. 42—Graphic calculations for push-pull class A amplifier using a power triode.

The method for determining the proper load resistance for triodes in push-pull is as follows: Draw a load line through  $I_{max}$  on the zero-bias curve and through the  $E_o$  point on the zero-current axis. Four times the resistance represented by this load line is the plate-to-plate load ( $R_{pp}$ ) for two triodes in a class A push-pull amplifier. Expressed as a formula,

$$R_{pp} = 4 \times (E_o - 0.6E_o) / I_{max}$$

where  $E_o$  is expressed in volts,  $I_{max}$  in amperes, and  $R_{pp}$  in ohms.

volts. The intersection of the line with the curve  $E_c = 0$  is  $I_{max}$  or 0.2 ampere. When this value is substituted in the power formula, the power output is  $(0.2 \times 250) / 5 = 10$  watts. The load resistance is determined from the load formula: Plate-to-plate load ( $R_{pp}$ ) =  $4 \times (250 - 150) / 0.2 = 2000$  ohms.

Power output for a pentode or a beam power tube as a class A amplifier can be calculated in much the same way as for triodes. Calculations can be made graphically from a special plate family of curves, as shown in Fig. 43.



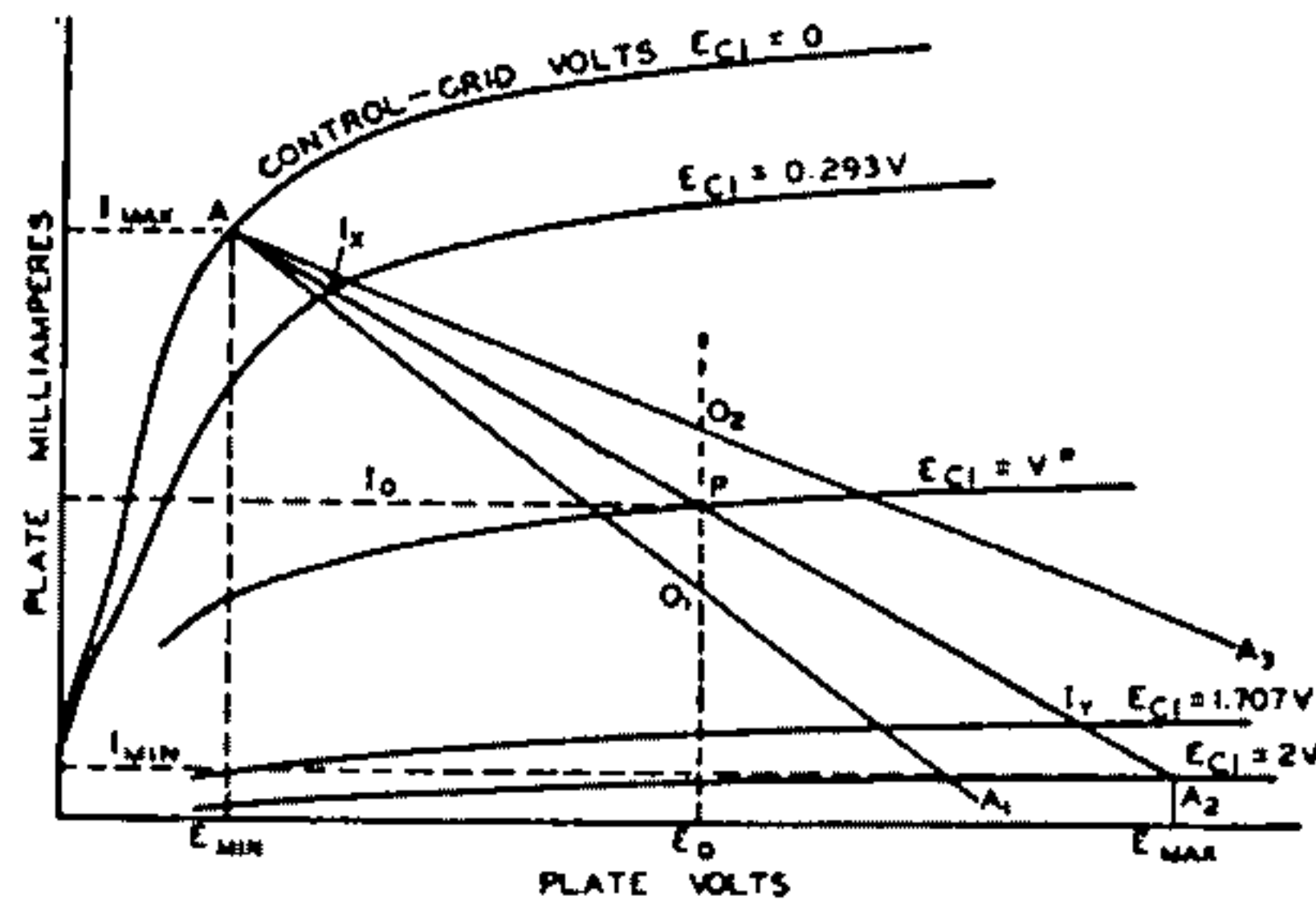


Fig. 43—Graphic calculations for class A amplifier using a pentode or beam power tube.

From a point A at or just below the knee of the zero-bias curve, draw arbitrarily selected load lines to intersect the zero-plate-current axis. These lines should be on both sides of the operating point P, whose position is determined by the desired operating plate voltage,  $E_0$ , and one-half the maximum-signal plate current. Along any load line, say  $AA_1$ , measure the distance  $AO_1$ . On the same line, lay off an equal distance,  $O_1A_1$ . For optimum operation, the change in bias from A to  $O_1$  should be nearly equal to the change in bias from  $O_1$  to  $A_1$ . If this condition can not be met with one line, as is the case for the line first chosen, then another should be chosen. When the most satisfactory line has been selected, its resistance may be determined by the following formula:

$$\text{Load resistance } (R_L) = \frac{E_{\max} - E_{\min}}{I_{\max} - I_{\min}}$$

The value of  $R_L$  may then be substituted in the following formula for calculating power output.

$$P_o = \frac{[I_{\max} - I_{\min} + 1.41(I_x - I_y)]^2 R_L}{32}$$

In both of these formulas,  $I$  is in amperes,  $E$  is in volts,  $R_L$  is in ohms, and  $P_o$  is in watts.  $I_x$  and  $I_y$  are the current values on the load line at bias voltages of  $E_{c1} = V - 0.707V = 0.293V$  and  $E_{c1} = V + 0.707V = 1.707V$ , respectively.

Calculations for distortion may be made by means of the following formu-

las. The terms used have already been defined.

% 2nd-harmonic distortion =

$$\frac{I_{\max} + I_{\min} - 2I_0}{I_{\max} - I_{\min} + 1.41(I_x - I_y)} \times 100$$

% 3rd-harmonic distortion =

$$\frac{I_{\max} - I_{\min} - 1.41(I_x - I_y)}{I_{\max} - I_{\min} + 1.41(I_x - I_y)} \times 100$$

% total (2nd and 3rd) harmonic distortion =

$$\sqrt{(\% \text{ 2nd})^2 + (\% \text{ 3rd})^2}$$

### Conversion Factors

Operating conditions for voltage values other than those shown in the published data can be obtained by use of the nomograph shown in Fig. 44 when all electrode voltages are changed simultaneously in the same ratio. The nomograph includes conversion factors for current ( $F_i$ ), power output ( $F_p$ ), plate resistance or load resistance ( $F_r$ ), and transconductance ( $F_{gm}$ ) for voltage ratios between 0.5 and 2.0. These factors are expressed as functions of the ratio between the desired or new voltage for any electrode ( $E_{des}$ ) and the published or original value of that voltage ( $E_{pub}$ ). The relations shown are applicable to triodes and multigrid tubes in all classes of service.

To use the nomograph, simply place a straight-edge across the page so that it intersects the scales for  $E_{des}$  and  $E_{pub}$  at the desired values. The desired conversion factor may then be read directly or estimated at the point where the straight-edge intersects the  $F_i$ ,  $F_p$ ,  $F_r$ , or  $F_{gm}$  scale.

For example, suppose it is desired to operate two 6L6GC's in class A<sub>1</sub> push-pull, fixed bias, with a plate voltage of 200 volts. The nearest published operating conditions for this class of service are for a plate voltage of 250 volts. The operating conditions for the new plate voltage can be determined as follows:

The voltage conversion factor,  $F_v$ , is equal to 200/250 or 0.8. The dashed lines on the nomograph of Fig. 44 indicate that for this voltage ratio  $F_i$  is approximately 0.72,  $F_p$  is approximately 0.57,  $F_r$  is 1.12, and  $F_{gm}$  is approximately 0.892. These factors may be applied directly to operating values shown in the tube data, or to values calculated by the methods described previously.

Because this method for conversion

of characteristics is necessarily an approximation, the accuracy of the nomograph decreases progressively as the ratio  $E_{des}/E_{pub}$  departs from unity. In general, results are substantially correct when the value of the ratio  $E_{des}/E_{pub}$  is between 0.7 and 1.5. Beyond these limits, the accuracy decreases rapidly, and the results obtained must be considered rough approximations.

The nomograph does not take into consideration the effects of contact potential or secondary emission in tubes. Because contact-potential effects become noticeable only at very small dc grid-No. 1 (bias) voltages, they are generally negligible in power tubes. Secondary emission may occur in conventional tetrodes, however, if the plate voltage swings below the grid-No. 2 voltage. Consequently, the conversion

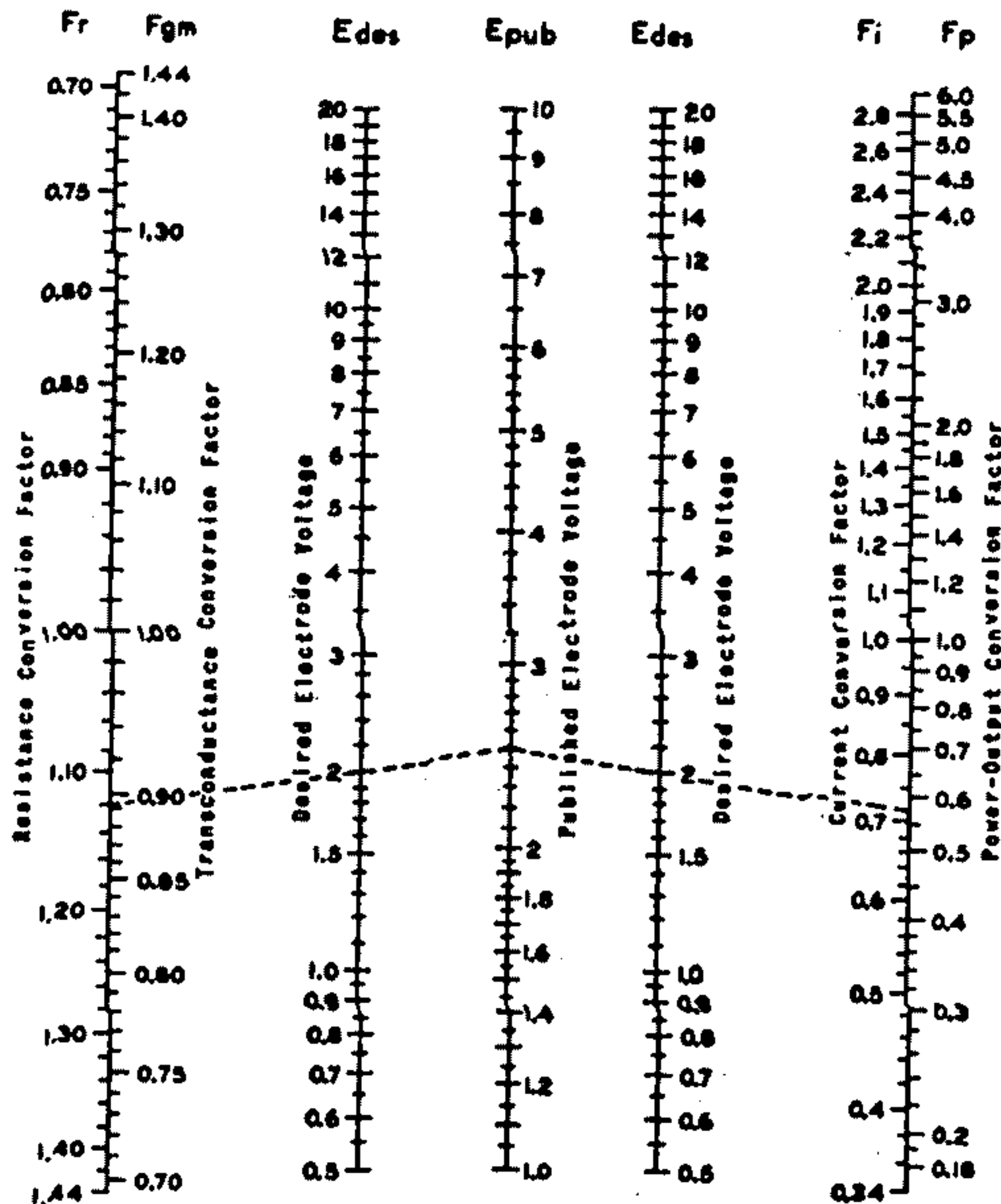


Fig. 44—Nomograph of tube conversion factors.



factors shown in the nomograph apply to such tubes only when the plate voltage is greater than the grid-No. 2 voltage. Because secondary emission may also occur in certain beam power tubes at very low values of plate current and plate voltage, the conversion factors shown in the nomograph do not apply when these tubes are operated under such conditions.

### Class AB Power Amplifiers

A class AB power amplifier employs two tubes connected in push-pull with a higher negative grid bias than is used in a class A stage. With this higher negative bias, the plate and screen-grid voltages can usually be made higher than for class A amplifiers because the increased negative bias holds plate current within the limit of the tube plate-dissipation rating. As a result of these higher voltages, more power output can be obtained from class AB operation.

Class AB amplifiers are subdivided into class AB<sub>1</sub> and class AB<sub>2</sub>. In class AB<sub>1</sub>, there is no flow of grid current. That is, the peak signal voltage applied to each grid is not greater than the negative grid-bias voltage. The grids therefore are not driven to a positive potential and do not draw current. In class AB<sub>2</sub>, the peak signal voltage is greater than the bias so that the grids are driven positive and draw current.

Because of the flow of grid current in a class AB<sub>2</sub> stage, there is a loss of power in the grid circuit. The sum of this loss and the loss in the input transformer is the total driving power required by the grid circuit. The driver stage should be capable of a power output considerably larger than this required power in order that distortion introduced in the grid circuit be kept low. The input transformer used in a class AB<sub>2</sub> amplifier usually has a step-down turns ratio.

Because of the large fluctuations of plate current in a class AB<sub>2</sub> stage, it is important that the plate power supply have good regulation. Otherwise the fluctuations in plate current cause fluctuations in the voltage output of the power supply, with the result that power output is decreased and distortion is increased. To obtain satisfactory regulation, it is usually advisable to use a low-drop rectifier, such as the 5V4GA, with a choke-input filter. In all cases, the resistance of the choke and transformers should be as low as possible.

### Class AB<sub>1</sub> Power Amplifiers

In class AB<sub>1</sub> push-pull amplifier service using triodes, the operating conditions may be determined graphically by means of the plate family if  $E_c$ , the desired operating plate voltage, is given. In this service, the dynamic load line does not pass through the operating point P as in the case of the single-tube amplifier, but through the point D in Fig. 45. Its position is not affected by the operating grid bias provided the plate-to-plate load resistance remains constant.

Under these conditions, grid bias has no appreciable effect on the power

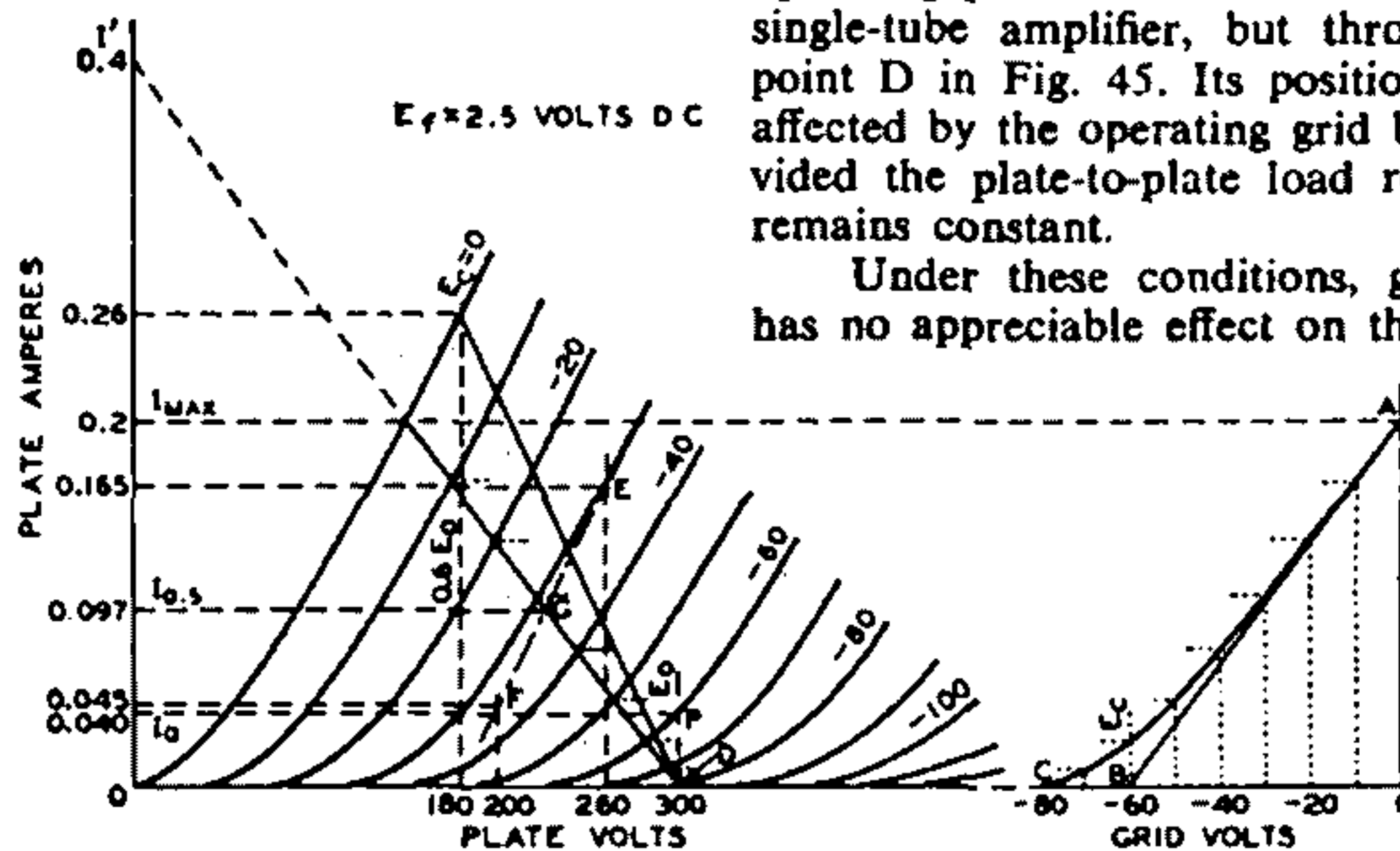


Fig. 45—Graphic calculations for class AB<sub>1</sub> amplifier using a power triode. Fig. 46—Instantaneous curve for class AB<sub>1</sub> amplifier.

output. Grid bias cannot be neglected, however, since it is used to find the zero-signal plate current and, from it, the zero-signal plate dissipation. Because the grid bias is higher in class AB<sub>1</sub> than in class A service for the same plate voltage, a higher signal voltage may be used without grid current being drawn and, therefore, higher power output is obtained.

In general, for any load line through point D, Fig. 45, the plate-to-plate load resistance in ohms of a push-pull amplifier is  $R_{pp} = 4E_o/I'$ , where  $I'$  is the plate-current value in amperes at which the load line as projected intersects the plate-current axis, and  $E_o$  is in volts. This formula is another form of the one given under push-pull class A amplifiers,  $R_{pp} = 4(E_o - 0.6E_o)/I_{max}$ , but is more general. Power output  $= (I_{max}/\sqrt{2})^2 \times R_{pp}/4$ , where  $I_{max}$  is the peak plate current at zero grid volts for the load chosen. This formula simplified is  $(I_{max})^2 \times R_{pp}/8$ . The maximum-signal average plate current is  $2I_{max}/\pi$  or  $0.636 I_{max}$ ; the maximum-signal average power input is  $0.636 I_{max} \times E_o$ .

It is desirable to simplify these formulas for a first approximation. This simplification can be made if it is assumed that the peak plate current,  $I_{max}$ , occurs at the point of the zero-bias curve corresponding approximately to  $0.6 E_o$ , the condition for maximum power output. The simplified formulas are:

$$P_o \text{ (for two tubes)} = (I_{max} \times E_o)/5$$

$$R_{pp} = 1.6E_o/I_{max}$$

where  $E_o$  is in volts,  $I_{max}$  is in amperes,  $R_{pp}$  is in ohms, and  $P_o$  is in watts.

It may be found during subsequent calculations that the distortion or the plate dissipation is excessive for this approximation; in that case, a different load resistance must be selected, using the first approximation as a guide, and the process repeated to obtain satisfactory operating conditions.

**Example:** Fig. 45 illustrates the application of this method to a pair of power triodes operated at  $E_o = 300$  volts. Each tube has a plate-dissipation rating of 15 watts. The method is to

erect a vertical line at  $0.6E_o$ , or at 180 volts, which intersects the  $E_c = 0$  curve at the point  $I_{max} = 0.26$  ampere. Using the simplified formulas, the following values are obtained:

$$R_{pp} = (1.6 \times 300)/0.26 = 1845 \text{ ohms}$$

$$P_o = (0.26 \times 300)/5 = 15.6 \text{ watts}$$

At this point, it is well to determine the plate dissipation and to compare it with the maximum rated value. From the average-plate-current formula ( $0.636 I_{max}$ ) mentioned previously, the maximum-signal average plate current is 0.166 ampere. The product of this current and the operating plate voltage is 49.8 watts, the average input to the two tubes. From this value, subtract the power output of 15.6 watts to obtain the total dissipation for both tubes, which is 34.2 watts. Half of this value, 17 watts, is in excess of the 15-watt rating of the tube and it is necessary, therefore, to assume another and higher load resistance so that the plate-dissipation rating will not be exceeded.

It will be found that at an operating plate voltage of 300 volts the tubes require a plate-to-plate load resistance of 3000 ohms. From the formula for  $R_{pp}$ , the value of  $I'$  is found to be 0.4 ampere. The load line for the 3000-ohm load resistance is then represented by a straight line from the point  $I' = 0.4$  ampere on the plate-current ordinate to the point  $E_o = 300$  volts on the plate-voltage abscissa. At the intersection of the load line with the zero-bias curve, the peak plate current,  $I_{max}$ , can be read at 0.2 ampere. Then

$$P_o = (I_{max}/\sqrt{2})^2 \times R_{pp}/4$$

$$= (0.2/1.41)^2 \times 3000/4$$

$$= 15 \text{ watts}$$

Proceeding as in the first approximation, it is found that the maximum-signal average plate current,  $0.636I_{max}$ , is 0.127 ampere, and the maximum-signal average power input is 38.1 watts. This input minus the power output is  $38.1 - 15 = 23.1$  watts. This value is the dissipation for two tubes; the value per tube is 11.6 watts, a value well within the rating of this tube type.

The operating bias and the zero-signal plate current may then be found by use of a curve which is derived from



the plate family and the load line. Fig. 46 is a curve of instantaneous values of plate current and dc grid-bias voltages taken from Fig. 45. Values of grid bias are read from each of the grid-bias curves of Fig. 45 along the load line and are transferred to Fig. 46 to produce the curved line from A to C. A tangent to this curve, starting at A, is drawn to intersect the grid-voltage abscissa. The point of intersection, B, is the operating grid bias for fixed-bias operation. In the example, the bias is  $-60$  volts. Refer back to the plate family at the operating conditions of plate volts = 300 and grid bias =  $-60$  volts; the zero-signal plate current per tube is seen to be 0.04 ampere.

This procedure locates the operating point for each tube at P. The plate current must be doubled, of course, to obtain the zero-signal plate current for both tubes. Under maximum-signal conditions, the signal voltage swings from zero-signal bias voltage to zero bias for each tube on alternate half cycles. Hence, in the example, the peak of signal voltage per tube is 60 volts, or the grid-to-grid value is 120 volts.

As in the case of the push-pull class A amplifier, the second-harmonic distortion in a class AB<sub>1</sub> amplifier using triodes is very small and is largely canceled by virtue of the push-pull connection. Third-harmonic distortion, however, which may be larger than permissible, can be found by means of composite characteristic curves. A complete family of curves can be plotted, but for the present purpose only the one corresponding to a grid bias of one-half the peak grid-voltage swing is needed. In the example, the peak grid voltage per tube is 60 volts, and the half value is 30 volts. The composite curve, since it is nearly a straight line, can be constructed with only two points (see Fig. 45). These two points are obtained from deviations above and below the operating grid and plate voltages.

In order to find the curve for a bias of  $-30$  volts, a deviation of 30 volts from the operating grid voltage of  $-60$  volts is assumed. Next assume a deviation from the operating plate voltage of, say, 40 volts. Then at 300

$-40 = 260$  volts, erect a vertical line to intersect the  $(-60) - (-30) = -30$ -volt bias curve and read the plate current at this intersection, which is 0.167 ampere; likewise, at the intersection of a vertical line at  $300 + 40 = 340$  volts and the  $(-60) + (-30) = -90$ -volt bias curve, read the plate current. In this example, the plate current is estimated to be 0.002 ampere. The difference of 0.165 ampere between these two currents determines the point E on the  $300 - 40 = 260$ -volt vertical. Similarly, another point F on the same composite curve is found by assuming the same grid-bias deviation but a larger plate-voltage deviation, say, 100 volts.

These steps provide points at 260 volts and 0.165 ampere (E), and at 200 volts and 0.045 ampere (F). A straight line through these points is the composite curve for a bias of  $-30$  volts, shown as a long-short dash line in Fig. 45. At the intersection of the composite curve and the load line, G, the instantaneous composite plate current at the point of one-half the peak signal swing is determined. This current value, designated  $I_{0.5}$  and the peak plate current,  $I_{max}$ , are used in the following formula to find the peak value of the third-harmonic component of plate current.

$$I_{h3} = (2I_{0.5} - I_{max})/3$$

In the example, where  $I_{0.5}$  is 0.097 ampere and  $I_{max}$  is 0.2 ampere,  $I_{h3} = (2 \times 0.097 - 0.2)/3 = (0.194 - 0.2)/3 = -0.006/3 = -0.002$  ampere. (The fact that  $I_{h3}$  is negative indicates that the phase relation of the fundamental (first-harmonic) and third-harmonic components of the plate current is such as to result in a slightly peaked wave form.  $I_{h3}$  is positive in some cases, indicating a flattening of the wave form.)

The peak value of the fundamental or first-harmonic component of the plate current is found by the following formula:

$$I_{h1} = 2/3 \times (I_{max} + I_{0.5})$$

In the example,  $I_{h1} = 2/3 \times (0.2 + 0.097) = 0.198$  ampere. Thus, the percentage of third-harmonic distortion is  $(I_{h3}/I_{h1}) \times 100 = (0.002/0.198) \times 100 = 1$  per cent approx.

*Class AB<sub>2</sub> Power Amplifiers*

A class AB<sub>2</sub> amplifier employs two tubes connected in push-pull as in the case of class AB<sub>1</sub> amplifiers. It differs in that it is biased so that plate current flows for somewhat more than half the electrical cycle but less than the full cycle, the peak signal voltage is greater than the dc bias voltage, grid current is drawn, and, consequently, power is consumed in the grid circuit. These conditions permit high power output to be obtained without excessive plate dissipation.

The sum of the power used in the grid circuit and the losses in the input transformer is the total driving power required by the grid circuit. The driver stage should be capable of a power output considerably larger than this required power in order that distortion introduced in the grid circuit be kept low. In addition, the internal impedance of the driver stage as reflected into or as effective in the grid circuit of the power stage should always be as low as possible in order that distortion may be kept low. The input transformer used in a class AB<sub>2</sub> stage usually has a step-down ratio adjusted for this condition.

Load resistance, plate dissipation, power output, and distortion determinations are similar to those for class AB<sub>1</sub>. These quantities are interdependent with peak grid-voltage swing and driving power; a satisfactory set of operating conditions involves a series of approximations. The load resistance and signal swing are limited by the permissible grid current and power and the distortion. If the load resistance is too high or the signal swing is excessive, the plate-dissipation rating will be exceeded, distortion will be high, and the driving power will be unnecessarily high.

*Class B Power Amplifiers*

A class B amplifier employs two tubes connected in push-pull, so biased that plate current is almost zero when no signal voltage is applied to the grids. Because of this low value of no-signal plate current, class B amplification has the same advantage as class AB<sub>2</sub>, *i.e.*, large power output can be obtained without excessive plate dissipation.

Class B operation differs from class AB<sub>2</sub> in that plate current is cut off for a larger portion of the negative grid swing, and the signal swing is usually larger than in class AB<sub>2</sub> operation.

Because certain triodes used as class B amplifiers are designed to operate very close to zero bias, the grid of each tube is at a positive potential during all or most of the positive half-cycle of its signal swing. In this type of triode operation, considerable grid current is drawn and there is a loss of power in the grid circuit. This condition imposes the same requirement in the driver stage as in a class AB<sub>2</sub> stage; *i.e.*, the driver should be capable of delivering considerably more power output than the power required for the grid circuit of the class B amplifier so that distortion will be low. Similarly, the interstage transformer between the driver and the class B stage usually has a step-down turns ratio. Because of the high dissipations involved in class B operation at zero bias, it is not feasible to use tetrodes or pentodes in this type of class B operation.

Determination of load resistance, plate dissipation, power output, and distortion is similar to that for a class AB<sub>2</sub> stage.

Power amplifier tubes designed for class A operation can be used in class AB<sub>2</sub> and class B service under suitable operating conditions. There are several tube types designed especially for class B service. The characteristic common to all of these types is a high amplification factor. With a high amplification factor, plate current is small even when the grid bias is zero. These tubes, therefore, can be operated in class B service at a bias of zero volts so that no bias supply is required. A number of class B amplifier tubes consist of two triode units mounted in one tube. The two units can be connected in push-pull so that only one tube is required for a class B stage.

*Cathode-Drive Circuits*

The preceding text has discussed the use of tubes in the conventional grid-drive type of amplifier—that is,



where the cathode is common to both the input and output circuits. Tubes may also be employed as amplifiers in circuit arrangements which utilize the grid or plate as the common terminal. Probably the most important of these amplifiers are the cathode-drive circuit, which is discussed below, and the cathode-follower circuit, which will be discussed later in connection with inverse feedback.

A typical cathode-drive circuit is shown in Fig. 47. The load is placed in

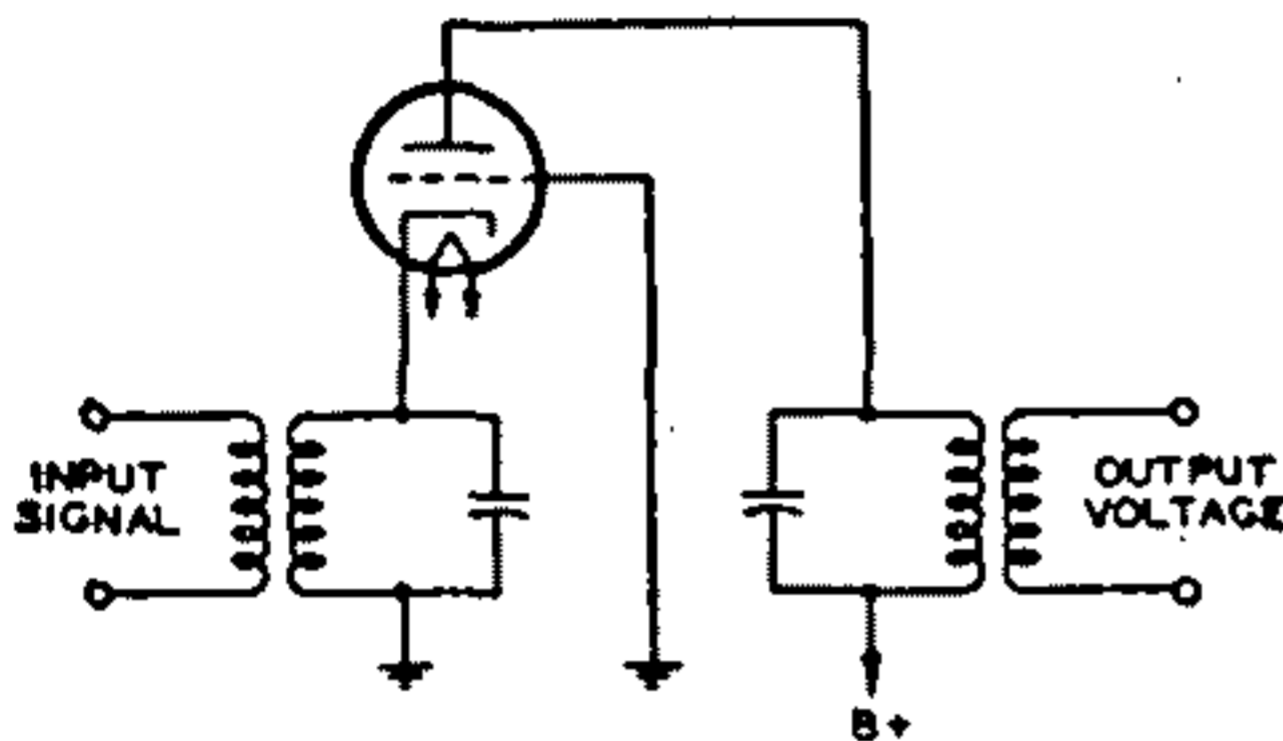


Fig. 47—Cathode-drive circuit.

the plate circuit and the output voltage is taken off between the plate and ground as in the grid-drive method of operation. The grid is grounded, and the input voltage is applied across an appropriate impedance in the cathode circuit. The cathode-drive circuit is particularly useful for vhf and uhf applications, in which it is necessary to obtain the low-noise performance usually associated with a triode, but where a conventional grid-drive circuit would be unstable because of feedback through the grid-to-plate capacitance of the tube. In the cathode-drive circuit, the grounded grid serves as a capacitive shield between plate and cathode and permits stable operation at frequencies higher than those in which conventional circuits can be used.

The input impedance of a cathode-drive circuit is approximately equal to  $1/g_m$  when the load resistance is small compared to the  $r_p$  of the tube. A certain amount of power is required, therefore, to drive such a circuit. However, in the type of service in which cathode-drive circuits are normally used, the advantages of the grounded-grid connection usually outweigh this disadvantage.

### Inverse Feedback

An inverse-feedback circuit, sometimes called a degenerative circuit, is one in which a portion of the output voltage of a tube is applied to the input of the same or a preceding tube in opposite phase to the signal applied to the tube. Two important advantages of feedback are (1) reduced distortion from each stage included in the feedback circuit and (2) reduction in the variations in gain due to changes in line voltage, possible differences between tubes of the same type, or variations in the values of circuit constants included in the feedback circuit.

Inverse feedback is used in audio amplifiers to reduce distortion in the output stage where the load impedance on the tube is a loudspeaker. Because the impedance of a loudspeaker is not constant for all audio frequencies, the load impedance on the output tube varies with frequency. When the output tube is a pentode or beam power tube having high plate resistance, this variation in plate load impedance can, if not corrected, produce considerable frequency distortion. Such frequency distortion can be reduced by means of inverse feedback. Inverse-feedback circuits are of the constant-voltage type and the constant-current type.

The application of the constant-voltage type of inverse feedback to a power-output stage using a single beam power tube is illustrated in Fig. 48. In this circuit,  $R_1$ ,  $R_2$ , and  $C$  are connected as a voltage divider across the output of the tube. The secondary winding of the grid-input transformer is returned to a point on this voltage divider. Capacitor

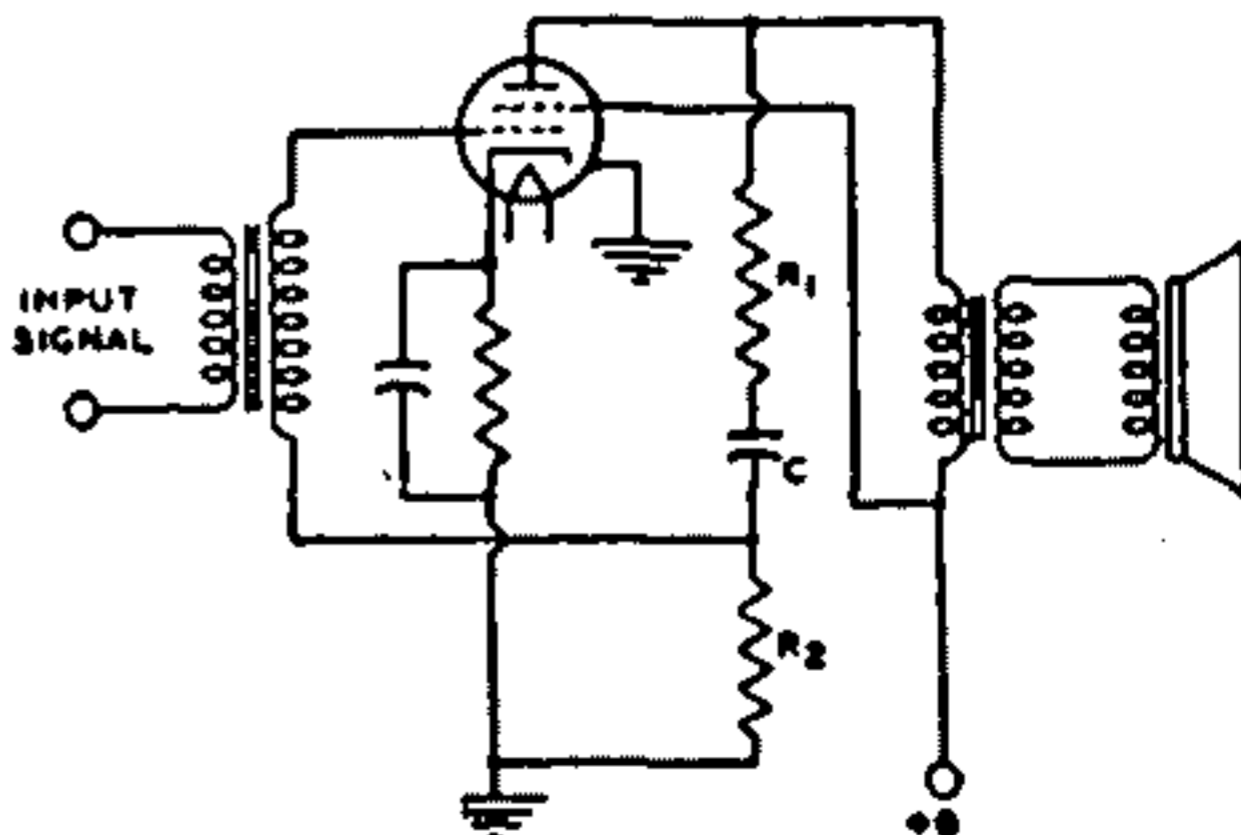


Fig. 48—Power-output stage using constant-voltage inverse feedback.

C blocks the dc plate voltage from the grid. However, a portion of the tube af output voltage, approximately equal to the output voltage multiplied by the fraction  $R_2/(R_1 + R_2)$ , is applied to the grid. This voltage reduces the source impedance of the circuit and a decrease in distortion results which is explained in the curves of Fig. 49.

It is evident that the irregularity of the waveform of this component of plate current would act to cancel the original irregularity and thus reduce distortion.

After inverse feedback has been applied, the relations are as shown in the curve for  $i_p$ . The dotted curve shown by  $i'_{p1}$  is the component of plate current

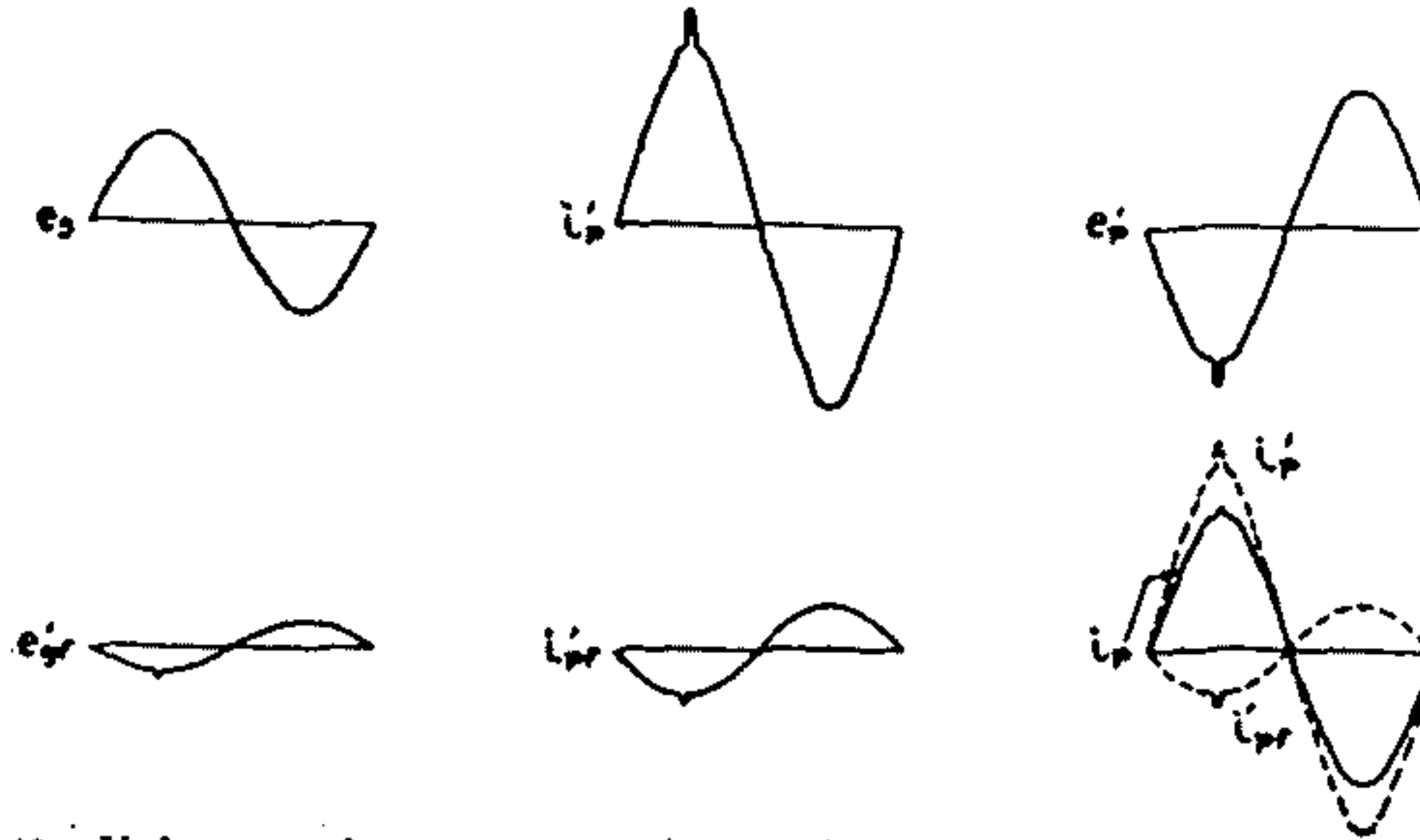


Fig. 49—Voltage and current waveforms showing effect of inverse feedback.

Consider first the amplifier without the use of inverse feedback. Suppose that when a signal voltage  $e_s$  is applied to the grid the af plate current  $i'_p$  has an irregularity in its positive half-cycle. This irregularity represents a departure from the waveform of the input signal and is, therefore, distortion. For this plate-current waveform, the af plate voltage has a waveform shown by  $e'_p$ . The plate-voltage waveform is inverted compared to the plate-current waveform because a plate-current increase produces an increase in the drop across the plate load. The voltage at the plate is the difference between the drop across the load and the supply voltage; thus, when plate current goes up, plate voltage goes down; when plate current goes down, plate voltage goes up.

Now suppose that inverse feedback is applied to the amplifier. The voltage fed back to the grid has the same waveform and phase as the plate voltage, but is smaller in magnitude. Hence, with a plate voltage of waveform shown by  $e'_p$ , the feedback voltage appearing on the grid is as shown by  $e'_{gs}$ . This voltage applied to the grid produces a compo-

due to the feedback voltage on the grid. The dotted curve shown by  $i'_{p1}$  is the component of plate current due to the signal voltage on the grid. The algebraic sum of these two components gives the resultant plate current shown by the solid curve of  $i_p$ . Since  $i'_{p1}$  is the plate current that would flow without inverse feedback, it can be seen that the application of inverse feedback has reduced the irregularity in the output current. In this manner inverse feedback acts to correct any component of plate current that does not correspond to the input signal voltage, and thus reduces distortion.

From the curve for  $i_p$ , it can be seen that, besides reducing distortion, inverse feedback also reduces the amplitude of the output current. Consequently, when inverse feedback is applied to an amplifier there is a decrease in gain or power sensitivity as well as a decrease in distortion. Hence, the application of inverse feedback to an amplifier requires that more driving voltage be applied to obtain full power output, but this output is obtained with less distortion.



Inverse feedback may also be applied to resistance-coupled stages, as shown in Fig. 50. The circuit is conventional except that a feedback resistor,

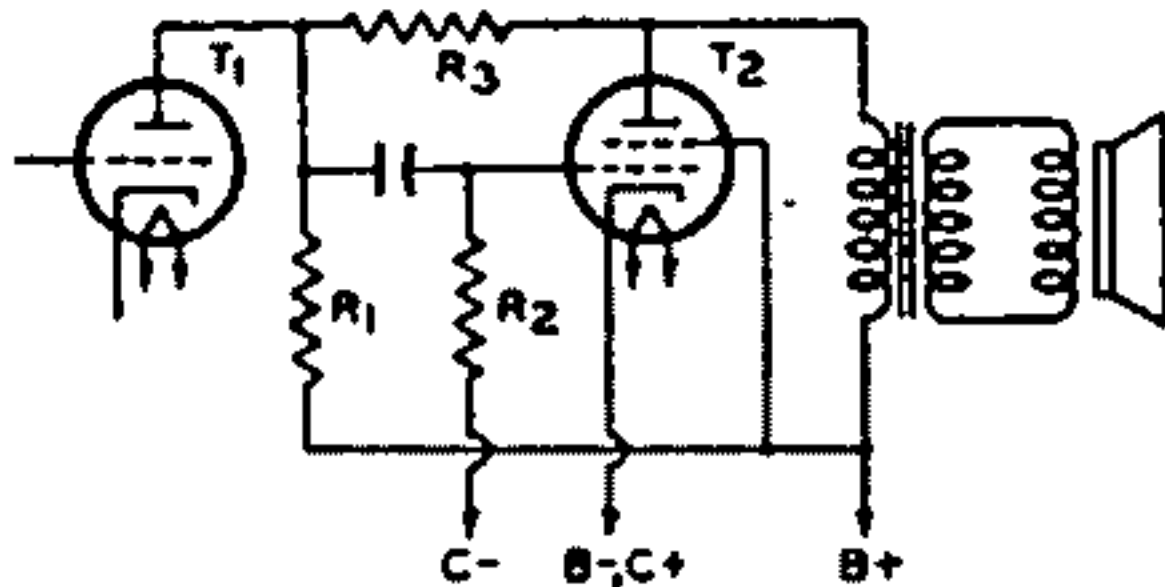


Fig. 50—Resistance-coupled stages using feedback resistor.

$R_3$  is connected between the plates of tubes  $T_1$  and  $T_2$ . The output signal voltage of  $T_1$  and a portion of the output signal voltage of  $T_2$  appear across  $R_3$ . Because the distortion generated in the plate circuit of  $T_2$  is applied to its grid out of phase with the input signal, the distortion in the output of  $T_2$  is comparatively low. With sufficient inverse feedback of the constant-voltage type in a power-output stage, it is not necessary to employ a network of resistance and capacitance in the output circuit to reduce response at high audio frequencies. Inverse-feedback circuits can also be applied to push-pull class A and class AB<sub>1</sub> amplifiers.

Constant-current inverse feedback is usually obtained by omitting the bypass capacitor across a cathode resistor. This method decreases the gain and the distortion but increases the source impedance of the circuit. Consequently, the output voltage rises at the resonant frequency of the loudspeaker and accentuates hangover effects.

Inverse feedback is not generally applied to a triode power amplifier because the variation in speaker impedance with frequency does not produce much distortion in a triode stage having low plate resistance. It is sometimes applied in a pentode stage, but is not always convenient. As has been shown, when inverse feedback is used in an amplifier, the driving voltage must be increased in order to provide full power output. When inverse feedback is used with a pentode, the total driving voltage required for full power output may be inconveniently large, although still less

than that required for a triode. Because a beam power tube gives full power output on a comparatively small driving voltage, inverse feedback is especially applicable to beam power tubes. By means of inverse feedback, the high efficiency and high power output of beam power tubes can be combined with freedom from the effects of varying speaker impedance.

### Cathode-Follower Circuits

Another important application of inverse feedback is in the cathode-follower circuit, an example of which is shown in Fig. 51. In this application, the load has been transferred from the plate circuit to the cathode circuit of the tube. The input voltage is applied between the grid and ground, and the output voltage is obtained between the cathode and ground. The voltage amplification (V.A.) of this circuit is always less than unity and may be expressed by the following convenient formulas.

For a triode:

$$V. A. = \frac{\mu \times R_L}{r_p + [R_L \times (\mu + 1)]}$$

For a pentode:

$$V. A. = \frac{g_m \times R_L}{1 + (g_m \times R_L)}$$

In these formulas,  $\mu$  is the amplification factor,  $R_L$  is the load resistance in ohms,  $r_p$  is the plate resistance in ohms, and  $g_m$  is the transconductance in mhos.

The use of the cathode follower permits the design of circuits which have high input resistance and high output voltage. The output impedance is

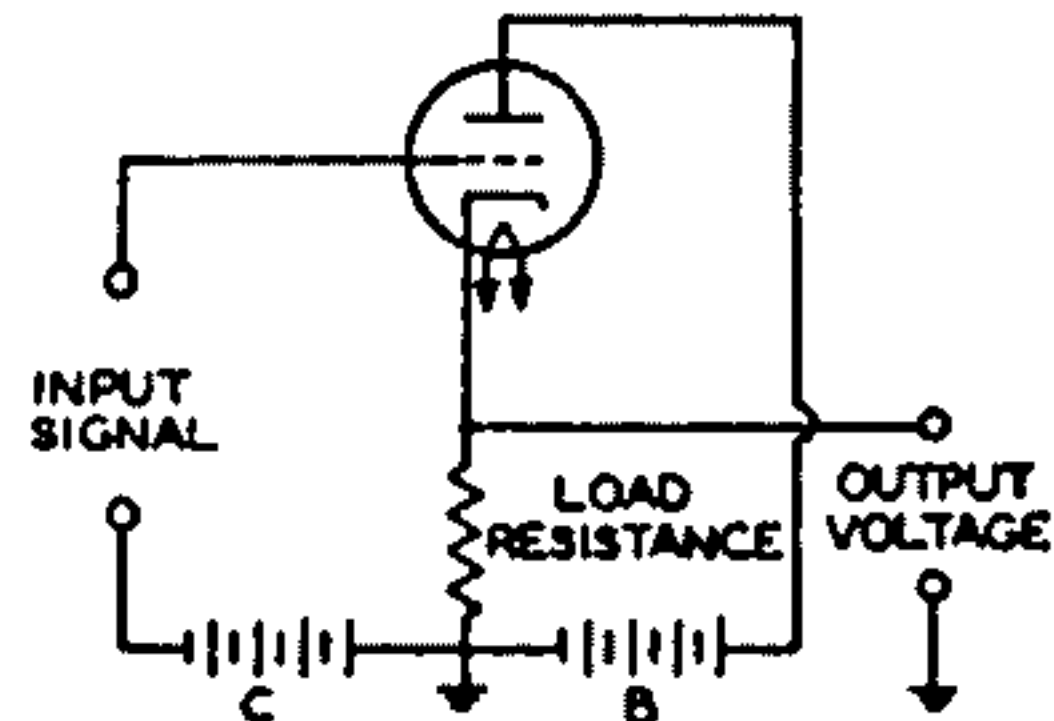


Fig. 51—Cathode-follower circuit.

quite low and very low distortion may be obtained. Cathode-follower circuits may be used for power amplifiers or as impedance transformers designed either

to match a transmission line or to produce a relatively high output voltage at a low impedance level.

In a power amplifier which is transformer coupled to the load, the same output power can be obtained from the tube as would be obtained in a conventional grid-drive type of amplifier. The output impedance is very low and provides excellent damping to the load, with the result that very low distortion can be obtained. The peak-to-peak signal voltage, however, approaches  $1\frac{1}{2}$  times the plate supply voltage if maximum power output is required from the tube. Some problems may be encountered, therefore, in the design of an adequate driver stage for a cathode-follower output system.

When a cathode-follower circuit is used as an impedance transformer, the load is usually a simple resistance in the cathode circuit of the tube. With relatively low values of cathode resistor, the circuit may be designed to supply significant amounts of power and to match the impedance of the device to a transmission line. With somewhat higher values of cathode resistor, the circuit may be used to decrease the output impedance sufficiently to permit the transmission of audio signals along a line in which appreciable capacitance is present.

The cathode follower may also be used as an isolation device to provide extremely high input resistance and low input capacitance as might be required in the probe of an oscilloscope or vacuum-tube voltmeter. Such circuits can be designed to provide effective impedance transformation with no significant loss of voltage.

Selection of a suitable tube and its operating conditions for use in a cathode-follower circuit having a specified output impedance ( $Z_o$ ) can be made, in most practical cases, by the use of the following formula to determine the approximate value of the required tube transconductance.

$$\text{Required } g_m \text{ (}\mu\text{mhos)} = \frac{1,000,000}{Z_o \text{ (ohms)}}$$

Once the required transconductance is obtained, a suitable tube and its operating conditions may be determined

from the technical data given in the **Technical Data** section. The tube selected should have a value of transconductance slightly lower than that obtained from the above expression to allow for the shunting effect of the cathode load resistance. The conversion nomograph given in Fig. 44 may be used for calculation of operating conditions for values of transconductance not included in the tabulated data. After the operating conditions have been determined, the approximate value of the required cathode load resistance may be calculated from the following formulas. For a triode:

$$\text{Cathode } R_L = \frac{Z_o \times r_p}{r_p - [Z_o \times (1 + \mu)]}$$

For a pentode:

$$\text{Cathode } R_L = \frac{Z_o}{1 - (g_m \times Z_o)}$$

Resistance and impedance values are in ohms; transconductance values are in mhos.

If the value of the cathode load resistance calculated to provide the required output impedance does not provide the required operating bias, the basic cathode-follower circuit can be modified in a number of ways. Two of the more common modifications are shown in Figs. 52 and 53.

In Fig. 52 the bias is increased by adding a bypassed resistance between

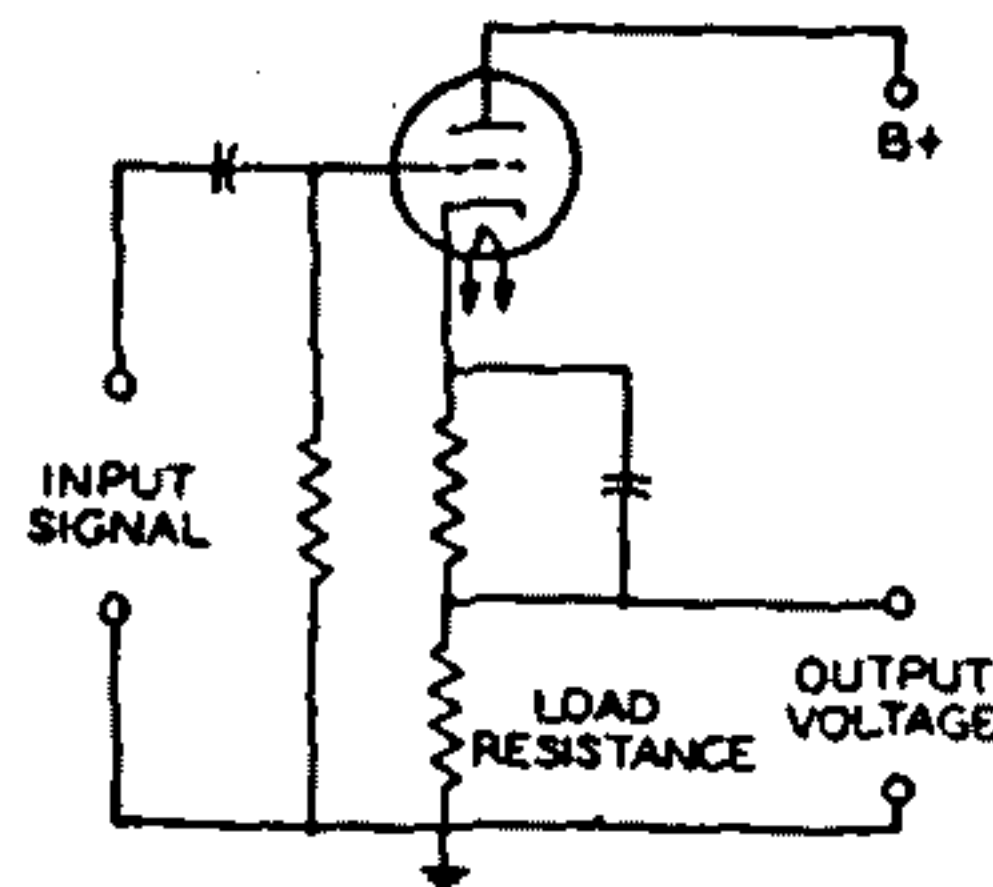


Fig. 52—Cathode-follower circuit modified for increased bias.

the cathode and the unbypassed load resistance and returning the grid to the low end of the load resistance. In Fig. 53 the bias is reduced by adding a bypassed resistance between the cathode and the unbypassed load resistance but, in this case, the grid is returned to the



junction of the two cathode resistors so that the bias voltage is only the dc voltage drop across the added resistance. The size of the bypass capacitor should be large enough so that it has negligible reactance at the lowest frequency to be handled. In both cases the B-supply should be increased to make up for the voltage taken for biasing.

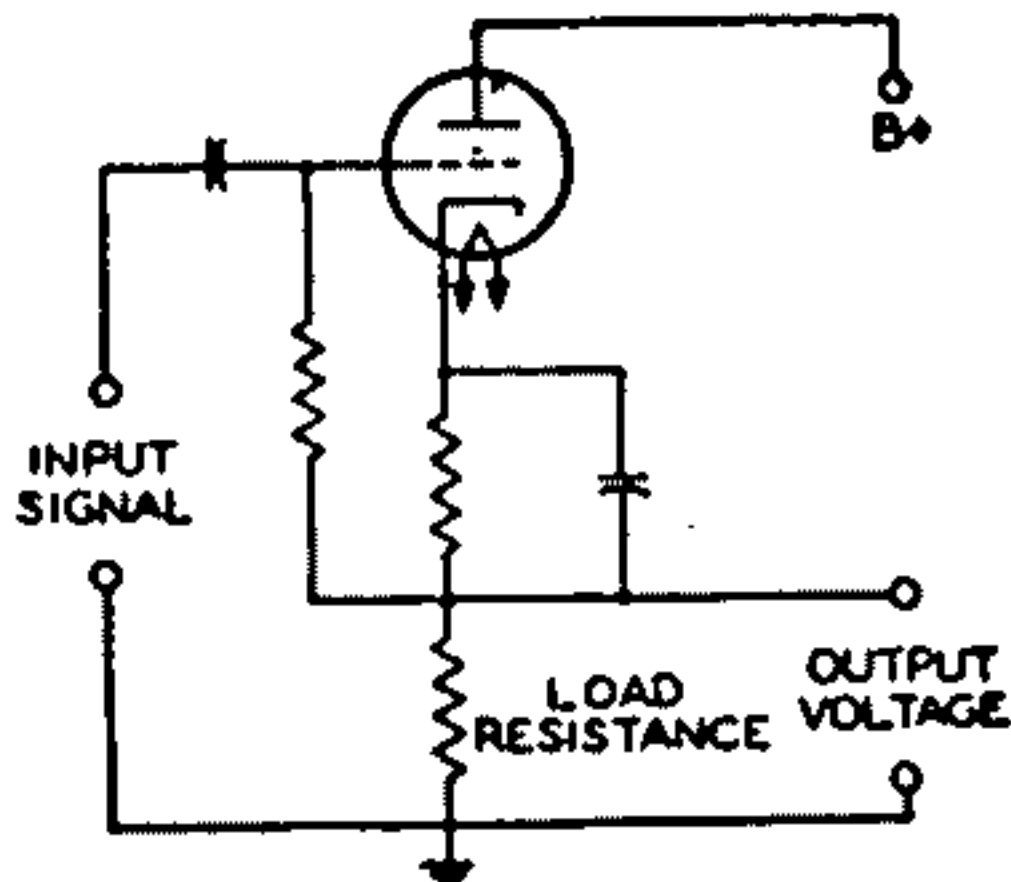


Fig. 53—Cathode-follower circuit modified for reduced bias.

**Example:** Select a suitable tube and determine the operating conditions and circuit components for a cathode-follower circuit having an output impedance that will match a 500-ohm transmission line.

**Procedure:** First, determine the approximate transconductance required.

$$\text{Required } g_m = \frac{1,000,000}{500} = 2000 \text{ } \mu\text{mhos}$$

A survey of the tubes that have a transconductance in this order of magnitude shows that type 12AX7A is among the tubes to be considered. Referring to the characteristics given in the technical data section for one triode unit of high-mu twin triode 12AX7, we find that for a plate voltage of 250 volts and a bias of  $-2$  volts, the transconductance is 1600 micromhos, the plate resistance is 62500 ohms, the amplification factor is 100, and the plate current is 0.0012 ampere. When these values are used in the expression for determining the cathode load resistance, the following result is obtained:

$$\text{Cathode } R_L = \frac{500 \times 62500}{62500 - 500 \times (100 + 1)} = 2600 \text{ ohms}$$

The voltage across this resistor for a plate current of 0.0012 ampere is  $2600 \times 0.0012 = 3.12$  volts. Because

the required bias voltage is only  $-2$  volts, the circuit arrangement given in Fig. 53 is employed. The bias is furnished by a resistance that will have a voltage drop of 2 volts when it carries a current of 0.0012 ampere. The required bias resistance, therefore, is  $2/0.0012 = 1670$  ohms. If 60 Hz is the lowest frequency to be passed, 20 microfarads is a suitable value for the bypass capacitor. The B-supply, of course, is increased by the voltage drop across the cathode resistance which, in this example, is approximately 5 volts. The B-supply, therefore, is  $250 + 5 = 255$  volts.

Because it is desirable to eliminate, if possible, the bias resistor and bypass capacitor, it is worthwhile to try other tubes and other operating conditions to obtain a value of cathode load resistance which will also provide the required bias. If the triode section of twin diode—high-mu triode 6AT6 is operated under the conditions given in the technical data section with a plate voltage of 100 volts and a bias of  $-1$  volt, it will have an amplification factor of 70, a plate resistance of 54000 ohms, a transconductance of 1300 micromhos, and a plate current of 0.0008 ampere. Then,

$$\text{Cathode } R_L = \frac{500 \times 54000}{54000 - 500 \times (70 + 1)} = 1460 \text{ ohms}$$

The bias voltage obtained across this resistance is  $1460 \times 0.0008 = 1.17$  volts. Since this value is for all practical purposes close enough to the required bias, no addition bias resistance will be required and the grid may be returned directly to ground. There is no need to adjust the B-supply voltage to make up for the drop in the cathode resistor. The voltage amplification (V.A.) for the cathode-follower circuit utilizing the triode section of type 6AT6 is

$$\text{V.A.} = \frac{70 \times 1460}{54000 + 1460 \times (70 + 1)} = 0.65$$

For applications in which the cathode follower is used to isolate two circuits—for example, when it is used between a circuit being tested and the input stage of an oscilloscope or a vacuum-tube voltmeter—voltage output

and not impedance matching is the primary consideration. In such applications it is desirable to use a relatively high value of cathode load resistance, such as 50,000 ohms, in order to get the maximum voltage output. In order to obtain proper bias, a circuit such as that of Fig. 53 should be used. With a high value of cathode resistance, the voltage amplification will approximate unity.

#### *Corrective Filters*

A corrective filter can be used to improve the frequency characteristic of an output stage using a beam power tube or a pentode when inverse feedback is not applicable. The filter consists of a resistor and a capacitor connected in series across the primary of the output transformer. Connected in this way, the filter is in parallel with the plate load impedance reflected from the voice-coil by the output transformer. The magnitude of this reflected impedance increases with increasing frequency in the middle and upper audio range. The impedance of the filter, however, decreases with increasing frequency. It follows that, by use of the proper values for the resistance and the capacitance in the filter, the effective load impedance on the output tubes can be made practically constant for all frequencies in the middle and upper audio range. The result is an improvement in the frequency characteristic of the output stage.

The resistance to be used in the filter for a push-pull stage is 1.3 times the recommended plate-to-plate load resistance; or, for a single-tube stage, is 1.3 times the recommended plate load resistance. The capacitance in the filter should have a value such that the voltage gain of the output stage at a frequency of 1000 Hz or higher is equal to the voltage gain at 400 Hz.

A method of determining the proper value of capacitance for the filter is to make two measurements of the output voltage across the primary of the output transformer: first, when a 400-Hz signal is applied to the input, and second, when a 1000-Hz signal of the same voltage as the 400-Hz signal is applied to the input. The correct value of capacitance is the one which gives equal output voltages for the two signal inputs. In practice, this value is usually found to be in the order of 0.05 microfarad.

#### *Phonograph and Tape Preamplifiers*

The frequency range and dynamic range\* which can be recorded on a phonograph record or on magnetic tape depend on several factors, including the composition, mechanical characteristics, and speed of the record or tape, and the electrical and mechanical characteristics of the recording equipment. To achieve wide frequency and dynamic ranges, manufacturers of commercial recordings use equipment which introduces a nonuniform relationship between amplitude and frequency. This relationship is known as a "recording characteristic." To assure proper reproduction of a high-fidelity recording, therefore, some part of the reproducing system must have a frequency-response characteristic which is the inverse of the recording characteristic. Most manufacturers of high-fidelity recordings use the RCA "New Orthophonic" (RIAA) characteristic for discs and the NARTB characteristic for magnetic tape.

The simplest type of equalization network is shown in Fig. 54. Because the capacitor C is effectively an open circuit at low frequencies, the low frequencies must be passed through the resistor R and are attenuated. The capacitor has a lower reactance at high



Fig. 54—Simple RC frequency-compensation network.

\* The dynamic range of an amplifier is a measure of its signal-handling capability. The dynamic range expresses in dB the ratio of the maximum usable output signal (generally for a distortion of about 10 per cent) to the minimum usable output signal (generally for a signal-to-noise ratio of about 20 dB). A dynamic range of 40 dB is usually acceptable; a value of 70 dB is exceptional for any audio system.



frequencies, however, and bypasses high-frequency components around R so that they receive negligible attenuation. Thus the network effectively "boosts" the high frequencies. This type of equalization is called "attenuative."

Some typical preamplifier stages are shown in the **Circuits** section. The location of the frequency-compensating network or "equalizer" in the reproducing system will depend on the types of recordings which are to be reproduced and on the pickup devices used.

A ceramic high-fidelity phonograph pickup is usually designed to provide proper compensation for the RIAA recording characteristic when the pickup is operated into the load resistance specified by its manufacturer. Because this type of pickup also has relatively high output (0.5 to 1.5 volts), it does not require the use of either an equalizer network or a preamplifier, and can be connected directly to the input of a tone-control amplifier and/or power amplifier.

A magnetic high-fidelity phonograph pickup, on the other hand, usually has an essentially flat frequency-response characteristic and very low output (1 to 10 millivolts). Because a pickup of this type merely reproduces the recording characteristic, it must be followed by an equalizer network, as well as by a preamplifier having sufficient voltage gain to provide the input voltage required by the tone-control amplifier and/or power amplifier. Many designs include both the equalizing and amplifying circuits in a single unit.

A high-fidelity magnetic-tape pickup head, like a magnetic phonograph pickup, reproduces the recording characteristic and has an output of only a few millivolts. This type of pickup device, therefore, must also be followed by an equalizing network and preamplifier, or by a preamplifier which provides "built-in" equalization for the NARTB characteristic.

**Feedback networks** may also be used for frequency compensation and for reduction of distortion. Basically, a feedback network returns a portion of the output signal to the input circuit of an amplifier. The feedback signal may be returned in phase with the input signal (**positive** or **regenerative feedback**) or 180 degrees out of phase with the input signal (**negative**, **inverse**, or **degenerative feedback**). In either case, the feedback can be made proportional to either the output voltage or the output current, and can be applied to either the input voltage or the input current. A negative feedback signal proportional to the output current raises the output impedance of the amplifier; negative feedback proportional to the output voltage reduces the output impedance. A negative feedback signal applied to the input current decreases the input impedance; negative feedback applied to the input voltage increases the input impedance. Opposite effects are produced by positive feedback.

A simple negative or inverse feedback network which provides high-frequency boost is shown in Fig. 55. This network provides equalization comparable to that obtained with Fig. 54, but is more suitable for low-level amplifier stages because it does not require the first amplifier stage to provide high-level low frequencies. In addition, the inverse feedback improves the distortion characteristics of the amplifier.

Some preamplifier or low-level audio amplifier circuits include variable resistors or potentiometers which function as volume or tone controls. Such circuits should be designed to minimize the flow of dc currents through these controls so that little or no noise will be developed by the movable contact during the life of the circuit. Volume controls and their associated circuits should permit variation of gain from zero to maximum, and should attenuate all frequencies equally for all positions

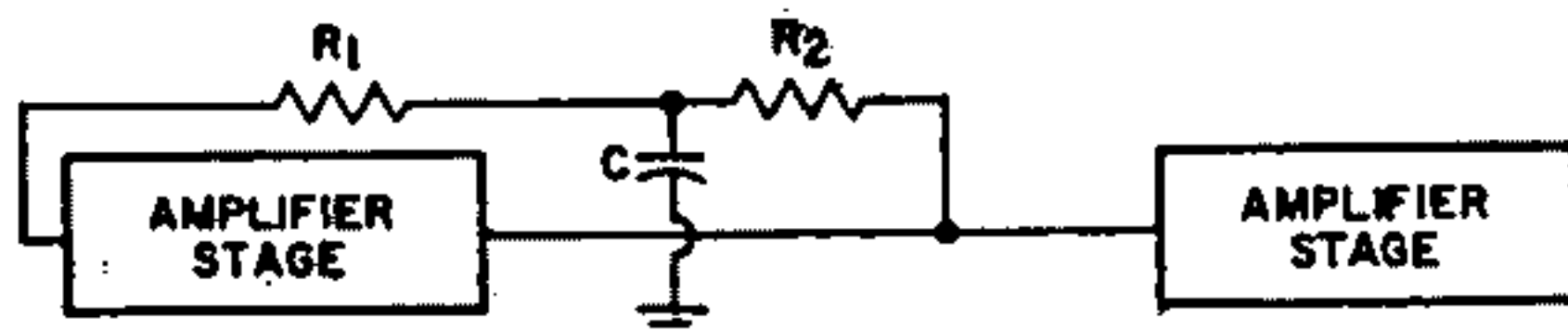


Fig. 55—Negative-feedback frequency-compensation network.

of the variable arm of the control. Several examples of volume controls and tone controls are shown in the **Circuits** section.

*Tone Controls*

A tone control is a variable filter (or one in which at least one element is adjustable) by means of which the user may vary the frequency response of an amplifier to suit his own taste. In radio receivers and home amplifiers, the tone control usually consists of a resistance-capacitance network in which the resistance is the variable element.

The simplest form of tone control is a fixed tone-compensating or "equalizing" network such as that shown in Fig. 56. This type of network is often

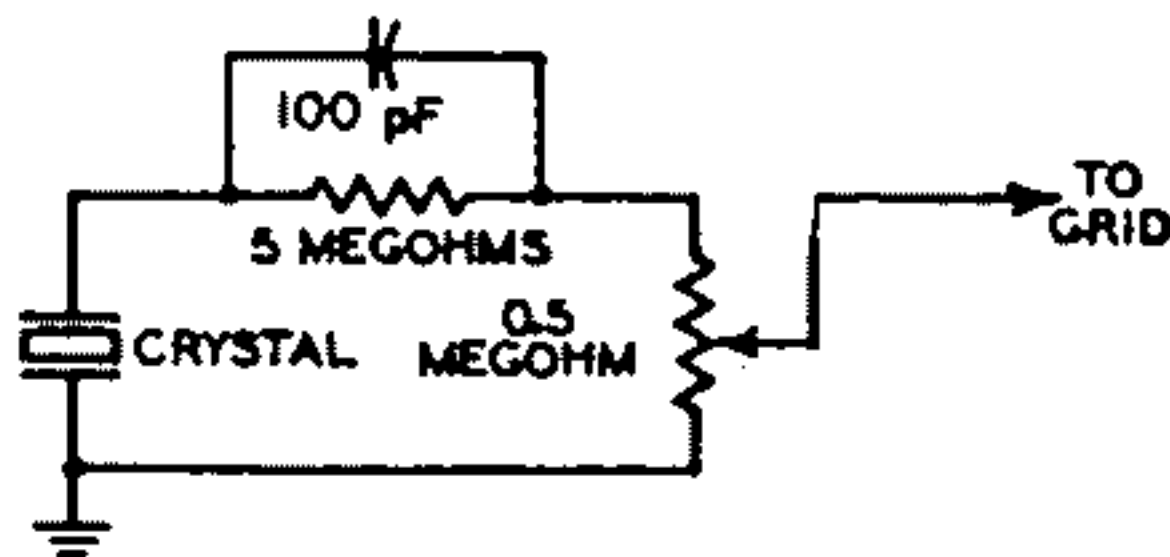


Fig. 56—Tone-control circuit for fixed tone compensation or "equalizing".

used to equalize the low- and high-frequency response of a crystal phonograph pickup. At low frequencies the attenuation of this network is 20.8 dB. As the frequency is increased, the 100-picofarad capacitor serves as a bypass for the 5-megohm resistor, and the combined impedance of the resistor-capacitor network is reduced. Thus, more of the crystal output appears across the 0.5-megohm resistor at high

frequencies than at low frequencies, and the frequency response at the grid is reasonably flat over a wide frequency range. Fig. 57 shows a comparison between the output of the crystal (curve A) and the output of the equalizing network (curve B). The response curve

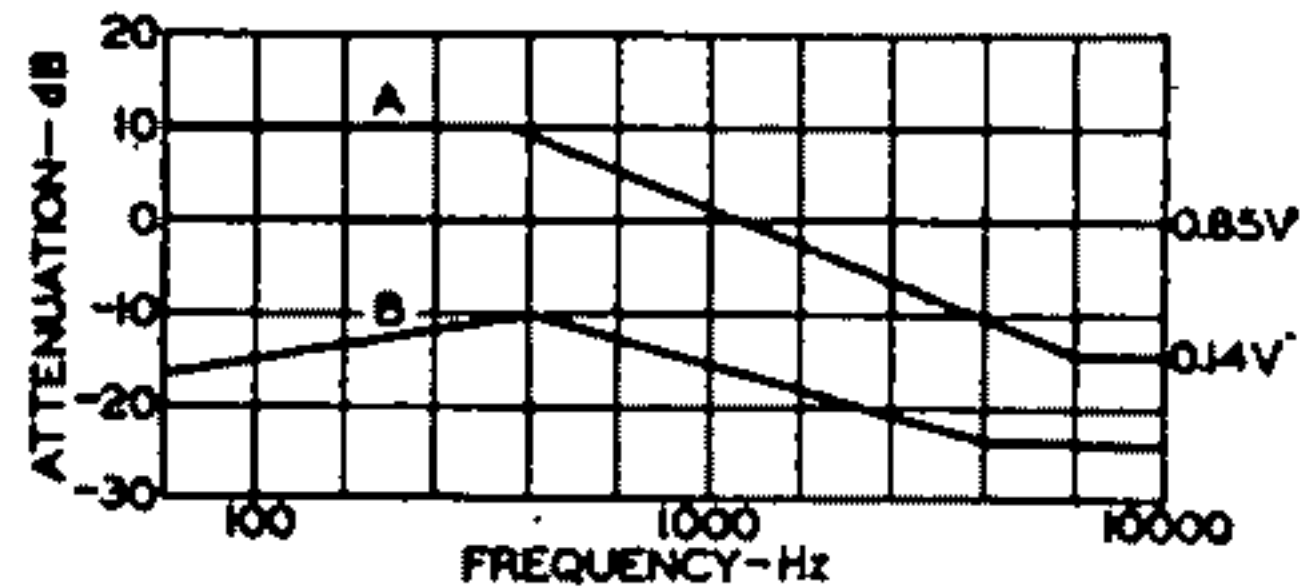


Fig. 57—Curve showing output from crystal phonograph pickup (A) and from equalizing network (B).

can be "flattened" still more if the attenuation at low frequencies is increased by changing the 0.5-megohm resistor to 0.125 megohm.

The tone-control network shown in Fig. 58 has two stages with completely separate bass and treble controls. Fig. 59 shows simplified representations of the bass control of this circuit when the potentiometer is turned to its extreme variations (usually labeled "Boost" and "Cut"). In this network, as in the crystal-equalizing network shown in Fig. 56, the parallel RC combination is the controlling factor. For bass "boost," the capacitor  $C_3$  bypasses resistor  $R_3$ , so that less impedance is placed across the output to grid B at high frequencies than at low frequencies. For bass "cut," the parallel combination is shifted so that  $C_1$  bypasses  $R_3$ , causing more high-frequency than low-frequency output. Essentially, the network is a variable-

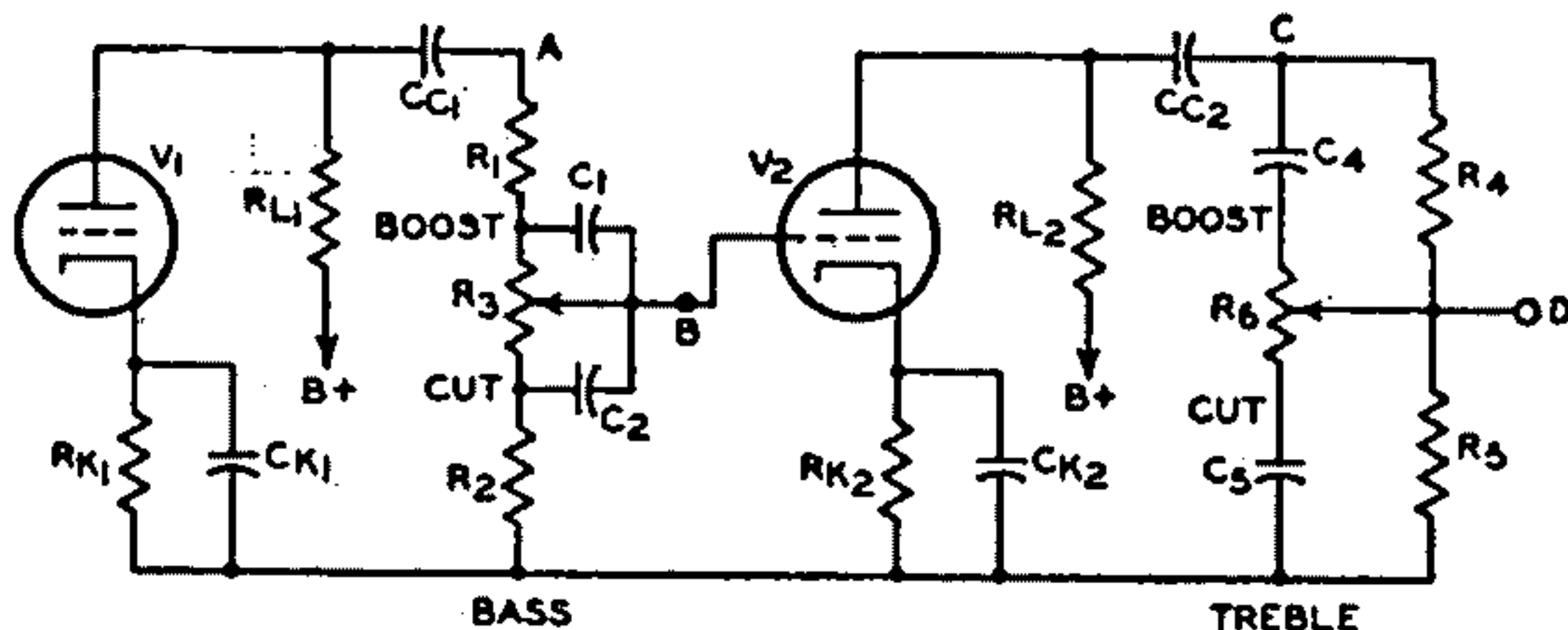


Fig. 58—Two-stage tone-control circuit incorporating separate bass and treble controls.



frequency voltage divider. With proper values for the components, it may be made to respond to changes in the  $R_3$  potentiometer setting for only low frequencies (below 1000 Hz).

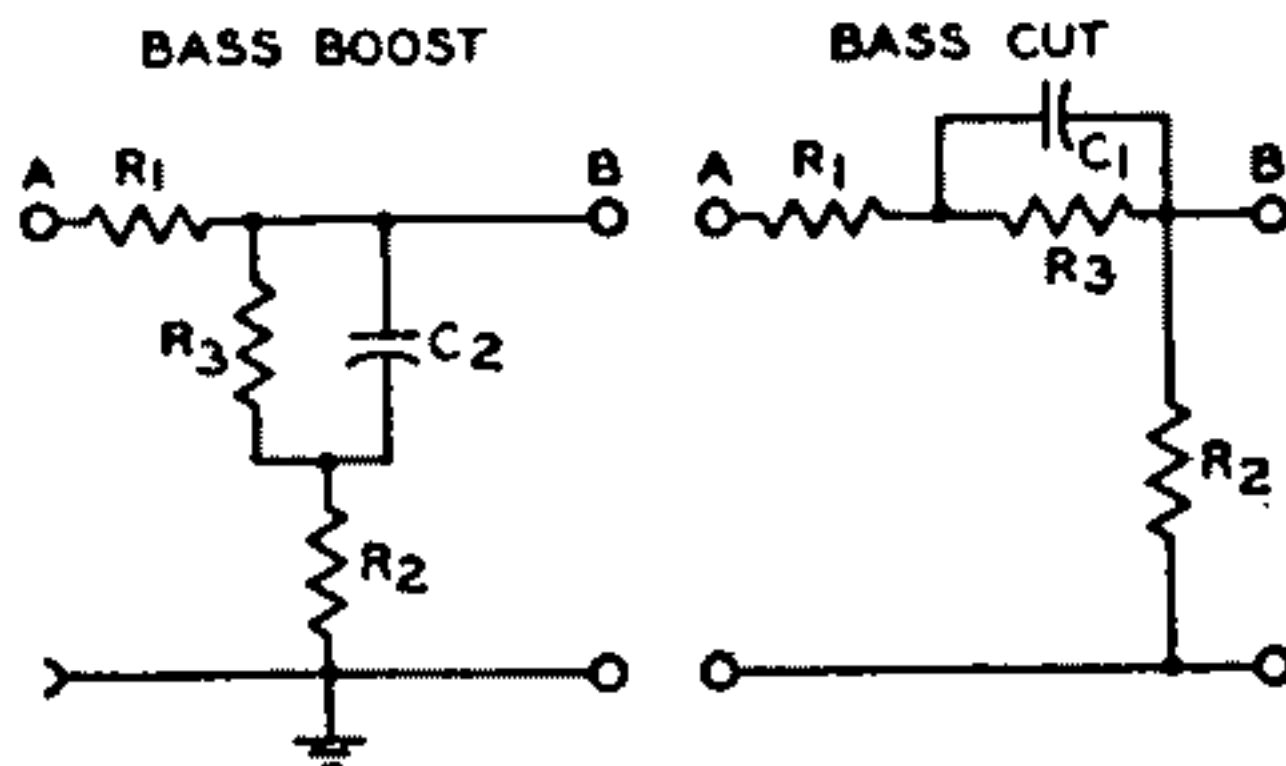


Fig. 59—Simplified representations of bass-control circuit at extreme ends of potentiometer.

Fig. 60 shows extreme positions of the treble control. The attenuation of the two circuits is approximately the same at 1000 Hz. The treble "boost" circuit is similar to the crystal-equalizing network shown in Fig. 56. In the treble "cut" circuit, the parallel RC elements serve to attenuate the signal voltage further because the capacitor bypasses the resistance across the output.

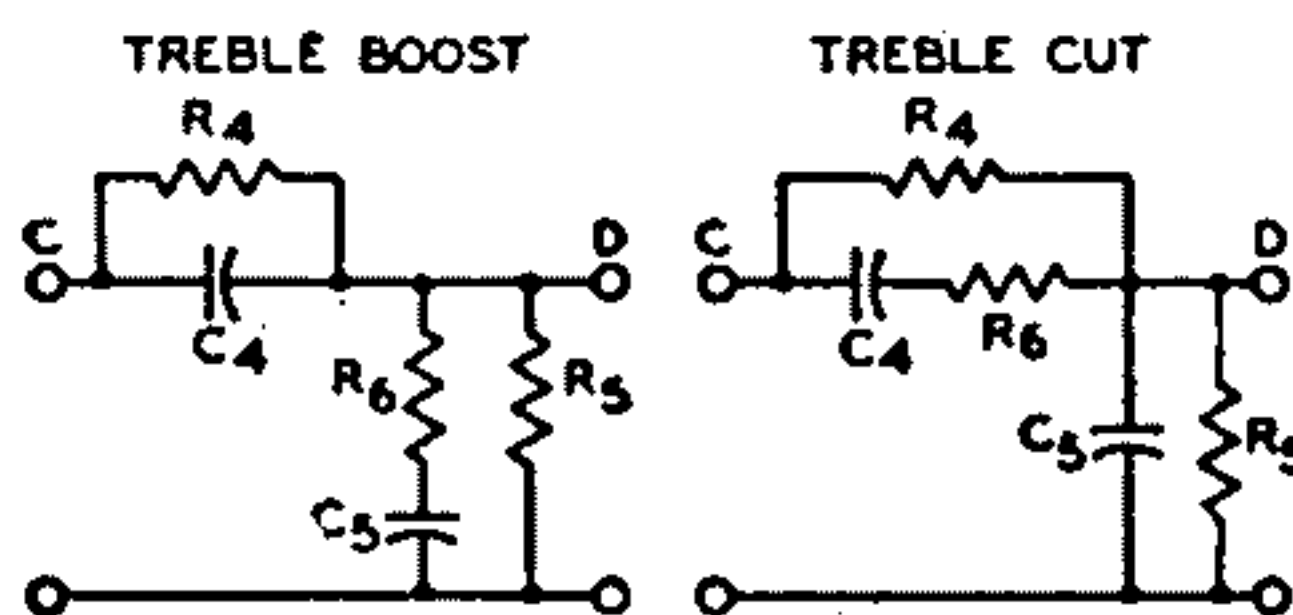


Fig. 60—Simplified representations of treble-control circuit at extreme ends of potentiometer.

The effect of the capacitor is negligible at low frequencies; beyond 1000 Hz, the signal voltage is attenuated at a maximum rate of 6 dB per octave.

The location of a tone-control network is of considerable importance. In a typical radio receiver, it may be inserted in the plate circuit of the power tube, the coupling circuit between the first af amplifier tube and the power tube, or the grid circuit of the first tube. In an amplifier using a beam power tube or pentode power amplifier without negative feedback, it is desirable to connect a resistance-

capacitance filter across the primary of the output transformer. This filter may be fixed, with a supplementary tone control elsewhere, or it may form the tone control itself. If the amplifier incorporates negative feedback, the tone control may be inserted in the feedback network or else should be connected to a part of the amplifier which is external to the feedback loop. The overall gain of a well designed tone-control network should be approximately unity.

#### Automatic Volume or Gain Control

The chief purpose of automatic volume control (avc) or automatic gain control (agc) in a radio or television receiver is to prevent fluctuations in loudspeaker volume or picture brightness when the audio or video signal at the antenna is fading in and out.

An automatic volume control circuit regulates the receiver rf and if gain so that this gain is less for a strong signal than for a weak signal. In this way, when the signal strength at the antenna changes, the avc circuit reduces the resultant change in the voltage output of the last if stage and consequently reduces the change in the speaker output volume.

The avc circuit reduces the rf and if gain for a strong signal usually by increasing the negative bias of the rf, and frequency-mixer stage when the signal increases. A simple avc circuit shown in Fig. 61. On each positive half cycle of the signal voltage, when the diode plate is positive with respect to the cathode, the diode passes current.

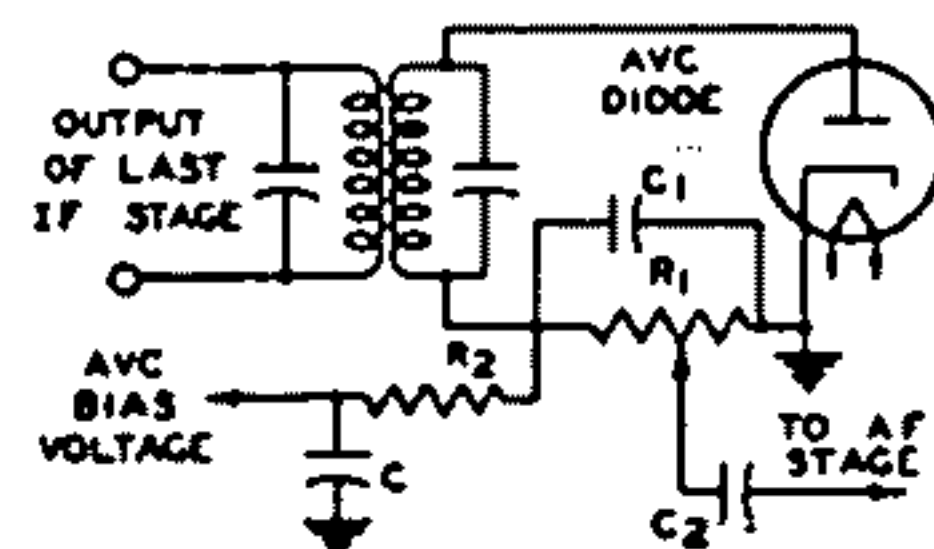


Fig. 61—Automatic-volume-control (avc) circuit.

Because of the flow of diode current through  $R_1$ , there is a voltage drop across  $R_1$  which makes the left end of  $R_1$  negative with respect to ground. This

voltage drop across  $R_1$  is applied, through the filter  $R_2$  and  $C$ , as negative bias on the grids of the preceding stages. When the signal strength at the antenna increases, therefore, the signal applied to the avc diode increases, the voltage drop across  $R_1$  increases, the negative bias voltage applied to the rf and if stages increases, and the gain of the rf and if stages is decreased. Thus the increase in signal strength at the antenna does not produce as much increase in the output of the last if stage as it would produce without avc.

When the signal strength at the antenna decreases from a previous steady value, the avc circuit acts, of course, in the reverse direction, applying less negative bias, permitting the rf and if gain to increase, and thus reducing the decrease in the signal output of the last if stage. In this way, when the signal strength at the antenna changes, the avc circuit acts to reduce change in the output of the last if stage, and thus acts to reduce change in loudspeaker volume.

The filter,  $C$  and  $R_2$ , prevents the avc voltage from varying at audio frequency. The filter is necessary because the voltage drop across  $R_1$  varies with the modulation of the carrier being received. If avc voltage were taken directly from  $R_1$  without filtering, the audio variations in avc voltage would vary the receiver gain so as to smooth out the modulation of the carrier. To avoid this effect, the avc voltage is taken from the capacitor  $C$ . Because of the resistance  $R_2$  in series with  $C$ , the capacitor  $C$  can charge and discharge at only a comparatively slow rate. The avc voltage therefore cannot vary at frequencies as high as the audio range but can vary at frequencies high enough to compensate for most fading. Thus the filter permits the avc circuit to smooth out variations in signal due to fading, but prevents the circuit from smoothing out audio modulation.

It will be seen that an avc circuit and a diode-detector circuit are much alike. It is therefore convenient in a receiver to combine the detector and the avc diode in a single stage. Examples of how these functions are combined in

receivers are shown in **Circuits** section.

In the circuit shown in Fig. 61, a certain amount of avc negative bias is applied to the preceding stages on a weak signal. Because it may be desirable to maintain the receiver rf and if gain at the maximum possible value for a weak signal, avc circuits are designed in some cases to apply no avc bias until the signal strength exceeds a certain value. These avc circuits are known as **delayed avc** or **davc** circuits.

A davc circuit is shown in Fig. 62. In this circuit, the diode section  $D_1$  of the 6AL5 acts as detector and avc diode.

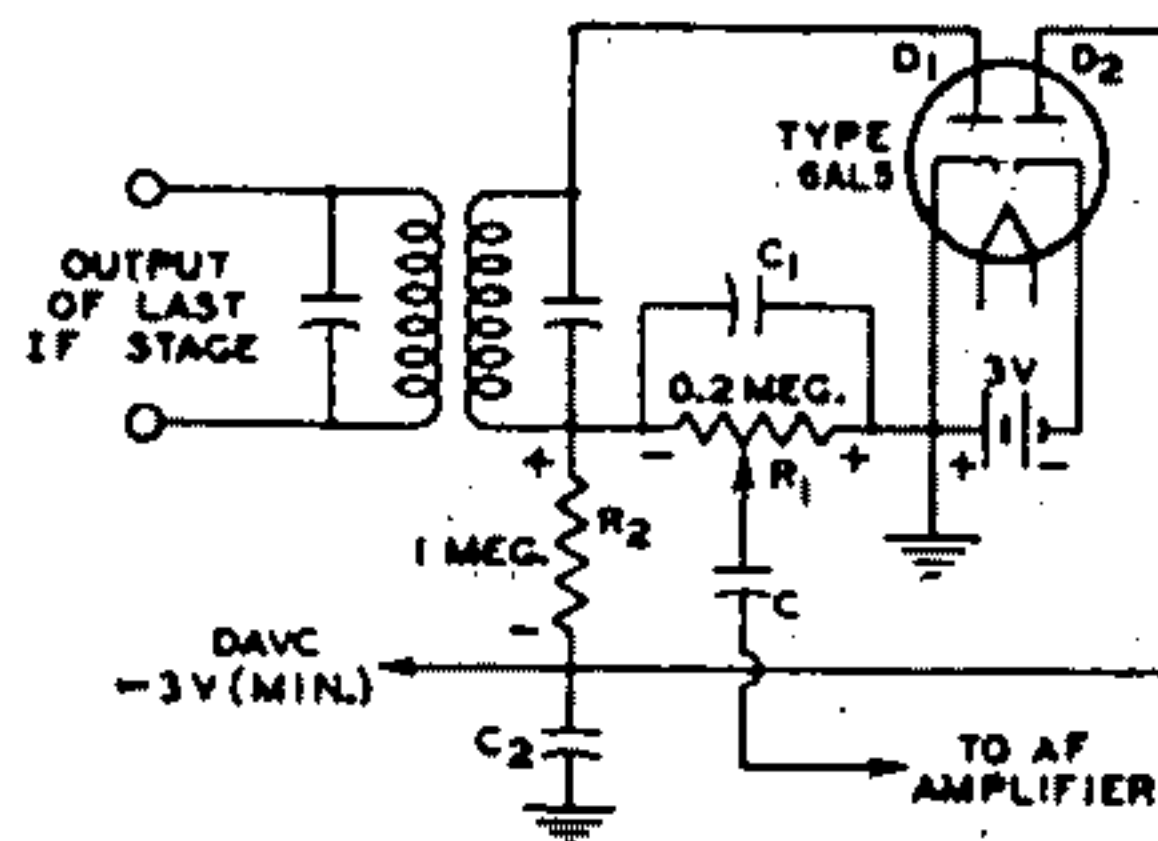


Fig. 62—Delayed avc (davc) circuit.

$R_1$  is the diode load resistor and  $R_2$  and  $C_2$  are the avc filter. Because the cathode of diode  $D_2$  is returned through a fixed supply of  $-3$  volts to the cathode of  $D_1$ , a dc current flows through  $R_1$  and  $R_2$  in series with  $D_1$ . The voltage drop caused by this current places the avc lead at approximately  $-3$  volts (less the negligible drop through  $D_1$ ). When the average amplitude of the rectified signal developed across  $R_1$  does not exceed 3 volts, the avc lead remains at  $-3$  volts. Hence, for signals not strong enough to develop 3 volts across  $R_1$ , the bias applied to the controlled tubes stays constant at a value giving high sensitivity.

However, when the average amplitude of rectified signal voltage across  $R_1$  exceeds 3 volts, the plate of diode  $D_1$  becomes more negative than the cathode of  $D_1$ , and current flow in diode  $D_1$  ceases. The potential of the avc lead is then controlled by the voltage developed across  $R_1$ . Therefore, with further increase in signal strength, the avc circuit applies an increasing avc



bias voltage to the controlled stages. In this way, the circuit regulates the receiver gain for strong signals, but permits the gain to stay constant at a maximum value for weak signals.

It can be seen in Fig. 62 that a portion of the  $-3$  volts delay voltage is applied to the plate of the detector diode  $D_1$ , this portion being approximately equal to  $R_1/(R_1 + R_2)$  times  $-3$  volts. Hence, with the circuit constants as shown, the detector plate is made negative with respect to its cathode by approximately one-half volt. However, this voltage does not interfere with detection because it is not large enough to prevent current flow in the tube.

**Automatic gain control (agc)** compensates for fluctuations in rf picture carrier amplitude. The peak carrier level rather than the average carrier level is controlled by the agc voltage because the peaks of the sync pulses are fixed when inserted on a fixed carrier level. The peak carrier level may be determined by measurement of the peaks of the sync pulses at the output of the video detector.

A conventional agc circuit, such as that shown in Fig. 63, consists of a diode

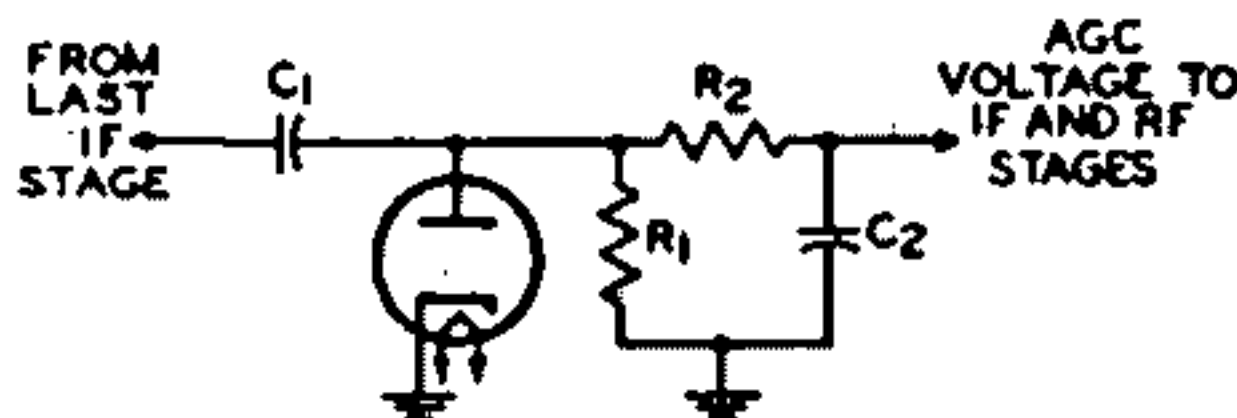


Fig. 63—Automatic-gain control (agc) circuit.

detector circuit and an RC filter. The time constant of the detector circuit is made large enough to prevent the picture content from influencing the magnitude of the agc voltage. The output voltage (agc voltage) is equal to the peak value of the incoming signal.

The diode detector receives the incoming signal from the last if stage of the television receiver through the capacitor  $C_1$ . The resistor  $R_1$  provides the load for the diode. The diode conducts only when its plate is driven positive with respect to its cathode. Electrons then flow from the cathode to the plate and thence into capacitor  $C_1$ , where the negative charge is stored. Because of the

low impedance offered by the diode during conduction,  $C_1$  charges up to the value of the peak applied voltage.

During the negative excursion of the signal, the diode does not conduct, and  $C_1$  discharges through resistor  $R_1$ . Because of the large time constant of  $R_1C_1$ , however, only a small percentage of the voltage across  $C_1$  is lost during the interval between horizontal sync pulses. During succeeding positive cycles, the incoming signal must overcome the negative charge stored in  $C_1$  before the diode conducts, and plate current flows only at the peak of each positive cycle. The voltage across  $C_1$ , therefore, is determined by the level of the peaks of the positive cycles or the sync pulses.

The negative voltage developed across resistor  $R_1$  by the sync pulses is filtered by resistor  $R_2$  and capacitor  $C_2$  to remove the 15,750-cycle ripple of the horizontal sync pulse. The dc output is then fed to the if and rf amplifiers as an agc voltage.

This agc system may be expanded to include amplification of the agc signal before detection of the peak level, or amplification of the dc output, or both. A direct-coupled amplifier must be used for amplification of the dc signal. The addition of amplification makes the system more sensitive to changes in carrier level.

A "keyed" agc system such as that shown in Fig. 64 is used to eliminate flutter and to improve noise immunity in weak signal areas. This system provides more rapid action than the conventional agc circuits because the filter circuit can employ lower capacitance and resistance values.

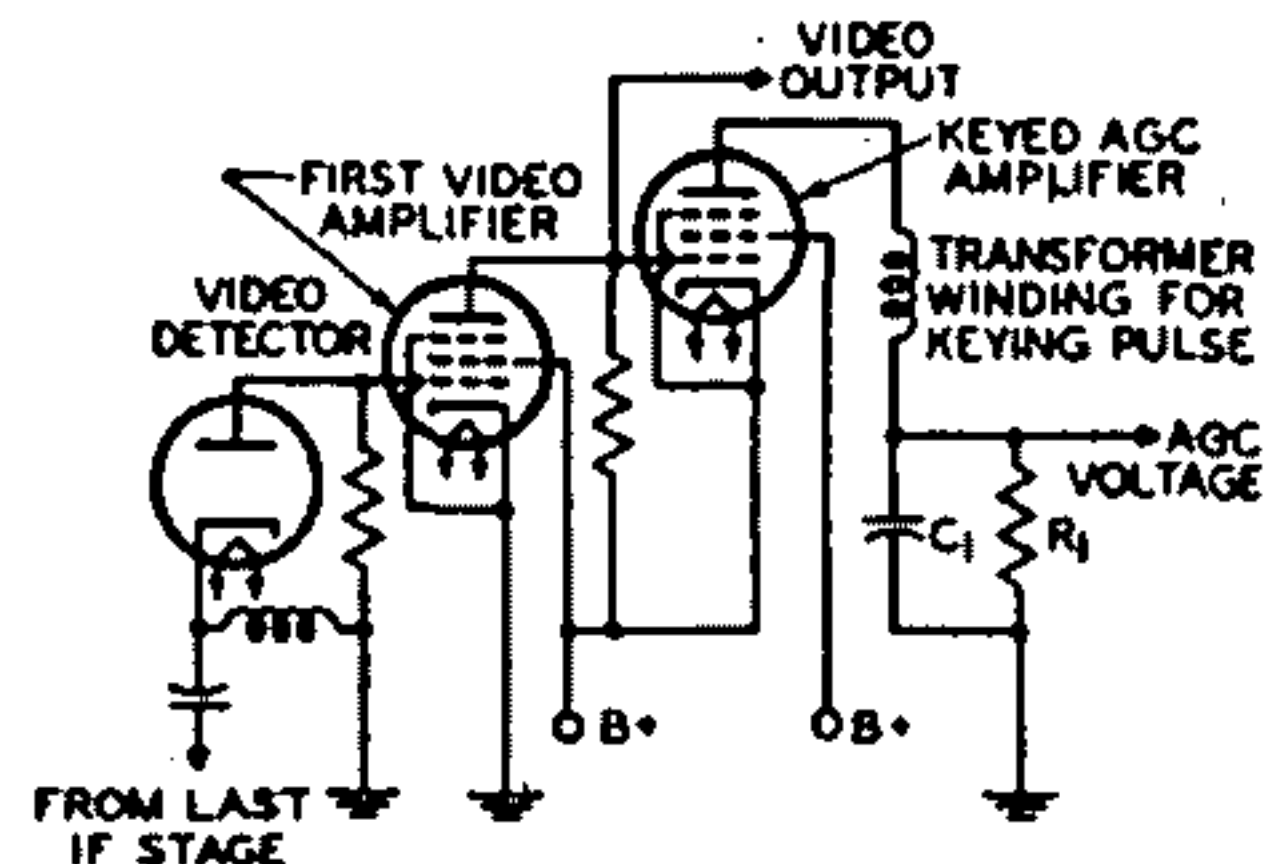


Fig. 64—"Keyed" agc circuit.

In the keyed agc system, the negative output of the video detector is fed directly to the grid No. 1 of the first video amplifier. The positive output of the video amplifier is, in turn, fed directly to the grid No. 1 of the keyed agc amplifier. The video stage increases the gain of the agc system and, in addition, provides noise clipping. The plate voltage for the agc amplifier is a positive pulse obtained from a small winding on the horizontal output transformer which is in phase with the horizontal sync pulse obtained from the video amplifier. The polarity of this pulse is such that the plate of the agc amplifier tube is positive during the retrace time. The tube is biased so that current flows only when the grid No. 1 and the plate are driven positive simultaneously. The amount of current flow depends on the grid-No. 1 potential during the pulse. These pulses are smoothed out in the RC network in the plate circuit ( $R_1C_1$ ). Because the dc voltage developed across  $R_1$  is negative, it is suitable for application to the grids of the rf and if tubes as an agc voltage.

### *High-Fidelity Amplifiers*

Several high-fidelity amplifiers are shown in the **Circuits** section. The performance capabilities of such amplifiers are usually given in terms of frequency response, total harmonic distortion, maximum power output, and noise level.

To provide high-fidelity reproduction of audio program material, an amplifier should have a frequency response which does not vary more than 1 db over the entire audio spectrum. General practice is to design the amplifier so that its frequency response is flat within 1 dB from a frequency below the lowest to be reproduced to one well above the upper limit of the audible region.

Harmonic distortion and intermodulation distortion produce changes in program material which may have adverse effects on the quality of the reproduced sound. **Harmonic distortion** causes a change in the character of an individual tone by the introduction of harmonics which were not originally present in the program material. For

high-fidelity reproduction, total harmonic distortion (expressed as a percentage of the output power) should not be greater than about 1 per cent at the desired listening level. Types such as the 6973, 7027A and 7868 are designed to provide extremely low harmonic distortion in suitably designed push-pull amplifier circuits.

**Intermodulation distortion** is a change in the waveform of an individual tone as a result of interaction with another tone present at the same time in the program material. This type of distortion not only alters the character of the modulated tone, but may also result in the generation of spurious signals at frequencies equal to the sum and difference of the interacting frequencies. Intermodulation distortion should be less than 2 per cent at the desired listening level. In general, any amplifier which has low intermodulation distortion will have very low harmonic distortion.

The maximum power output which a high-fidelity amplifier should deliver depends upon a complex relation of several factors, including the size and acoustical characteristics of the listening area, the desired listening level, and the efficiency of the loudspeaker system. Practically, however, it is possible to determine amplifier requirements in terms of room size and loudspeaker efficiency.

The acoustic power required to reproduce the loudest passages of orchestral music at concert-hall level in the average-size living room is about 0.4 watt. Because high-fidelity loudspeakers of the type generally available for home use have an efficiency of only about 5 per cent, the output stage of the amplifier should therefore be able to deliver a power output of at least 8 watts. Because many wide-range loudspeaker systems, particularly those using frequency-divider networks, have efficiencies of less than 5 per cent, output tubes used with such systems must have correspondingly larger power outputs. The 6973, 7027A, 7189, and 7868 can provide ample output for most systems when used in suitable push-pull circuits.

The noise level of a high-fidelity



amplifier determines the range of volume the amplifier is able to reproduce, *i.e.*, the difference (usually expressed in decibels) between the loudest and softest sounds in program material. Because the greatest volume range utilized in electrical program material at the present time is about 60 dB, the noise level of a high-fidelity amplifier should be at least 60 dB below the signal level at the desired listening level.

### *Limiters*

An amplifier may also be used as a limiter. One use of a limiter is in receivers designed for the reception of frequency-modulated signals. The limiter in FM receivers has the function of eliminating amplitude variations from the input to the detector. Because in an FM system amplitude variations are primarily the result of noise disturbances, the use of a limiter prevents such disturbances from being reproduced in the audio output. The limiter usually follows the last if stage so that it can minimize the effects of disturbances coming in on the rf carrier and those produced locally.

The limiter is essentially an if voltage amplifier designed for saturated operation. Saturated operation means that an increase in signal voltage above a certain value produces very little increase in plate current. A signal voltage which is never less than sufficient to cause saturation of the limiter, even on weak signals, is supplied to the limiter input by the preceding stages. Any change in amplitude, therefore, such as might be produced by noise voltage fluctuation, is not reproduced in the limiter output. The limiting action, of course, does not interfere with the reproduction of frequency variations.

Plate-current saturation of the limiter may be obtained by the use of grid-No. 1 resistor-and-capacitor bias with plate and grid-No. 2 voltages which are low compared with customary if-amplifier operating conditions.

As a result of these design features, the limiter is able to maintain its output voltage at a constant amplitude over a wide range of input-signal voltage variations. The output of the limiter is frequency-modulated if voltage, the mean

frequency of which is that of the if amplifier. This voltage is impressed on the input of the detector.

The reception of FM signals without serious distortion requires that the response of the receiver be such that satisfactory amplification of the signal is provided over the entire range of frequency deviation from the mean frequency. Since the frequency at any instant depends on the modulation at that instant, it follows that excessive attenuation toward the edges of the band, in the rf or if stages, will cause distortion. In a high-fidelity receiver, therefore, the amplifiers must be capable of amplifying, for the maximum permissible frequency deviation of 75 kHz, a band 150 kHz wide. Suitable tubes for this purpose are the 6BA6 and 6BJ6.

### *Volume Compressors and Expanders*

Volume compression and expansion are used in FM transmitters and receivers and in recording devices and amplifiers to make more natural the reproduction of music which has a very large volume range. For example, in the music of a symphony orchestra the sound intensity of the soft passages is very much lower than that of the loud passages. When this low volume level is raised above the background noise for transmitting or recording, the peak level of the program material may be raised to an excessively high volume level. It is often necessary, therefore, to compress the volume range of the program content within the maximum capabilities of the FM transmitter or the recording device. Exceeding a maximum peak volume level for FM modulation corresponds to exceeding the allowed bandwidth for transmission. In some recording devices, excessive peak volume levels may cause overloading and distortion.

Volume compression may be accomplished by either manual or automatic control. The types of compression used include peak limiters, volume limiters, and volume compressors. A peak limiter limits the peak power to some predetermined level. A volume limiter provides gain reduction based on an

average signal level above a predetermined level. A volume compressor provides gain reduction for only the sustained loud portions of the sound level. Only volume compressors can be correctly compensated for with volume expanders.

For faithful reproduction of the original sound, the volume expander used in the FM receiver or audio amplifier should have the reverse characteristic of the volume compressor used in the FM transmitter or recording device. In general, the basic requirements for either a volume compressor or expander are shown in the block diagram of Fig. 65. In a volume compressor, the

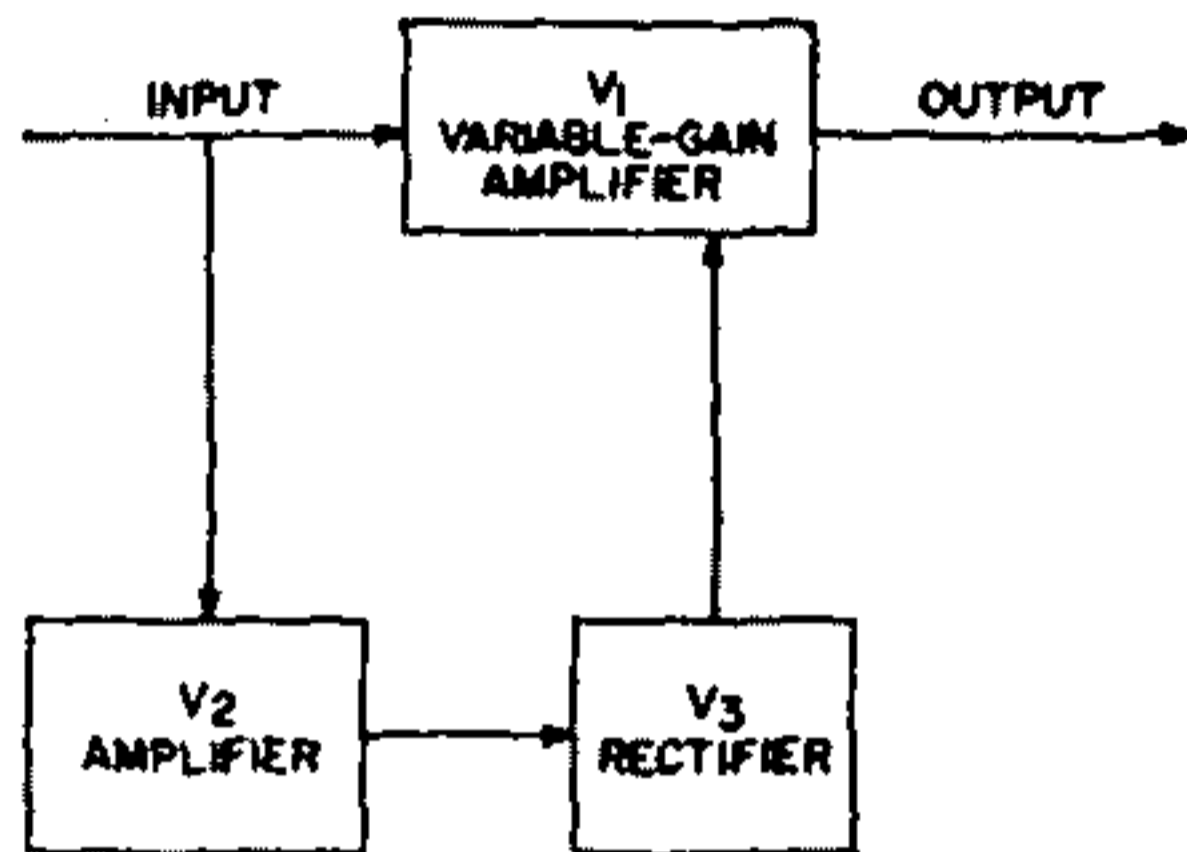


Fig. 65—Block diagram of volume compressor or expander circuit.

variable-gain amplifier  $V_1$  has greater gain for a low-amplitude signal than for a high-amplitude signal; therefore, soft passages are amplified more than loud ones. In an expander, the gain is greater for high-amplitude signals than for low-amplitude signals; therefore, loud passages are amplified more than soft ones and the original amplitude ratio is restored.

In the diagram shown in Fig. 65, the signal to be amplified is applied to  $V_1$ , and a portion of the signal is also applied to  $V_2$ . The amplified output from  $V_2$  is then rectified by  $V_3$ , and applied as a negative (for compressors) or positive (for expanders) bias voltage to  $V_1$ . As this bias voltage varies with variations in signal amplitude, the gain of  $V_1$  also varies to produce the desired compression or expansion of the signal.

Tubes having a large dynamic range provide the best results in volume

compressor or expander applications. Examples of such types are the 6BJ6 and 6BE6. Push-pull operation is generally desired for the variable-gain amplifier to prevent high distortion and other undesirable effects which may occur in volume compressors and expanders.

### Phase Inverters

A phase inverter is a circuit used to provide resistance coupling between the output of a single-tube stage and the input of a push-pull stage. The necessity for a phase inverter arises because the signal-voltage inputs to the grids of a push-pull stage must be 180 degrees out of phase and approximately equal in amplitude with respect to each other. Thus, when the signal voltage input to a push-pull stage swings the grid of one tube in a positive direction, it should swing the grid of the other tube in a negative direction by a similar amount. With transformer coupling between stages, the out-of-phase input voltage to the push-pull stage is supplied by means of the center-tapped secondary. With resistance coupling, the out-of-phase input voltage is obtained by means of the inverter action of a tube.

Fig. 66 shows a push-pull power amplifier, resistance-coupled by means of a phase-inverter circuit to a single-stage triode  $T_1$ . Phase inversion in this circuit is provided by triode  $T_2$ . The output voltage of  $T_1$  is applied to the grid No. 1 of tetrode  $T_3$ . A portion of the output voltage of  $T_1$  is also applied through the resistors  $R_3$  and  $R_4$  to the

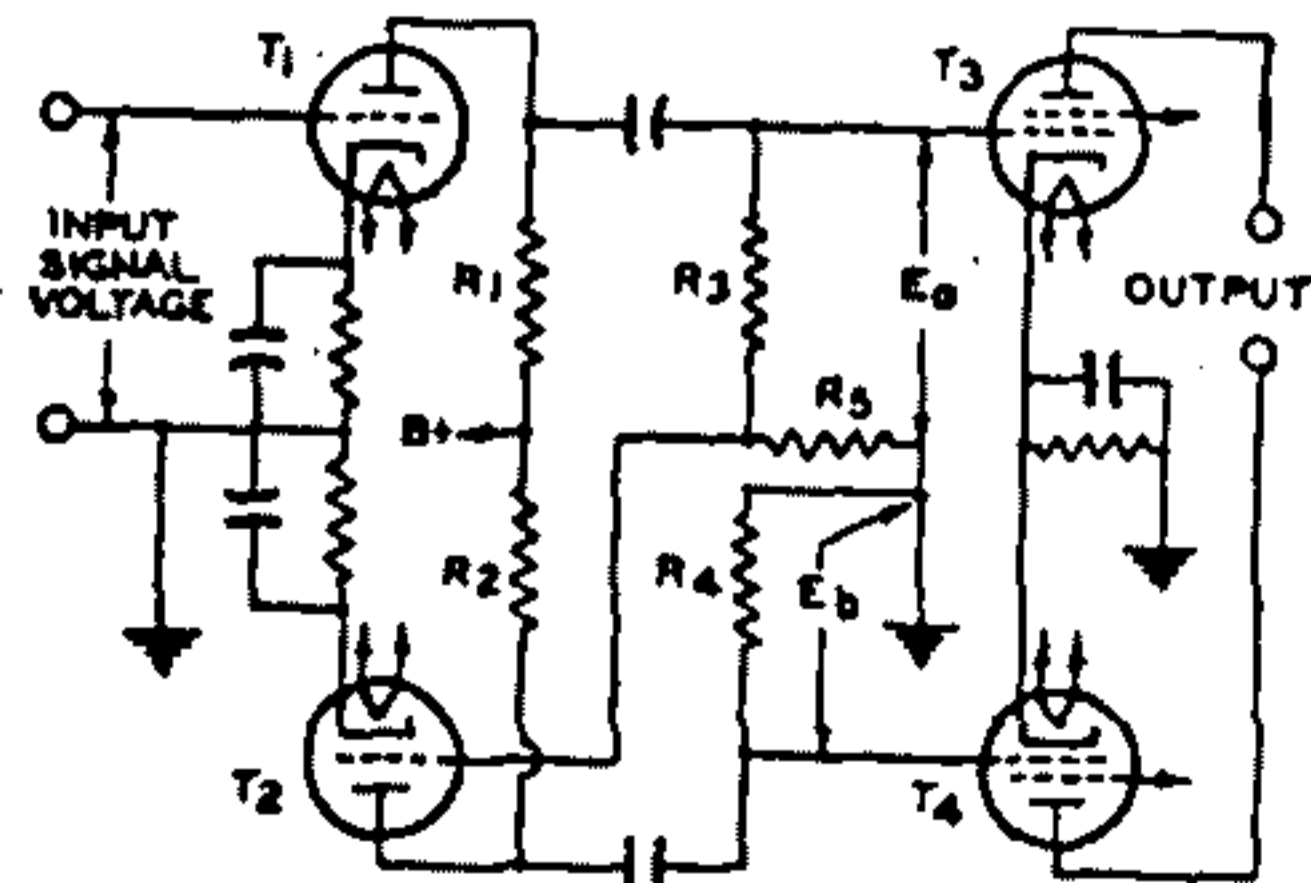


Fig. 66—Push-pull power amplifier resistance-coupled to triode by means of phase inverter.



grid of  $T_2$ . The output voltage of  $T_2$  is applied to the grid No. 1 of tetrode  $T_1$ .

When the output voltage of  $T_1$  swings in the positive direction, the plate current of  $T_2$  increases. This action increases the voltage drop across the plate resistor  $R_2$  and swings the plate of  $T_2$  in the negative direction. Thus, when the output voltage of  $T_1$  swings positive, the output voltage of  $T_2$  swings negative and is, therefore, 180 degrees out of phase with the output voltage of  $T_1$ .

In order to obtain equal voltages at  $E_a$  and  $E_b$ ,  $(R_1 + R_2)/R_2$  should equal the voltage gain of  $T_2$ . Under the condition where a twin-type tube or two tubes having the same characteristics are used as  $T_1$  and  $T_2$ ,  $R_1$  should be equal to the sum of  $R_2$  and  $R_3$ . The ratio of  $R_1 + R_2$  to  $R_2$  should be the same as the voltage gain ratio of  $T_2$  in order to apply the correct value of signal voltage to  $T_2$ . The value of  $R_1$  is, therefore, equal to  $R_2$  divided by the voltage gain of  $T_2$ ;  $R_3$  is equal to  $R_1$  minus  $R_2$ . Values of  $R_1$ ,  $R_2$ ,  $R_3$  plus  $R_2$ , and  $R_1$  may be taken from the chart in the **Resistance-Coupled Amplifiers** section. In the practical application of this circuit, it is convenient to use a twin-triode tube combining  $T_1$  and  $T_2$ .

### Tuned Amplifiers

In radio-frequency (rf) and intermediate-frequency (if) amplifiers, the bandwidth of frequencies to be amplified is usually only a small percentage of the center frequency. Tuned amplifiers are used in these applications to select the desired bandwidth of frequencies and to suppress unwanted frequencies. The selectivity of the amplifier is obtained by means of tuned interstage coupling networks.

The properties of tuned amplifiers depend upon the characteristics of resonant circuits. A simple parallel resonant circuit (sometimes called a "tank" because it stores energy) is shown in Fig. 67. For practical purposes the resonant frequency of such a circuit may be considered independent of the resistance  $R$ , provided  $R$  is small compared to the inductive reactance  $X_L$ .

The resonant frequency  $f_r$  is then given by

$$f_r = \frac{1}{2\pi\sqrt{LC}}$$

For any given resonant frequency, the product of  $L$  and  $C$  is a constant; at low frequencies  $LC$  is large; at high frequencies it is small.

The  $Q$  (selectivity) of a parallel resonant circuit alone is the ratio of the current in the tank ( $I_L$  or  $I_C$ ) to the current in the line ( $I$ ). This unloaded  $Q$ , or  $Q_0$ , may be expressed in various ways, for example:

$$Q_L = \frac{I_0}{I} = \frac{X_L}{R} = \frac{R_p}{X_C}$$

where  $X_L$  is the inductive reactance ( $= 2\pi fL$ ),  $X_C$  is the capacitive reactance ( $= 1/[2\pi fC]$ ), and  $R_p$  is the total impedance of the parallel resonant circuit

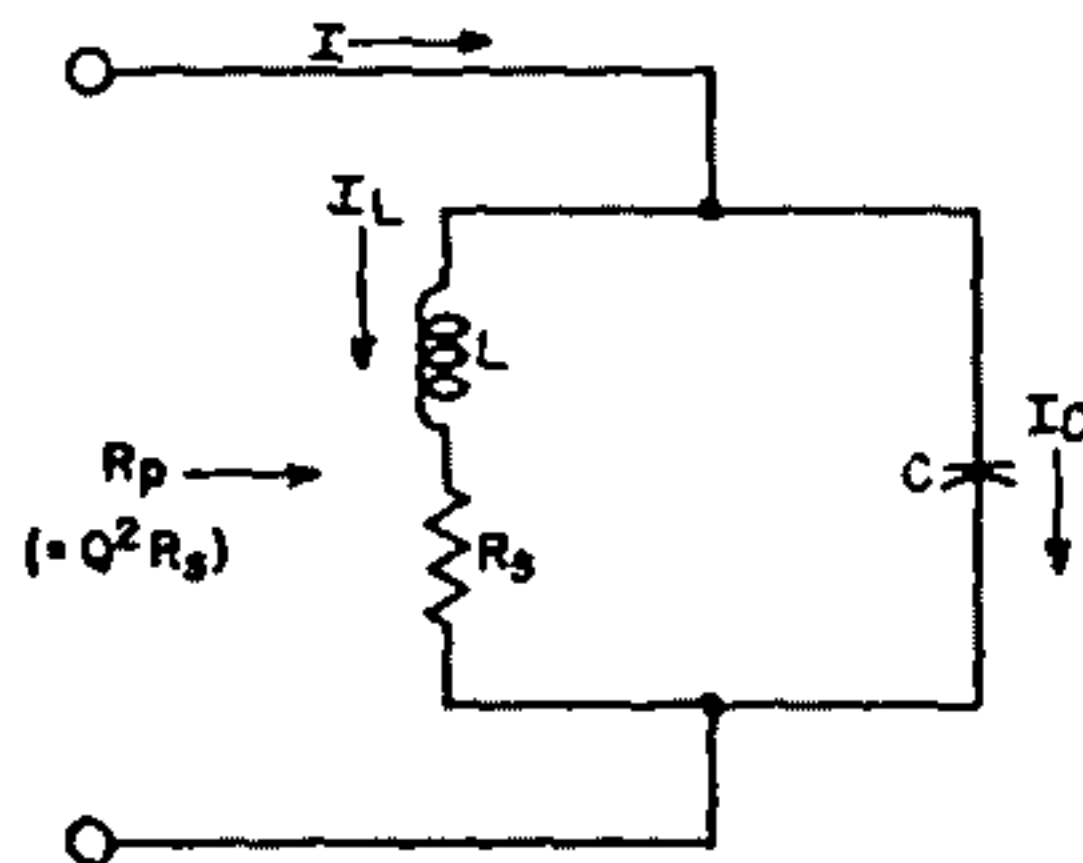


Fig. 67—Simple parallel resonant circuit. (tank) at resonance. The  $Q$  varies inversely with the resistance of the inductor. The lower the resistance, the higher the  $Q$  and the greater the difference between the tank impedance at frequencies off resonance compared to the tank impedance at the resonant frequency.

The  $Q$  of a tuned interstage coupling network also depends upon the impedances of the preceding and following stages. The output impedance of a tube can be considered as consisting of a resistance  $R_o$  in parallel with a capacitance  $C_o$ , as shown in Fig. 68. Similarly, the input impedance can be considered as consisting of a resistance  $R_i$  in parallel with a capacitance  $C_i$ . Because the tuned circuit is shunted by both the output impedance of the preceding tube and the input impedance of the following tube, the effective selectivity of the circuit is the loaded  $Q$  (or

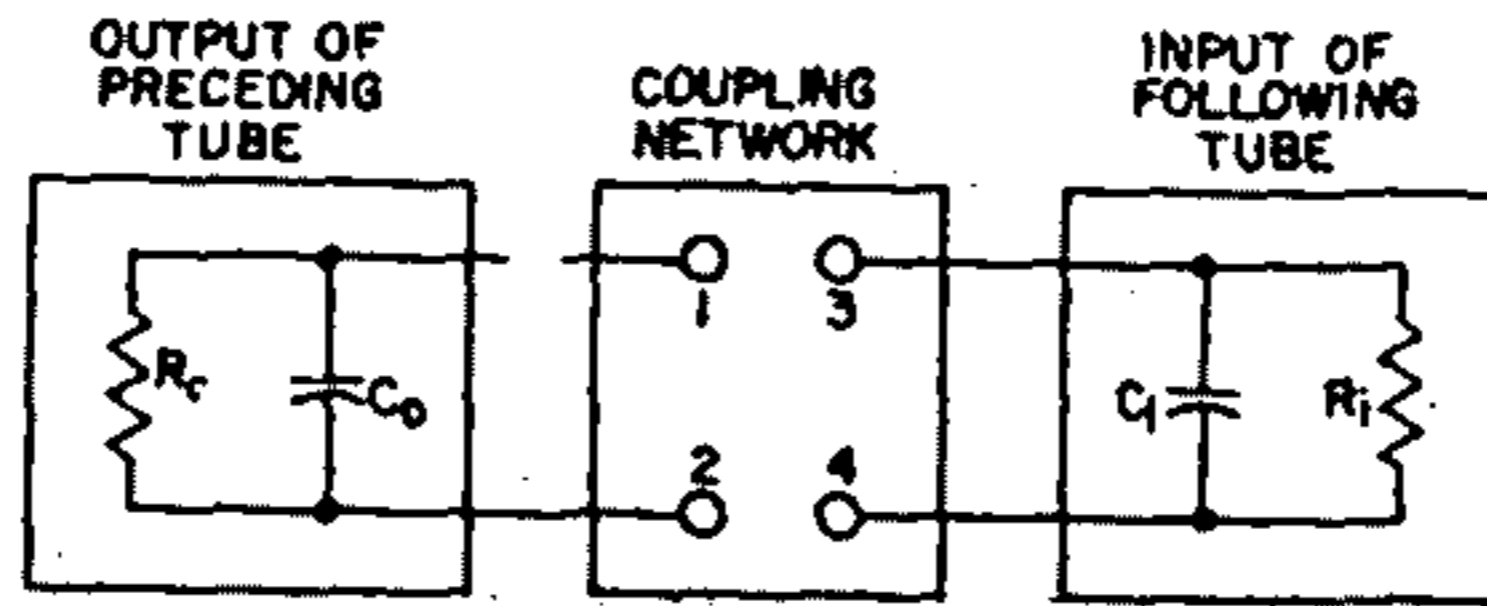


Fig. 68—Equivalent output and input circuits of tubes connected by a coupling network.

$Q_L$ ) based upon the total impedance of the coupled network, as follows:

$$Q_L = \frac{\text{total loading on coil at resonance}}{X_L \text{ or } X_o}$$

The capacitances  $C_o$  and  $C_i$  in Fig. 68 are usually considered as part of the coupling network. For example, if the required capacitance between terminals 1 and 2 of the coupling network is calculated to be 500 picofarads and the value of  $C_o$  is 10 picofarads, a capacitor of 490 picofarads is used between terminals 1 and 2 so that the total capacitance is 500 picofarads. The same method is used to allow for the capacitance  $C_i$  at terminals 3 and 4.

When a tuned resonant circuit in the primary winding of a transformer is coupled to the nonresonant secondary winding of the transformer, as shown in Fig. 69, the effect of the input impedance of the following stage on the  $Q$  of the tuned circuit can be determined by considering the values reflected (or referred) to the primary circuit by

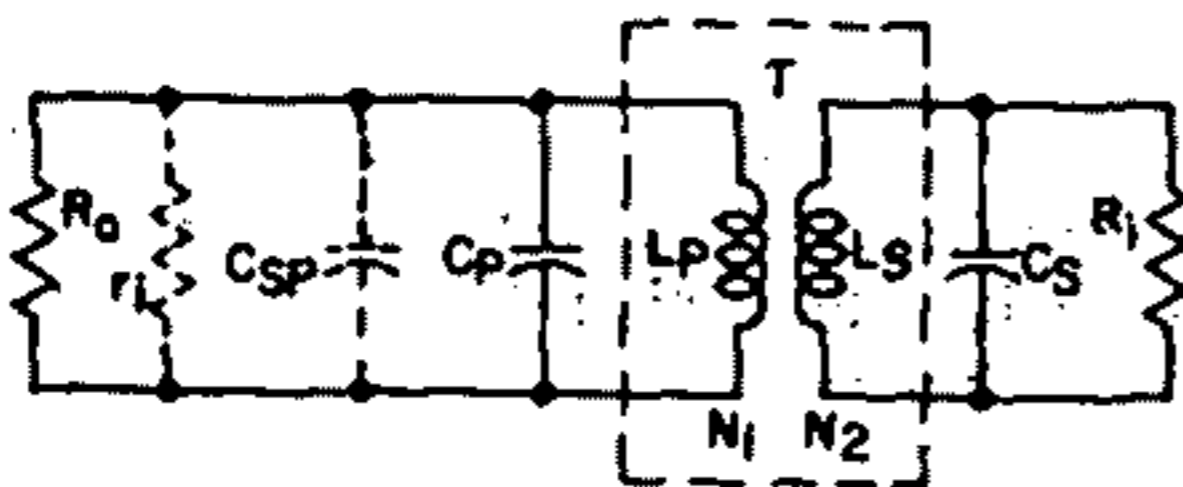


Fig. 69—Equivalent circuit for transformer-coupling network having tuned primary winding.

transformer action. The reflected resistance  $r_1$  is equal to the resistance  $R_i$  in the secondary circuit times the square of the effective turns ratio between the primary and secondary windings of the transformer  $T$ :

$$r_1 = R_i (N_1/N_2)^2$$

where  $N_1/N_2$  represents the electrical turns ratio between the primary winding

and the secondary winding of  $T$ . If there is capacitance in the secondary circuit ( $C_s$ ), it is reflected to the primary circuit as a capacitance  $C_{sp}$ , and is given by

$$C_{sp} = C_s + (N_1/N_2)^2$$

The loaded  $Q$ , or  $Q_L$ , is then calculated on the basis of the inductance  $L_p$ , the total shunt resistance ( $R_o$  plus  $r_1$  plus the tuned-circuit impedance  $Z_t = Q_o X_o = Q_o X_L$ ), and the total capacitance ( $C_p + C_{sp}$ ) in the tuned circuit.

Fig. 70 shows a coupling network which consists of a single-tuned circuit using mutual inductive coupling. The

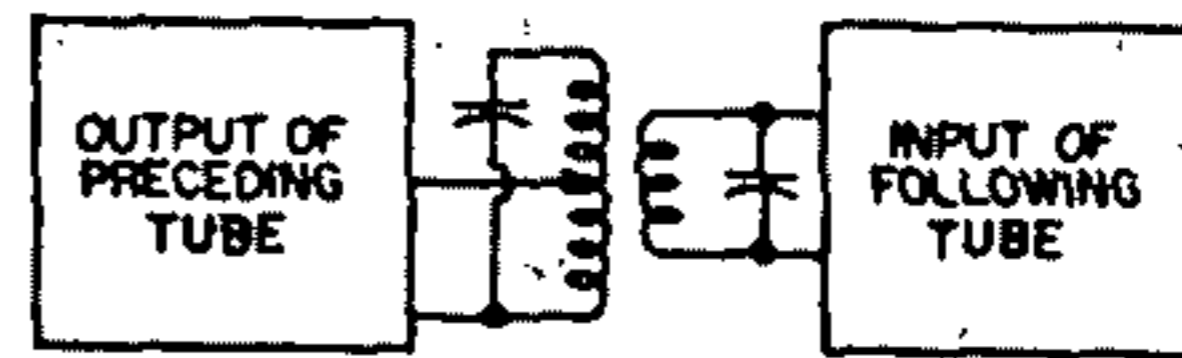


Fig. 70—Equivalent circuit for transformer-coupling network using inductive coupling.

capacitance  $C_t$  includes the effects of both the output capacitance of the preceding tube and the input capacitance of the following tube (referred to the primary of transformer  $T_1$ ). The bandwidth of a single-tuned transformer is determined by the half-power points on the resonance curve ( $-3$  dB or 0.707 down from the maximum). Under these conditions, the band pass  $\Delta f$  is equal to the ratio of the center or resonant frequency  $f_r$  divided by the loaded (effective)  $Q$  of the circuit, as follows:

$$\Delta f = f_r/Q_L$$

In high-frequency tuned amplifiers, where the input impedance is typically low, mutual inductive coupling may be impracticable because of the small number of turns in the secondary winding. It is extremely difficult in practice to construct a fractional part of a turn. In such cases, capacitance coupling may



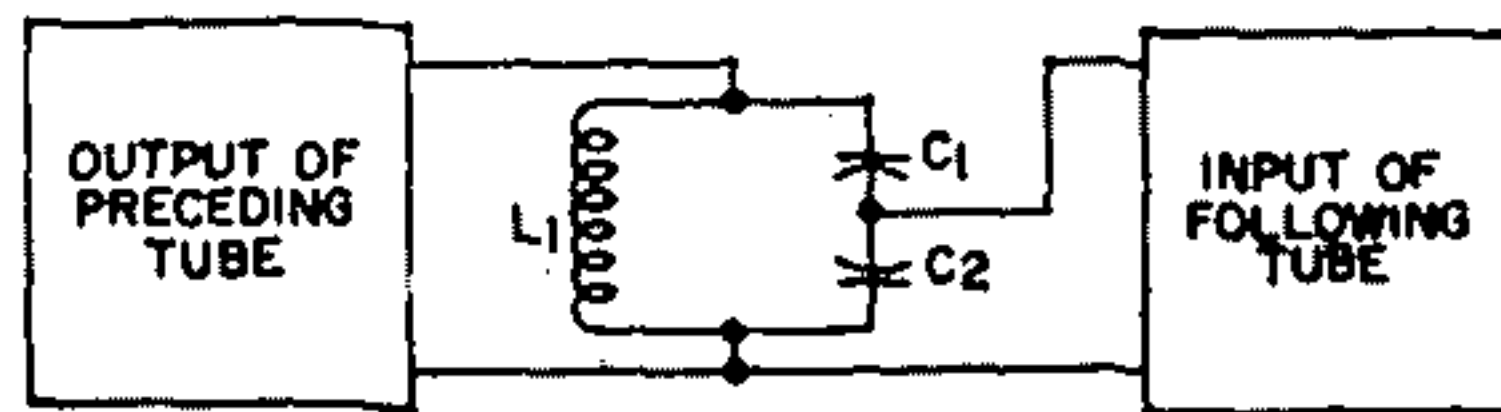


Fig. 71—Single-tuned coupling network using capacitive division.

be used, as shown in Fig. 71. This arrangement, which is also called **capacitive division**, is similar to tapping down on a coil at or near resonance. Impedance transformation in this network is determined by the ratio between capacitors  $C_1$  and  $C_2$ . Capacitor  $C_1$  is normally much smaller than  $C_2$ ; thus the capacitive reactance  $X_{C1}$  is normally much larger than  $X_{C2}$ . Provided the input resistance of the following tube is much greater than  $X_{C2}$ , the effective turns ratio from the top of the coil to the input of the following tube is  $(C_1 + C_2)/C_1$ . The total capacitance  $C_t$  across the inductance  $L$  is given by

$$C_t = \frac{C_1 C_2}{C_1 + C_2}$$

The resonant frequency  $f_r$  is then given by

$$f_r = \frac{1}{2\pi\sqrt{L C_t}}$$

Double-tuned interstage coupling networks are often used in preference to single-tuned networks to provide flatter frequency response within the pass band, a sharper drop in response immediately adjacent to the ends of the pass band, or more attenuation at frequencies far removed from resonance. In synchronous double-tuned networks, both the resonant circuit in the input of the coupling network and the resonant circuit in the output are tuned to the same resonant frequency. In "stagger-tuned" networks, the two resonant circuits are tuned to slightly different resonant frequencies to provide a more rectangular band pass with sharper selectivity at the ends of the pass band. Double-tuned or stagger-tuned networks may use capacitive, inductive, or mutual inductance coupling, or any combination of the three.

#### Television Tuners

The vhf tuner of a television receiver selects the desired frequency

channel in the range from 55 to 216 MHz, amplifies it, and converts it to a lower intermediate frequency. These functions are accomplished in rf-amplifier, mixer, and local-oscillator stages employing tube types that are designed specifically for these applications. The rf-amplifier stage uses a high-transconductance tube that has small dimensions to maintain low interelectrode capacitances, particularly between grid and plate. The mixer and oscillator stages usually employ a dual-unit triode-pentode unit and a medium-mu triode unit.

Fig. 72 shows a simplified schematic diagram of a typical vhf television tuner. The balun converts the 300-ohm balanced antenna impedance to an unbalanced impedance of 75 ohms. The high-pass filter eliminates lower-frequency interference signals. The tuner is set to the desired frequency by simultaneous adjustment of the inductances indicated by the several sets of arrows in Fig. 72. The inductances are either replaced completely or incremental amounts of inductance are added as the tuner is switched from high frequencies to lower frequencies. Some tuners use a combination of the two methods.

Because noise generated in the first amplifier stage is often the controlling factor in determining the over-all sensitivity of a radio or television receiver, the "front end" is designed with special attention to both gain and noise characteristics. The input circuit of an amplifier inherently contains some thermal noise contributed by the resistive elements in the input device. When an input signal is amplified, therefore, the thermal noise generated in the input circuit is also amplified. If the ratio of signal power to noise power (signal-to-noise ratio, S/N) is the same in the output circuit as in the input circuit, the amplifier is considered to be "noise-

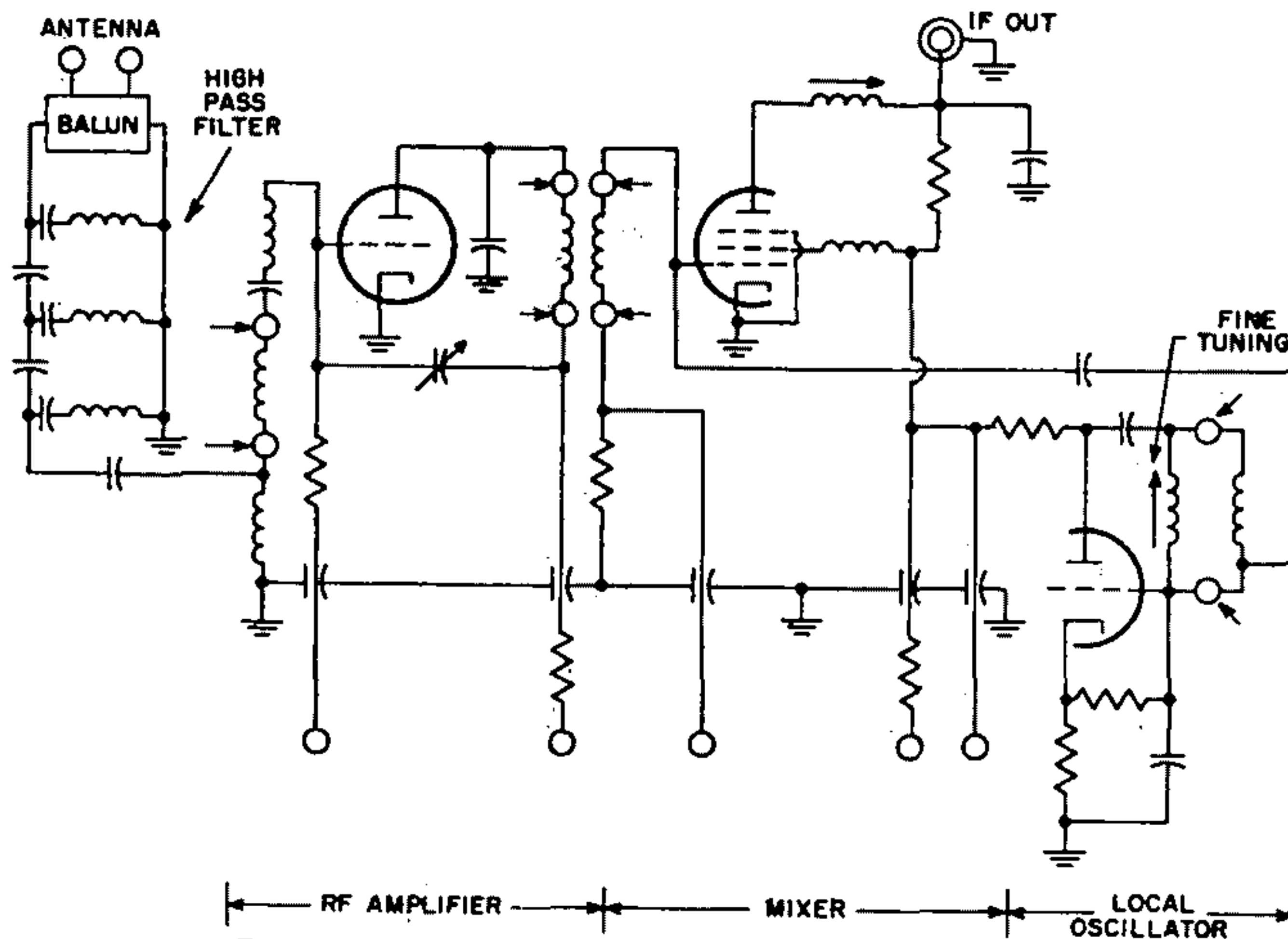


Fig. 72—Simplified schematic of typical vhf television tuner.

less," and is said to have a noise figure of unity, or zero dB.

In practical circuits, however, all amplifier stages generate a certain amount of noise as a result of thermal agitation of electrons in resistors and other components, minute variations in the cathode emission of tubes (shot effect), and minute grid currents in the amplifier tubes. As a result, the ratio of signal power to noise power is inevitably impaired during amplification. A measure of the degree of impairment is called the noise figure (NF) of the amplifier, and is expressed as the ratio of signal power to noise power at the input ( $S_1/N_1$ ) divided by the ratio of signal power to noise power at the output ( $S_o/N_o$ ), as follows:

$$NF = \frac{(S_1/N_1)}{(S_o/N_o)}$$

The noise figure in decibels (dB) is equal to ten times the logarithm of this power ratio. For example, a one-dB noise figure in an amplifier decreases the signal-to-noise ratio by a factor of 1.26, a 3-dB noise figure by a factor of 2, a 10-dB noise figure by a factor

of 10, and a 20-dB noise figure by a factor of 100.

The over-all noise figure of a receiver is affected by the total number of stages, as shown by the following relationship:

$$NF_{\text{Receiver}} = NF_1 + \frac{(NF_2 + 1)}{G_1} + \frac{(NF_3 + 1)}{G_1 G_2} \dots$$

where  $G$  represents power gain and the subscripts indicate the number of each stage. This relationship indicates that the contribution of the second-stage noise factor to that of the over-all receiver is reduced by the gain of the first stage. Therefore, it is important that the rf amplifier have enough gain to make the effect of the second stage negligible. The third stage will then have even less effect. The maximum available power gain  $G$  of an rf stage is given by

$$G = \frac{\mu_m^2 R_{in} R_{out}}{4}$$

For maximum gain, therefore, the rf-amplifier tube should have high transconductance and high input and output impedances. At frequencies in the vhf



television band, the input resistance is small enough to affect the gain. As mentioned previously, the rf tube is designed to have low interelectrode capacitances, small interelectrode spacings, and low lead inductances (particularly the cathode lead).

The gain of the rf stage must be reduced as the incoming-signal amplitude changes to prevent overload distortion in the following stages. As the signal amplitude increases, an automatic-gain-control (agc) circuit biases the rf tube to decrease its gain. The rf tube usually employs a semiremote-cutoff grid to reduce cross-modulation distortion.

Either a triode or a pentode can be used in the rf-amplifier stage of tuner input circuits of vhf television receivers. Such stages are required to amplify signals ranging from 55 to 216 MHz and having a bandwidth of 4.5 MHz (the tuner is usually aligned for a bandwidth of 6 MHz to assure complete coverage of the band). In early rf tuners, pentodes rather than triodes were used because the grid-plate capacitance of triodes created stability problems. However, the use of twin triodes in direct-coupled cathode-drive circuits makes it possible to obtain stable operation along with the low-noise characteristics of triodes.

Pentodes or tetrodes do not provide the useful sensitivity of triodes because of the "partition noise" introduced by the screen grid. The direct-coupled cathode-drive circuit provides both the gain and the stability capabilities of the pentode, as well as the advantages of a low-noise triode input stage. Because the cathode-drive stage provides a low-impedance load to the grounded-cathode stage, the gain of the latter stage is very low and there is no necessity for neutralizing the grid-plate capacitance. An interstage impedance, usually an inductance in series with the plate of the first stage and the cathode of the second stage, is often used at higher frequencies to provide a degree of impedance matching between the units. The cathode-drive portion of the circuit is matched to the input net-

work and provides most of the stage gain. Because the feedback path of the cathode-drive circuit is the plate-cathode capacitance, which in most cases is very small, excellent isolation is provided between the antenna and the local oscillator.

Development of single triodes having low grid-plate capacitance, such as the 6BN4, has made possible the design of neutralized triode rf circuits. Tubes such as the 6GK5 and 6CW4 are specially designed to minimize grid-plate capacitance to permit easier neutralization of a grounded-cathode circuit over the wide frequency band. Bridge-neutralized rf-amplifier stages are widely used in television tuners; in this arrangement, a portion of the output signal is returned to the grid out of phase with the feedback signal from the grid-plate capacitance. This circuit provides excellent gain and noise performance with stable operation across the band.

The mixer stage of a vhf tuner usually employs a pentode tube, or the pentode unit of a triode-pentode tube. Although triodes such as the 6J6 were used as mixers in early receivers, they have been replaced by pentodes because the higher output impedance of a pentode provides a higher mixer gain than can be obtained with a triode.

The amplified signal from the rf stage in Fig. 72 is applied to the mixer grid along with a local-oscillator signal of much larger amplitude. The local-oscillator signal varies the mixer grid voltage from cutoff into the grid-current region. This signal develops a grid-resistor bias, called the **injection voltage**, which is a measure of the local-oscillator voltage. Because the transfer curve of the mixer tube is nonlinear, mixing action between the rf signal and the local-oscillator signal produces sum and difference frequencies. The output circuit of the mixer is tuned to the difference frequency (about 44 MHz) and rejects all other frequencies. This signal is then fed to the intermediate-frequency amplifier.

The mixer gain is a function of the amplitude of the local-oscillator

signal. The gain has a broad maximum over a range of injection voltages from  $-2.5$  to  $-5.0$  volts for conventional-grid mixers and slightly lower for frame-grid mixers. Good impedance matching between the rf-amplifier plate and the mixer grid, consistent with bandpass requirements, is important to achieve maximum signal power transfer. A slight amount of regeneration is provided by a small screen-grid inductance. This regeneration effectively increases the mixer-grid input impedance and thus improves power gain.

The local-oscillator stage shown in Fig. 72 is a Colpitts type in which the tuned circuit is located between the grid and plate and the feedback path is through the tube interelectrode capacitances. A large signal is developed in the local oscillator and coupled loosely to the mixer grid to minimize the effects of changes in the mixer input on the frequency of oscillation. The circuit is designed to keep frequency shift within a very narrow range with supply-voltage and temperature changes. Fine tuning is provided by a variable inductance or capacitance across the tuned circuit. Tubes commonly used in local-oscillator and mixer circuits are the 6EA8, 6KZ8, and 6KE8.

#### *Television IF Amplifiers*

The intermediate-frequency (if) amplifier stages in a television receiver provide the additional gain required to bring the signal level to an amplitude suitable for final detection. A constant peak signal of about three to five volts is required at the input to the detector. The mixer output signal is passed through two or three stages of amplification to attain this level. High-transconductance pentodes having low grid-No.1-to-plate capacitances are normally used in if amplifiers. The coupling circuits are usually tuned transformers which may be single- or double-tuned. The transformers are either synchronously (same frequency) tuned, or stagger-tuned, depending on circuit requirements. The over-all bandwidth varies from a maximum of 3.58 MHz at the 6-dB points for color receivers to

values in the order of 2.0 to 2.5 MHz for the most inexpensive receivers. An expression for the figure of merit for a single tuned if-amplifier tube is the gain-bandwidth product  $G \times B$ , which is given by

$$G \times B = \frac{\mu_m}{2\pi C}$$

where  $C$  is the total tuning capacitance. This relationship again demonstrates the need for high transconductance and low interelectrode capacitance.

The first stage (or first two stages in the case of a three-stage if) is gain-controlled like the rf amplifier. However, the bias applied to the if-amplifier tube varies the input resistance and capacitance of the tube and thus detunes the circuit. It is important for proper reception to maintain the frequency response of the if stages constant, particularly in the case of the color receiver. Therefore, a small unbypassed cathode resistor is used which provides degenerative feedback to minimize the effect of bias changes. In addition, the effects on input impedance caused by the grid-plate capacitance are reduced by use of a partial bypass capacitor at the screen grid to provide neutralization of the grid-to-plate capacitance.

Tubes used in the gain-controlled stages of the if amplifier have remote- or semiremote-cutoff characteristics to reduce cross-modulation or intermodulation interference. Tube types commonly used in this application include the 6BZ6, 6GM6, 6JH6, 6JD6A, and 6KT6.

The last if-amplifier stage is a relatively-large-signal amplifier. For this reason, the tube must be biased so that it will operate over a region of linear operation for large voltage excursions. Because such a quiescent operating point provides a transconductance somewhat below the maximum value for the tube, the selection of the operating point involves a compromise between signal-handling capacity and gain. For purposes of linearity, the final if-amplifier stage is not gain-controlled, and operates with the cathode bypassed to ground. Because fixed bias



is used, a sharp-cutoff tube is used to provide higher transconductance than could be obtained with an equivalent remote- or semiremote-cutoff tube. Examples of types used in this stage are the 6EW6 and 6JC6A.

#### Wideband (Video) Amplifiers

In some applications, it is necessary for a circuit to amplify signals ranging from very low frequencies (several hertz) to high frequencies (tens of megahertz) with a minimum of frequency and time-delay distortion. For example, very exacting requirements are demanded for such applications as television camera chains, ac voltmeters, and vertical amplifiers for oscilloscopes. In response to these demands, circuit compensation techniques have been developed to minimize the amplitude and time-delay variation as the upper or lower frequency limits of the amplifier are approached.

The need for such compensation is evident when many identical stages of amplification are employed. If ten cascaded stages are used, a variation of 0.3 dB per stage results in a total variation of 3 dB. In an uncompensated amplifier, this total variation occurs two octaves (a frequency ratio of four) prior to the half-power point. Because two octaves are lost from both the high and low frequencies, the bandwidth of ten cascaded uncompensated amplifier stages is only one-sixteenth that of a single amplifier stage. Fig. 73 shows the amplitude response characteristics of various numbers of identical

uncompensated amplifiers.

In general, the output of an amplifier may be represented by a current generator  $i_{out}$  and a load resistance  $R_L$ , as shown in Fig. 74(a). Because the signal current is shunted by various capacitances at high frequencies, as shown in Fig. 74(b), there is a loss in gain at these frequencies. If an inductor  $L$  is placed in series with the load resistor  $R_L$ , as shown in Fig. 74(c), a low-Q circuit is formed which somewhat suppresses the capacitive loading. This method of gain compensation, called **shunt peaking**, can be effective for improving high-frequency response. Fig. 74 shows the frequency response for the circuits in Fig. 74(a), (b), and (c). If the inductor  $L$  in Fig. 74(c) is made **self-resonant** approximately one octave above the 3-dB frequency of the circuit of Fig. 74(b), the amplifier response is extended by about another 30 per cent.

If the stray capacitance  $C$  shown in Fig. 74(b) is broken into two parts  $C'$  and  $C''$  and an inductor  $L$  is placed between them, a heavily damped form of series resonance may be employed for further improvement. This form of compensation, called **series peaking**, is shown in Fig. 75(a). If  $C'$  and  $C''$  are within a factor of two of each other, series peaking produces an appreciable improvement in frequency response as compared to shunt peaking. A more complex form of compensation embodying both self-resonant shunt peaking and series peaking is shown in Fig. 75(b).

The effects of various high-fre-

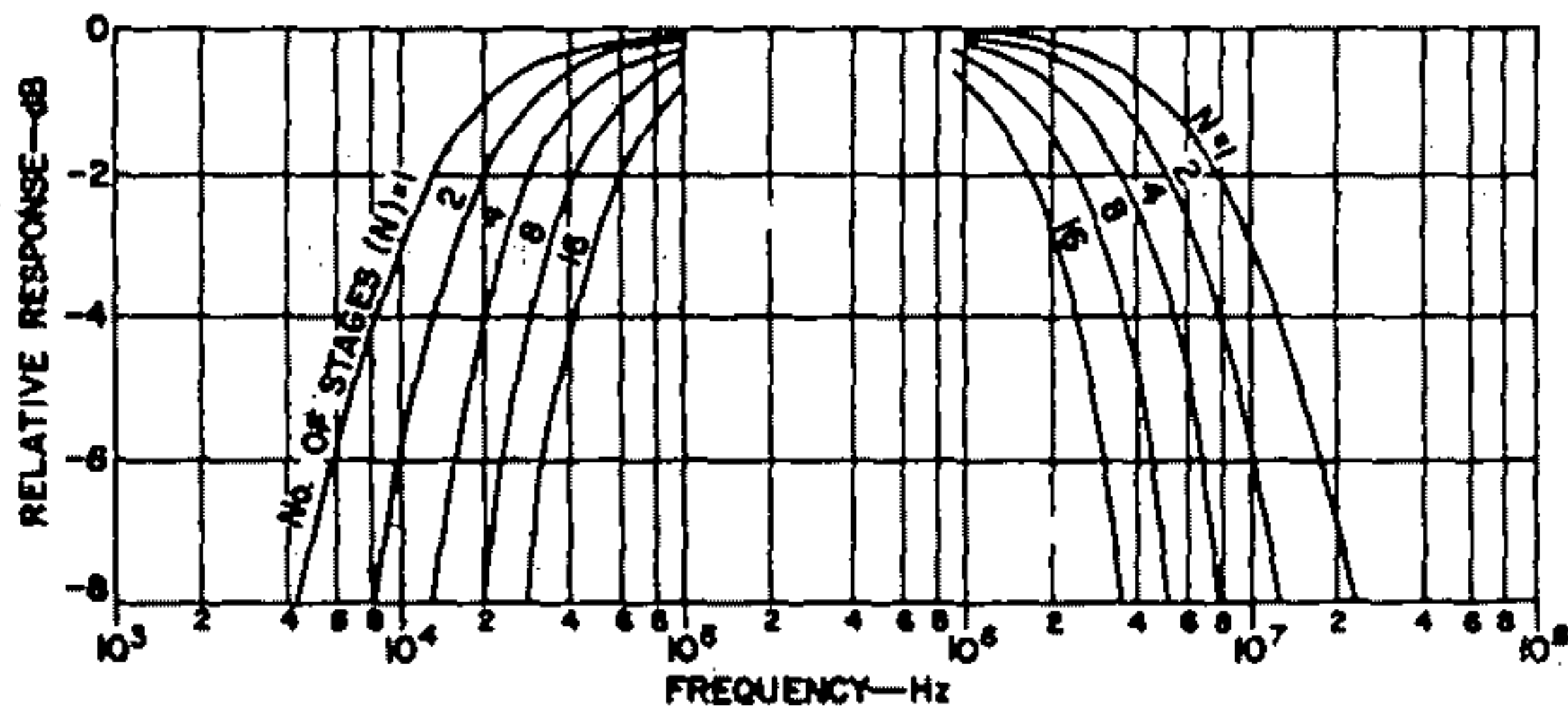


Fig. 73—Amplitude response characteristics of various numbers ( $N$ ) of identical uncompensated amplifiers.

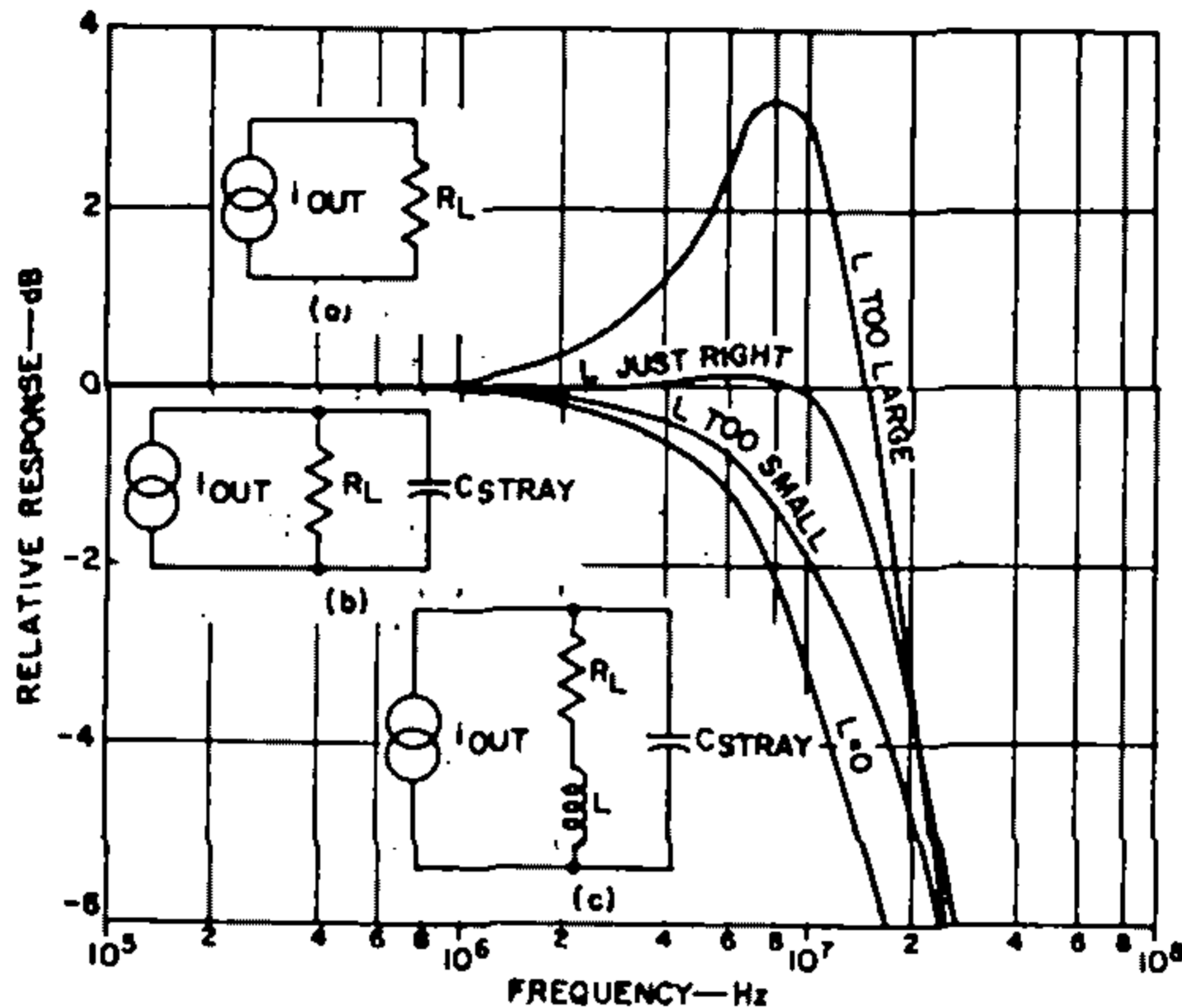


Fig. 74—Equivalent circuits and frequency response of uncompensated and shunt-peaked amplifiers.

quency compensation systems can be demonstrated by consideration of an amplifier consisting of three identical stages. If each of the three stages is down 3 dB at 1 MHz, and if a total gain variation of plus 1 dB and minus 3 dB is allowed, the bandwidth of the amplifier is 0.5 MHz without compensation. Shunt peaking raises the bandwidth to 1.3 MHz. Self-resonant shunt

width of approximately 2.8 MHz. If the capacitance is perfectly distributed, and if an infinitely complex network of shunt and series peaking is employed, the ultimate capability is about 4 MHz.

The frequency response of a wide-band amplifier is influenced greatly by variations in component values due to temperature effects, variation of tube parameters with voltage and current (normal large-signal excursions), changes of stray capacitance due to relocated lead wires, or other variations. A change of 20 per cent in any of the critical parameters can cause a change of 0.7 dB in gain per stage over the last half-octave of the response for the most simple case of shunt peaking. As the bandwidth is extended by more complex peaking, a circuit becomes substantially more critical. (Measurement probes generally alter circuit performance because of their capacitance; this effect should be considered during frequency-response measurements.)

In the design of wideband amplifiers using many stages of amplification, it is necessary to consider time-delay variations as well as amplitude variation. When feedback capacitance

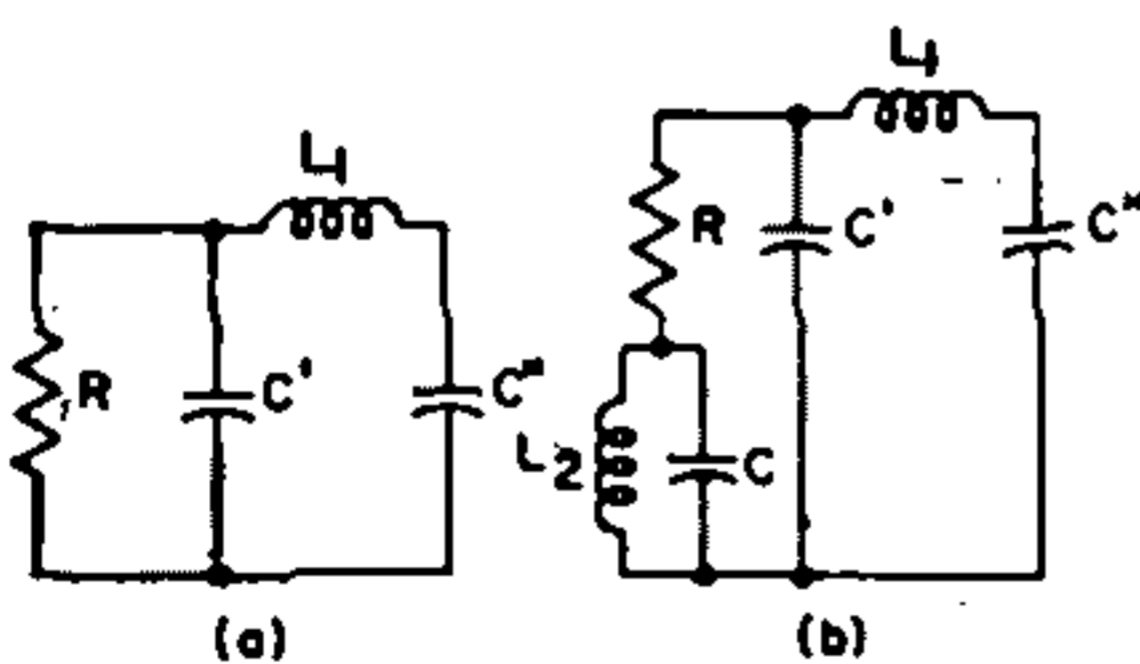


Fig. 75—Circuits using (a) series peaking, and (b) both self-resonant shunt peaking and series peaking.

peaking raises it to 1.5 MHz. An infinitely complicated network of shunt-peaking techniques could raise it to 2 MHz. If the distribution of capacitance permits it, series peaking alone can provide a bandwidth of about 2 MHz, while a combination of shunt and series peaking can provide a band-



is a major contributor to response limitation, the more complex compensating networks may produce severe ringing or even sustained oscillation. If feedback capacitance is treated as input capacitance produced by the Miller effect, the added input capacitance  $C_i'$  caused by the feedback capacitor  $C_f$  is given by

$$C_i' = C_f (1 - VG)$$

where  $VG$  is the input-to-output voltage gain. The gain  $VG$ , however, has a phase angle that varies with frequency. The phase angle is 180 degrees at low frequencies, but may lead or lag this value at high frequencies; the magnitude of  $VG$  then also varies. In the design of very wideband amplifiers (20 MHz or more), the phase of the transconductance  $g_m$  must be considered.

The video amplifier stage in a television receiver usually employs a pentode-type tube specially designed to amplify the wide band of frequencies contained in the video signal and, at the same time, to provide high gain per stage. Pentodes are more useful than triodes in such stages because they have high transconductance (to provide high gain) together with low input and output interelectrode capacitances (to permit the broadband requirements to be satisfied). An approximate "figure of merit" for a particular tube for this application can be determined from the ratio of its transconductance,  $g_m$ , to the sum of its input and output capacitances,  $C_{in}$  and  $C_{out}$ , as follows:

$$\text{Figure of Merit} = \frac{g_m}{C_{in} + C_{out}}$$

Typical values for this figure are in the order of  $500 \times 10^6$  or greater.

A typical video amplifier stage, such as that shown in Fig. 76, is connected between the second detector of the television receiver and the picture tube. The contrast control,  $R_3$ , in this circuit controls the gain of the video amplifier tube. The inductance,  $L_2$ , in series with the load resistor,  $R_L$ , maintains the plate load impedance at a relatively constant value with increasing

frequency. The inductance  $L_1$  isolates the output capacitance of the tube so that only stray capacitance is placed

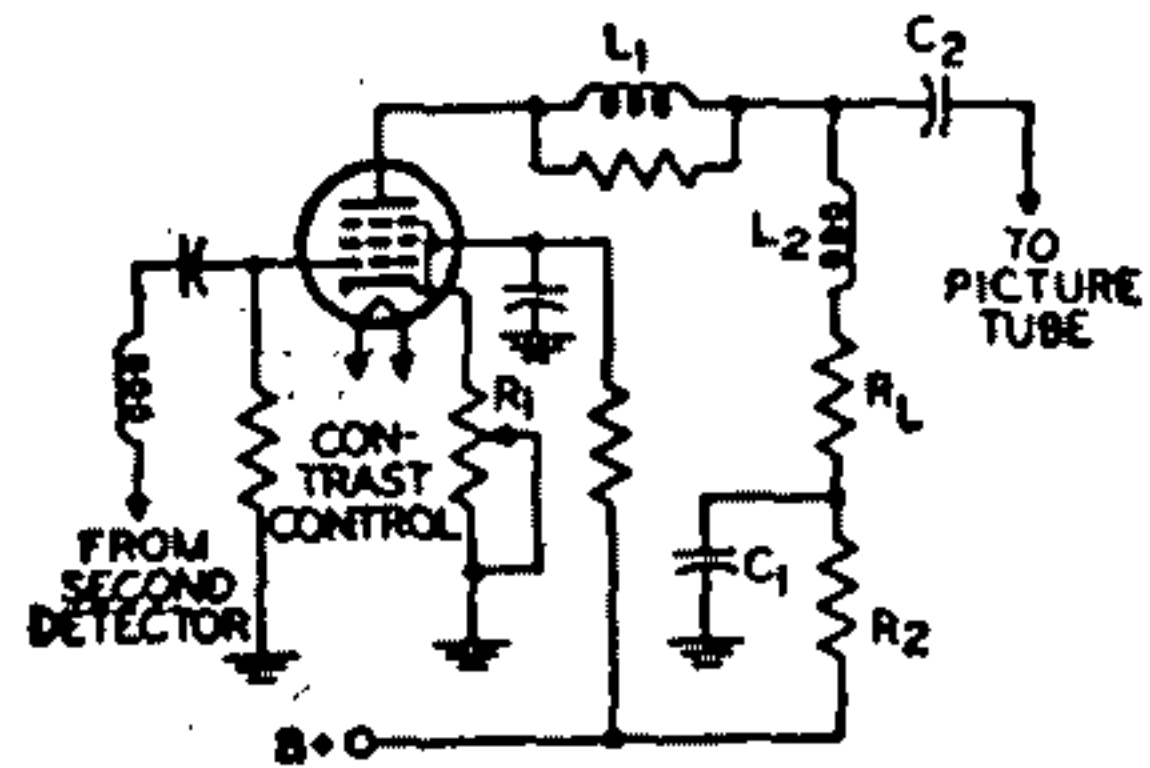


Fig. 76—Typical video amplifier stage.

across the load. As a result, a higher-value load resistor is used to provide higher gain without affecting frequency response or phase relations. The decoupling circuit,  $C_1R_2$ , is used to improve the low-frequency response. Tubes used as video amplifiers include types 6CL6 and 12BY7A, or the pentode sections of types 6AW8A and 6AN8A.

The luminance amplifier in a color-television receiver is a conventional video amplifier having a bandwidth of approximately 3.5 MHz. In a color receiver, the portion of the output of the second detector which lies within the frequency band from approximately 2.4 to 4.5 MHz is fed to a bandpass amplifier, as shown in the block diagram in Fig. 77. The color

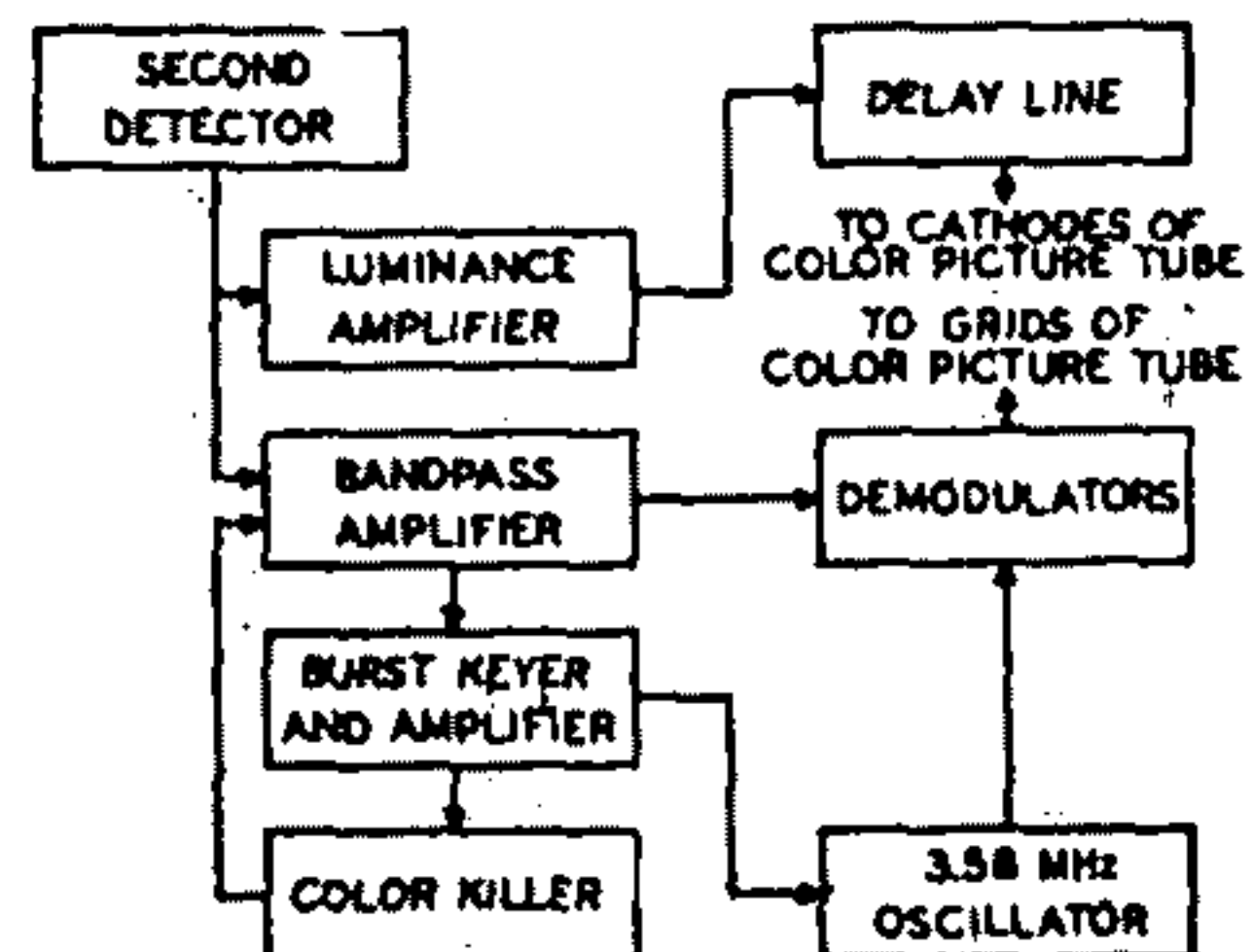


Fig. 77—Block diagram of video-amplifier section of color television receiver.

synchronizing signal, or "burst," contained in this signal may then be fed to a "burst-keyer" tube. At the same

time, a delayed horizontal pulse may be applied to the keyer tube. The output of the keyer tube is applied to the burst amplifier tube and the signal is then fed to the 3.58-MHz oscillator and to the "color-killer" stage.

The color killer applies a bias voltage to the bandpass amplifier in the absence of burst so that the color section, or chrominance channel, of the receiver remains inoperative during black-and-white broadcasts. A threshold control varies the bias and controls the burst level at which the killer stage operates.

The output of the 3.58-MHz oscillator and the output of the bandpass amplifier are fed into phase and amplitude demodulator circuits. The output of each demodulator circuit is an electrical representation of a color-difference signal, *i.e.*, an actual color signal minus the black-and-white, or luminance, signal. The two color-difference signals are combined to produce the third color-difference signal; each of the three signals then represents one of the primary colors.

The three color-difference signals are usually applied to the grids of the three electron guns of the color picture tube, in which case the black-and-white signal from the luminance amplifier may be applied simultaneously to the cathodes. The chrominance and luminance signals then combine to produce the color picture. In the absence of transmitted color information, the chrominance channel is cut off by the color killer, as described above, and only the luminance signal is applied to the picture tube, producing a black-and-white picture.

### TV Scanning, Sync, and Deflection

For reproduction of a transmitted picture in a television receiver, the

face of a cathode-ray tube is scanned with an electron beam while the intensity of the beam is varied to control the emitted light at the phosphor screen. The scanning is synchronized with a scanned image at the TV transmitter, and the black-through-white picture areas of the scanned image are converted into an electrical signal that controls the intensity of the electron beam in the picture tube at the receiver.

#### *Scanning Fundamentals*

The scanning procedures used in the United States employs horizontal linear scanning in an odd-line interlaced pattern. The standard scanning pattern for television systems includes a total of 525 horizontal scanning lines in a rectangular frame having an aspect ratio of 4 to 3. The frames are repeated at a rate of 30 per second, with two fields interlaced in each frame. The first field in each frame consists of all odd-number scanning lines, and the second field in each frame consists of all even-number scanning lines. The field repetition rate is thus 60 per second, and the vertical scanning rate is 60 Hz.

The geometry of the standard odd-line interlaced scanning pattern is illustrated in Fig. 78. The scanning beam starts at the upper left corner of the frame at point A, and sweeps across the frame with uniform velocity to cover all the picture elements in one horizontal line. At the end of each trace, the beam is rapidly returned to the left side of the frame, as shown by the dashed line, to begin the next horizontal line. The horizontal lines slope downward in the direction of scanning because the vertical deflecting signal simultaneously produces a verti-

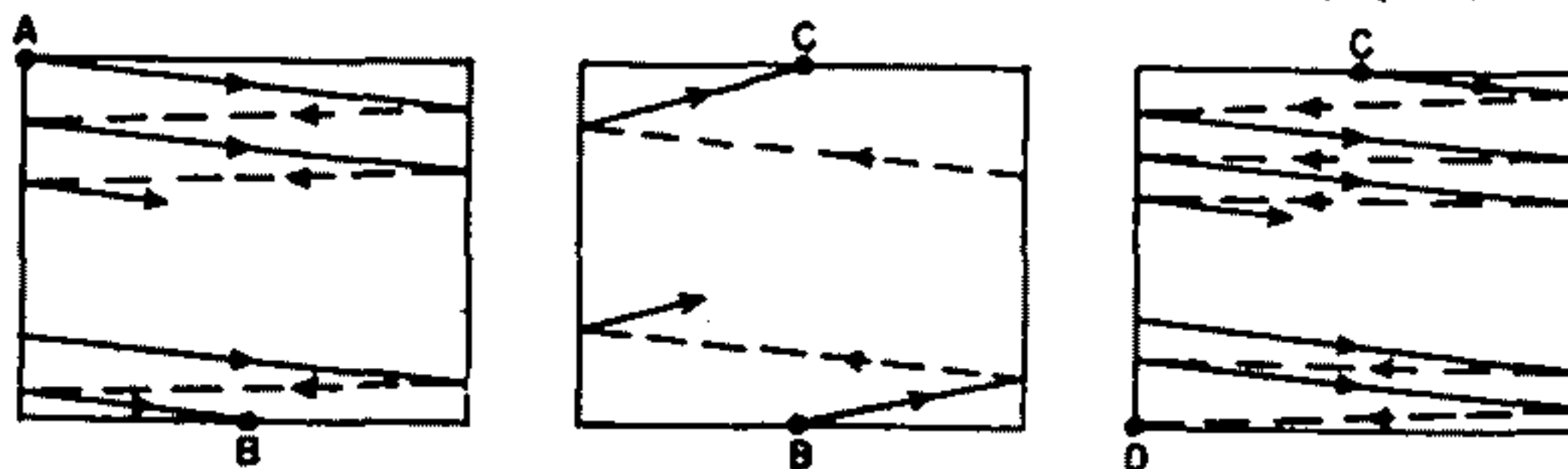


Fig. 78—The odd-line interlaced scanning procedure.



cal scanning motion, which is very slow compared with the horizontal scanning speed. The slope of the horizontal line trace from left to right is greater than the slope of the retrace from right to left because the shorter time of the retrace does not allow as much time for vertical deflection of the beam. Thus, the beam is continuously and slowly deflected downward as it scans the horizontal lines, and its position is successively lower as the horizontal scanning proceeds.

At the bottom of the field, the vertical retrace begins, and the beam is brought back to the top of the frame to begin the second or even-number field. The vertical "flyback" time is very fast compared to the trace, but is slow compared to the horizontal scanning speed; therefore, some horizontal lines are produced during the vertical flyback.

All odd-number fields begin at point A in Fig. 78 and are the same. All even-number fields begin at point C and are the same. Because the beginning of the even-field scanning at C is on the same horizontal level as A, with a separation of one-half line, and the slope of all lines is the same, the even-number lines in the even fields fall exactly between the odd-number lines in the odd field.

#### Sync

In addition to picture information, the composite video signal from the video detector of a television receiver contains timing pulses to assure that the picture is produced on the faceplate of the picture tube at the right instant and in the right location. These pulses, which are called sync pulses,

control the horizontal and vertical scanning generators of the receiver.

Fig. 79 shows a portion of the detected video signal. When the picture is bright, the amplitude of the signal is low. Successively deeper grays are represented by higher amplitudes until, at the "blanking level" shown in the diagram, the amplitude represents a complete absence of light. This "black level" is held constant at a value equal to 75 per cent of the maximum amplitude of the signal during transmission. The remaining 25 per cent of the signal amplitude is used for synchronization information. Portions of the signal in this region (above the black level) cannot produce light.

In the transmission of a television picture, the camera becomes inactive at the conclusion of each horizontal line and no picture information is transmitted while the scanning beam is retracing to the beginning of the next line. The scanning beam of the receiver is maintained at the black level during this retrace interval by means of the blanking pulse shown in Fig. 79. Immediately after the beginning of the blanking period, the signal amplitude rises further above the black level to provide a horizontal-synchronization pulse that initiates the action of the horizontal scanning generator. When the bottom line of the picture is reached, a similar vertical-synchronization pulse initiates the action of the vertical scanning generator to move the scanning spot back to the top of the pattern.

The sync pulses in the composite video signal may be separated from the video information in the output of the second or video detector by means of

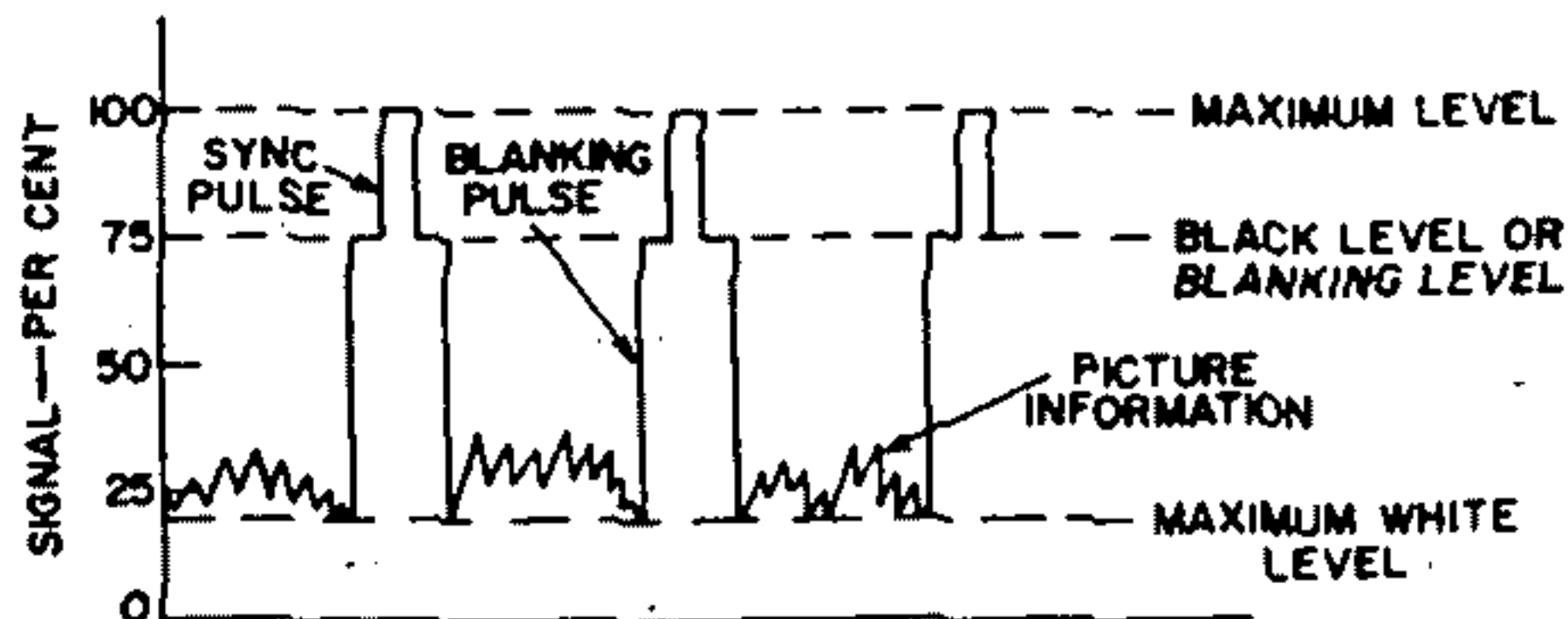


Fig. 79—Detected video signal.

the triode circuit shown in Fig. 80. In this circuit, the time constant of the network  $R_1C_1$  is long with respect to the interval between pulses. During each pulse, the grid is driven positive and draws current, thereby charging capacitor  $C_1$ . Consequently, the grid develops a bias which is slightly greater

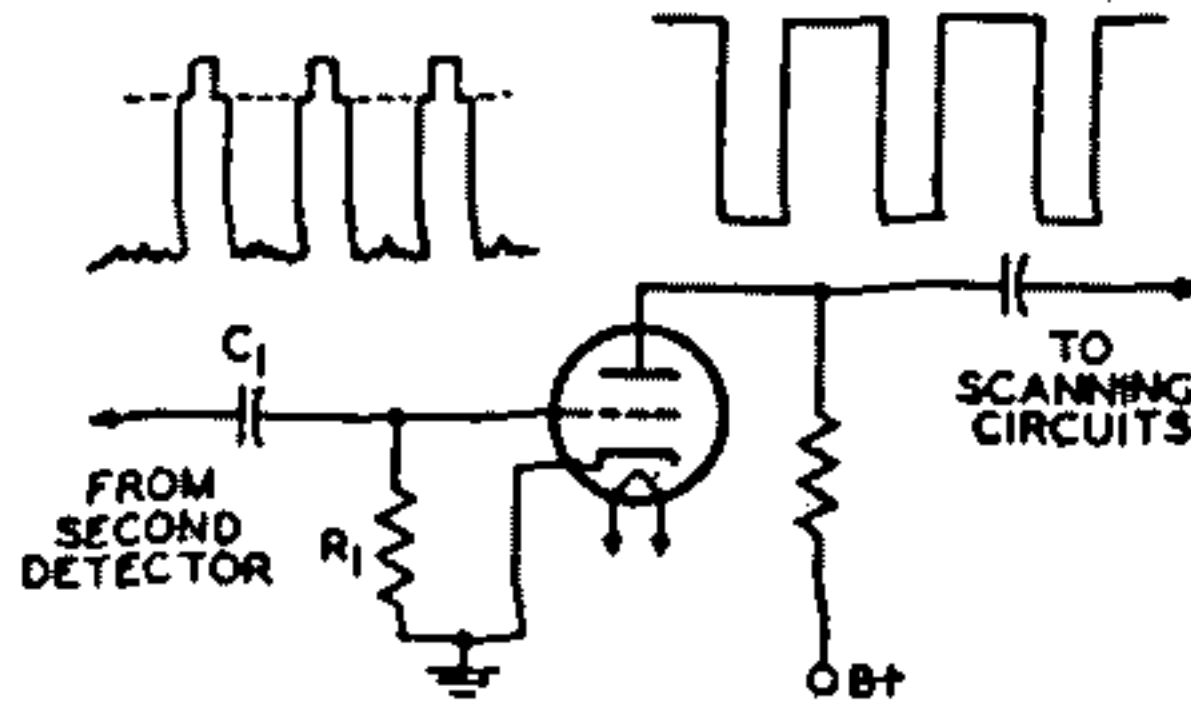


Fig. 80—Sync-separator circuit.

than the cutoff voltage of the tube. Because plate current flows only during the sync-pulse period, only the amplified pulse appears in the output. This sync-separator stage discriminates against the video information. Because the bias developed on the grid is proportional to the strength of the incoming signal, the circuit also has the advantage of being relatively independent of signal fluctuations.

After the synchronizing signals are separated from the composite video signal, it is necessary to filter out the horizontal and vertical sync signals so that each can be applied to its respective deflection generator. This filtering is accomplished by RC circuits designed to filter out all but the desired synchronizing signals. Although the horizontal, vertical, and equalizing pulses are all rectangular pulses of the same amplitude, they differ in frequency and pulse width, as shown in Fig. 81. The horizontal sync pulses have a repetition rate of 15,750 per second (one for

each horizontal line) and a pulse width of 5.1 microseconds. The equalizing pulses have a width approximately half the horizontal pulse width, and a repetition rate of 31,500 per second; they occur at half-line intervals, with six pulses immediately preceding and six following the vertical synchronizing pulse. The vertical pulse is repeated at a rate of 60 per second (one for each field), and has a width of approximately 190 microseconds. The serrations in the vertical pulse occur at half-line intervals, dividing the complete pulse into six individual pulses that provide horizontal synchronization during the vertical retrace. (Although the picture is blanked out during the vertical retrace time, it is necessary to keep the horizontal scanning generator synchronized.)

All the pulses described above are produced at the transmitter by the synchronizing-pulse generator; their waveshapes and spacings are held within very close tolerances to provide the required synchronization of receiver and transmitter scanning.

The horizontal sync signals are separated from the total sync in a differentiating circuit that has a short time constant compared to the width of the horizontal pulses. When the total sync signal is applied to the differentiating circuit shown in Fig. 82, the capacitor charges completely very soon after the leading edge of each pulse, and remains charged for a period of time equal to practically the entire pulse width. When the applied voltage is removed at the time corresponding to the trailing edge of each pulse, the capacitor discharges completely within a very short time. As a result, a positive peak of voltage is obtained for

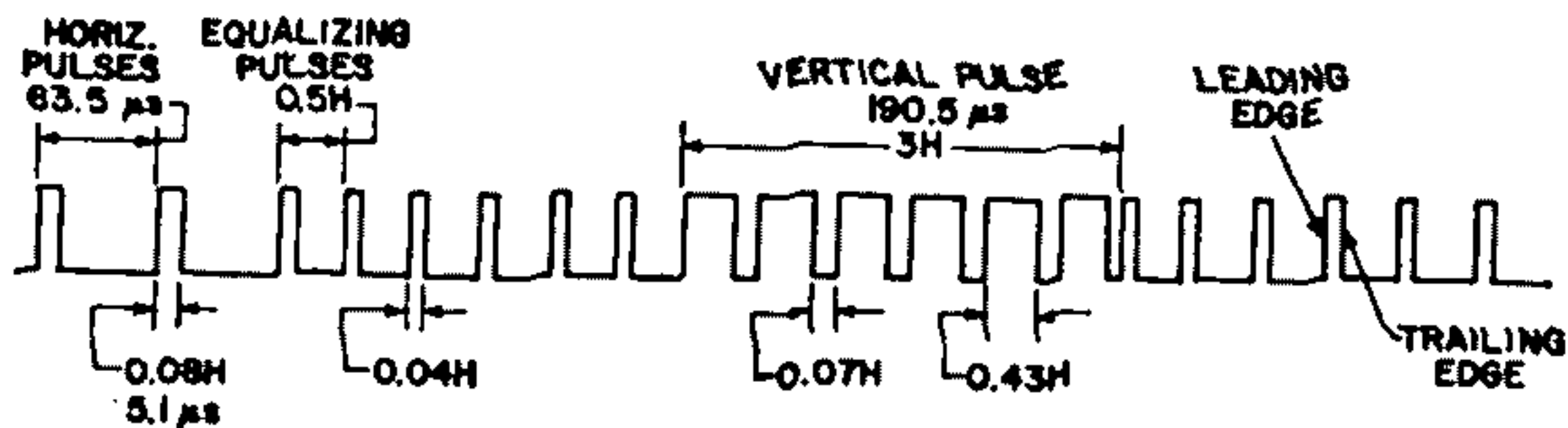


Fig. 81—Waveform of TV synchronizing pulses ( $H =$  horizontal line period of  $1/15,750$  seconds, or  $63.5 \mu s$ ).



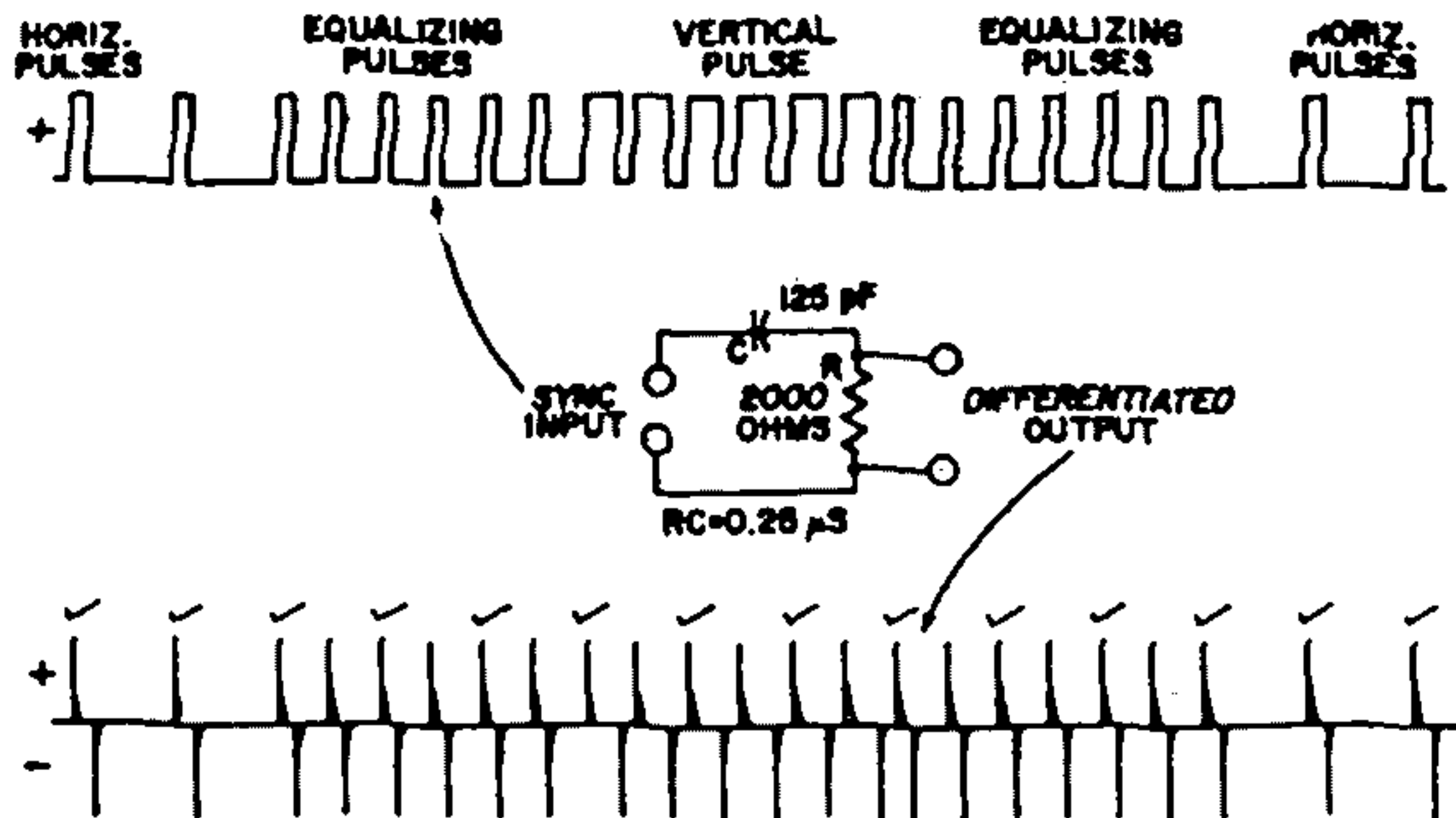


Fig. 82—Separation of the horizontal sync signals from the total sync by a differentiating circuit.

each leading edge and a negative peak for the trailing edge of every pulse. One polarity is produced by the charging current for the leading edge of the applied pulse, and the opposite polarity is obtained from the discharge current corresponding to the trailing edge of the pulse.

As mentioned above, the serrations in the vertical pulse are inserted to provide the differentiated output needed to synchronize the horizontal scanning generator during the time of vertical synchronization. During the vertical blanking period, many more voltage peaks are available than are necessary for horizontal synchronization (only one pulse is used for each horizontal line period). The check marks above the differentiated output in Fig. 82 indicate the voltage peaks used to synchronize the horizontal deflection generator for one field. Because the sync system is made sensitive only to positive pulses occurring at approximately the right horizontal timing, the negative sync pulses and alternate differentiated positive pulses produced by the equalizing pulses and the serrated vertical information have no effect on horizontal timing. It can be seen that although the total sync signal (including vertical synchronizing information) is applied to the circuit of Fig. 82, only horizontal synchronization information appears at the output.

The vertical sync signal is separated from the total sync in an integrating circuit which has a time constant that is long compared with the duration of the 5-microsecond horizontal pulses, but short compared with the 190-microsecond vertical pulse width. Fig. 83 shows the general circuit configuration

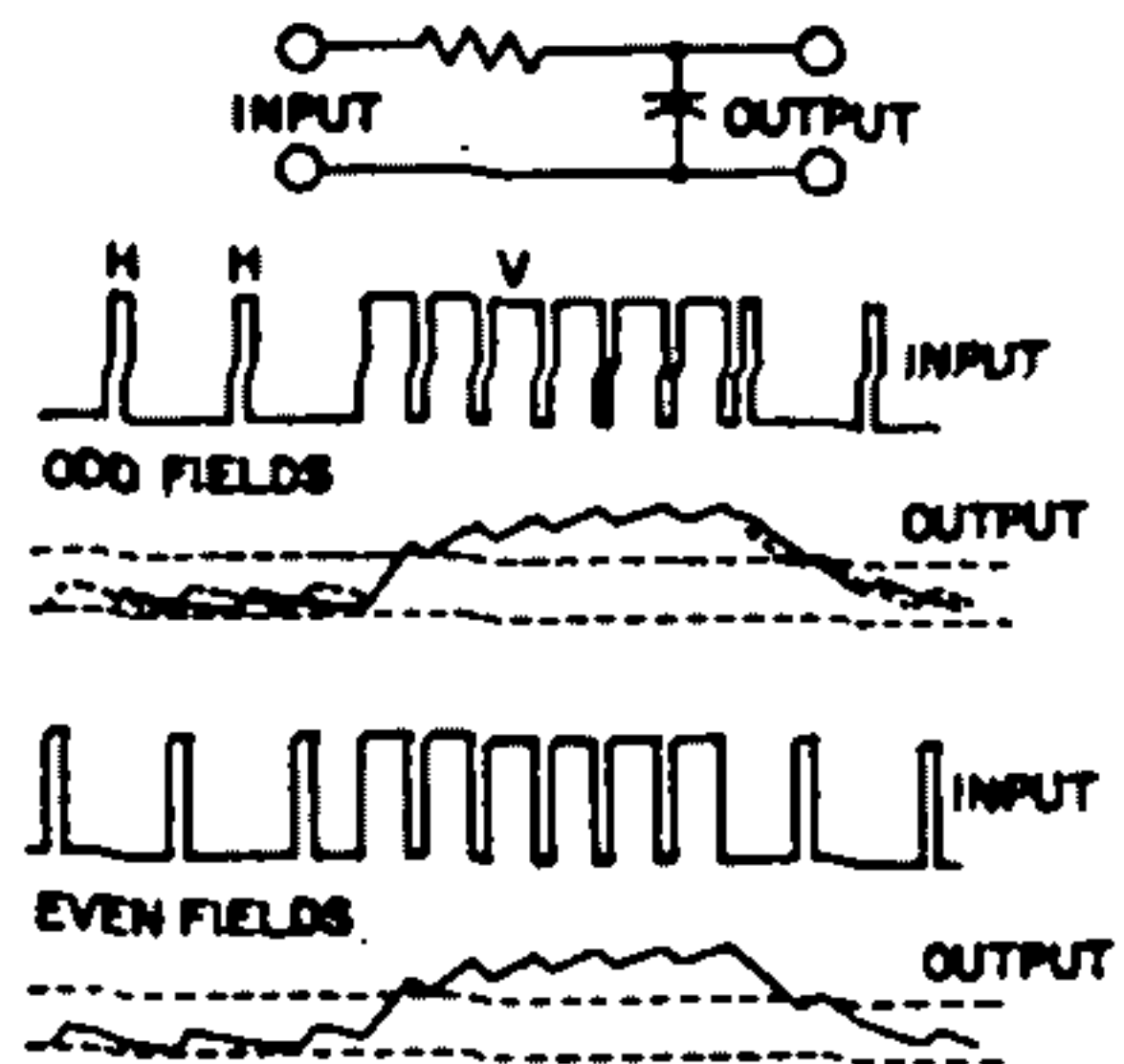


Fig. 83—Separation of vertical sync signals from the total sync for odd and even fields with no equalizing pulses. (Dashed line indicates triggering level for vertical scanning generator.)

used, together with the input and output signals for both odd and even fields. The period between horizontal pulses, when no voltage is applied to the RC circuit, is so much longer than the horizontal pulse width that the capacitor has time to discharge almost down to

zero. When the vertical pulse is applied, however, the integrated voltage across the capacitor builds up to the value required for triggering the vertical scanning generator. This integrated voltage across the capacitor reaches its maximum amplitude at the end of the vertical pulse, and then declines practically to zero, producing a pulse of the triangular wave shape shown for the complete vertical synchronizing pulse. Although the total sync signal (including horizontal information) is applied to the circuit of Fig. 83, therefore, only vertical synchronization information appears at the output.

The vertical synchronizing pulses are repeated in the total sync signal at the field frequency of 60 per second. Therefore, the integrated output voltage across the capacitor of the RC circuit of Fig. 83 can be coupled to the vertical scanning generator to provide vertical synchronization. The six equalizing pulses immediately preceding and following the vertical pulse improve the accuracy of the vertical synchronization for better interlacing. The equalizing pulses that precede the vertical pulses make the average value of applied voltage more nearly the same for even and odd fields, so that the integrated voltage across the capacitor adjusts to practically equal values for the two fields before the vertical pulse begins. The equalizing pulses that follow the vertical pulse minimize any

difference in the trailing edge of the vertical synchronizing signal for even and odd fields.

In fringe areas, two conditions complicate the process of sync separation. First, the incoming signal available at the antenna is weak and susceptible to fading and other variations; second, the receiver is operating at or near maximum gain, which makes it extremely susceptible to interference from pulse-type noise generated by certain types of electrical equipment, ignition systems, switches, or the like. Some type of noise-immunity provision is almost essential for acceptable performance. Noise may be reduced or eliminated from the sync and agc circuits by gating or by a combination of gating, inversion, and cancellation. An example, of the latter method is shown in Fig. 84. In this circuit the 6GY6, which has two independent control grids, serves the dual function of agc amplifier and noise inverter. Because the sync tips of the video signal at grid No. 1 of the 6GY6 drive the tube near its cutoff region, any noise signal extending above the tip level will appear inverted across the grid-No.2 load resistor R. This inverted noise signal is re-combined with the video signal and fed to the sync separator at point "A" in Fig. 84, where noise cancellation takes place. This process leaves the sync pulses relatively free of disturbing noise and results in a stable picture.

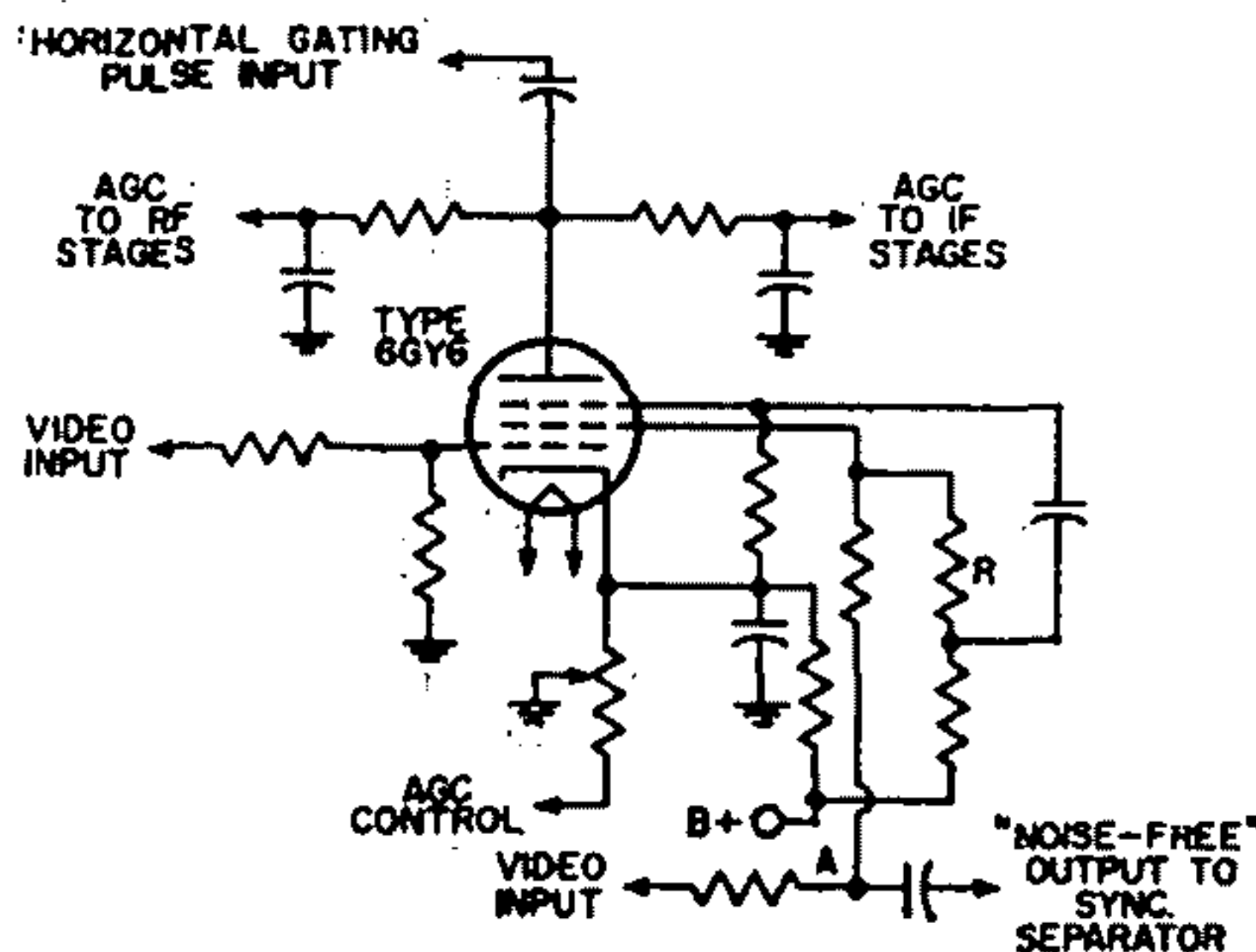


Fig. 84—Typical noise-cancellation circuit.



To prevent reduction of receiver gain due to the effect of noise on the agc amplifier, a portion of the inverted noise signal is fed to the second control grid, grid No.3, of the 6GY6 to cut off or gate the agc amplifier when a noise pulse occurs.

### Horizontal Deflection

In the horizontal-deflection stages of a television receiver, a current that varies linearly with time and has a sufficient peak-to-peak amplitude must be passed through the horizontal-deflection-yoke winding to develop a magnetic field adequate to deflect the electron beam of the television picture tube. (This type of deflection is different from that used in a cathode-ray oscilloscope, where the beam is deflected electrostatically.) After the beam is deflected completely across the face of the picture tube, it must be returned very quickly to its starting point. (As explained previously, the beam is extinguished during this retrace by the blanking pulse incorporated in the composite video signal, or in some cases by additional external blanking derived from the horizontal-deflection system.)

The simplest form of a deflection circuit is shown in Fig. 85. In this circuit, the yoke impedance  $L$  is assumed to be a perfect inductor. When the



Fig. 85—Simplest form of deflection circuit.

switch is closed, the yoke current starts from zero and increases linearly. At any time  $t$ , the current  $i$  is equal to  $Et/L$ , where  $E$  is the applied voltage. When the switch is opened at a later time  $t_1$ , the current instantly drops from a value of  $Et_1/L$  to zero.

Although the basic circuit of Fig. 85 crudely approaches the requirements for deflection, it presents some obvious problems and limitations. The voltage across the switch becomes extremely

high, theoretically approaching infinity. In addition, if very little of the total time is spent at zero current, the circuit would require a tremendous amount of dc power. Furthermore, the operation of the switch would be rather critical with regard to both its opening and its closing. Finally, because the deflection field would be phased in only one direction, the beam would have to be centered at the extreme left of the screen for zero yoke current.

If a capacitor is placed across the switch, as shown in Fig. 86, the yoke

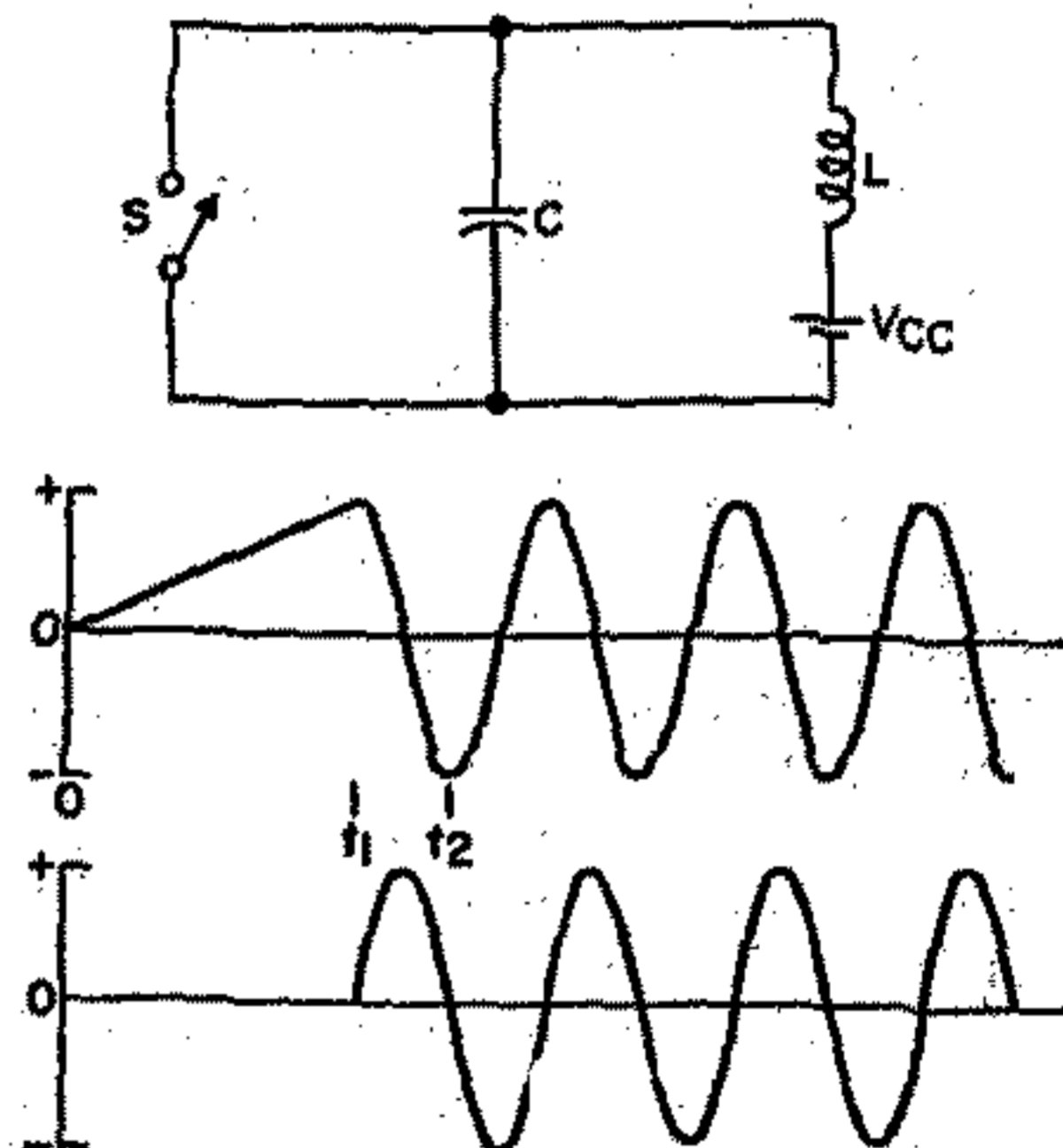


Fig. 86—Addition of capacitor to permit flyback ringing, and yoke-current (upper) and switch-voltage (lower) waveforms.

current still increases linearly when the switch is closed at time  $t = 0$ . However, when the switch is opened at time  $t = t_1$ , a tuned circuit is formed by the parallel combination of  $L$  and  $C$ . The resulting yoke currents and switch voltages are then as shown in Fig. 86. The current is at a maximum when the voltage equals zero, and the voltage is at a maximum when the current equals zero. If it is assumed that there are no losses, the ringing frequency  $f_{osc}$  is equal to  $1/(2\pi\sqrt{LC})$ .

If the switch is closed again at any time the capacitor voltage is not equal to zero, an infinite switch current flows as a result of the capacitive discharge. However, if the switch is closed at the precise moment  $t_2$  that the capacitor voltage equals zero, the capacitor cur-

rent effortlessly transfers to the switch, and a new transient condition results. Fig. 87 shows the yoke-current and switch-voltage waveforms for this new condition.

If the switch is again opened at  $t_4$ , closed at  $t_5$ , and so on, the desired

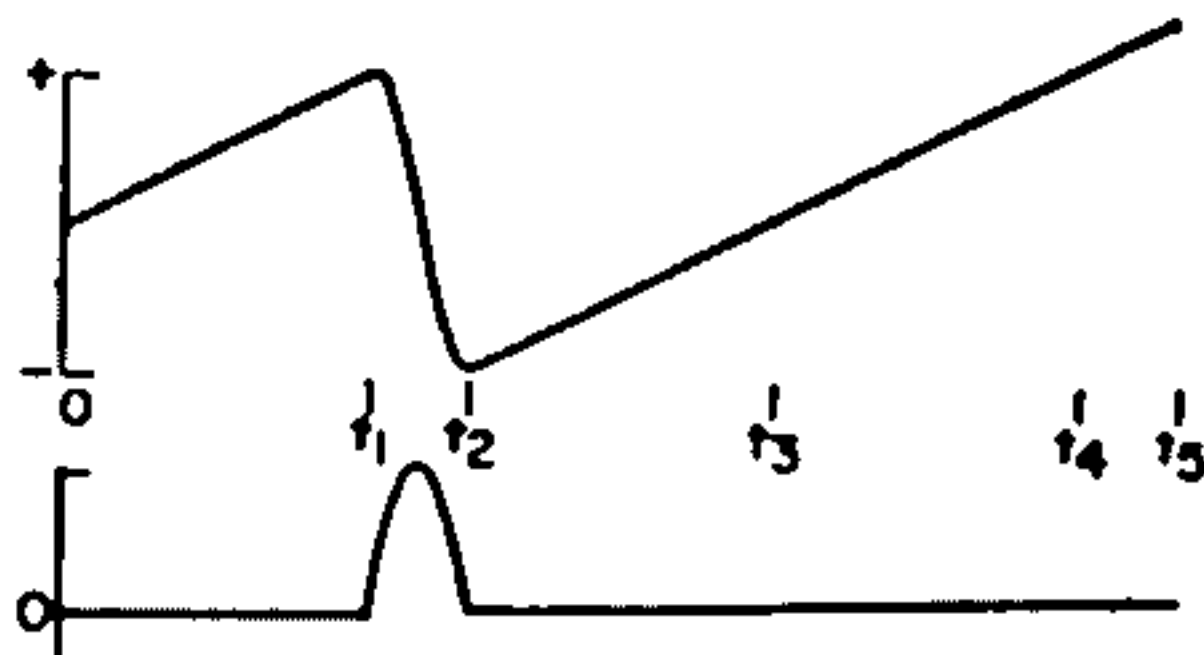


Fig. 87—Yoke-current (upper) and switch-voltage (lower) waveforms when switch is closed at  $t_2$ .

sweep results, the peak switch voltage is finite, and the average supply current is zero. The deflection system is then lossless and efficient and, because the average yoke current is zero, beam decentering is avoided. The only fault of the circuit of Fig. 86 is the critical timing of the switch, particularly at time  $t = t_2$ . However, if the switch is shunted by a damper diode, as shown in Fig. 88, the diode acts as a closed switch as soon as the capacitor voltage reverses slightly. The switch may then be closed at any time between  $t_2$  and  $t_4$ .

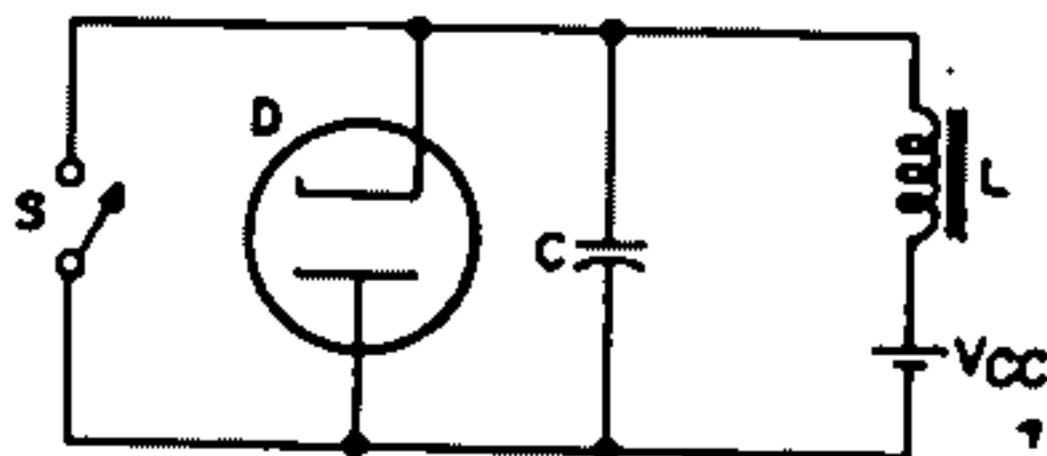


Fig. 88—Incorporation of damper diode.

output-and-deflection circuit used in television receivers. In addition to supplying the deflection energy required for horizontal deflection of the picture-tube beam, this circuit provides the high dc voltage required for the ultor (anode) of the picture tube and the "boosted" B voltage for other portions of the receiver. The horizontal-output tube is usually a beam power tube such as the 6JB6A, 6JG6A, or 6JE6A.

In this circuit, a sawtooth voltage from the horizontal-oscillator tube is

applied to the grid No. 1 of the horizontal-output tube. When this voltage rises above the cutoff point of the output tube, the tube conducts a sawtooth of plate current which is fed through the auto-transformer to the horizontal-deflecting yoke. At the end of the horizontal-scanning cycle, which lasts for 63.4 microseconds, the sawtooth voltage on the grid suddenly cuts off the output tube. This sudden change sets up an oscillation of about 50 to 70 KHz in the output circuit, which may be considered as inductor shunted by the stray capacitance of the circuit. During the first half of this oscillation, a positive voltage appears across the transformer. In the

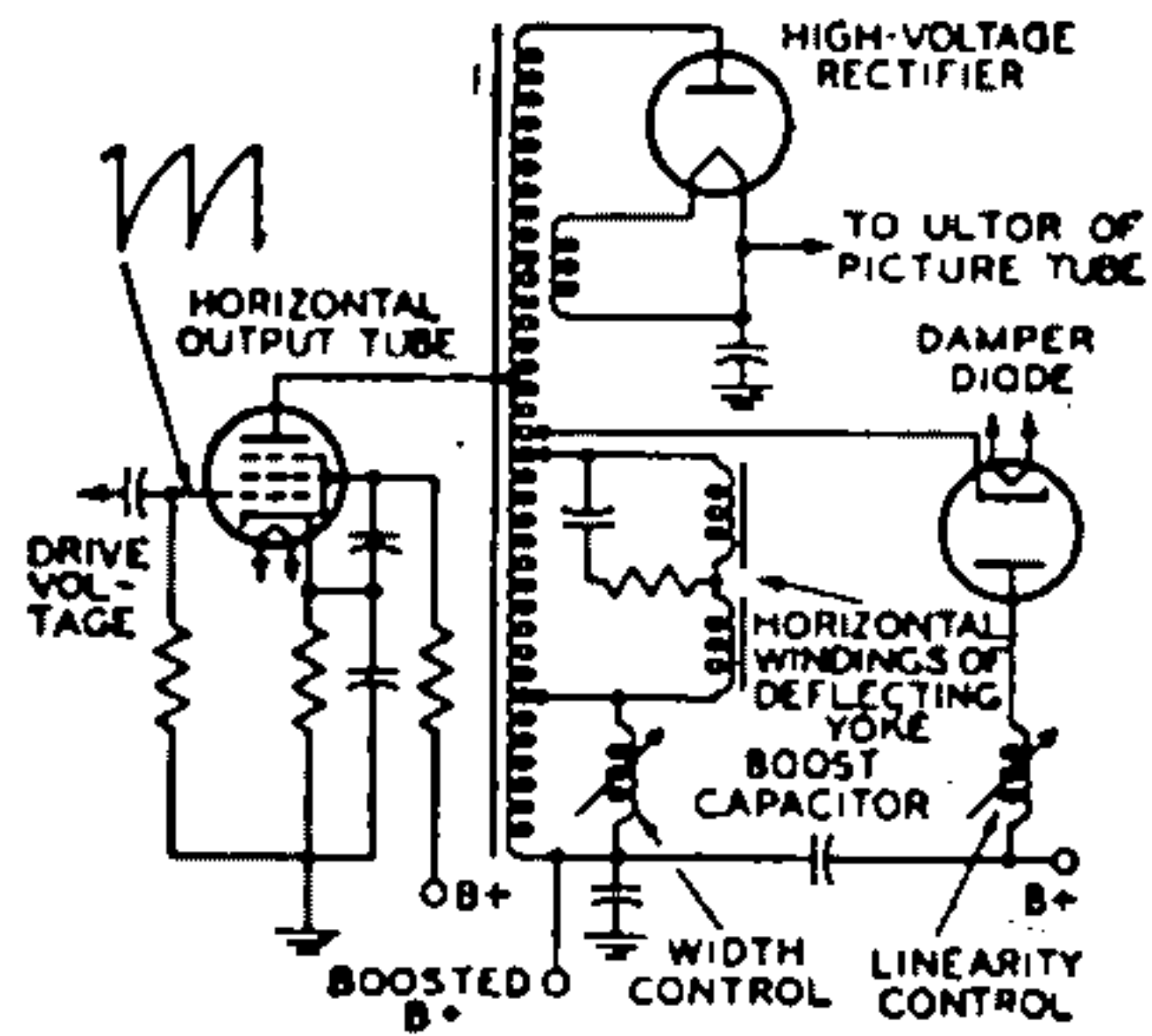


Fig. 89—Typical horizontal-deflection and high-voltage circuit.

second half of the cycle, the voltage swings below the plate supply voltage, and the damper diode conducts, damping out the oscillation. At the same time, the current through the deflecting yoke reverses and reaches its negative peak. As the damper-diode current decays exponentially to zero, the output tube begins to conduct again. The yoke current, therefore, is composed of current resulting from damper-diode conduction followed by output-tube conduction.

When the output tube is suddenly cut off, the high-voltage pulse produced by shock excitation of the load circuit is increased by means of an extra winding on the transformer. This high-voltage pulse charges a high-voltage capacitor through the high-voltage rectifier. The output of this circuit is the dc high-



voltage supply for the picture tube. The high-voltage rectifier also obtains its filament power through a separate winding on the horizontal-output transformer.

Current flowing through the damper diode charges the "boost" capacitor through the damper portion of the transformer winding. The polarity of the charge on the capacitor is such that the voltage at the low end of the winding is increased above the plate supply voltage, or  $B+$ . This higher voltage or "boost" is used for the output-tube plate supply, and may also supply the deflection oscillators and the vertical-output circuit provided the current drain is not excessive.

### Vertical Deflection

The vertical-deflection circuit in a television receiver is essentially a class A audio amplifier with a complex load line, severe low-frequency requirements (much lower than 60 Hz), and a need for controlled linearity. The equivalent low-frequency response for a 10-percent deviation from linearity is 1 Hz.

The required performance can be obtained in a vertical-deflection circuit in any of three ways. The amplifier may be designed to provide a flat response down to 1 Hz. This design, however, requires an extremely large output transformer and immense capacitors. Another arrangement is to design the amplifier for fairly good low-frequency response and predistort the generated signal.

The third method is to provide extra gain so that feedback techniques can be used to provide linearity. If loop feedback of 20 or 30 dB is used, tube gain variations and non-linearities become fairly insignificant. The feedback automatically provides the necessary "predistortion" to correct low-frequency limitations. In addition, the coupling of miscellaneous signals (such as power-supply hum or horizontal-deflection signals) in the amplifying loop is suppressed.

A modified multivibrator in which the vertical output tube is part of the oscillator circuit is used in the vertical deflection stage of many television receivers. This stage supplies the deflection energy required for vertical deflection of the picture-tube beam. A simplified combined vertical-oscillator-output stage is shown in Fig. 90. Wave-shapes at critical points of the circuit are included to illustrate the development of the desired current through the vertical output transformer and deflecting yoke.

The current waveform through the deflecting yoke and output transformer should be a sawtooth to provide the desired deflection. The grid and plate voltage waveforms of the output tube could also be sawtooth except for the effect of the inductive components in the yoke and transformer. The effect of these inductive components must be taken into consideration, however, particularly during retrace. The fast rate of current change during retrace time (which is approximately 1/15 as long as trace

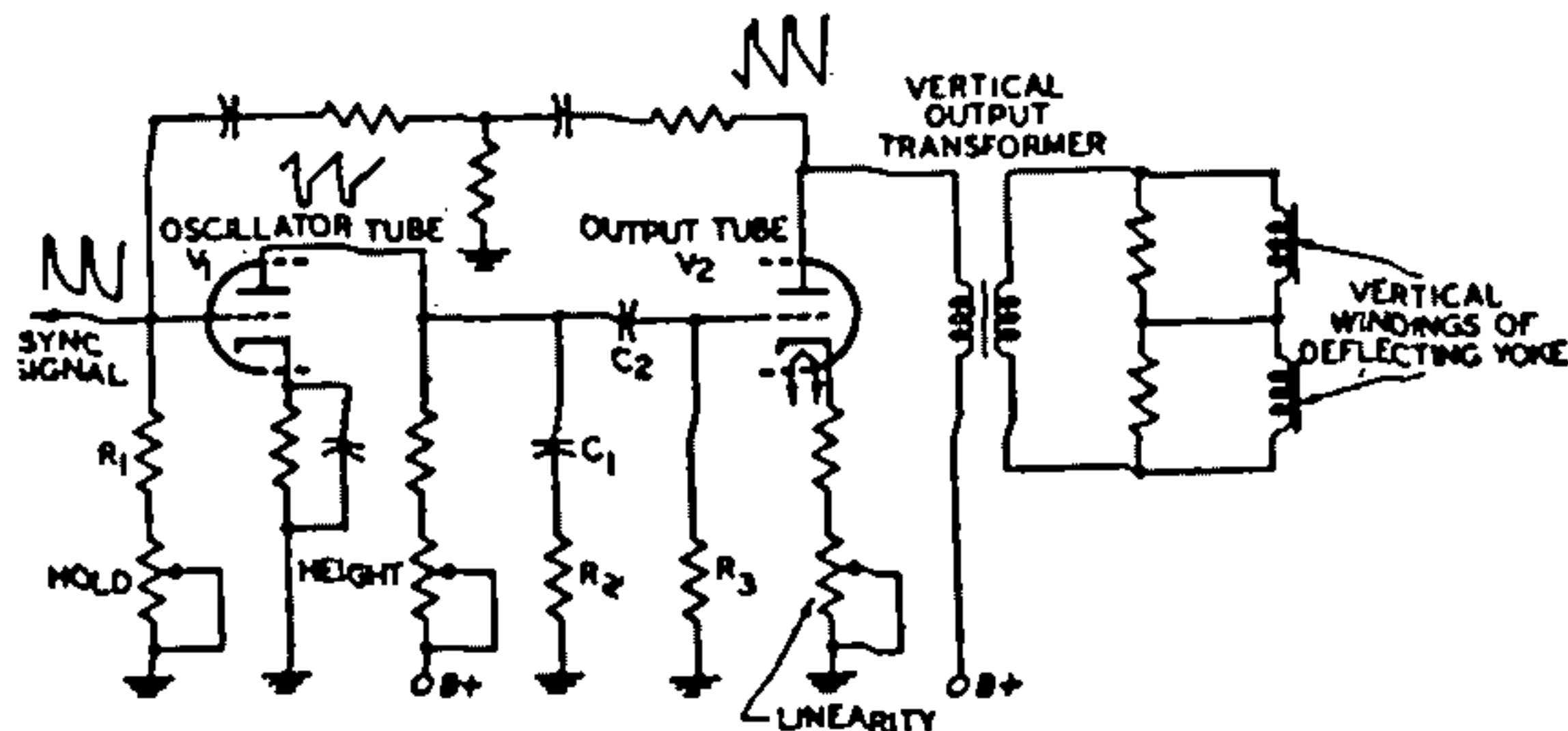


Fig. 90—Simplified combined vertical-oscillator-and-output stage.

time) causes a high-voltage pulse at the plate which could give a trapezoidal waveshape to the plate voltage and cause increased plate current, excess damping, and lengthened retrace time. However, the grid voltage is made sufficiently negative during retrace to keep the tube close to cutoff, as described below.

The frequency, and the relative deviation of the positive and negative portions of each cycle, are dependent on the values of resistors  $R_1$  and  $R_2$  and the RC combination  $R_2C_1$ , as explained previously in the section on multivibrators. The desired trapezoidal waveshape at the grid of  $V_1$  is created by capacitor  $C_1$  and resistor  $R_2$ . If  $R_2$  were equal to zero,  $C_1$  would cause the grid-voltage waveshape to take the form shown in Fig. 91(a). When  $R_2$  is sufficiently large,  $C_1$  does not discharge completely when  $V_1$  conducts. When  $V_1$  is cut off, therefore, the voltage on the grid of  $V_1$  immediately rises to the voltage across  $C_1$ . The resulting waveshape is shown in Fig. 91(b). The negative-going pulse of the grid-voltage waveshape prevents the high plate pulse from causing excess conductance, and thereby prevents overdamping.



Fig. 91—Waveforms showing effect of  $R_2$  in Fig. 90.

This vertical deflection stage utilizes twin-triode tubes such as the 6DR7 and 6EM7. The 6EM7 is particularly suitable for this application because it incorporates dissimilar units to provide for the different operating requirements of the oscillator and output sections.

### High-Voltage Regulator Circuit

In color-television receivers, it is very important to regulate the high-voltage supply to the picture tube. A suitable circuit using the 6BK4A for regulation of the output of a high-voltage, high-impedance supply is shown in Fig. 92. In this circuit, the cathode

is held at a fixed positive potential with respect to ground. Because the grid potential is kept slightly less positive by the voltage drop across resistor  $R_2$ , the tube operates in the negative grid region and no grid current is drawn.

When the output voltage,  $e_o$ , rises as a result of a decrease in load current,

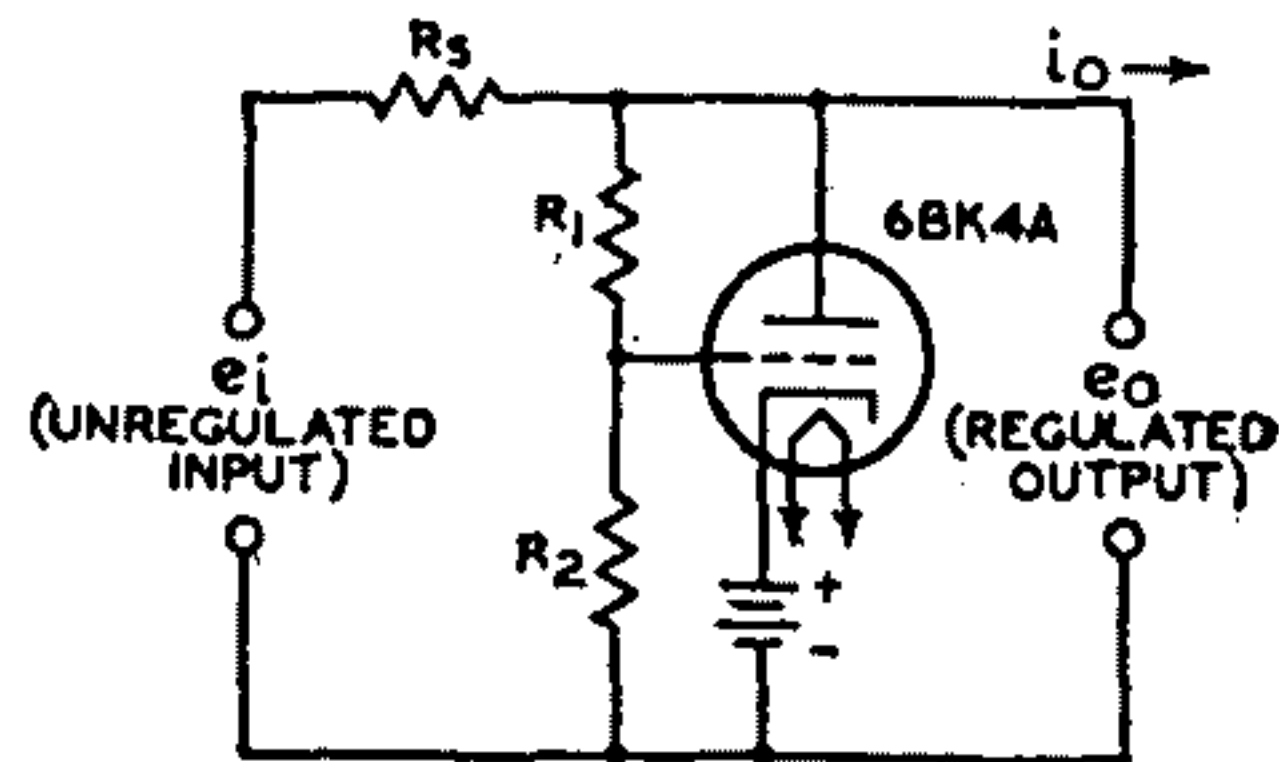


Fig. 92—High-voltage regulator circuit for color television.

a small fraction of the additional voltage is applied to the grid of the tube by the voltage-divider circuit consisting of  $R_1$  and  $R_2$ . This increased grid voltage causes the tube to draw an increased current from the unregulated supply. The increased current, in turn, causes a voltage drop across the high internal impedance of the unregulated supply,  $R_3$ , which tends to counteract the original rise of the voltage. If desired, the grid may be connected to a variable point on the voltage divider to allow some adjustment of the output-voltage level.

The grid voltage for the 6BK4A can also be obtained from a tap on the B-boost voltage supply. The use of this lower voltage (about 375 volts) eliminates the need for costly and troublesome high-voltage resistors. In this arrangement, variations in high voltage also vary the tapped-down B-boost voltage at the regulator grid, and the resulting variations in conduction of the regulator increase or decrease the loading of the high-voltage supply so that the total load remains nearly constant.

### Color Demodulation

In the transmission of picture signals for color-television receivers, all the color information is contained in three signals, a luminance (black-and-



white) or monochrome signal and two chrominance signals. The luminance signal, which is called the Y signal, contains brightness information only. The voltage response of the Y signal is made similar to the brightness response of the human eye by use of a composite signal that contains definite proportions of the red, green, and blue signals from the color-television camera (30 per cent red, 59 per cent green, and 11 per cent blue). This Y signal, which includes sync and blanking pulses, provides a correct monochrome picture in a conventional black-and-white television receiver.

For the generation of color-television signals, the Y signal is subtracted from the red, green, and blue signals to provide a new set of color-difference signals, which are designated as R-Y, B-Y, and G-Y. All of the original picture information is contained in the Y signal, the R-Y signal, and the B-Y signal. Therefore, the G-Y signal is not contained in the transmitted signal, but is synthesized in the receiver by proper combination of the R-Y and B-Y signals.

(Color signals transmitted under present color-television standards are not R-Y and B-Y, but a similar pair of signals designated as I and Q. In the color-television receiver, R-Y and B-Y signals are demodulated directly from the I and Q signals with negligible loss of color quality. For purposes of simplicity, only R-Y and B-Y signals are considered in this explanation. In addition, a 90-degree phase-shift network is shown; the phase-shift angle could be, and often is, some other value.)

Because the luminance signal and

the two color-difference signals must be transmitted with a standard 6-MHz channel, the two color signals are combined into one signal at the transmitter and are independently recovered at the receiver by proper detection techniques. A color subcarrier of approximately 3.58 MHz is used for transmitting the color information within the 6-MHz spectrum of the television station. As shown in Fig. 93, the 3.58-MHz subcarrier and one of the color-difference signals are applied directly to a balanced AM modulator. The other color-difference signal is applied directly to a second balanced AM modulator, and the 3.58 MHz subcarrier is applied to this second modulator through a 90-degree phase-shifting network. The balanced modulators effectively cancel both the individual color-difference signals and the subcarrier signal, and the output contains only the side-bands of the combined chrominance signal.

Recovery of the color information at the receiver involves a process called **synchronous detection**. In this process, two separate detectors are used to recover the separate color information, just as two separate modulators were used to combine the information at the transmitter. The 3.58-MHz subcarrier, which was suppressed during transmission, must be reinserted at the receiver for recovery of the color information. The basis of synchronous detection is the phase relationship of this reinserted 3.58-MHz subcarrier.

For example, the original color information is represented in Fig. 93 by the color-difference signals A and B. At the receiver, the combined color

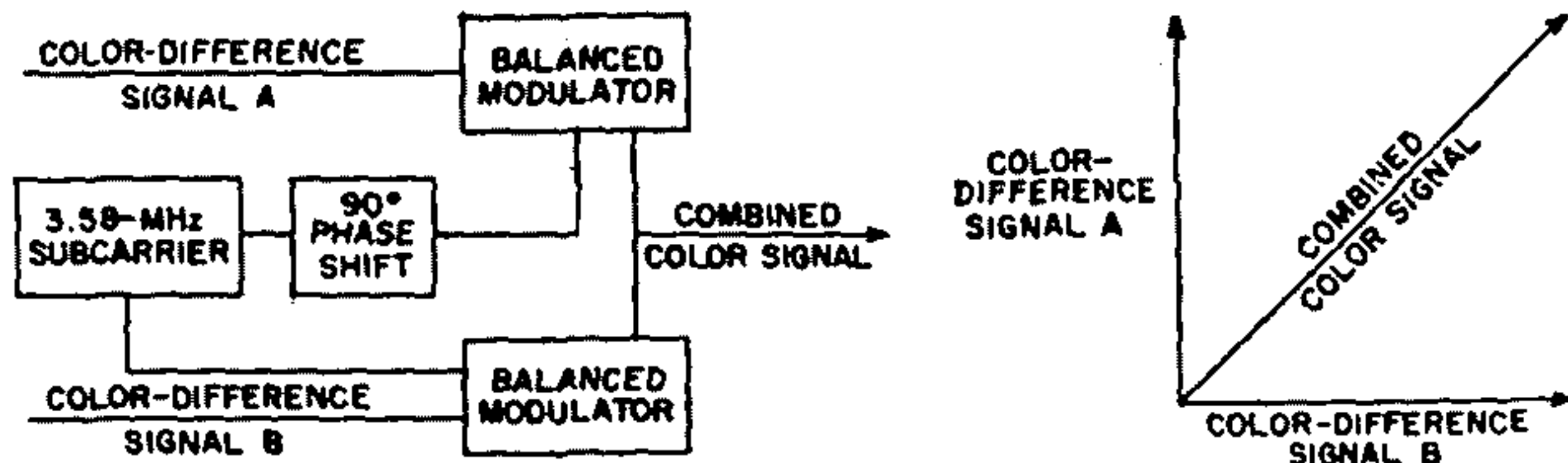


Fig. 93—Formation of combined color signal for transmission.

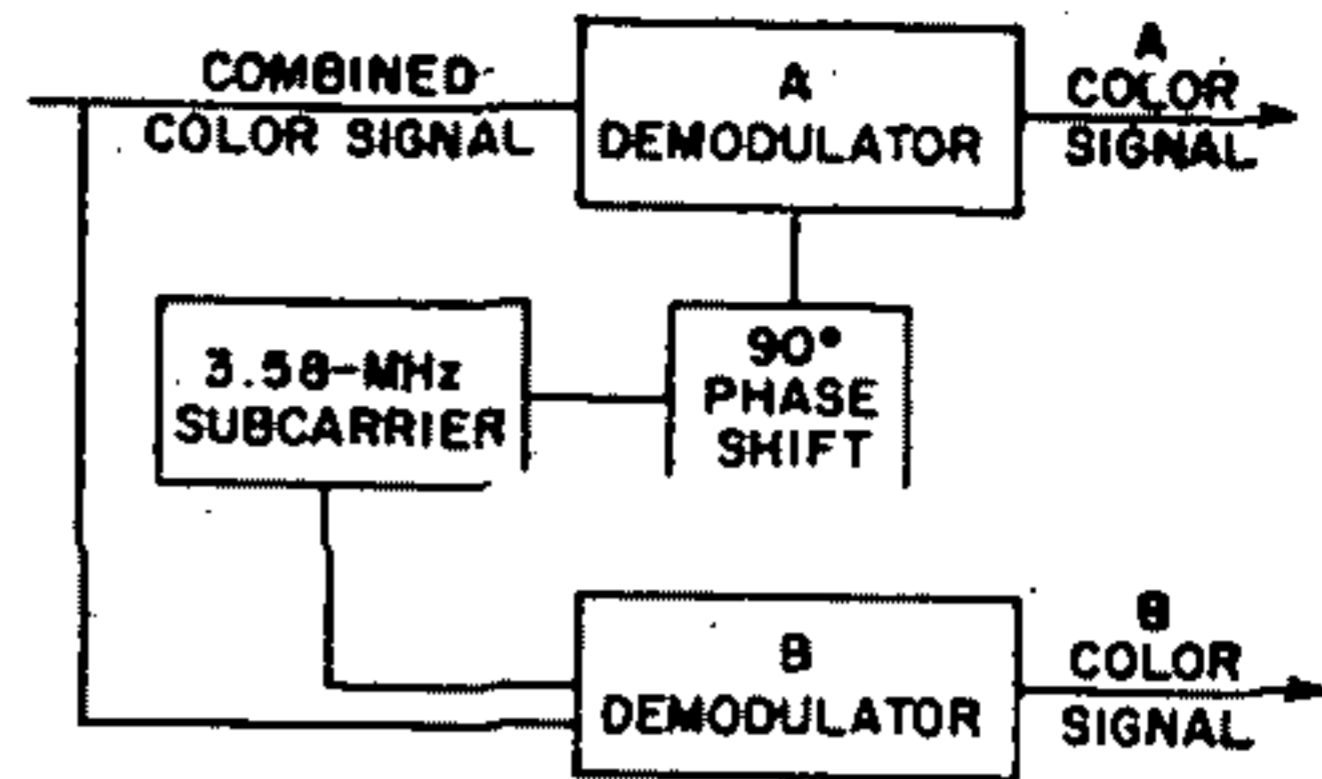
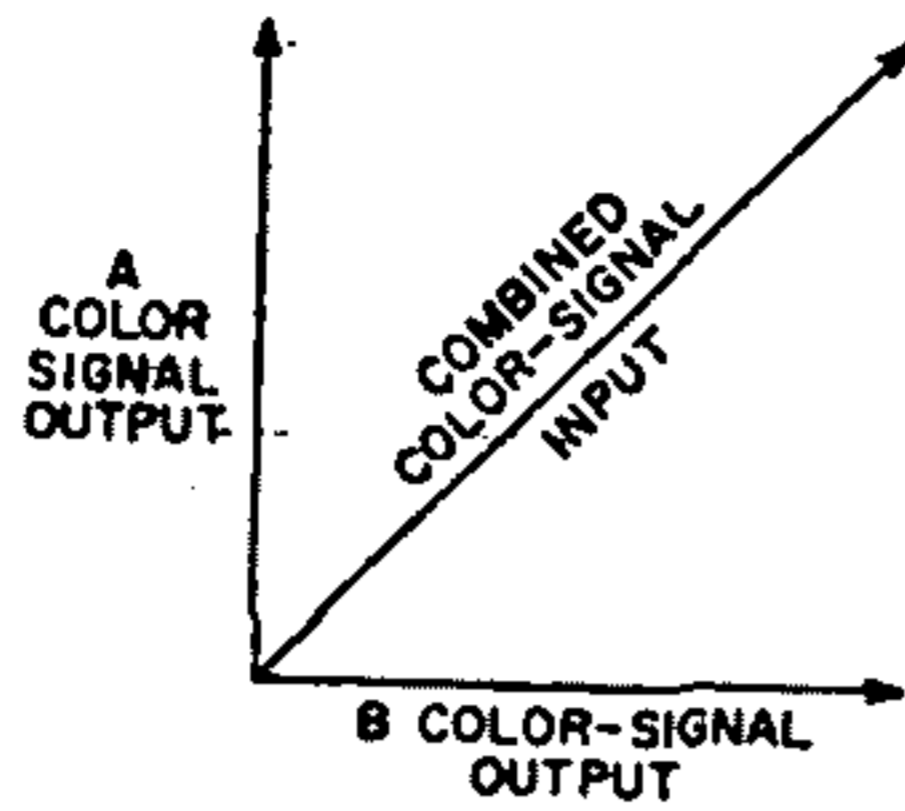


Fig. 94—Separation of combined color signal into two signals at the receiver.

signal is fed to two demodulators A and B, as shown in Fig. 94. At the same time, a 3.58-MHz subcarrier is also fed to the two demodulators, with the same phase relationship that was used in the modulators at the transmitter. This locally generated subcarrier essentially duplicates or replaces the original subcarrier, which was removed at the transmitter.

The local 3.58-MHz oscillator in the color-television receiver is made to function at the proper frequency and phase by means of a synchronizing signal sent out by the transmitter. This synchronizing signal consists of a short burst of 3.58-MHz signals transmitted during the horizontal blanking interval, immediately after the horizontal sync pulse, as shown in Fig. 95.

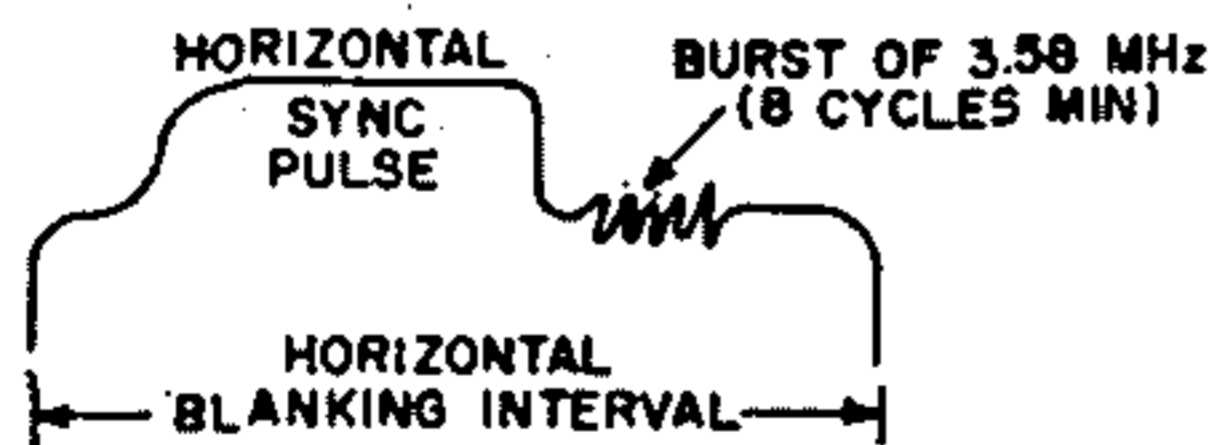


Fig. 95—Waveform for synchronizing signal.

Fig. 96 shows a simplified diagram of a low-level color demodulator frequently used in color-television receivers. The locally generated 3.58-MHz signal is applied to the grid No. 3 of the pentode. The transmitted color signal containing the 3.58-MHz sidebands is applied to grid No. 1. The phase of the 3.58-MHz color signal constantly changes in accordance with its color content. For example, the following table shows six variations in color (hue) as a function of subcarrier phase:

Subcarrier Phase-degrees (with respect to 3.58-MHz local signal in phase with burst)	Hue
13	Yellow
77	Red
119	Magenta
193	Blue
257	Cyan
299	Green

The basic operating principle of the color demodulator shown in Fig. 96 is that plate current from the pentode is zero (or quite low) unless both grid No. 1 and grid No. 3 are simultaneously positive. For example, when the signals applied to the two grids are in phase, plate current can be expected to flow for 180 degrees of each ac cycle. Conversely, when the signals are 180 degrees out of phase, plate current is cut off. The output signal from the detector, therefore, is a function of the phase relationship between the transmitted color signal and the locally generated subcarrier.

In a typical color-television receiver, two color demodulators of the type shown in Fig. 96 are required. In one demodulator, the 3.58-MHz subcarrier signal is applied directly to the pentode grid No. 3 from the local "burst" oscillator. In the other demodulator, the 3.58-MHz signal from the

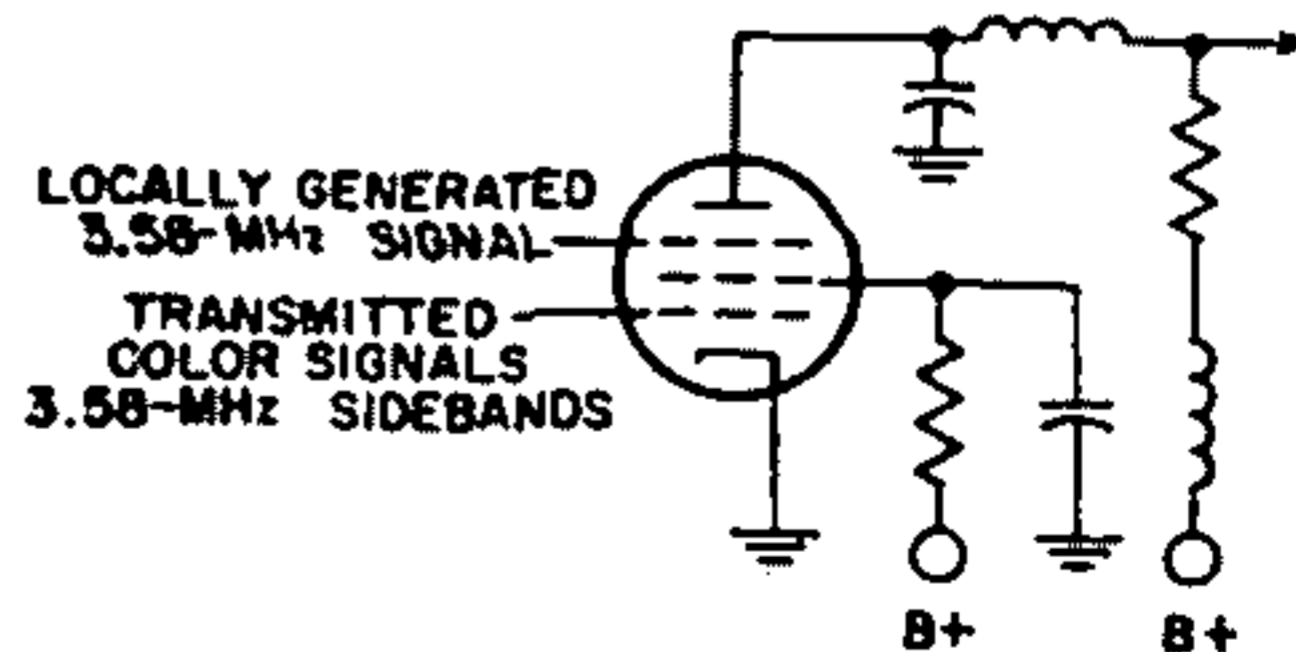


Fig. 96—Low-level color demodulator.



burst oscillator is shifted 90 degrees in phase before it is applied to the pentode grid No. 3. As shown previously in Fig. 94, the demodulator B produces R-Y signals. These B-Y and R-Y signals are then combined (matrixed) to produce the G-Y signal, as discussed earlier. The complete luminance signal is then amplified to the required level in a conventional video-amplifier circuit.

In some color-television receivers, the demodulators are designed so that the color output signals can be applied directly to the color picture tube. In the diagram shown in Fig. 97, for example, the 6JH8 sheet-beam demodula-

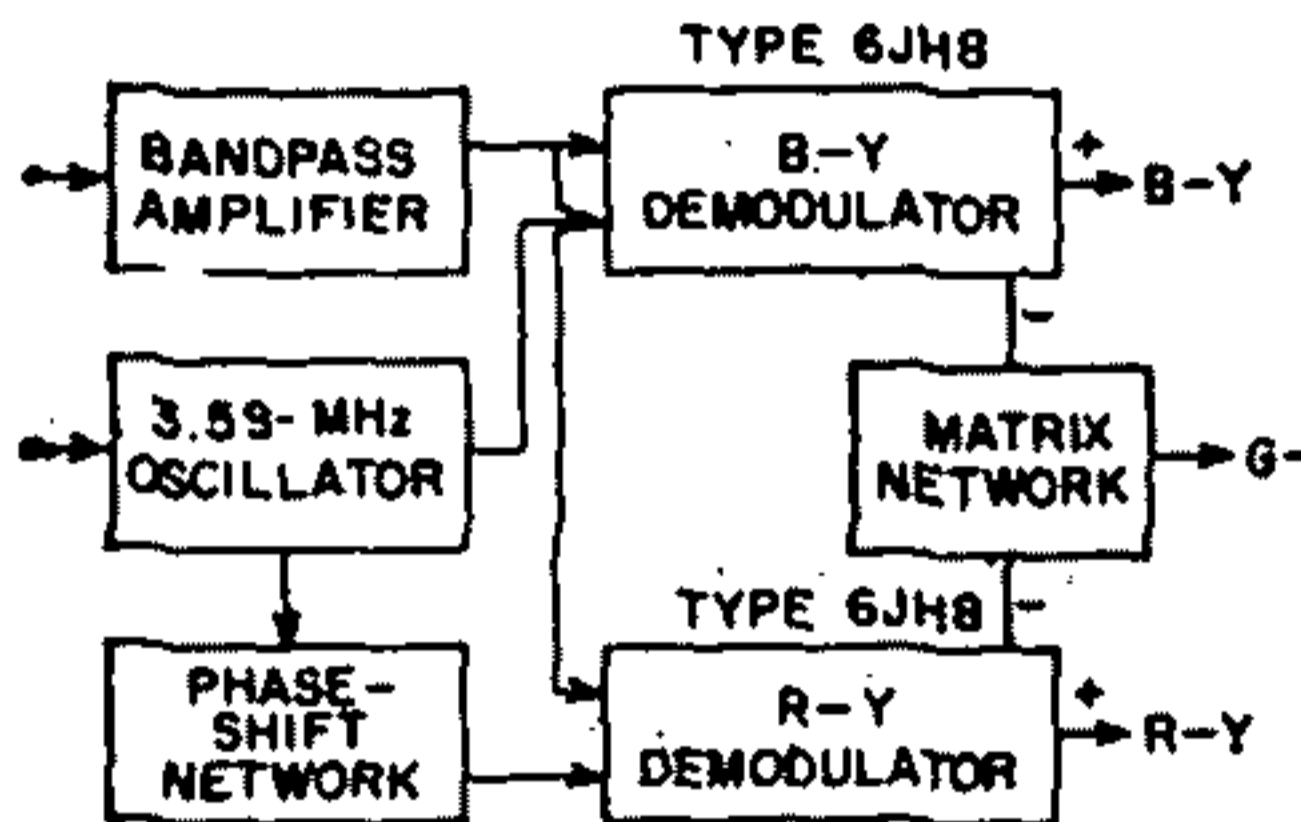


Fig. 97—Block diagram of demodulator circuit used to apply signals directly to color picture tube.

tors produce both positive and negative B-Y and R-Y signals. The positive signals are applied directly to the control grids (grid No. 1) of the blue and red guns of the color picture tube. At the same time, the negative color-difference signals are added (matrixed) in the correct proportions to produce the G-Y signal, which is applied to grid No. 1 of the green gun.

### Oscillation

As an oscillator, an electron tube can be employed to generate a continuously alternating voltage. In present-day radio broadcast receivers, this application is limited practically to superheterodyne receivers for supplying the heterodyning frequency. Several circuits (represented in Figs. 98 and 99) may be utilized, but they all depend on feeding more energy from the plate cir-

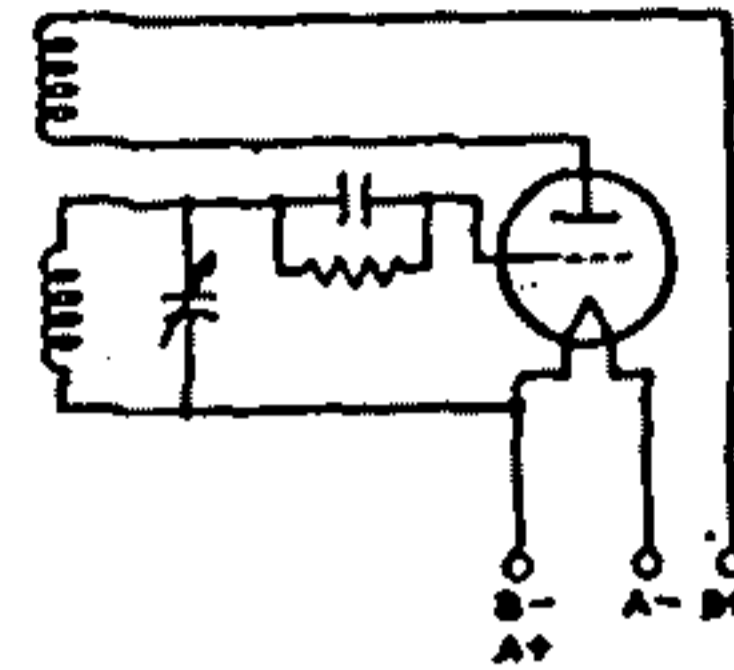


Fig. 98—Tuned-grid triode oscillator circuit using filament-type tube.

cuit to the grid circuit than is required to equal the power loss in the grid circuit. Feedback may be produced by electrostatic or electromagnetic coupling between the grid and plate circuits. When sufficient energy is fed back to more than compensate for the loss in the grid circuit, the tube will oscillate. The action consists of regular surges of power between the plate and the grid circuit at a frequency dependent on the circuit constants of inductance and capacitance. By proper choice of these values, the frequency may be adjusted over a very wide range.

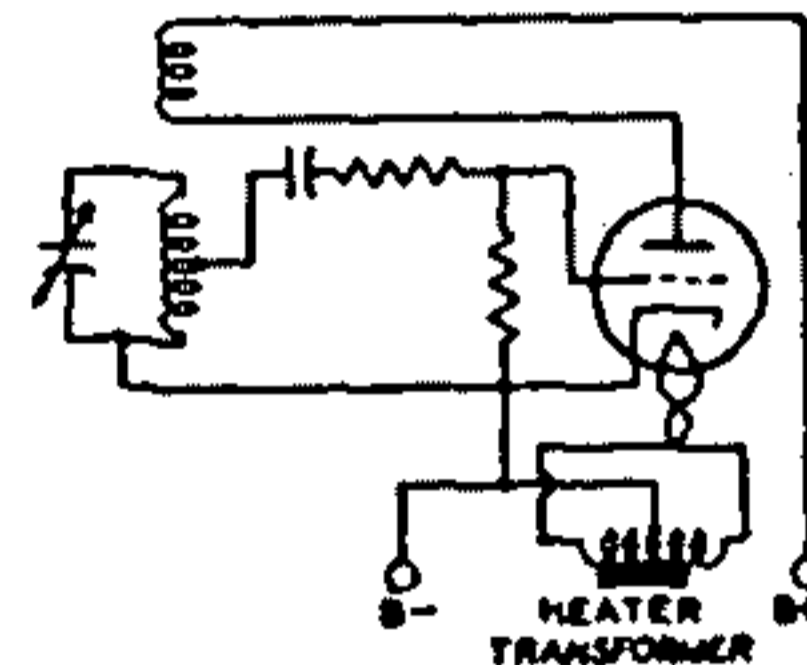


Fig. 99—Tuned-grid triode oscillator circuit using heater-cathode-type tube.

### Multivibrators

Relaxation oscillators, which are widely used in present-day electronic equipment, are used to produce non-sinusoidal waveshapes such as rectangular and sawtooth pulses. Probably the most common relaxation oscillator is the multivibrator, which may be considered as a two-stage resistance-coupled amplifier in which the output of each tube is coupled into the input of the other tube.

Fig. 100 is a basic multivibrator circuit of the free-running type. In this circuit, oscillations are maintained by the alternate shifting of conduction from

one tube to the other. The cycle usually starts with one tube,  $V_1$ , at zero bias, and the other,  $V_2$ , at cutoff or beyond. At this point, the capacitor  $C_1$  is charged sufficiently to cut off  $V_2$ .  $C_1$  then begins to discharge through the resistor  $R_4$ , and the voltage on the grid of  $V_2$  rises until  $V_2$  begins to conduct. The voltage on the plate of  $V_2$  then decreases, causing  $V_1$  to conduct less and less. At the same time, the plate voltage of  $V_1$  begins to rise, causing  $V_1$  to conduct still more heavily. Because of the amplification, this cumulative effect builds up extremely fast, and conduction switches from  $V_1$  to  $V_2$

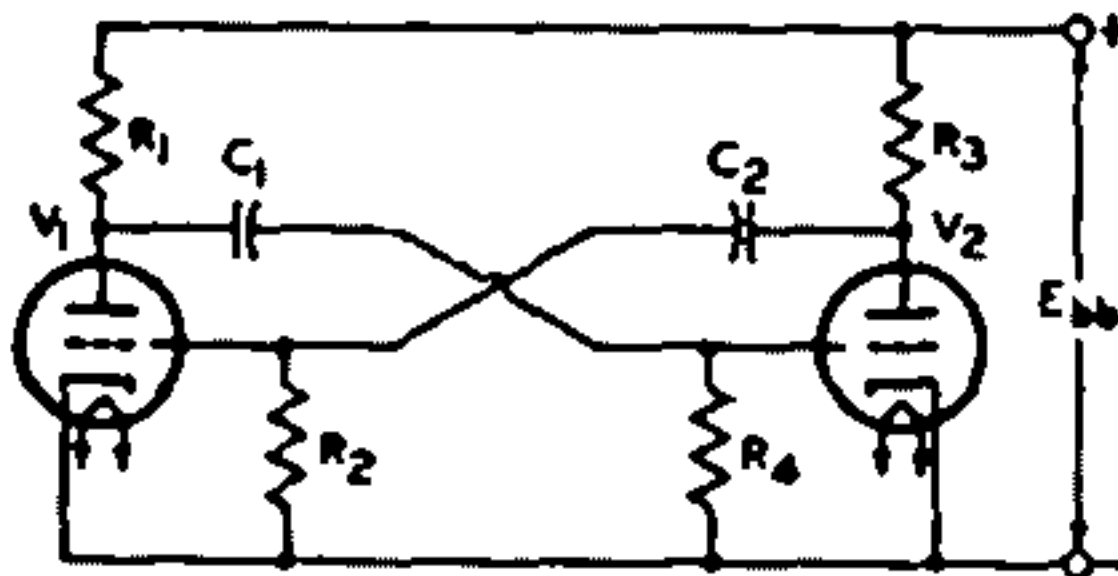


Fig. 100—Basic multivibrator circuit of the free-running type.

within a few microseconds, depending on the circuit components.

In this circuit, therefore, conduction switches from  $V_1$  to  $V_2$  over the interval during which  $C_1$  discharges from the voltage across  $R_4$  to the cutoff voltage for  $V_2$ . The actual transfer of conduction does not occur until cutoff is reached. Conduction switches back to  $V_1$  through a similar process to complete the cycle. The plate waveform is essentially rectangular in shape, and may be adjusted as to symmetry, frequency, and amplitude by proper choice of circuit constants, tubes, and voltages.

Although this type of multivibrator is free-running, it may be triggered by pulses of a given amplitude and frequency to provide a frequency-stabilized output. Multivibrator circuits may also be designed so that they are not free-running, but must be triggered externally to shift conduction from one tube to the other. Depending on the type of circuit, conduction may shift back to the first tube after a given time interval, or the second tube may continue conducting until another trigger signal is applied.

### Synchroguide Circuits

The "synchroguide" is a controlled type of oscillator used in television receivers to generate and control the synchronized sawtooth voltage necessary for adequate line- or horizontal-frequency scanning. A simplified synchroguide circuit is shown in Fig. 101. This circuit provides stable, noise-free control of a blocking oscillator which generates a horizontal-frequency signal. It permits comparison of the received sync pulses and the generated sawtooth voltages so that properly locked-in horizontal scanning results.

The triode  $V_1$  in Fig. 101 is a conventional blocking oscillator which enables a sawtooth voltage to be developed across the capacitor  $C_1$ . A portion of this sawtooth is fed back to the grid of

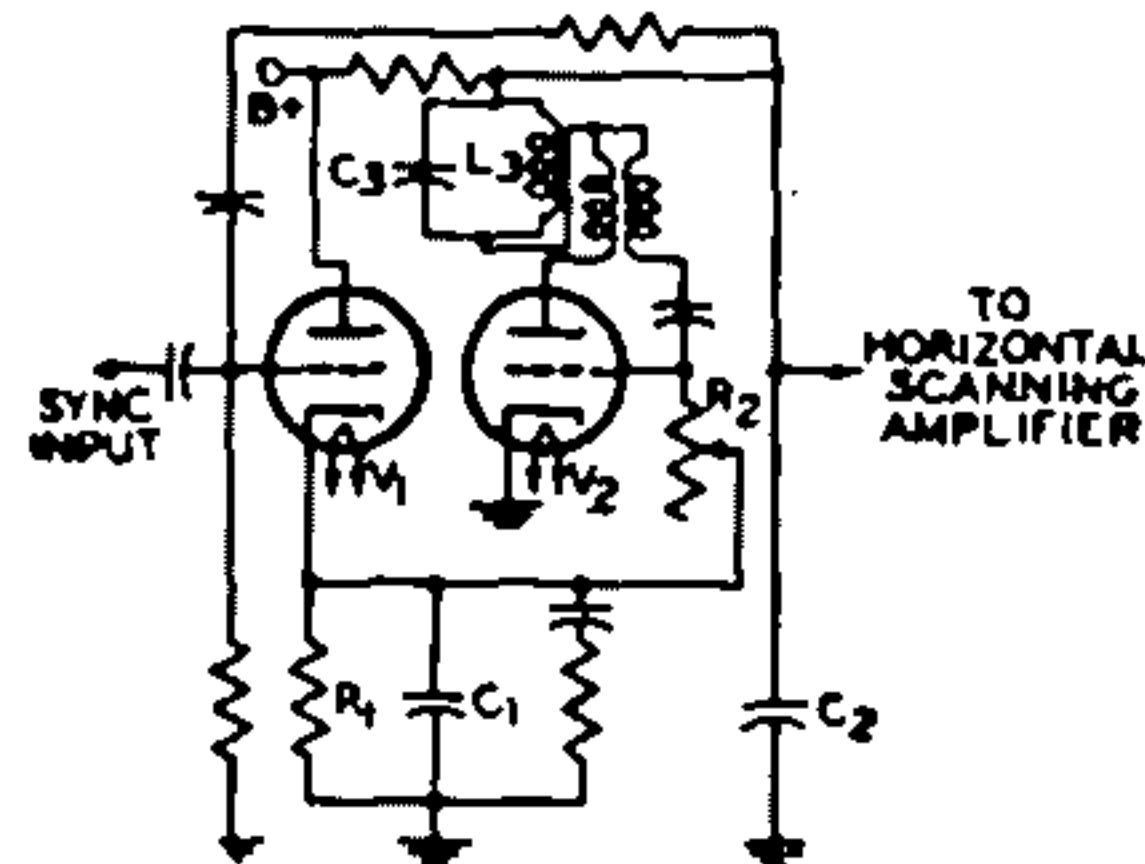


Fig. 101—Simplified synchroguide circuit.

the control tube,  $V_1$ . The positive sync pulses are also applied to the grid of  $V_1$ . The waveforms shown in Fig. 102 illustrate the sawtooth and sync pulses (A and B) and their proper "in-sync"

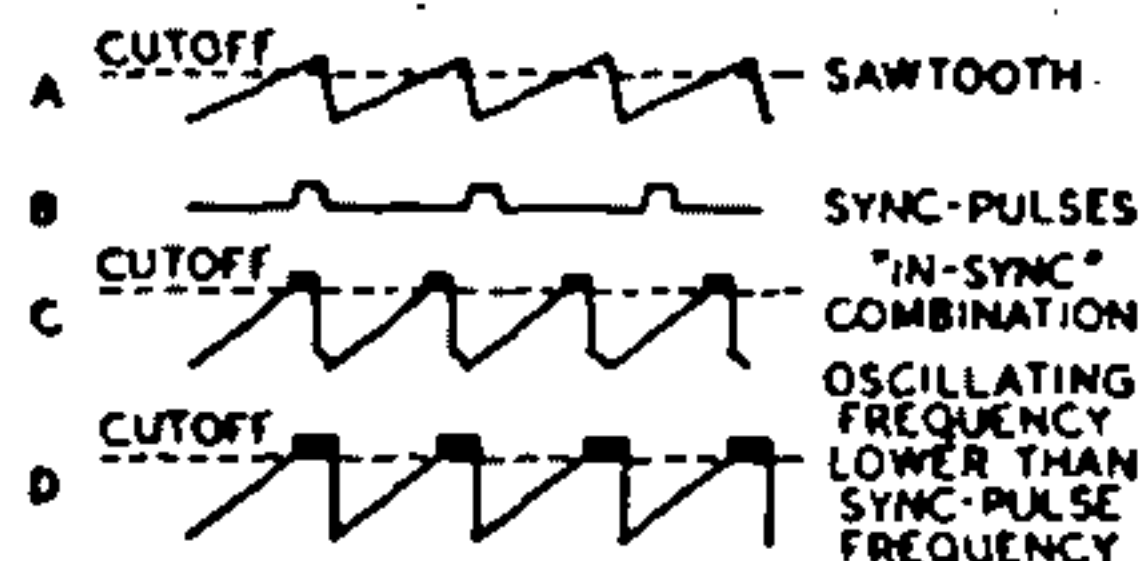


Fig. 102—Sawtooth and sync pulses in synchroguide circuit.

combination (C). The sync pulse occurs partly during the portion of the sawtooth voltage in which the triode  $V_1$  draws current. Any shift in sync pulse as it is superimposed on the sawtooth,



therefore, will affect the amount of conduction of the control tube. A change in control-tube conduction ultimately affects the bias on the oscillator-tube grid by changing the voltage to which the capacitor  $C_1$  in the cathode circuit may charge. An increase in the positive bias increases the frequency of oscillation.

For example, waveform D in Fig. 102 illustrates a condition in which the sawtooth voltage is advanced in phase with respect to the sync pulses. The widening of the pulse which occurs at the corner of the sawtooth waveform allows the control tube to conduct more current and, consequently, allows the capacitor  $C_1$  to charge to a higher voltage. This increased reference voltage also appears in the grid circuit of  $V_1$  and makes the grid more positive. The increased grid voltage then speeds up the frequency of oscillations until proper synchronization results.

The blocking oscillator can be made more immune to changes in frequency and noise if  $V_2$  is brought out of cutoff very sharply. This effect is obtained by sine-wave stabilization. The tuned circuit  $L_2C_2$  in the plate circuit of Fig. 101 superimposes a shock-excited sine wave on the plate and grid waveforms, as shown in Fig. 103.

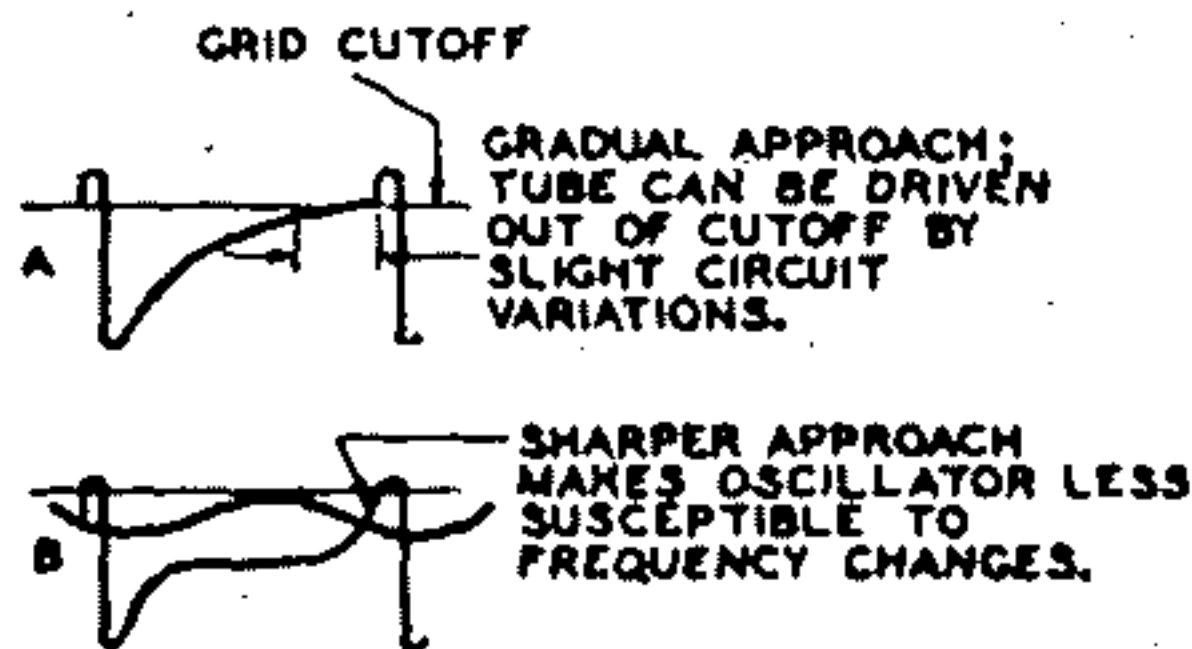


Fig. 103—Waveforms showing effect of tuned circuit  $L_2C_2$  in Fig. 101.

#### Automatic Frequency Control

An automatic frequency control (afc) circuit provides a means of correcting automatically the intermediate frequency of a superheterodyne receiver when, for any reason, it drifts from the frequency to which the if stages are tuned. This correction is made by adjusting the frequency of the oscillator.

Such a circuit will automatically compensate for slight changes in rf carrier or oscillator frequency as well as for inaccurate manual or push-button tuning.

An afc system requires two sections: a frequency detector and a variable reactance. The detector section may be essentially the same as the FM detector illustrated in Fig. 30 and discussed under **Detection**. In the afc system, however, the output is a dc control voltage, the magnitude of which is proportional to the amount of frequency shift. This dc control voltage is used to control the grid bias of an electron tube which comprises the variable reactance section (Fig. 104).

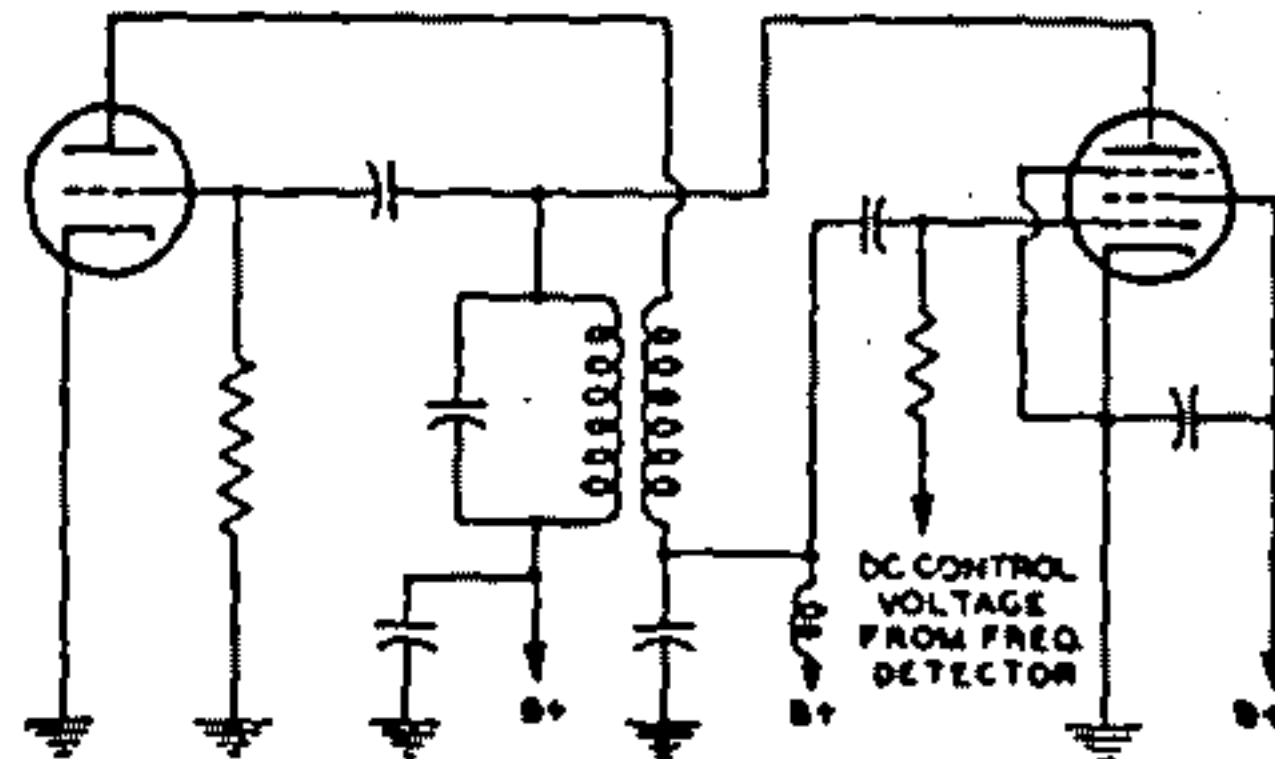


Fig. 104—Automatic-frequency-control (afc) circuit.

The plate current of the reactance tube is shunted across the oscillator tank circuit. Because the plate current and plate voltage of the reactance tube are almost 90 degrees out of phase, the control tube affects the tank circuit in the same manner as a reactance. The grid bias of the tube determines the magnitude of the effective reactance and, consequently, a control of this grid bias can be used to control the oscillator frequency.

Automatic frequency control is also used in television receivers to keep the horizontal oscillator in step with the horizontal-scanning frequency (15,750 Hz) at the transmitter. A widely used horizontal afc circuit is shown in Fig. 105. This circuit, which is often referred to as a **balanced-phase-detector** or **phase-discriminator** circuit, is usually employed to control the frequency of a multivibrator-type horizontal-oscillator circuit. The 6AL5 detector supplies

a dc control voltage to the grid of the horizontal-oscillator tube which counteracts changes in its operating frequency. The magnitude and polarity of the control voltages are determined by phase relationships in the afc circuit at a given moment.

The horizontal sync pulses obtained from the sync-separator circuit are fed through a single-triode phase-inverter or phase-splitter circuit to the two diode units of the 6AL5. Because of the action of the phase-inverter circuit, the signals applied to the two diode units are equal in amplitude but 180 degrees out of

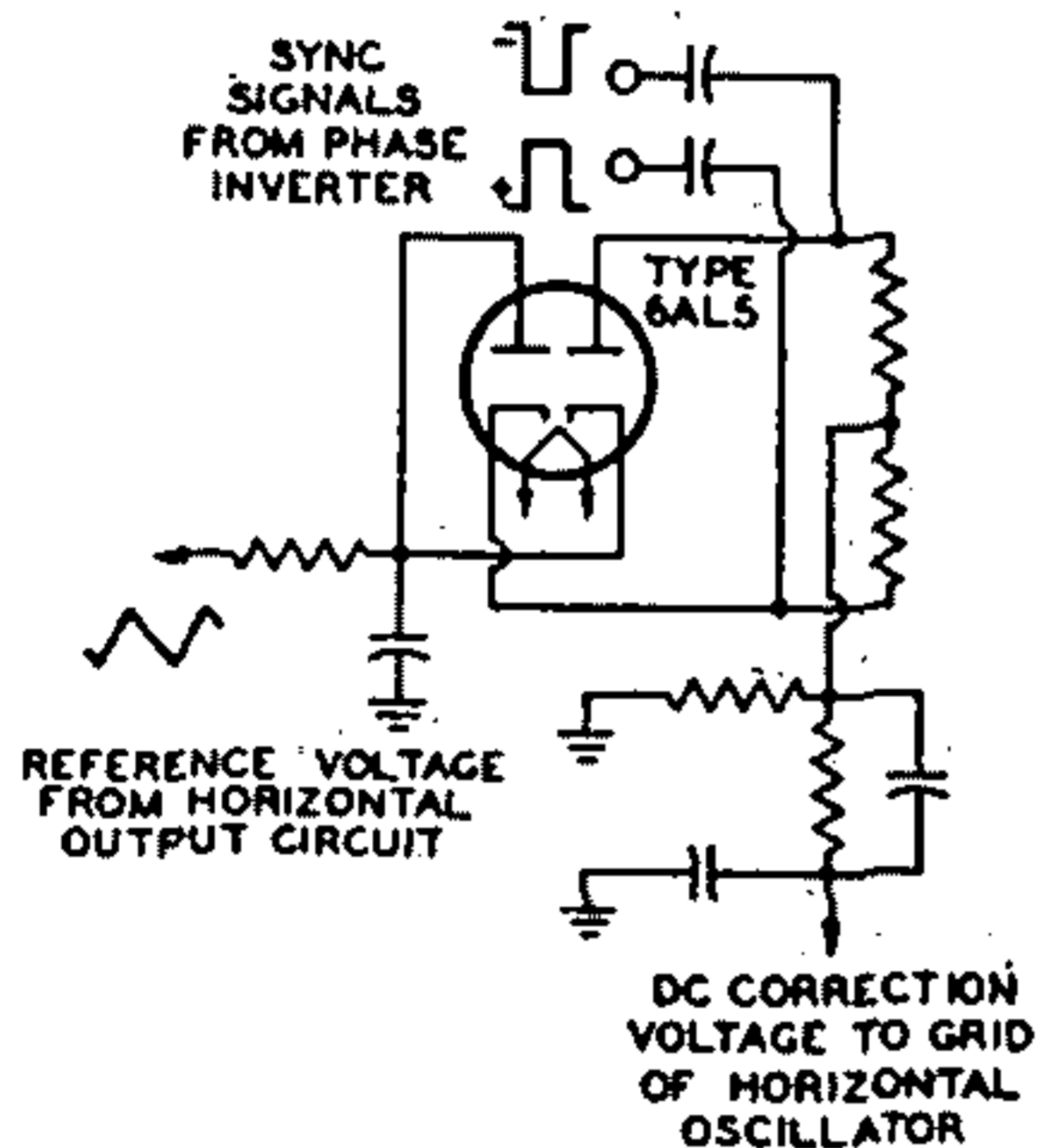


Fig. 105—Balanced phase-detector or phase-discriminator circuit for horizontal afc.

phase. A reference sawtooth voltage obtained from the horizontal output circuit is also applied simultaneously to both units. Any change in the oscillator frequency alters the phase relationship between the reference sawtooth and the incoming horizontal sync pulses, causing one diode unit of the 6AL5 to conduct more heavily than the other, and thus producing a correction signal. The system remains balanced at all times, therefore, because momentary changes in oscillator frequency are instantaneously corrected by the action of the control voltage.

The diode units of the 6AL5 are biased so that conduction takes place only during the tips of the sync pulses. The relative position of the sync pulses on the retrace portion of the sawtooth

waveform at any given instant determines which diode unit conducts more heavily, and thereby establishes the magnitude and polarity of the control voltage. The network between the diode units and the grid of the horizontal-oscillator tube is essentially a low-pass filter which prevents the horizontal sync pulses from affecting the horizontal-oscillator performance.

## Frequency Conversion

Frequency conversion is used in superheterodyne receivers to change the frequency of the rf signal to an intermediate frequency. To perform this change in frequency, a frequency-converting device consisting of an oscillator and a frequency mixer is employed. In such a device, shown diagrammatically in Fig. 106, two voltages of different frequency, the rf signal voltage and the voltage generated by the oscillator, are applied to the input of the frequency mixer. These voltages beat, or heterodyne, within the mixer tube to produce a plate current having, in addition to the frequencies of the input voltages, numerous sum and difference frequencies.

The output circuit of the mixer stage is provided with a tuned circuit which is adjusted to select only one beat frequency, *i.e.*, the frequency equal to the difference between the signal frequency and the oscillator frequency. The selected output frequency is known

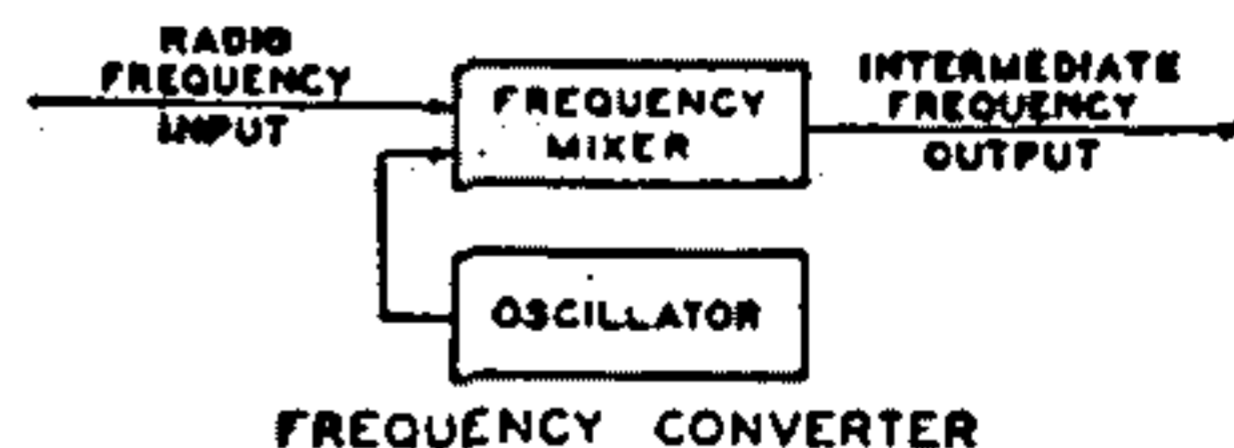


Fig. 106—Block diagram of simple frequency-converter circuit.

as the intermediate frequency, or if. The output frequency of the mixer tube is kept constant for all values of signal frequency by tuning the oscillator to the proper frequency.

Important advantages gained in a receiver by the conversion of signal frequency to a fixed intermediate frequency



are high selectivity with few tuning stages and a high, as well as stable, overall gain for the receiver.

Several methods of frequency conversion for superheterodyne receivers are of interest. These methods are alike in that they employ a frequency-mixer tube in which plate current is varied at a combination frequency of the signal frequency and the oscillator frequency. These variations in plate current produce across the tuned plate load a voltage of the desired intermediate frequency. The methods differ in the types of tubes employed and in the means of supply input voltages to the mixer tube.

A method widely used before the availability of tubes especially designed for frequency-conversion service, and currently used in many FM, television, and standard broadcast receivers, employs as mixer tube either a triode, a tetrode, or a pentode, in which oscillator voltage and signal voltage are applied to the same grid. In this method, coupling between the oscillator and mixer circuits is obtained by means of inductance or capacitance.

A second method employs a tube having an oscillator and frequency mixer combined in the same envelope. In one form of such a tube, coupling between the two units is obtained by means of the electron stream within the tube. Because five grids are used, the tube is called a pentagrid converter.

Grids No. 1 and No. 2 and the cathode are connected to an external circuit to act as a triode oscillator. Grid No. 1 is the grid of the oscillator and Grid No. 2 is the anode. These and the cathode can be considered as a composite cathode which supplies to the rest of the tube an electron stream that varies at the oscillator frequency.

This varying electron stream is further controlled by the rf signal voltage on grid No. 4. Thus, the variations in plate current are due to the combination of the oscillator and the signal frequencies. The purpose of grids No. 3 and No. 5, which are connected together within the tube, is to accelerate the electron stream and to shield grid No. 4 electrostatically from the other electrodes.

Pentagrid-converter tubes of this design are good frequency-converting devices at medium frequencies. However, their performance is better at the lower frequencies because the output of the oscillator drops off as the frequency is raised and because certain undesirable effects produced by interaction between oscillator and signal sections of the tube increase with frequency.

To minimize these effects, several of the pentagrid-converter tubes are designed so that no electrode functions alone as the oscillator anode. In these tubes, grid No. 1 functions as the oscillator grid, and grid No. 2 is connected within the tube to the screen grid (grid No. 4). The combined two grids, Nos. 2 and 4, shield the signal grid (grid No. 3) and act as the composite anode of the oscillator triode. Grid No. 5 acts as the suppressor grid.

Converter tubes of this type are designed so that the space charge around the cathode is unaffected by electrons from the signal grid. Furthermore, the electrostatic field of the signal grid also has little effect on the space charge. The result is that rf voltage on the signal grid produces little effect on the cathode current. There is, therefore, little detuning of the oscillator by AVC bias because changes in AVC bias produce little change in oscillator transconductance or in the input capacitance of grid No. 1.

Examples of the pentagrid converters discussed in the preceding paragraph are the single-ended types 1R5 and 6BE6. A schematic diagram illustrating the use of the 6BE6 with self-excitation is given in Fig. 107. The 6BE6 may also be used with separate excitation. A complete circuit is shown in the **Circuits** section.

Another method of frequency conversion utilizes a separate oscillator having its grid connected to the No. 1 grid of a mixer hexode. The cathode, triode grid, and triode plate form the oscillator unit of the tube. The cathode, hexode mixer grid (grid No. 1), hexode screen grids (grids Nos. 2 and 4), hexode signal grid (grid No. 3), and hexode plate constitute the mixer unit. The internal

shields are connected to the shell of the tube and act as a suppressor grid for the hexode unit.

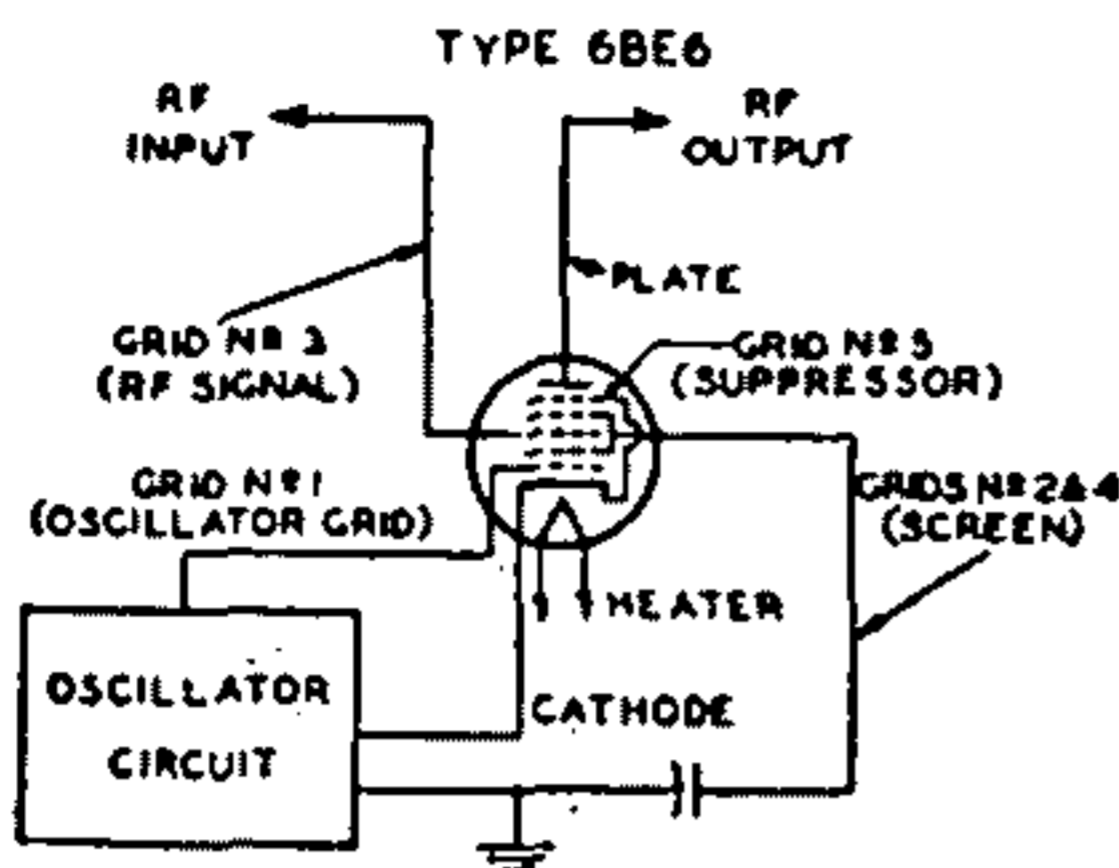


Fig. 107—Frequency-converter circuit using the 6BE6 pentagrid converter with self-excitation.

The action of this tube in converting a radio-frequency signal to an intermediate frequency depends on (1) the generation of a local frequency by the triode unit, (2) the transferring of this frequency to the hexode grid No. 1, and (3) the mixing in the hexode unit of this frequency with that of the rf signal applied to the hexode grid No. 3. The tube is not critical to changes in oscillator-plate voltage or signal-grid bias and, therefore, finds important use in all-wave receivers to minimize frequency-shift effects at the higher frequencies.

A further method of frequency conversion employs a tube called a pentagrid mixer. This type has two independent control grids and is used with a separate oscillator tube. RF signal voltage is applied to one of the control grids and oscillator voltage is applied to the other. It follows, therefore, that the variations in plate current are due to the combination of the oscillator and signal frequencies.

The tube contains a heater-cathode, five grids, and a plate. Grids Nos. 1 and 3 are control grids. The rf signal voltage is applied to grid No. 1. This grid has a remote-cutoff characteristic and is suited for control by avc bias voltage. The oscillator voltage is applied to grid No. 3. This grid has a sharp-cutoff characteristic and produces a comparatively large effect on plate current for a small amount of oscillator voltage. Grids Nos. 2 and 4 are connected together within

the tube. They accelerate the electron stream and shield grid No. 3 electrostatically from the other electrodes. Grid No. 5, connected within the tube to the cathode, functions similarly to the suppressor grid in a pentode.

In the converter or mixer stage of a television receiver, stable oscillator operation is most readily obtained when separate tubes or tube sections are used for the oscillator and mixer functions. A typical television mixer-oscillator circuit is shown in Fig. 108. In such circuits, the oscillator voltage is applied to the mixer grid by inductive coupling, capacitive coupling, or a combination of the two. Tubes containing electrically independent oscillator and mixer units in the same envelope, such as the 6U8A and 6X8, are designed especially for this application.

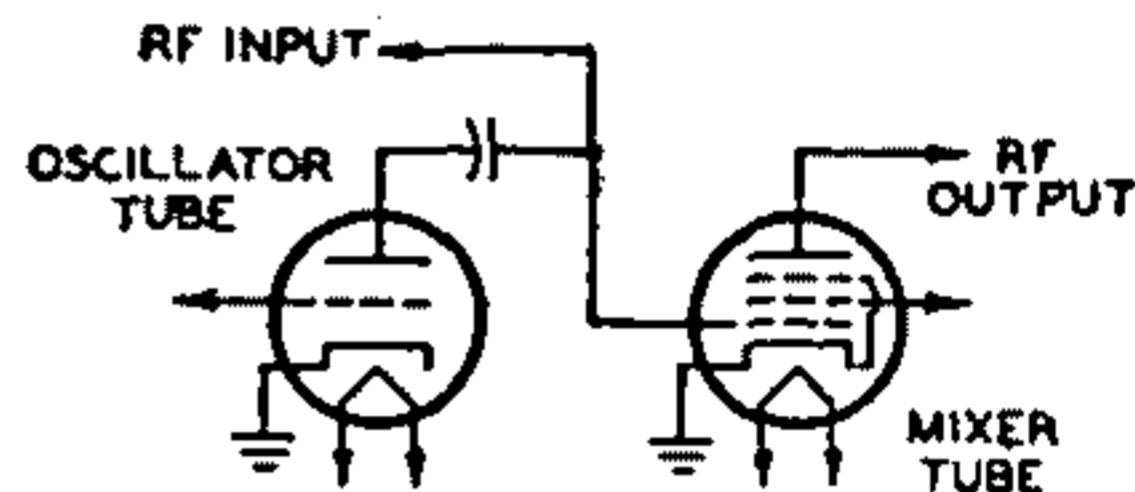


Fig. 108—Typical television mixer-oscillator circuit.

### Tuning Indication With Electron-Ray Tubes

Electron-ray tubes are designed to indicate visually by means of a fluorescent target the effects of a change in controlling voltage. One application of them is as tuning indicators in radio receivers. Types such as the 6U5, 6E5, and the 6AB5/6N5 contain two main parts: (1) a triode which operates as a dc amplifier and (2) an electron-ray indicator which is located in the bulb as shown in Fig. 109. The target is operated at a positive voltage and, therefore, attracts electrons from the cathode. When the electrons strike the target they produce a glow on the fluorescent coating of the target. Under these conditions, the target appears as a ring of light.

A ray-control electrode is mounted between the cathode and target. When the potential of this electrode is less positive than the target, electrons flow-



ing to the target are repelled by the electrostatic field of the electrode, and do not reach that portion of the target behind the electrode. Because the target does not glow where it is shielded from electrons, the control electrode casts a

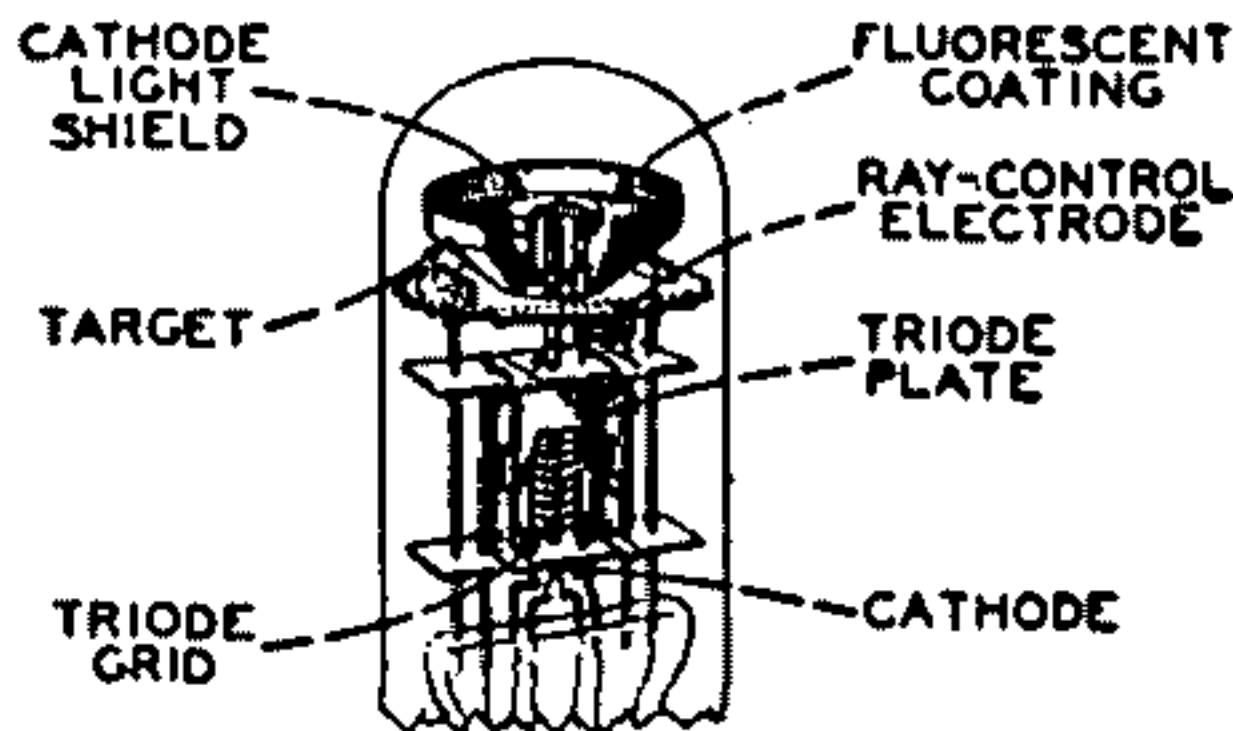


Fig. 109—Structure of electron-ray tube.

shadow on the glowing target. The extent of this shadow varies from approximately 100 degrees of the target when the control electrode is much more negative than the target to 0 degrees when the control electrode is at approximately the same potential as the target.

In the application of the electron-ray tube, the potential of the control electrode is determined by the voltage on the grid of the triode section, as can be seen in Fig. 110. The flow of the triode plate current through resistor R produces a voltage drop which de-

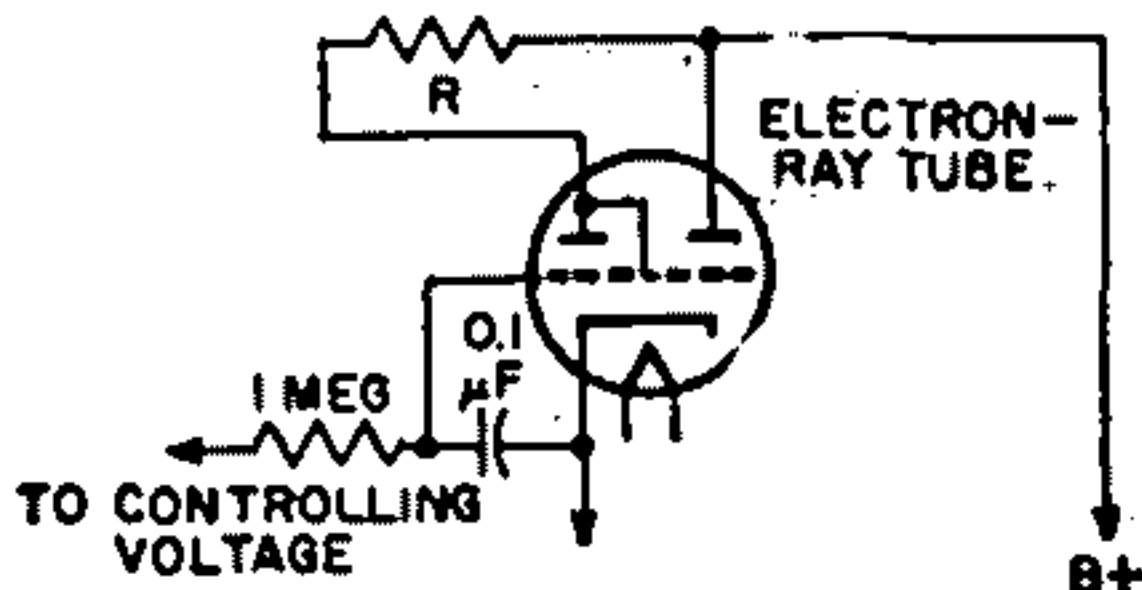


Fig. 110—Indicating circuit using an electron-ray tube.

termines the potential of the control electrode. When the voltage of the triode grid changes in the positive direction, plate current increases, the potential of the control electrode goes down because of the increased drop across R, and the

shadow angle widens. When the potential of the triode grid changes in the negative direction, the shadow angle narrows.

Another type of indicator tube is the 6AF6G. This tube contains only an indicator unit but employs two ray-control electrodes mounted on opposite sides of the cathode and connected to individual base pins. It employs an external dc amplifier. (See Fig. 111.) Thus, two symmetrically opposite shadow angles may be obtained by connecting the two ray-control electrodes together; or, two unlike patterns may be obtained by individual connection of each ray-control electrode to its respective amplifier.

In radio receivers, avc voltage is applied to the grid of the dc amplifier.

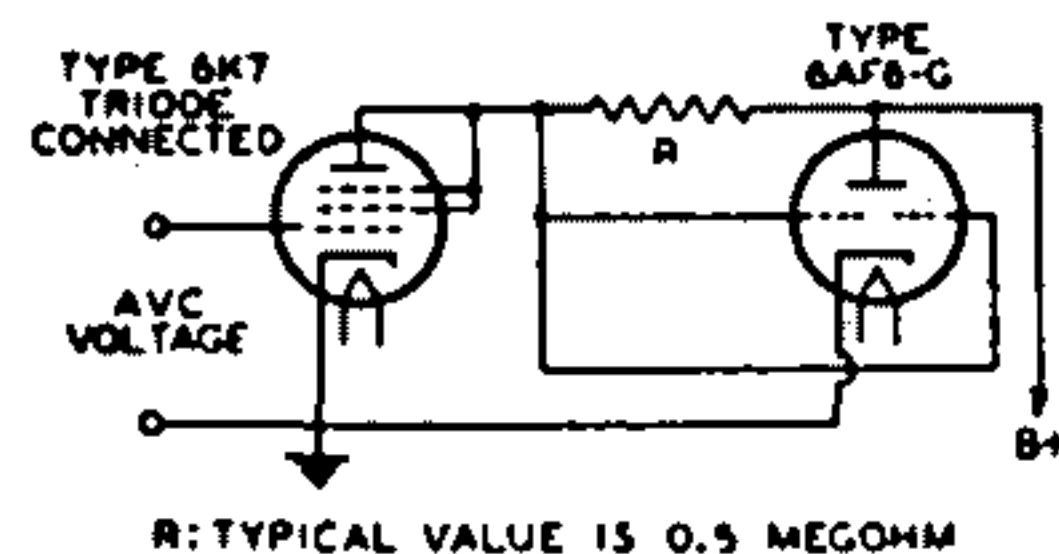


Fig. 111—Indicating circuit using 6AF6G electron-ray tube and external dc amplifier.

Because avc voltage is at maximum when the set is tuned to give maximum response to a station, the shadow angle is at minimum when the receiver is tuned to resonance with the desired station.

The choice between electron-ray tubes depends on the avc characteristic of the receiver. The 6E5 contains a sharp-cutoff triode which closes the shadow angle on a comparatively low value of avc voltage. The 6AB5/6N5 and 6U5 each have a remote-cutoff triode which closes the shadow on a larger value of avc voltage than the 6E5. The 6AF6G may be used in conjunction with dc amplifier tubes having either remote- or sharp-cutoff characteristics.

# Electron Tube Installation

**T**HE installation of electron tubes requires care if high-quality performance is to be obtained from the associated circuits. Installation suggestions and precautions which are generally common to all types of tubes are covered in this section. Careful observance of these suggestions will do much to help the experimenter and electronic technician obtain the full performance capabilities of radio tubes and circuits. Additional pertinent information is given under each tube type and in the **Circuits** section.

## Filament and Heater Power Supply

The design of electron tubes allows for some variation in the voltage and current supplied to the filament or heater, but most satisfactory results are obtained from operation at the rated values. When the voltage is low, the temperature of the cathode is below normal, with the result that electron emission is limited. The limited emission may cause unsatisfactory operation and reduced tube life. On the other hand, high cathode voltage may cause rapid evaporation of cathode material and shorten tube life.

To insure proper tube operation, it is important that the filament or heater voltage be checked at the socket terminals by means of a high-resistance voltmeter while the equipment is in operation. In the case of series operation of heaters or filaments, correct adjustment can be checked by means of an ammeter in the heater or filament circuit.

The filament or heater voltage sup-

ply may be a direct-current source (a battery or a dc power line) or an alternating-current power line, depending on the type of service and type of tube. Frequently, a resistor (either variable or fixed) is used with a dc supply to permit compensation for battery voltage variations or to adjust the tube voltage at the socket terminals to the correct value. Ordinarily, a step-down transformer is used with an ac supply to provide the proper filament or heater voltage. Receivers intended for operation on both dc and ac power lines have the heaters connected in series with a suitable resistor and supplied directly from the power line.

**DC filament or heater operation** should be considered on the basis of the source of power. In the case of the battery supply for the 1.4-volt filament tubes, it is unnecessary to use a *voltage-dropping resistor in series* with the filament and a single dry-cell; the filaments of these tubes are designed to operate satisfactorily over the range of voltage variations that normally occur during the life of a dry-cell. Likewise, no series resistor is required when the 1.25-volt filament subminiatures are operated from a single 1.5-volt flashlight-type dry-cell, when the 2-volt filament-type tubes are operated from a single storage cell, or when the 6.3-volt series are operated from a 6-volt storage battery.

In the case of dry-battery supply for 2-volt filament tubes, a variable resistor in series with the filament and the battery is required to compensate for battery variations. Turning the set on and off by means of the rheostat is advised to prevent over-voltage conditions after an off-period because the



voltage of dry-cells rises during off periods.

In the case of storage-battery supply, air-cell-battery supply, or dc power supply, a non-adjustable resistor of suitable value may be used. It is well to check initial operating conditions, and thus the resistor value, by means of a voltmeter or ammeter.

**AC filament or heater operation** should be considered on the basis of either a parallel or a series arrangement of filaments and/or heaters. In the case of the parallel arrangements, a step-down transformer is employed. Precautions should be taken to see that the line voltage is the same as that for which the primary of the transformer is designed. The line voltage may be determined by measurement with an ac voltmeter (0-150 volts).

If the line voltage measures in excess of that for which the transformer is designed, a resistor should be placed in series with the primary to reduce the line voltage to the rated value of the transformer primary. Unless this is done, the excess input voltage will cause proportionally excessive voltage to be applied to the tubes. Any electron tube may be damaged or made inoperative by excessive operating voltages.

If the line voltage is consistently below that for which the primary of the transformer is designed, it may be necessary to install a booster transformer between the ac outlet and the transformer primary. Before such a transformer is installed, the ac line fluctuations should be very carefully noted. Some radio sets are equipped with a line-voltage switch which permits adjustment of the power transformer primary to the line voltage. When this switch is properly adjusted, the series-resistor or booster-transformer method of controlling line voltage is seldom required.

In the case of the series arrangements of filaments and/or heaters, a voltage-dropping resistance in series with the heaters and the supply line is usually required. This resistance should be of such value that, for normal line voltage, tubes will operate at their rated heater or filament current. The method

for calculating the resistor value is given below.

When the filaments of battery-type tubes are connected in series, the total filament current is the sum of the current due to the filament supply and the plate and grid-No. 2 currents (cathode current) returning to B(—) through the tube filaments. Consequently, in a series filament string it is necessary to add shunt resistors across each filament section to bypass this cathode current in order to maintain the filament voltage at its rated value.

The filament or heater resistor required when filaments and/or heaters are operated in parallel can be determined easily by a simple formula derived from Ohm's law.

$$\text{Required resistance (ohms)} = \frac{\text{supply volts} - \text{rated volts of tube type}}{\text{total rated filament current (amperes)}}$$

Thus, if a receiver using two 1T4's, one IR5, one IU5, and one 3V4 is to be operated from a storage battery, the series resistor is equal to 2 volts (the voltage from a single storage cell) minus 1.4 volts (voltage rating for these tubes) divided by 0.3 ampere (the sum of  $4 \times 0.05$  ampere +  $1 \times 0.1$  ampere), i.e., approximately 2 ohms. Because this resistor should be variable to allow adjustment for battery depreciation, it is advisable to obtain the next larger commercial size, although any value between 2 and 3 ohms will be quite satisfactory.

Where much power is dissipated in the resistor, the wattage rating should be sufficiently large to prevent overheating. The power dissipation in watts is equal to the voltage drop in the resistor multiplied by the total filament current in amperes. Thus, for the example above,  $0.6 \times 0.3 = 0.18$  watt. In this case, the value is so small that any commercial rheostat with suitable resistance will be adequate.

For the case where the heaters and/or filaments of several tubes are operated in series, the resistor value is calculated by the following formula, also derived from Ohm's law.

$$\text{Required resistance (ohms)} = \frac{\text{supply volts} - \text{total rated volts of tubes}}{\text{rated amperes of tubes}}$$

Thus, if a receiver having one 6BE6, one 6BA6, one 6AT6, one 25L6GT, and one 25Z6GT is to be operated from a 117-volt power line, the series resistor is equal to 117 volts (the supply voltage) minus 68.9 volts (the sum of  $3 \times 6.3$  volts +  $2 \times 25$  volts) divided by 0.3 ampere (current rating of these tubes), i.e., approximately 160 ohms. The wattage dissipation in the resistor will be 117 volts minus 68.9 volts times 0.3 ampere, or approximately 14.4 watts. A resistor having a wattage rating in excess of this value should be chosen.

When the series-heater connection is used in ac/dc receivers, it is usually advisable to arrange the heaters in the circuit so that the tubes most sensitive to hum disturbances are at or near the ground potential of the circuit. This arrangement reduces the amount of ac voltage between the heaters and cathodes of these tubes and minimizes the hum output of the receiver. The order of heater connection, by tube function, from chassis to the rectifier-cathode side of the ac line is shown in Fig. 112.

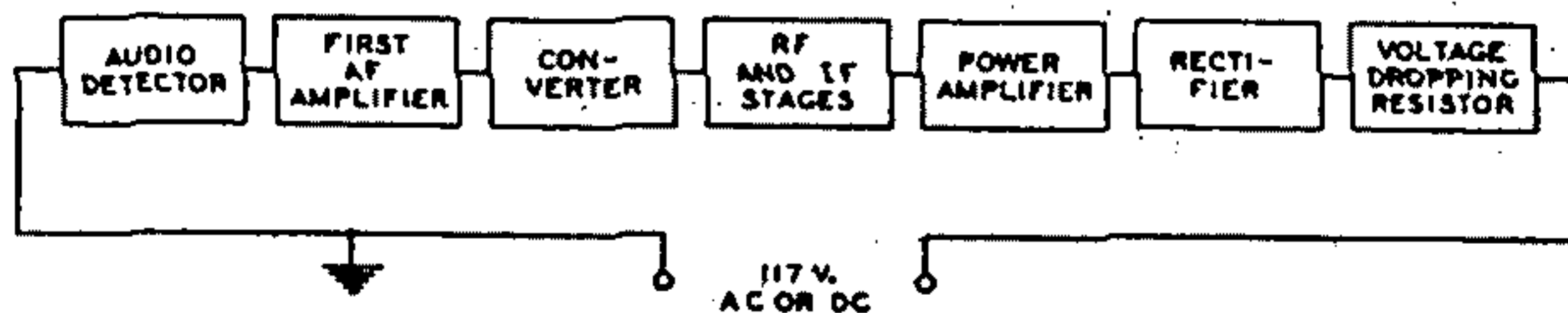


Fig. 112—Order of series heater-string connection, by tube function, to minimize hum.

### Heater-to-Cathode Connection

When heater-type tubes are operated from ac, their cathodes may be returned (through resistors, capacitors, or other components) to the mid-tap on the heater supply winding, to the mid-tap of a small resistor (about 50 ohms) connected across the winding, or to one end of the heater supply winding, depending on circuit requirements. In all circuits, it is important to keep the heater-cathode voltage within the maximum ratings specified for the tube.

Heater-type tubes may produce hum as a result of conduction between heater and cathode or between heater and control grid, or by modulation of

the electron stream by the alternating magnetic field surrounding the heater. When a large resistor is used between heater and cathode (as in series-connected heater strings), or when one side of the heater is grounded, even a minute pulsating leakage current between heater and cathode can develop a small voltage across the cathode-circuit impedance and cause objectionable hum. The use of a large cathode bypass capacitor is recommended to minimize this source of hum.

Much lower hum levels can be achieved when heaters are connected in parallel systems in which the center-tap of the heater supply is grounded or, preferably, connected to a positive bias source of 15 to 80 volts dc to reduce the flow of alternating current. The heater leads of the tubes should be twisted and kept away from high-impedance circuits. The balanced ac supply provides almost complete cancellation of the alternating-current components.

The balanced arrangement described above also minimizes heater-

grid hum. High grid-circuit impedances should be avoided, if possible. High heater voltages should also be avoided because heater-cathode hum rises sharply when the heater voltage is increased above the published value.

Certain tube types are designed especially to minimize hum in high-quality, high-fidelity audio equipment. Examples are the 5879, 7025, and 7199.

### Plate Voltage Supply

The plate voltage for electron tubes is obtained from batteries, rectifiers, direct-current power lines, and small local generators. The maximum plate-voltage value for any tube type should



not be exceeded if most satisfactory performance is to be obtained. Plate voltage should not be applied to a tube unless the corresponding recommended voltage is also supplied to the grid.

It is recommended that the primary circuit of the power transformer be fused to protect the rectifier tube(s), the power transformer, filter capacitor, and chokes in case a rectifier tube fails.

### Grid Voltage Supply

The recommended grid voltages for different operating conditions have been carefully determined to give the most satisfactory performance. Grid voltage may be obtained from a fixed source such as a separate C-battery or a tap on the voltage divider of the high-voltage dc supply, from the voltage drop across a resistor in the cathode circuit, or from the voltage drop across a resistor in the grid circuit. The first method is called "fixed bias"; the second is called "cathode bias" or "self bias"; the third is called "grid-resistor bias" and is sometimes incorrectly referred to in receiving-tube practice as "zero-bias operation."

In any case, the object is to make the grid negative with respect to the cathode by the specified voltage. When a C-battery is used, the negative terminal is connected to the grid return and the positive terminal is connected to the negative filament socket terminal, or to the cathode terminal if the tube is of the heater-cathode type. If the filament is supplied with alternating current, this connection is usually made to the center-tap of a low resistance (20 to 50 ohms) shunted across the filament ter-

minals. This method reduces hum disturbances caused by the ac supply. If bias voltages are obtained from the voltage divider of a high-voltage dc supply, the grid return is connected to a more negative tap than the cathode.

The **cathode-biasing** method utilizes the voltage drop produced by the cathode current flowing through a resistor connected between the cathode and the negative terminal of the B-supply. (See Fig. 113.) The cathode current is, of course, equal to the plate current in the case of a triode, or to the sum of the plate and grid-No. 2 currents in the case of a tetrode, pentode, or beam power tube. Because the voltage drop along the resistance is increasingly negative with respect to the cathode, the required negative grid-bias voltage can be obtained by connecting the grid return to the negative end of the resistance.

The value of the resistance for cathode-biasing a single tube can be determined from the following formula:

$$\text{Resistance (ohms)} = \frac{\text{desired grid-bias voltage} \times 1000}{\text{rated cathode current in milliamperes}}$$

Thus, the resistance required to produce 9 volts bias for a triode which operates at 3 milliamperes plate current is  $9 \times 1000/3 = 3000$  ohms. If the cathode current of more than one tube passes through the resistor, or if the tube or tubes employ more than three electrodes, the total current determines the size of the resistor.

**Bypassing** of the cathode-bias resistor depends on circuit-design requirements. In rf circuits the cathode resistor usually is bypassed. In af circuits the use of an unbypassed resistor will re-

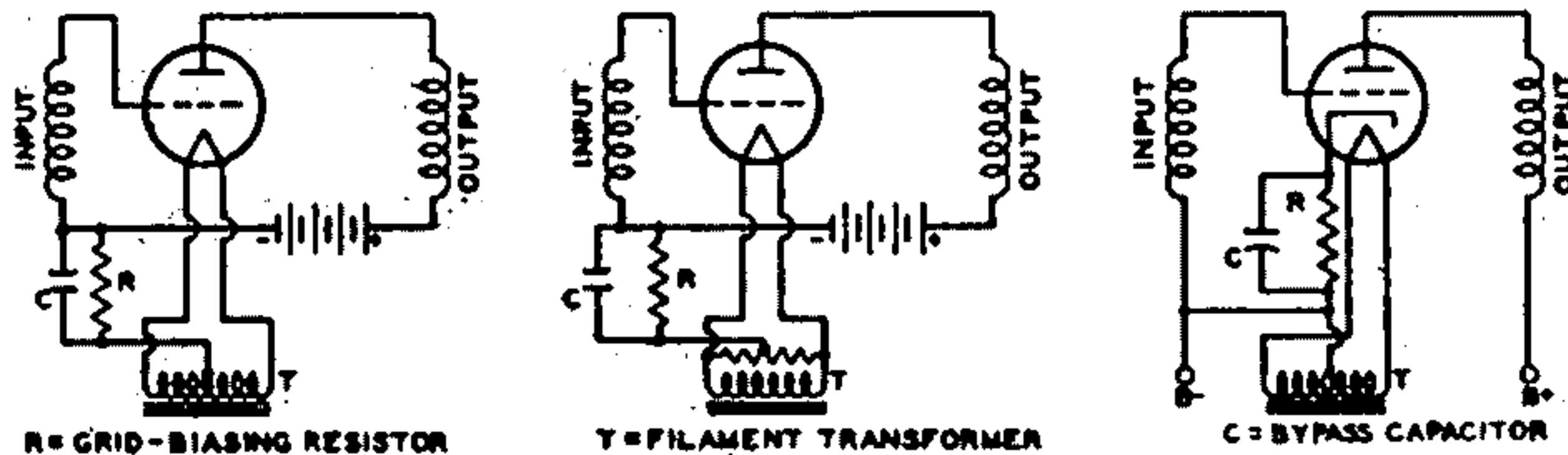


Fig. 113—Typical grid-voltage supply circuits.

duce distortion by introducing degeneration into the circuit. However, the use of an unbypassed resistor decreases gain and power sensitivity. When bypassing is used, it is important that the bypass capacitor be sufficiently large to have negligible reactance at the lowest frequency to be amplified.

In the case of power-output tubes having high transconductance, such as beam power tubes, it may be necessary to shunt the bias resistor with a small mica capacitor (approximately 0.001 $\mu$ F) in order to prevent oscillations. The usual af bypass may or may not be used, depending on whether or not degeneration is desired. In tubes having high values of transconductance, such as the 6BA6, 6CB6, and 6AC7, input capacitance and input conductance change appreciably with plate current. When such a tube having a separate suppressor-grid connection is used as an rf amplifier, these changes may be minimized by leaving a certain portion of the cathode-bias resistor unbypassed. In order to minimize feedback when this method is used, the external grid-No. 1-to-plate (wiring) capacitances should be kept to a minimum, the grid No. 2 should be bypassed to ac ground, and the grid No. 3 should be connected to ac ground.

The use of a cathode resistor to obtain bias voltage is not recommended for amplifiers in which there is appreciable shift of electrode currents with the application of a signal. In such amplifiers, a separate fixed supply is recommended.

The **grid-resistor biasing** method is also a self-bias method because it utilizes the voltage drop across the grid resistor produced by small amounts of grid current flowing in the grid-cathode circuit. This current is due to (1) an electromotive potential difference between the materials comprising the grid and cathode and (2) grid rectification when the grid is driven positive. A large value of resistance is required in order to limit this current to a very small value and to avoid undesirable loading effects on the preceding stage.

Examples of this method of bias are given in the **Circuits** section. In

these circuits, the audio amplifier type 1U5 or 12AV6 has a 10-megohm resistor between the grid and the negative filament or cathode to furnish the required bias, which is usually less than 1 volt. This method of biasing is used principally in the early voltage-amplifier stages (usually employing high- $\mu$  triodes) of audio amplifier circuits, where the tube dissipation will not be excessive under zero-signal conditions.

A grid resistor is also used in many oscillator circuits for obtaining the required bias. In these circuits, the grid voltage is relatively constant and its magnitude is usually in the order of 5 volts or more. Consequently, the bias voltage is obtained only through grid rectification. A relatively low value of resistor, 0.1 megohm or less, is used. Oscillator circuits employing this method of bias are given in the **Circuits** section.

**Grid-bias variation** for the rf and if amplifier stages is a convenient and frequently used method for controlling receiver volume. The variable voltage supplied to the grid may be obtained: (1) from a variable cathode resistor as shown in Figs. 114 and 115; (2) from a bleeder circuit by means of a potentiometer as shown in Fig. 116; or (3) from a bleeder circuit in which the bleeder current is varied by a tube

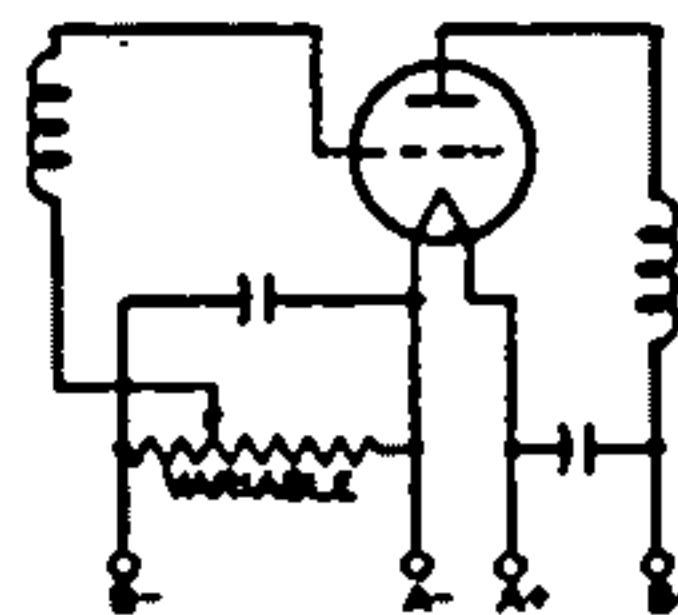


Fig. 114—Amplifier stage using a variable cathode-bias resistor for volume control.

used for automatic volume control. The latter circuit is shown in Fig 61.

In all cases it is important that the control be arranged so that at no time will the bias be less than the recommended minimum grid-bias voltage for the particular tubes used. This requirement can be met by providing a fixed stop on the potentiometer, by



connecting a fixed resistance in series with the variable resistance, or by connecting a fixed cathode resistance in series with the variable resistance used for regulation. Where receiver gain is

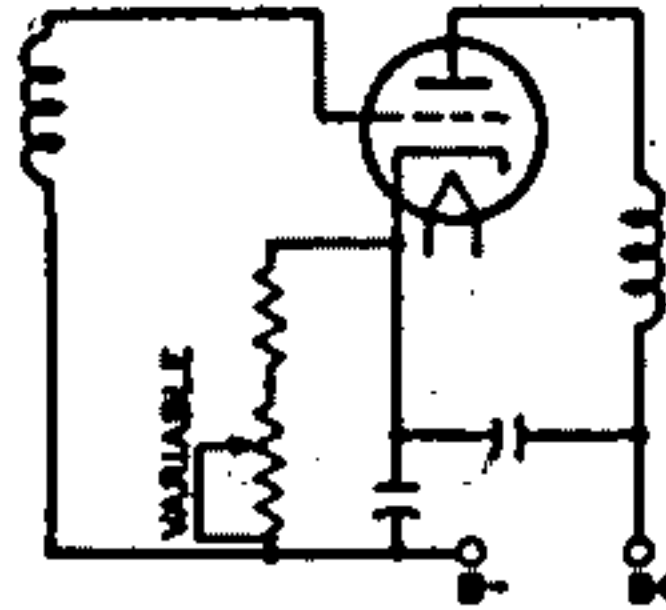


Fig. 115—Amplifier stage similar to Fig. 114 but using heater-cathode-type tube.

controlled by grid-bias variation, it is advisable to have the control voltages extend over a wide range in order to minimize cross-modulation and modulation-distortion. A remote-cutoff type of tube should, therefore, be used in the controlled stages.

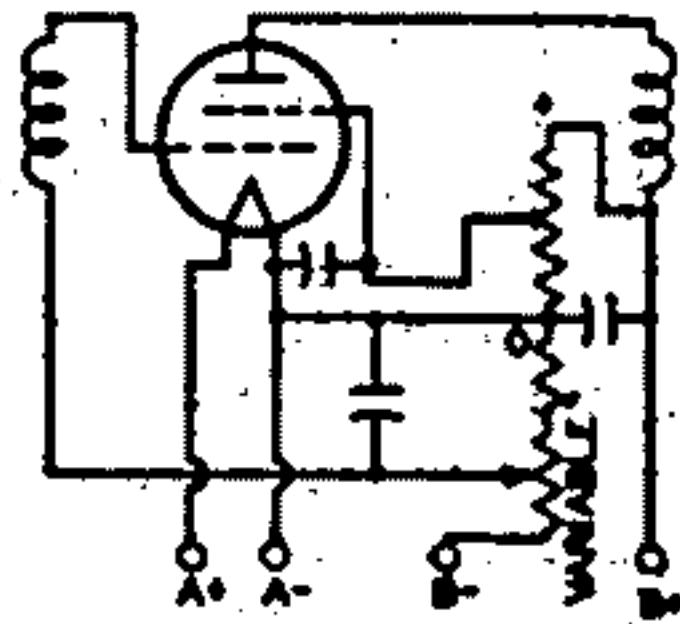


Fig. 116—Amplifier stage using a bleeder circuit and potentiometer for volume control.

In most tubes employing a unipotential cathode, a positive grid current begins to flow when the grid is slightly negative and increases rapidly as the grid is made more positive, as shown in Fig. 117. The value of grid voltage at which the grid-current curve intercepts the horizontal axis is determined by several different physical processes, including an electrothermal effect due to the differences in temperature and in material composition of the grid and the cathode, and by the positive grid current. For values of grid potentials which are larger than this intercept, the direction of the grid current is positive (*i.e.*, from the grid to the cathode). At smaller values of grid potential, the direction of the grid current

is negative (*i.e.*, from the cathode to the grid).

Positive grid current consists of electrons emitted from the cathode which are intercepted by the control grid. Negative grid current, which becomes appreciable only when the grid potential is more negative than the value of the intercept, is a result of the emission of electrons from the heated control grid to the cathode, the effect of gas molecules in the tube, and the influence of leakage currents between the grid and cathode and the grid and the plate.

The value of grid potential at the intercept of the grid-current curve on the horizontal axis (often mistakenly called **contact potential**) may be as high as  $1\frac{1}{2}$  volts. If the operating bias of the tube is less than this intercept, it is found that two effects are present. Direct current flows in the grid circuit, and the dynamic input resistance of the tube may be relatively low. It is generally desirable to supply the tube with a value of bias sufficiently high so that the operating point of the tube is not near the value of this intercept. If the value of the operating bias is near the value of the intercept, care should be taken to avoid undesirable effects in the grid circuit due to grid current or low input resistance.

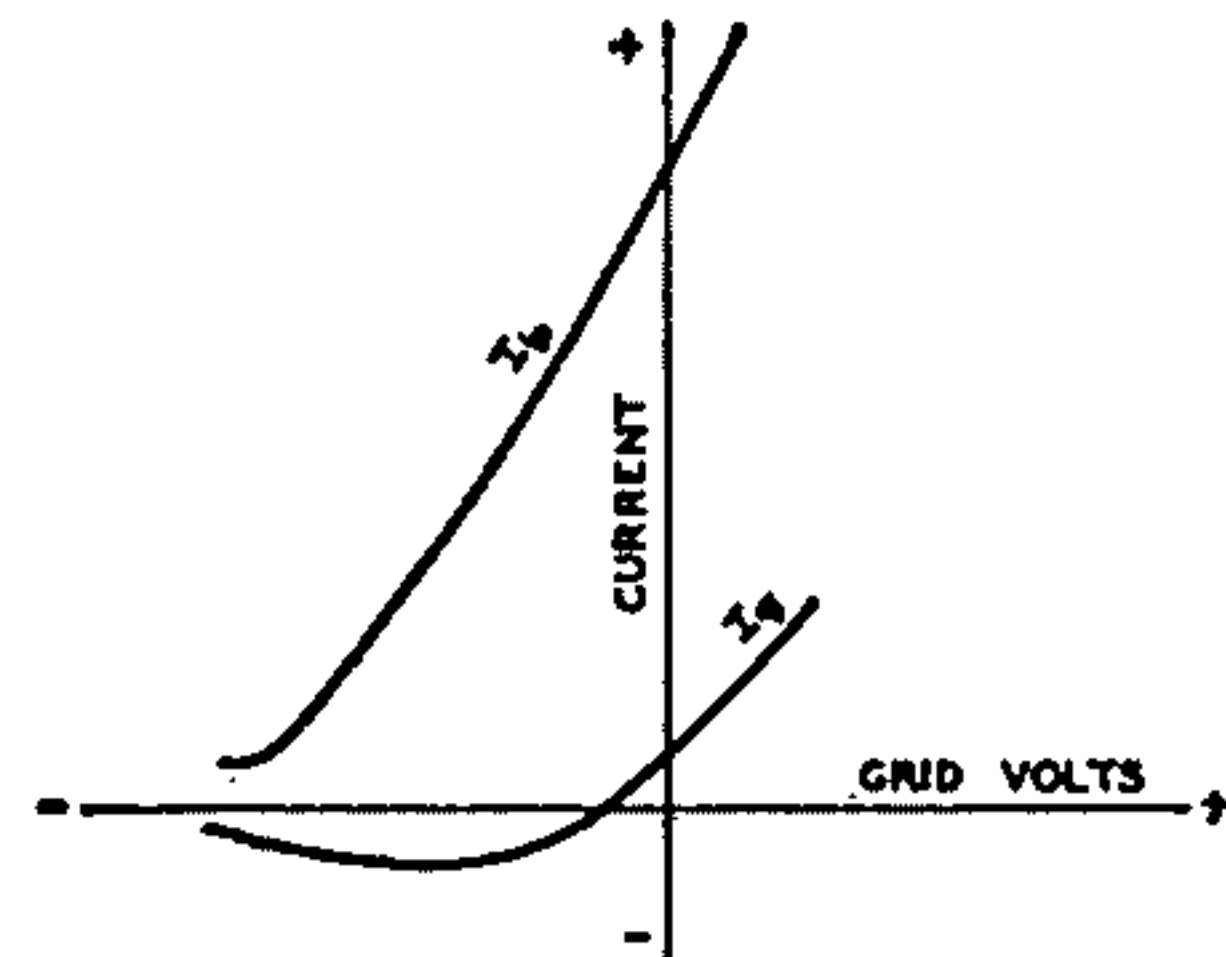


Fig. 117—Curves showing flow of positive grid current in tubes employing unipotential cathodes.

### Screen-Grid Voltage Supply

The positive voltage for the screen grid (grid No. 2) of screen-grid tubes

may be obtained from a tap on a voltage divider, from a potentiometer, or from a series resistor connected to a high-voltage source, depending on the particular tube type and its application. The screen-grid voltage for tetrodes should be obtained from a voltage divider or a potentiometer rather than through a series resistor from a high-voltage source because of the characteristic screen-grid current variations of tetrodes. Fig. 118 shows a tetrode with its screen-grid voltage obtained from a potentiometer.

When pentodes or beam power tubes are operated under conditions where a large shift of plate and screen-grid currents does not take place with the application of the signal, the screen-grid voltage may be obtained through a series resistor from a high-voltage

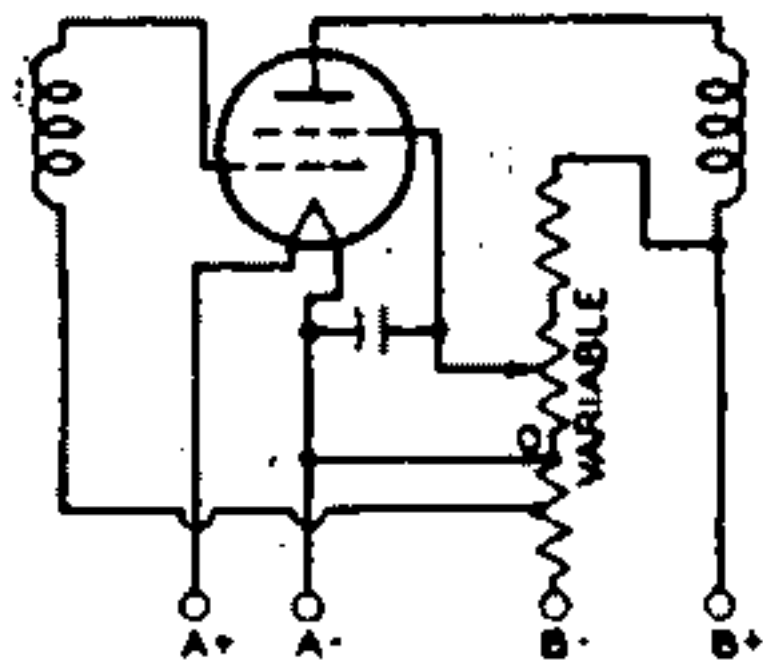


Fig. 118—Tetrode circuit in which screen-grid voltage is obtained from a potentiometer.

source. This method of supply is possible because of the high uniformity of the screen-grid current characteristic in pentodes and beam power tubes. Because the screen-grid voltage rises with increase in bias and resulting decrease in screen-grid current, the cutoff characteristic of a pentode is extended by this method of supply.

This method is sometimes used to increase the range of signals which can be handled by a pentode. When used in resistance-coupled amplifier circuits employing pentodes in combination with the cathode-biasing method, it minimizes the need for circuit adjustments. Fig. 119 shows a pentode with its screen-grid voltage supplied through a series resistor.

When power pentodes and beam power tubes are operated under conditions such that there is a large change

in plate and screen-grid currents with the application of signal, the series-resistor method of obtaining screen-grid voltage should not be used. A change in screen-grid current appears as a

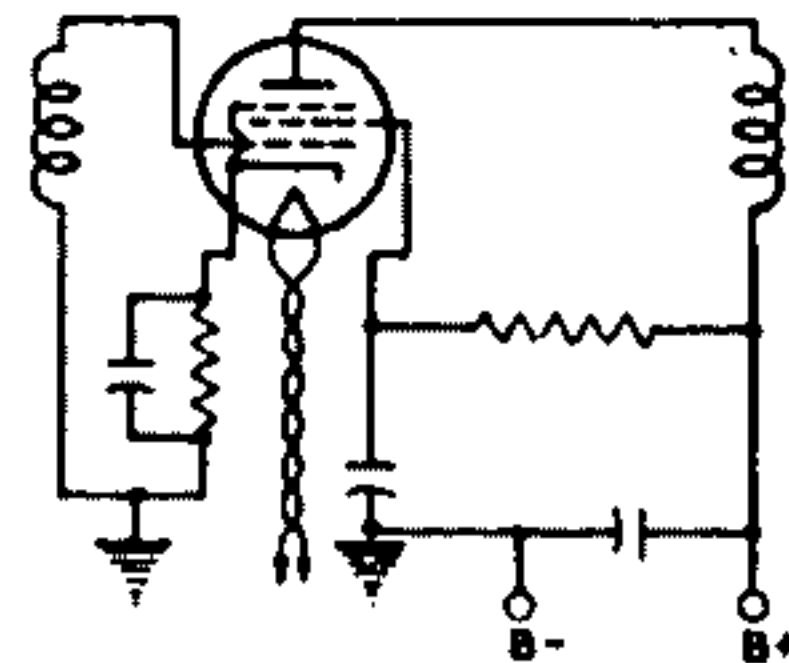


Fig. 119—Pentode circuit in which screen-grid voltage is supplied through a series resistor.

change in the voltage drop across the series resistor in the screen-grid circuit; the result is a change in the power output and an increase in distortion. The screen-grid voltage should be obtained from a point in the plate-voltage-supply filter system having the correct voltage, or from a separate source.

It is important to note that the plate voltage of tetrodes, pentodes, and beam power tubes should be applied before or simultaneously with the screen-grid voltage. Otherwise, with voltage on the screen grid only, the screen-grid current may rise high enough to cause excessive screen-grid dissipation.

Screen-grid voltage variation for the rf amplifier stages has sometimes been used for volume control in older-type receivers. Reduced screen-grid voltage decreases the transconductance of the tube and results in reduced gain per stage. The voltage variation is obtained by means of a potentiometer shunted across the screen-grid voltage supply. (See Fig. 118.) When the screen-grid voltage is varied, it must never exceed the rating of the tube. This requirement can be met by providing a fixed stop on the potentiometer.

## Shielding

In high-frequency stages having high gain, the output circuit of each stage must be shielded from the input circuit of that stage. Each high-fre-



quency stage also must be shielded from the other high-frequency stages. Unless shielding is employed, undesired feedback may occur and may produce many harmful effects on receiver performance.

To prevent this feedback, it is a desirable practice to shield separately each unit of the high-frequency stages. For instance, in a superheterodyne receiver, each if and rf coil may be mounted in a separate shield can. Baffle plates may be mounted on the ganged tuning capacitor to shield each section of the capacitor from the other section. The oscillator coil may be especially well shielded by being mounted under the chassis.

The shielding precautions required in a receiver depend on the design of the receiver and the layout of the parts. In all receivers having high-gain high-frequency stages, it is necessary to shield separately each tube in high-frequency stages. When metal tubes, and in particular the single-ended types, are used, complete shielding of each tube is provided by the metal shell which is grounded through its grounding pin as the socket terminal. The grounding connection should be short and sturdy. Many modern tubes of glass construction have internal shields, usually connected to the cathode; where present, these shields are indicated in the socket diagram.

### Dress of Circuit Leads

At high frequencies such as are encountered in FM and television receivers, lead dress, that is, the location and arrangement of the leads used for connections in the receiver, is very important. Because even a short lead provides a large impedance at high frequencies, it is necessary to keep all high-frequency leads as short as possible. This precaution is especially important for ground connections and for all connections to bypass capacitors and high-frequency filter capacitors. The ground connections of plate and screen-grid bypass capacitors of each tube should be kept short and made directly to cathode ground.

Particular care should be taken with the lead dress of the input and output circuits of high-frequency stages so that the possibility of stray coupling is minimized. Unshielded leads connected to shielded components should be dressed close to the chassis. As the frequency increases, the need for careful lead dress becomes increasingly important.

In high-gain audio amplifiers, these same precautions should be taken to minimize the possibility of self-oscillation.

### Filters

Feedback effects also are caused in radio or television receivers by coupling between stages through common voltage-supply circuits. Filters find an important use in minimizing such effects. They should be placed in voltage-supply leads to each tube in order to return the signal current through a low-impedance path direct to the tube cathode rather than by way of the voltage-supply circuit. Fig. 120 illustrates several forms of filter circuits. Capacitor C

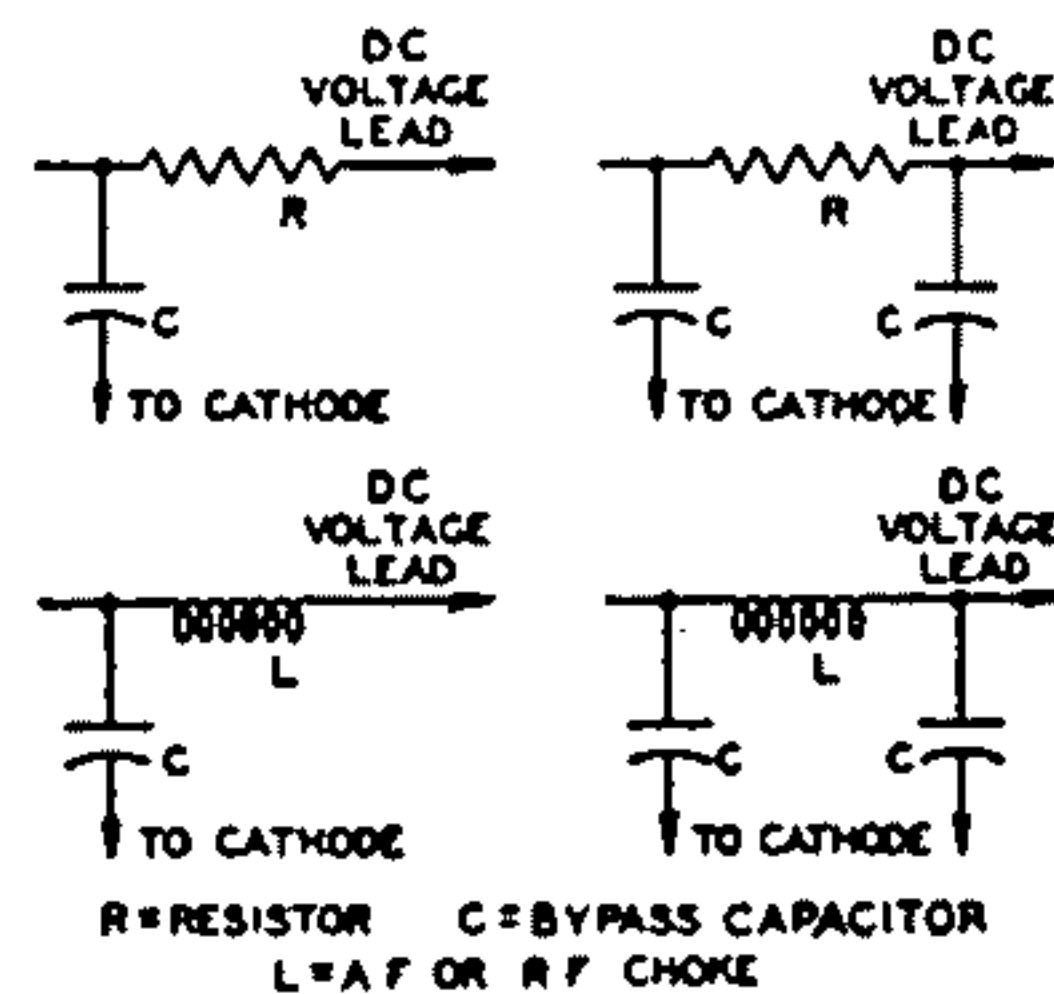


Fig. 120—Typical filter circuits.

forms the low-impedance path, while the choke or resistor assists in diverting the signal through the capacitor by offering a high impedance to the power-supply circuit.

The choice between a resistor and a choke depends chiefly upon the permissible dc voltage drop through the filter. In circuits where the current is small (a few milliamperes), resistors are practical; where the current is large or

regulation important, chokes are more suitable.

The minimum practical size of the capacitors may be estimated in most cases by the following rule: The impedance of the capacitor at the lowest frequency amplified should not be more than one-fifth of the impedance of the filter choke or resistor at that frequency. Better results will be obtained in special cases if the ratio is not more than one-tenth.

Radio-frequency circuits, particularly at high frequencies, require high-quality capacitors. Mica or ceramic capacitors are preferable. Where stage shields are employed, filters should be placed within the shield.

Another important application of filters is to smooth the output of a rectifier tube. (See **Rectification**.) A smoothing filter usually consists of capacitors and iron-core chokes. In any filter-design problem, the load impedance must be considered as an integral part of the filter because the load is an important factor in filter performance. Smoothing effect is obtained from the chokes because they are in series with the load and offer a high impedance to the ripple voltage. Smoothing effect is obtained from the capacitors because they are in parallel with the load and store energy on the voltage peaks; this energy is released on the voltage dips and serves to maintain the voltage at the load substantially constant. Smoothing filters are classified as choke-input or capacitor-input according to whether a choke or capacitor is placed next to the rectifier tube. (See Fig. 121.)

The **Circuits** section gives a number of examples of rectifier circuits with recommended filter constants.

If an input capacitor is used, consideration must be given to the instantaneous peak value of the ac input voltage. This peak value is about 1.4 times the rms value as measured by an ac voltmeter. Filter capacitors, therefore, especially the input capacitor, should have a rating high enough to withstand the instantaneous peak value if breakdown is to be avoided. When the input-choke method is used, the available dc output voltage will be somewhat lower than with the input-capacitor method for a given ac plate voltage. However, improved regulation together with lower peak current will be obtained.

Mercury-vapor and gas-filled rectifier tubes occasionally produce a form of local interference in radio receivers through direct radiation or through the power line. This interference is generally identified in the receiver as a broadly tunable 120-Hz buzz (100 Hz for 50-Hz supply line, etc.). It is usually caused by the formation of a steep wave front when plate current within the tube begins to flow on the positive half of each cycle of the ac supply voltage.

There are several ways of eliminating this type of interference. One is to shield the tube. Another is to insert an rf choke having an inductance of one millihenry or more between each plate and transformer winding and to connect high-voltage, rf bypass capacitors between the outside ends of the transformer winding and the center tap. (See Fig. 122.) The rf chokes should be placed within the shielding of the tube. The rf bypass capacitors should have a voltage rating high enough to withstand the peak voltage of each half of the secondary, which is approximately 1.4 times the rms value.

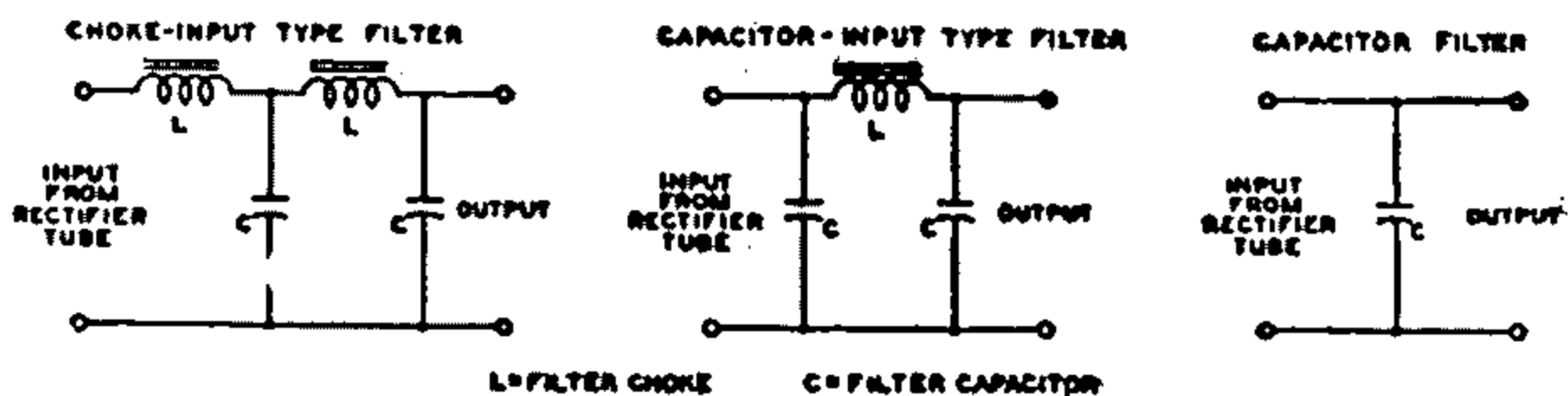


Fig. 121—Typical smoothing filters for rectifier tubes.



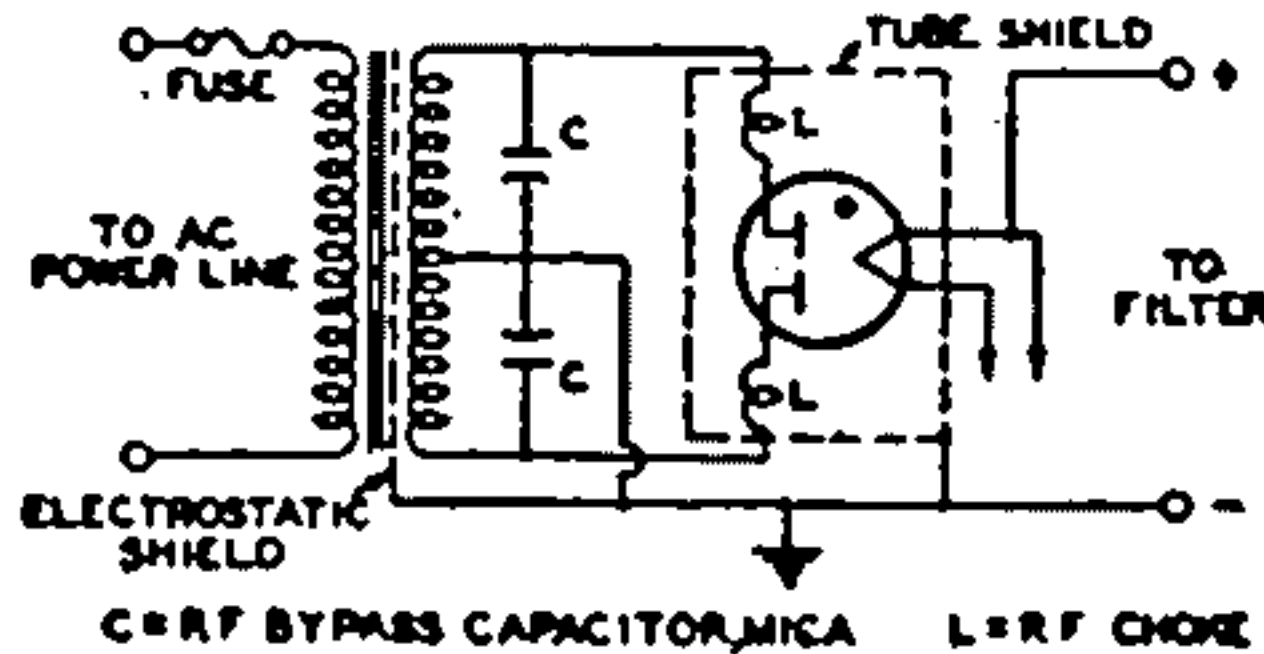


Fig. 122—Filter circuit used to eliminate interference produced by mercury-vapor or gas-filled rectifier tubes.

Transformers having electrostatic shielding between primary and secondary are not likely to transmit rf disturbances to the line. Often the interference may be eliminated simply by making the plate leads of the rectifier extremely short. In general, the particular method of interference elimination must be selected by experiment for each installation.

### Output Coupling Devices

An output-coupling device is used in the plate circuit of a power output tube to keep the comparatively high dc plate current from the winding of an electromagnetic speaker and, also, to transfer power efficiently from the output stage to a loudspeaker of either the electromagnetic or dynamic type.

Output-coupling devices are of two types, (1) choke-capacitor and (2) transformer. The choke-capacitor type includes an iron-core choke having an inductance of not less than 10 henries which is placed in series with the plate and B-supply. The choke offers a very low resistance to the dc plate current component of the signal voltage but opposes the flow of the fluctuating component. A bypass capacitor of 2 to 6 microfarads supplies a path to the speaker winding for the signal voltage. The choke-coil output coupling device, however, is now only of historical interest.

The transformer type is constructed with two separate windings, a primary and a secondary wound on an iron core. This construction permits designing each winding to meet the requirements of its position in the circuit. Typical

arrangements of each type of coupling device are shown in Fig. 123. Examples of transformers for push-pull stages are shown in several of the circuits given in the *Circuits* section.

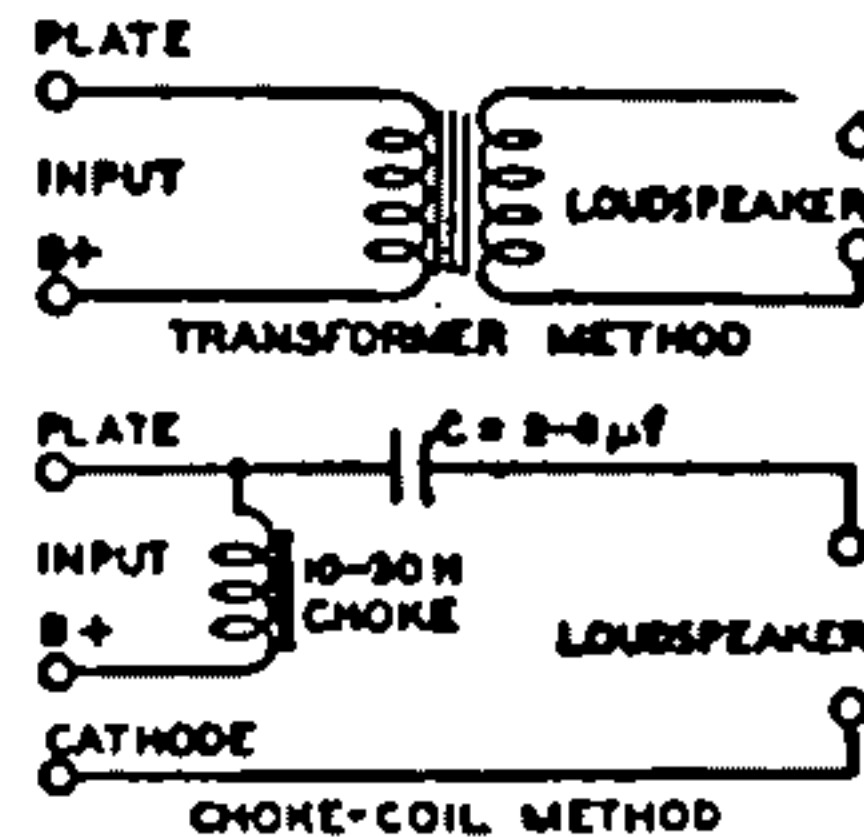


Fig. 123—Typical output-coupling devices.

### High-Fidelity Systems

The results achieved from any high-fidelity amplifier system depend to a large degree upon the skill and care with which the system is constructed. Improper placement of transformers, other components, and wiring, and attempts to achieve excessive compactness, can only result in instability, oscillation, hum, and other operating difficulties, as well as in damage to components by overheating. It is important, therefore, that construction of high-fidelity amplifier systems be undertaken only by persons who have had some experience in the layout, mechanical construction, and wiring of audio equipment.

It is impractical to give specific construction data for various amplifiers and supplementary units because the best arrangement for each unit or combination of units will depend on the requirements of the user. It is possible, however, to list some general considerations which should be observed in the construction of any high-fidelity amplifier system.

Any amplifier having two or more stages should be constructed with a straight-line layout so that maximum separation is provided between the signal input and output circuits and terminals. Power-supply connections, particularly those carrying ac, should be

isolated as far as possible from signal connections, especially from the input connection. Signal-carrying conductors, even when shielded, should not be cabled together with power-supply conductors. Internal wiring for ac-operated tube heaters, switches, pilot-light sockets, and other devices, should be twisted and placed flat against the chassis. All connections to the ground side of the circuit in each unit should be made to a common bus of heavy wire. This bus should be connected to the chassis only at the point of minimum signal voltage, *i.e.*, at the signal-input terminal of the unit.

All internal wiring that carries signal voltages should be as short as possible, and as far as possible above the chassis, to minimize losses at the higher audio frequencies due to stray shunt capacitance. All connections between units should be made with shielded cable having a capacitance of not more than 30 picofarads per foot, such as Alpha Type 1249 or 1704, Belden Type 8401 or 8410, or equivalent cable.

Because power amplifiers and power-supply units of high-fidelity systems normally dissipate large amounts of heat, they should be constructed and installed in such a manner as to assure adequate ventilation for the tubes and other components. A beam power tube or rectifier tube should be separated from any other tube or component on the same side of the chassis by at least  $1\frac{1}{2}$  tube diameters.

Power amplifiers and power-supply units which are to be installed horizontally (*i.e.*, with the tubes vertical) in cabinets or on shelves should be provided with mounting feet, perforated bottom covers, and a number of small holes around each tube socket to permit relatively cool air to enter from below and provide ventilation for the under side of the chassis and tubes.

If a power amplifier, tone-control amplifier, and one or more preamplifiers are to be constructed on the same chassis, the mechanical layout should be planned so that the circuits operating at the lowest signal levels are farthest from the output stage and

power supply. Amplifier units which normally operate at comparable signal levels but are not used simultaneously (such as preamplifiers for tape pickup heads and magnetic phonograph pickups) may be installed side by side on the same chassis without danger of interaction. Units which operate simultaneously, however (such as the channels of a stereophonic system), should not be installed side by side on the same chassis without careful consideration to placement of components and wiring, and the possible use of shielding to prevent interaction.

When an amplifier, preamplifier, mixer, or other unit requiring heater power is located more than five or six feet from its power-supply unit, the heater-current conductors in the power-supply cable must be large enough to assure that each tube receives its rated heater voltage. In cases where very large heater currents or very long power-supply cables are involved, it may be desirable to install a heater-supply transformer on or near the amplifier unit. If such a transformer is installed on or near a preamplifier for a magnetic-tape pickup head, a magnetic phonograph pickup, or a dynamic microphone, the transformer should be completely shielded and positioned to prevent its field from inducing hum in the pickup device.

### High-Voltage Considerations for Television Picture Tubes

Like other high-voltage devices, television picture tubes require that certain precautions be observed to minimize the possibility of failure caused by humidity, dust, and corona.

**Humidity Considerations.** When humidity is high, a continuous film of moisture may form on the glass bulb immediately surrounding the anode cavity cap of all-glass picture tubes or on the glass part of the envelope of metal picture tubes. This film may permit sparking to take place over the glass surface to the external conductive coating or to the metal shell. Such sparking may introduce noise into the



receiver. To prevent such a possibility, the uncoated bulb surface around the cap and the glass part of the envelope of metal picture tubes should be kept clean and dry.

**Dust Considerations.** The accumulation of dust on the uncoated area of the bulb around the anode cap of all-glass picture tubes or on the glass part of the envelope or insulating supports for metal picture tubes will decrease the insulating qualities of these parts. The dust usually consists of fibrous materials and may contain soluble salts. The fibers absorb and retain moisture; the soluble salts provide electrical leakage paths that increase in conductivity as the humidity increases. The resulting high leakage currents may overload the high-voltage power supply.

It is recommended, therefore, that the uncoated bulb surface of all-glass picture tubes and the coated glass surface and insulating supports for metal picture tubes be kept clean and free from dust or other contamination such as finger-prints. The frosted Filterglass faceplate of the metal picture tubes may be cleaned with a soapless detergent, such as Dreft, then rinsed with clean water, and immediately dried.

**Corona Considerations.** A high-voltage system may be subject to corona, especially when the humidity is high, unless suitable precautions are taken. Corona, which is an electrical discharge appearing on the surface of a conductor when the voltage gradient exceeds the breakdown value of air, causes deterioration of organic insulating materials through formation of ozone, and induces arc-over at points and sharp edges. Sharp points or other irregularities on any part of the high-voltage system may increase the possibility of corona and should be avoided.

In the metal-shell picture tubes,

the metal lip at the maximum diameter has rounded edges to prevent corona. Adequate spacing between the lip and any grounded element in the receiver, or between the small end of the metal shell and any grounded element, should be provided to preclude the possibility of corona. Such spacing should not be less than 1 inch of air. Similarly, an air space of 1 inch, or equivalent, should be provided around the body of the metal shell. As a further precaution to prevent corona, the deflecting-yoke surface on the end adjacent to the shell should present a smooth electrical surface with respect to the small end of the metal shell or the anode terminal of all-glass tubes.

### Picture-Tube Safety Considerations

**Tube Handling.** Breakage of picture tubes, which contain a high vacuum, may result in injury from flying glass. Do not strike or scratch the tube or subject it to more than moderate pressure when installing it in or removing it from electronic equipment.

**High-Voltage Precautions.** In picture-tube circuits, high voltages may appear at normally low-potential points in the circuit because of capacitor breakdown or incorrect circuit connections. Therefore, before any part of the circuit is touched the power-supply switch should be turned off, the power plug disconnected, and both terminals of any capacitors grounded.

**X-Ray Radiation Precautions.** All types of picture tubes may be operated at voltages (if ratings permit) up to 16 kilovolts without producing harmful x-ray radiation or danger of personal injury on prolonged exposure at close range. Above 16 kilovolts, special x-ray shielding precautions may be necessary.

# Interpretation of Tube Data

**T**HE tube data given in the following **Technical Data** section include ratings, typical operation values, characteristics, and characteristic curves.

The values for grid-bias voltages, other electrode voltages, and electrode supply voltages are given with reference to a specified **datum point** as follows: For types having filaments heated with dc, the negative filament terminal is taken as the datum point to which other electrode voltages are referred. For types having filaments heated with ac, the mid-point (*i.e.*, the center tap on the filament-transformer secondary, or the mid-point on a resistor shunting the filament) is taken as the datum point. For types having unipotential cathodes indirectly heated, the cathode is taken as the datum point.

**Ratings** are established on electron tube types to help equipment designers utilize the performance and service capabilities of each tube type to best advantage. Ratings are given for those characteristics which careful study and experience indicate must be kept within certain limits to insure satisfactory performance.

Three rating systems are in use by the electron-tube industry. The oldest is known as the **Absolute Maximum** system, the next as the **Design Center** system, and the latest and newest as the **Design Maximum** system. Definitions of these systems have been formulated by the Joint Electron Device Engineering Council (JEDEC) and standardized by the National Electrical Manufacturers Association (NEMA) and the Electronic Industries Association (EIA) as follows:

**Absolute Maximum** ratings are limiting values which should not be exceeded with any tube of the specified type under any condition of operation. These ratings are used only in rare instances for receiving types, but are generally used for transmitting and industrial types.

**Design Center** ratings are limiting values which should not be exceeded with a tube of the specified type having characteristics equal to the published values under normal operating conditions. These ratings, which include allowances for normal variations in both tube characteristics and operating conditions, were used for most receiving tubes prior to 1957.

**Design Maximum** ratings are limiting values which should not be exceeded with a tube of the specified type having characteristics equal to the published values under any conditions of operation. These ratings include allowances for normal variations in tube characteristics, but do not provide for variations in operating conditions. **Design Maximum** ratings were adopted for receiving tubes in 1957.

Electrode voltage and current ratings are in general self-explanatory, but a brief explanation of other ratings will aid in the understanding and interpretation of tube data.

**Heater warm-up time** is defined as the time required for the voltage across the heater to reach 80 per cent of the rated value in the circuit shown in Fig. 124. The heater is placed in series with a resistance having a value 3 times the nominal heater operating resistance



( $R = 3 E_f / I_f$ ), and a voltage having a value 4 times the rated heater voltage ( $V = 4 E_f$ ) is then applied. The warm-up time is determined when  $E = 0.8 E_f$ .

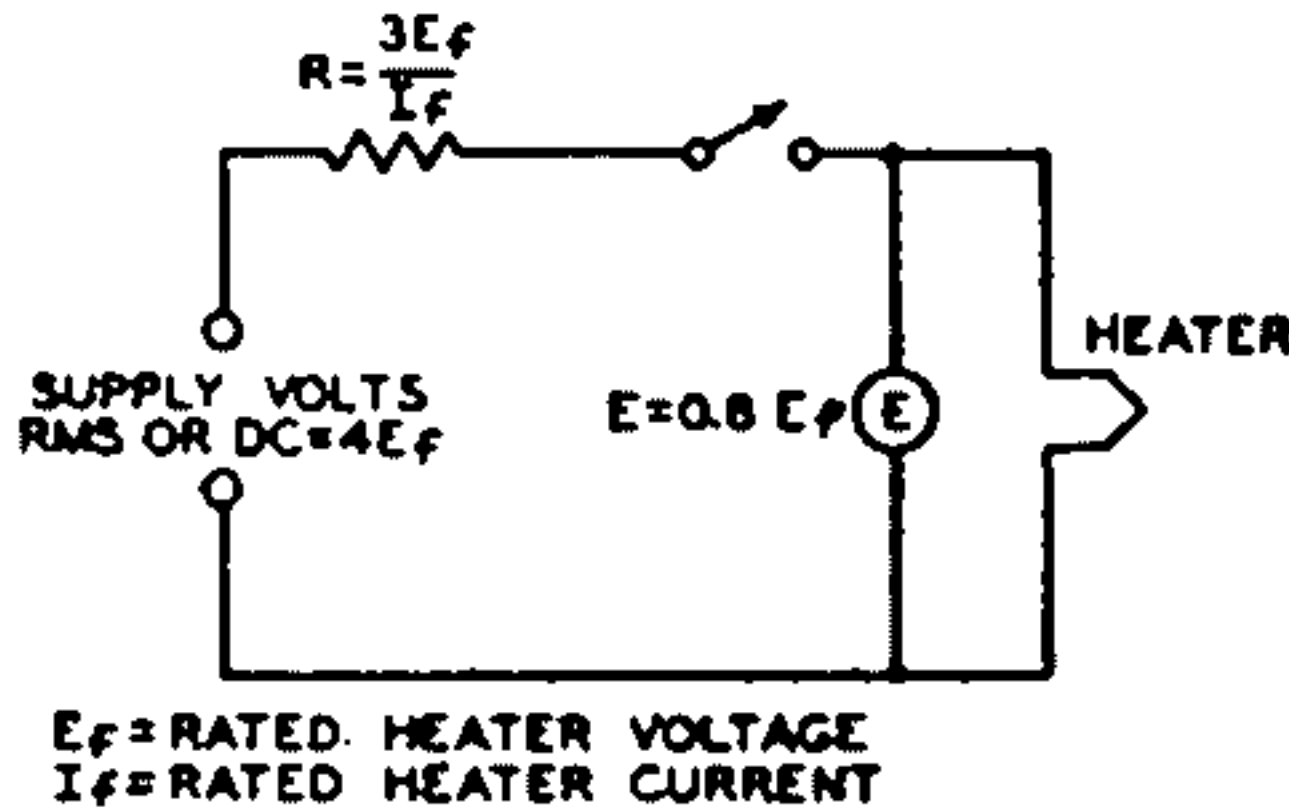


Fig. 124—Test circuit for measuring heater warm-up time.

**Plate dissipation** is the power dissipated in the form of heat by the plate as a result of electron bombardment. It is the difference between the power supplied to the plate of the tube and the power delivered by the tube to the load.

**Peak heater-cathode voltage** is the highest instantaneous value of voltage that a tube can safely stand between its heater and cathode. This rating is applied to tubes having a separate cathode terminal and used in applications where excessive voltage may be introduced between heater and cathode.

**Maximum dc output current** is the highest average plate current which can be handled continuously by a rectifier tube. Its value for any rectifier tube type is based on the permissible plate dissipation of that type. Under operating conditions involving a rapidly repeating duty cycle (steady load), the average plate current may be measured with a dc meter.

The nomograph shown in Fig. 125 can be used to determine tube voltage drop or plate current for any diode unit when values for a single plate-voltage, plate-current condition are available from the data. It can also be used to compare the relative perveance ( $G = I_p / E_p^{3/2}$ ) of several diodes. Perveance can be considered a figure of merit for diodes; high-perveance units have

lower voltage drop at a fixed current level.

Tube voltage drop or plate current for a specific diode unit can be determined as follows: First, convenient values are selected for the plate-voltage and plate-current scales of the nomograph. The published plate-current and plate-voltage values are then located on the scales and connected with a straight edge. The intersection of the connecting line with the perveance scale is then used as a pivot point to determine the value of tube voltage drop corresponding to a desired current value, or the value of plate current corresponding to a desired tube voltage drop. Because the pivot point for a specific diode

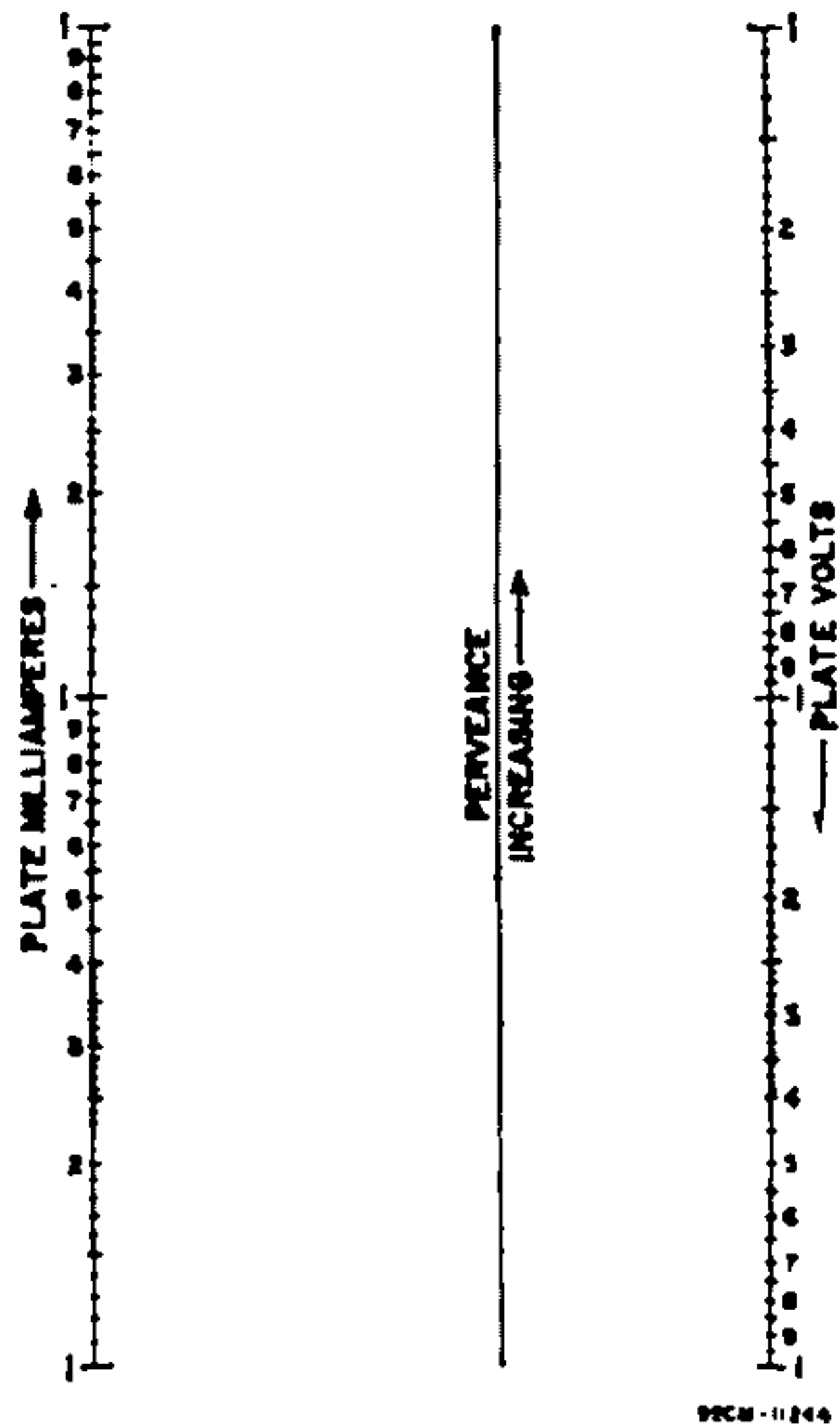


Fig. 125—Diode perveance nomograph.

unit represents its perveance, the pivot points for several units (plotted to the same scales) can be used to compare their relative perveance.

For example, type 5U4GB has a tube voltage drop (per plate) of 44 volts at a plate current of 225 milliamperes. Convenient scales for this type are from 1 to 100 volts for plate voltage and from 10 to 1000 milliamperes for plate current. The points 44 volts and 225 milliamperes are then connected with a straight line to determine the pivot point. Using this pivot point, it is easy to determine such values as a plate current of 150 milliamperes at a tube voltage drop of 33 volts, or a voltage drop of 25 for a current of 100 milliamperes.

For readings in the order of one volt and/or one milliampere, the nomograph is not accurate because of the effects of contact potential and initial electron velocity.

**Maximum peak plate current** is the highest instantaneous plate current that a tube can safely carry recurrently in the direction of normal current flow. The safe value of this peak current in hot-cathode types of rectifier tubes is a function of the electron emission available and the duration of the pulsating current flow from the rectifier tube in each half-cycle.

The value of peak plate current in a given rectifier circuit is largely determined by filter constants. If a large choke is used at the filter input, the peak plate current is not much greater than the load current; but if a large capacitor is used as the filter input, the peak current may be many times the load current. In order to determine accurately the peak plate current in any rectifier circuit, measure it with a peak-indicating meter or use an oscillograph.

**Maximum peak inverse plate voltage** is the highest instantaneous plate voltage which the tube can withstand recurrently in the direction opposite to that in which it is designed to pass current. For mercury-vapor tubes and gas-filled tubes, it is the safe top value to prevent arc-back in the tube operating within the specified temperature range.

Referring to Fig. 126, when plate A of a full-wave rectifier tube is positive, current flows from A to C, but not from B to C, because B is negative. At the

instant plate A is positive, the filament is positive (at high voltage) with respect to plate B. The voltage between the positive filament and the negative plate B is in inverse relation to that causing current flow. The peak value of this voltage is limited by the resistance and nature of the path between plate B and filament. The maximum value of this voltage at which there is no danger of breakdown of the tube is known as maximum peak inverse voltage.

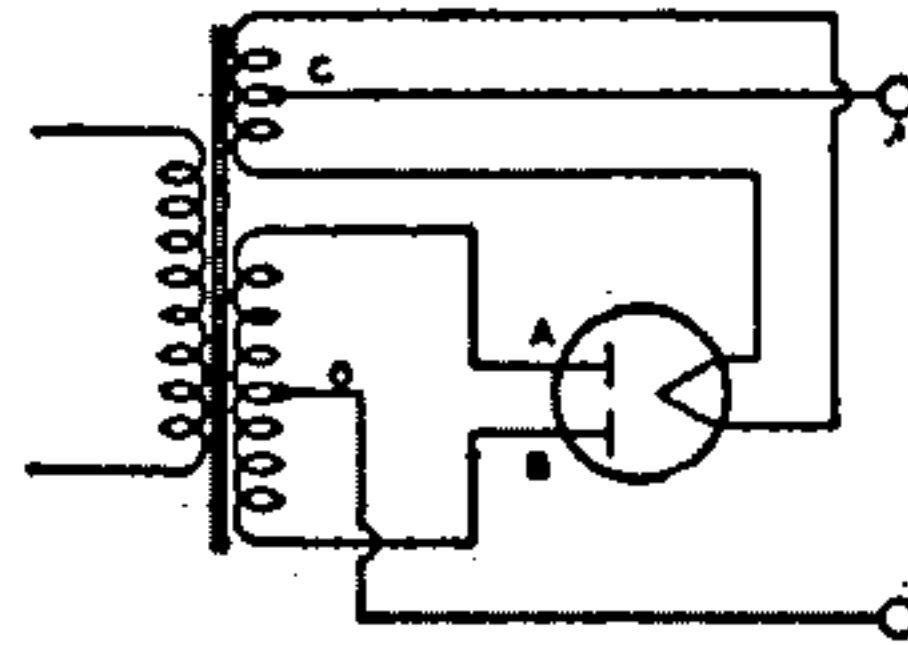


Fig. 126—Schematic diagram of full-wave rectifier tube and circuit connections.

The relations between peak inverse voltage, rms value of ac input voltage, and dc output voltage depend largely on the individual characteristics of the rectifier circuit and the power supply. The presence of line surges or any other transient, or wave-form distortion, may raise the actual peak voltage to a value higher than that calculated for sine-wave voltages. Therefore, the actual inverse voltage, and not the calculated value, should be such as not to exceed the rated maximum peak inverse voltage for the rectifier tube. A calibrated cathode-ray oscillograph or a peak-indicating electronic voltmeter is useful in determining the actual peak inverse voltage.

In single-phase, full-wave circuits with sine-wave input and with no capacitor across the output, the peak inverse voltage on a rectifier tube is approximately 1.4 times the rms value of the plate voltage applied to the tube. In single-phase, half-wave circuits with sine-wave input and with capacitor input to the filter, the peak inverse voltage may be as high as 2.8 times the rms value of the applied plate voltage.



In polyphase circuits, mathematical determination of peak inverse voltage requires the use of vectors.

The **Rating Chart** for full-wave rectifiers presents graphically the relationships between maximum ac voltage input and maximum dc output current derived from the fundamental ratings for conditions of capacitor-input and choke-input filters. This graphical presentation provides for considerable latitude in choice of operating conditions.

The **Operation Characteristics** for a full-wave rectifier with capacitor-input filter show by means of boundary line the limiting current and voltage relationships presented in the Rating Chart.

The **Operation Characteristics** for a full-wave rectifier with choke-input filter not only show by means of boundary line the limiting current and voltage relationships presented in the Rating Chart, but also give some information as to the effect on regulation of various sizes of chokes. The solid-line curves show the dc voltage outputs which would be obtained if the filter chokes had infinite inductance. The long-dash lines radiating from the zero position are boundary lines for various sizes of chokes as indicated. The intersection of one of these lines with a solid-line curve indicates the point on the curve at which the choke no longer behaves as though it had infinite inductance. To the left of the choke boundary line, the regulation curves depart from the solid-line curves as shown by the representative short-dash regulation curves.

**Typical Operation Values.** Values for typical operation are given for many types in the **Technical Data** section. These typical operating values are given to show concisely some guiding information for the use of each type. These values should not be confused with ratings, because a tube can be used under any suitable conditions within its maximum ratings, according to the application.

The power output value for any operating condition is an approximate

tube output—that is, plate input minus plate loss. Circuit losses must be subtracted from tube output in order to determine the useful output.

**Characteristics** are covered in the **Electron Tube Characteristics** section and such data should be interpreted in accordance with the definitions given in that section. **Characteristic curves** represent the characteristics of an average tube. Individual tubes, like any manufactured product, may have characteristics that range above or below the values given in the characteristic curves.

Although some curves are extended well beyond the maximum ratings of the tube, this extension has been made only for convenience in calculations. Do NOT operate a tube outside of its maximum ratings.

**Interelectrode capacitances** are direct capacitances measured between specified elements or groups of elements in electron tubes. Unless otherwise indicated in the data, all capacitances are measured with filament or heater cold, with no direct voltages present, and with no external shields. All electrodes other than those between which capacitance is being measured are grounded. In twin or multi-unit types, inactive units are also grounded.

The capacitance between the input electrode and all other electrodes, except the output electrode, connected together is commonly known as the input capacitance. The capacitance between the output electrode and all other electrodes, except the input electrode, connected together is known as the output capacitance.

**Hum and noise** characteristics of high-fidelity audio amplifier tube types such as the 7025 and the 7199 are tested in an amplifier circuit such as that shown in Fig. 127. The output of the test circuit is fed into a low-noise amplifier. The bandwidth of this amplifier depends on the characteristic being measured. If hum alone is being tested, a relatively narrow bandwidth is used to include both the line frequency and

the major harmonics generated by the tube under test. In noise or combination hum-and-noise measurements, the bandwidth is defined in the registration of the tube type.

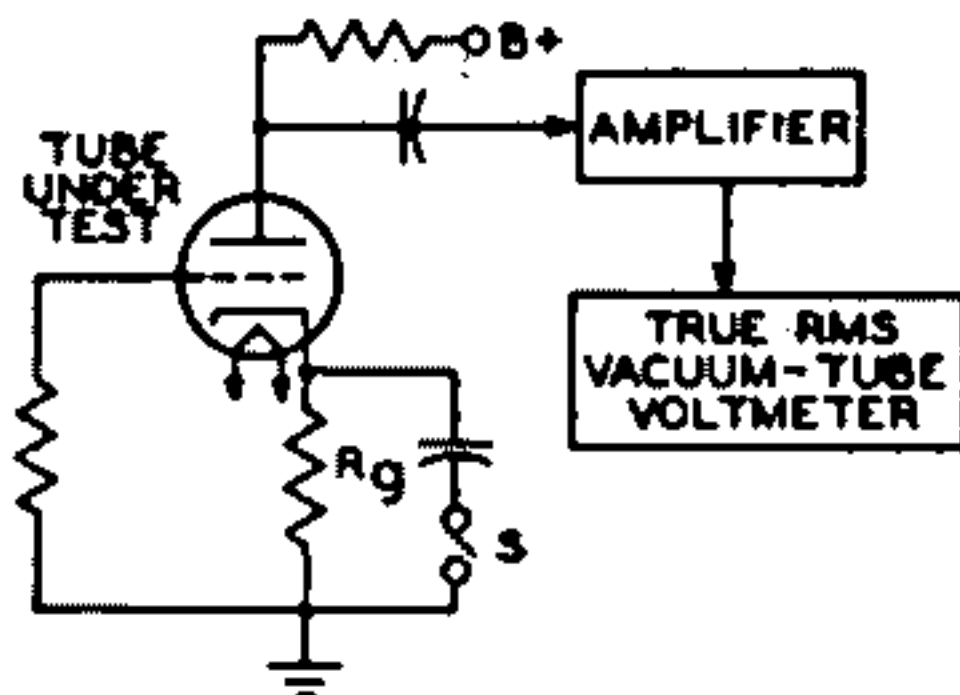


Fig. 127—Test circuit for measuring hum and noise characteristics of high-fidelity audio-amplifier tubes.

The amplifier gain is calibrated so that the vacuum-tube voltmeter measures hum and noise in microvolts referenced to the grid of the tube under test. A pentode can also be evaluated in this manner by the addition of a screen-grid supply adequately bypassed at the tube screen-grid pin connection. Power-supply ripple at the plate of the tube under test must be negligible compared to its hum and noise output. Extraordinary shielding of both the test socket and the associated operating circuit is required to minimize capacitances between heater leads and high-impedance connections.

The test-circuit components are determined by the tube type being tested and the type of hum to be controlled. Heater-cathode hum can be eliminated from the measurement by closing the switch S. The circuit can also be made more or less sensitive to heater-grid hum by increasing or decreasing the grid resistance  $R_g$ . No circuit changes affect the component of magnetic hum generated by the tube.

**Grid-No. 2 (Screen-grid) Input** is the power applied to the grid-No. 2 electrode and consists essentially of the power dissipated in the form of heat by grid No. 2 as a result of electron bombardment. With tetrodes and pentodes, the power dissipated in the screen-

grid circuit is added to the power in the plate circuit to obtain the total B-supply input power.

When the screen-grid voltage is supplied through a series voltage-dropping resistor, the maximum screen-grid voltage rating may be exceeded, provided the maximum screen-grid dissipation rating is not exceeded at any signal condition, and the maximum screen-grid voltage rating is not exceeded at the maximum-signal condition. Provided these conditions are fulfilled, the screen-grid supply voltage may be as high as, but not above, the maximum plate voltage rating.

For certain voltage amplifier types, as listed in the data section, the maximum permissible screen-grid (grid-No. 2) input varies with the screen-grid voltage, as shown in Fig. 128. (This curve cannot be assumed to apply to types other than those for which it is specified in the data section.) Full rated screen-grid input is permissible at screen-grid voltages up to 50 per cent of the maximum rated screen-grid supply voltage. From the 50-per-cent point to the full rated value of supply voltage, the screen-grid input must be decreased. The decrease in allowable screen-grid input follows a curve of the parabolic form. This rating chart is useful for applications utilizing either a fixed screen-grid voltage or a series screen-grid voltage-dropping resistor. When a fixed voltage is used, it is necessary only to determine that the screen-grid input is within the boundary of the operating area on the chart at the selected value of screen-grid voltage to be used. When a voltage-dropping resistor is used, the minimum value of resistor that will assure tube operation within the boundary of the curve can be determined from the following relation:

$$R_{gs} = \frac{E_{cs} (E_{cgs} - E_{cs})}{P_{cs}}$$

where  $R_{gs}$  is the minimum value for the voltage-dropping resistor in ohms,  $E_{cs}$  is the selected screen-grid voltage in volts,  $E_{cgs}$  is the screen-grid supply voltage in volts, and  $P_{cs}$  is the screen-grid input in watts corresponding to  $E_{cs}$ .



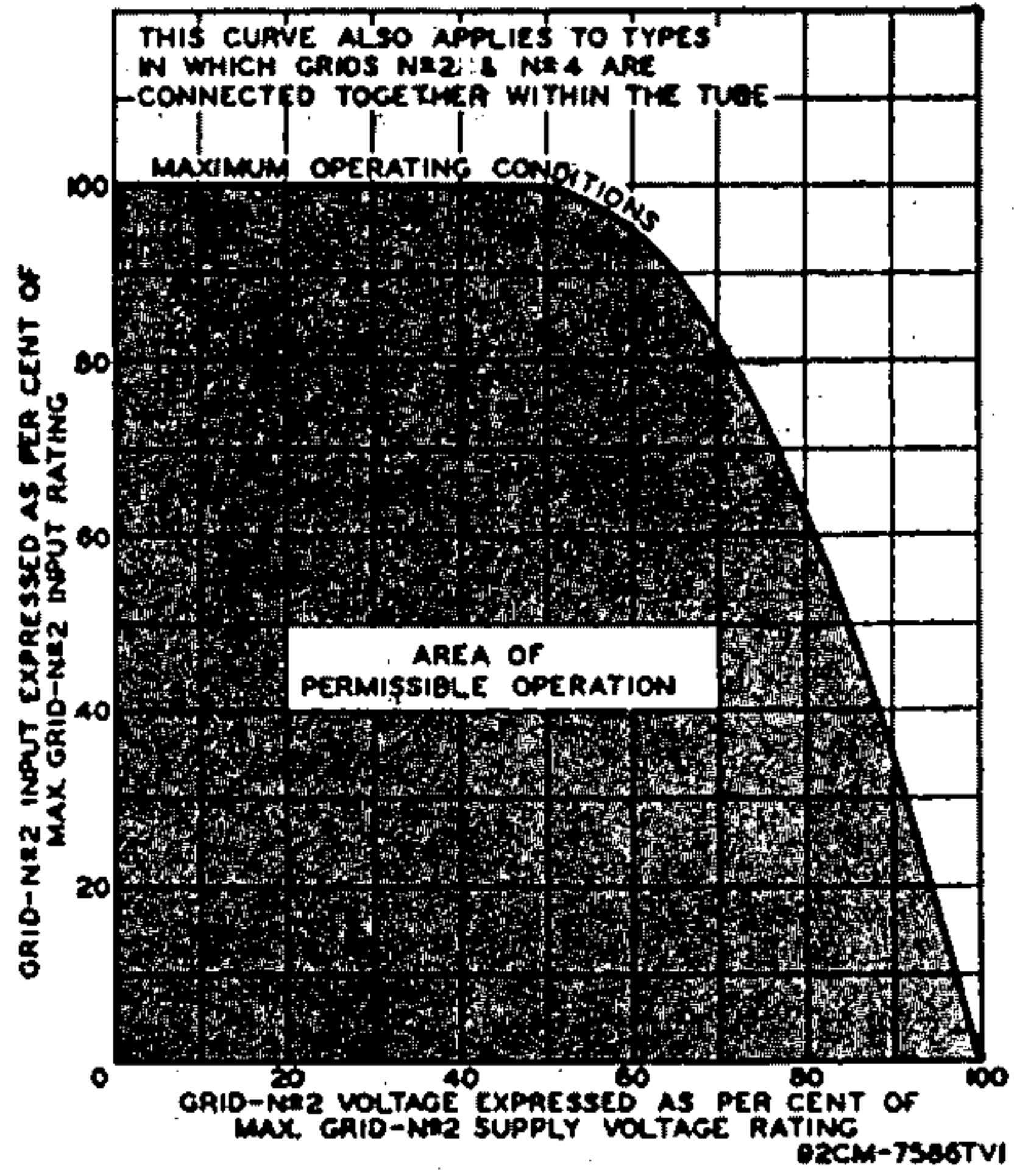


Fig. 128—Grid-No. 2 input rating curve.

# Application Guide for RCA Receiving Tubes

In the Application Guide on the following pages, RCA receiving tubes are classified in two ways: (a) by function, and (b) by structure (diode, triode, etc.). The functional classification covers 42 principal types of application, as listed below.

Tube types are grouped by structure under each classification; they are also keyed to indicate miniature, octal, nuvistor, duodecar, and novar types.

Triodes are designated as *low*, *medium*-, or *high-mu* types on the following basis: *low*, less than 10; *medium*, 10 or more, but less than 50; *high*, 50

or more. Where applicable, tubes are designated as *sharp*-, *semiremote*-, or *remote-cutoff* on the basis of the ratio, in per cent, of the negative control-grid voltage to the screen-grid voltage (or, for triodes, the plate voltage) for cutoff, as given in the characteristics or typical operation values. These terms are defined as follows: *sharp*, less than 10 per cent; *semiremote*, 10 or more, but less than 20 per cent, *remote*, 20 per cent or more.

For more complete data on these types, refer to the Technical Data For RCA Receiving Tubes.

## APPLICATIONS

- |  |   |   |
|--|---|---|
| 1. Audio-Frequency Amplifiers                    | 14. Detectors                             | 29. Noise Inverters (Noise Immune Circuits)                 |
| 2. Automatic Gain Control (AGC and AVC) Circuits | 15. DC Restorers                          | 30. Oscillators   |
| 3. Bandpass Amplifiers (Color TV)                | 16. Discriminators                        | 31. Phase Inverters   |
| 4. Blankers                                      | 17. Frequency Dividers                    | 32. Phase Splitters   |
| 5. Burst Amplifiers                              | 18. FM Detectors                          | 33. Radio-Frequency Amplifiers                              |
| 6. Cathode-Drive RF Amplifiers (Grounded-Grid)   | 19. Gated Noise, AGC, and Sync Amplifiers | 34. Reactance Circuits                                      |
| 7. Chroma Amplifiers                             | 20. Grounded-Grid RF Amplifiers           | 35. Rectifiers  |
| 8. Color Killers                                 | 21. Harmonic Generators                   | 36. Regulators  |
| 9. Color Matrixing Circuits                      | 22. Horizontal-Deflection Circuits        | 37. Sync Amplifiers   |
| 10. Complex-Wave Generators                      | 23. Intermediate-Frequency Amplifiers     | 38. Sync Clippers   |
| 11. Converters                                   | 24. Keyed AGC Amplifiers                  | 39. Sync Separators   |
| 12. Dampers                                      | 25. Limiters                              | 40. Tuning Indicators                                       |
| 13. Demodulators (Color TV)                      | 26. Mixers—RF                             | 41. Vertical-Deflection Circuits (Oscillator and Amplifier) |
|  | 27. Mixer-Oscillators—RF                  | 42. Video Amplifiers  |
|  | 28. Multivibrators                        |   |

### 1. AUDIO-FREQUENCY AMPLIFIERS

#### *Voltage Amplifiers*

Medium-Mu Triode with Twin Diode  
• 6BF6

Medium-Mu Triode—Sharp-Cutoff Pentode  
• 6LQ6 • 11LQ6 • 7199

Medium-Mu Twin Triode  
• 5J6 • 7AU7 • 12SN7GTA  
• 6J6A • 9AU7 • 19J6  
• 6SN7GTB • 17CU5

• Miniature

• Octal

† For high-fidelity equipment



**High-Mu Triode with Twin Diode**

- 3AV6      • 6BNS      • 12AV6
- 4AV6      • 6CN7      • 12SQ7
- 6AT6      • 6SQ7      • 14GT8
- 6AV6      • 12AT6      • 18FY6A

**High-Mu Triode with Triple Diode**

- 5T8      • 6T8A      • 19T8

**High-Mu Twin Triode**

- 6EU7†      • 12AZ7A      • 20EZ7
- 6SL7GT      • 12BZ7      • 70Z5†
- 12AX7A†      • 12SL7GT

**High-Mu Triode—Sharp-Cutoff Pentode**

- 6KT8

**Sharp-Cutoff Pentode**

- 3DT6A\*      • 6DT6A\*      • 5879†
- 4DT6A\*      • 6GX6\*      • 7543†
- 5GX6\*      • 6HZ6\*

**Remote-Cutoff Pentode with Diode**

- 12CR6

*Power Amplifiers***Beam Power Tube**

- 5AQ5      • 6HG5      • 12W6GT
- 5CZ5      • 6L6      † 17BF11
- 5V6GT      • 6L6GC†      • 17CU5
- † 6AD10      • 6V6      • 25C5
- 6AQ5A      • 6V6GTA      • 25F5A
- 6AS5      • 6W6GT      • 34GD5A
- † 6BF11      • 6Y6G      • 35C5
- 6CM6      • 12AB5      • 35L6GT
- 6CU5      • 12AQ5      • 50B5
- 6CZ5      † 12BF11      • 50C5
- 6DG6GT      • 12CA5      • 50L6GT
- 6DQ5      • 12CU5/12CS      • 6973†
- 6GC5      • 12V6GT      • 7400†

**Beam Power Tube—Sharp-Cutoff Pentode**

- ‡ 6AL11      ‡ 10AL11      ‡ 12AL11

**Power Pentode**

- 6BQ5      • 8BQ5      • 50EH5
- 6EH5      • 12EH5      • 60FX5
- 6F6      • 12FX5      • 7189†
- 6GK6      • 25EH5      • 7860†
- 6K6GT      • 35EH5

**Pentode—Beam Power Tube**

- ‡ 6J10      ‡ 6Z10      ‡ 13J10

**2. AUTOMATIC GAIN CONTROL CIRCUITS (AGC & AVC)****Diode—Sharp-Cutoff Pentode**

- 6KL8      • 12KL8

**Diode—Remote-Cutoff Pentode**

- 6EQ7      • 12EQ7

**Twin Diode—High-Mu Triode**

- 3AV6      • 6AV6      • 12AV6
- 4AV6      • 6SQ7      • 12SQ7
- 6AT6      • 12AT6      • 18FY6A

**Medium-Mu Triode—Sharp-Cutoff Pentode**

- 5AN8      • 6B8A      • 6GH8A
- 5GH8      • 6BH8      • 6B8A
- 6AN8A      • 6CU8      • 6BH8
- 6AZ8

**High-Mu Triode—Sharp-Cutoff Pentode**

- 6AW8A      • 6JV8      • 8JV8
- 6HF8      • 8AW8A      • 10HF8

**Sharp-Cutoff Twin Pentode**

- 3BU8      • 4BU8      • 6BU8
- 3G88      • 4H88      • 6H88
- 3H88

**3. BANDPASS AMPLIFIER (COLOR TV)****Medium-Mu Triode—Sharp-Cutoff Pentode**

- 5GH8A      • 6HL8      • 6KT8
- 6AW8A      • 6LF8      • 8AW8A
- 6GH8A

**Medium-Mu Triode—Sharp-Cutoff Pentode**

- 6AW8A      • 6KV8      • 8AW8A
- 6KT8      • 6LF8

**4. BLANKERS****Medium-Mu Triode—Sharp-Cutoff Pentode**

- 5GH8A      • 6GH8A

**Medium-Mu Twin Triode**

- 6FQ7      • 6GU7      • 12BH7A

**Medium-Mu Triode—Semiremote-Cutoff**

- 6LM8

**High-Mu Triode—Sharp-Cutoff Pentode**

- 6KT8

**5. BURST AMPLIFIERS****Beam-Deflection Tube**

- 6JH8

**Medium-Mu Triode—Sharp-Cutoff Pentode**

- 5EAS      • 6EAS      • 6GH8A
- 5GH8A

**Medium-Mu Triode—Semiremote-Cutoff Pentode**

- 6LM8

**High-Mu Triode with Twin Diodes**

- 6BN8      • 8BN8

**Sharp-Cutoff Pentode**

- 3JC6A      • 4JC6A      • 6EW6
- 4EW6      • 5EW6      • 6JC6A

• Miniature ‡ Duodecar ○ Octal \* Novar † Dual-control grids ‡ For high-fidelity equipment

**6. CATHODE-DRIVE RF AMPLIFIERS (GROUNDED-GRID)**

Medium-Mu Triode

- 6BC4

Medium-Mu. Twin Triode

- 4BC8                      • 5BK7A                      • 6BQ7A
- 4BQ7A                    • 5BQ7A                      • 6BS8
- 4BS8                      • 6BC8                        • 6BZ7
- 4BZ7                      • 6BK7A

High-Mu Triode

- ▲ 2CW4                    • 6AB4                        ▲ 6DS4
- ▲ 2DS4                    ▲ 6CW4                        ▲ 13CW4

High-Mu Twin Triode

- 6DT8                    • 12AZ7A                    • 12DT8
- 12AT7

**7. CHROMA AMPLIFIERS**

Medium-Mu Triode—Sharp-Cutoff Pentode

- 5GH8A                    • 6GH8A

Medium-Mu Triple Triode

- ▲ 6MD8

Medium-Mu Twin Triode

- 6FQ7/6CQ7              • 6GU7                        • 12BH7A

**8. COLOR KILLERS**

Quadruple Diode

- 6JUS                      • 6JUSA

Medium-Mu Triode—Sharp-Cutoff Pentode

- 5GH8A                    • 6GH8A

High-Mu Triode—Sharp-Cutoff Pentode

- 6KT8

**9. COLOR MATRIXING CIRCUITS**

Medium-Mu Twin Triode

- 6CG7                    • 6GU7                        • 8EQ7
- 6FQ7                    • 8CG7                        • 12BH7A

Medium-Mu Triode—Sharp Cutoff Pentode

- 5GH8A                    • 6GH8A

Twin Pentode

- 6LE8                    • 10LE8                      • 15LE8

Quadruple Diode

- 6JUSA

**10. COMPLEX-WAVE GENERATORS**

High-Mu Twin Double-Plate Triode

- 12FQ8

Sharp-Cutoff Twin-Plate Tetrode—Diode

- 6FA7

Sharp-Cutoff Three-Plate Tetrode—Diode

- 6EM8

Three-Plate Tetrode—Medium-Mu Triode

- 6FH8

**11. CONVERTERS**

Medium-Mu Triode—Sharp-Cutoff Pentode

- 5EA8                    • 5X8                        • 6KZ8
- 5GH8                    • 6EA8                        • 6U8A
- 5KE8                    • 6GH8A                      • 6X8
- 5U8                      • 6KE8                        • 19X8

High-Mu Twin Triode

- 6DT8                    • 12AZ7A                    • 12DT8
- 12AT7

Sharp-Cutoff Pentode

- 3AU6                    • 6AU6A                      • 18GD6A
- 4AU6                    • 12AU6

Pentagrid

- 3BE6                    • 6SA7                        • 12SA7
- 6BA7                    • 12BE6                      • 18FX6A
- 6BE6

**12. DAMPERS**

Half-Wave (Diode)

- 6AU4GTA              ▲ 6DW4B                    ▲ 17BH3
- 6AX4GTB              ○ 6W4GT                    ▲ 17BS3
- ▲ 6AY3                    ○ 12AX4GTA                ▲ 17CK3
- ▲ 6BA3                    ○ 12AX4GTB                ○ 17D4
- ▲ 6BH3                    ▲ 12AY3                    ○ 17DE4
- ▲ 6BS3                    ▲ 12BS3                    ○ 19AU4
- ▲ 6CK3                    ▲ 12CK3                    ▲ 22BH3
- ▲ 6CL3                    ▲ 12CL3                    ○ 22DE4
- 6CQ4                    ○ 12D4                      ○ 25AX4GTA
- 6DA4                    ○ 17AX4GTA                ▲ 17AY3
- 6DE4                    ▲ 17AY3                    ▲ 17BH3
- 6DM4

**13. DEMODULATORS (COLOR TV)**

Medium-Mu Twin Triode

- 12BH7A

Medium-Mu Triode—Sharp-Cutoff Pentode

- 5GH8A                    • 6GH8A

High-Mu Twin Triode

- 12AZ7A

Sharp-Cutoff Pentode

- 3BY6                    • 6GY6                        • 6HZ6
- 5HZ6

Pentagrid Amplifier

- 6BY6                    • 6JH8



**Twin Pentode**

• 6LE8      • 10LE8      • 15LE8

**Beam Deflection Tube**

• 6JH8

**14. DETECTORS****Diode—Sharp-Cutoff Pentode**

• 5AM8      • 6AM8A  
• 5A88      • 6A88

**Diode—Remote-Cutoff Pentode**

• 6CR6      • 12CR6      • 12EQ7  
• 6EQ7

**Twin Diode**

• 3AL5      • 6H6      • 12H6  
• 6AL5      • 12AL5

**Twin Diode—High-Mu Triode**

• 3AV6      • 6CN7      • 12AV6  
• 4AV6      • 6SQ7      • 12SQ7  
• 6AT6      • 8BN8      • 14GT8  
• 6AV6      • 12AT6      • 18FY6A  
• 6BN8

**Triple Diode**

• 6BJ7

**Triple Diode—High-Mu Triode**

• 5T8      • 6T8A

**Quadruple Diode**

• 6JU8      • 6JU8A

**Sharp-Cutoff Pentode**

• 3DT6A\*      • 5GX6\*      • 6GX6\*  
• 4DT6A\*      • 6DT6A\*      • 6HZ6\*

**15. DC RESTORERS****Diode—Sharp-Cutoff Pentode**

• 5AM8      • 6AM8A      • 6A88  
• 5A88

**Triple Diode**

• 6BJ7

**16. DISCRIMINATORS***FM***Twin Diode**

• 3AL5      • 6AL5      • 12AL5

**Twin Diode—High-Mu Triode**

• 6BN8      • 14GT8

**Triple Diode—High-Mu Triode**

• 5T8      • 6T8A      • 19T8

**Beam Tube**

• 3BN6      • 4BN6      • 6BN6

**Beam Power Tube—Sharp-Cutoff Pentode**

‡ 6AL11      ‡ 12AL11      ‡ 17BF11  
‡ 6BF11      ‡ 12BF11

**Pentode—Beam Power Tube**

‡ 6J10      ‡ 6Z10      ‡ 13J10

*FM Quadrature-Grid***Sharp-Cutoff Pentode**

• 3DT6A\*      • 5GY6\*      • 6GX6\*  
• 4DT6A\*      • 5HZ6\*      • 6HZ6\*  
• 5GX6\*      • 6DT6A\*

**Beam Tube**

• 3BN6      • 4BN6      • 6BN6

*Horizontal AFC***Twin Diode—High-Mu Triode**

• 6BN8      • 8BN8      • 8CN7  
• 6CN7

**17. FREQUENCY DIVIDERS****High-Mu Twin Double-Plate Triode**

• 12FQ8

**18. FM DETECTORS**

(See 14. Discriminators)

**19. GATED NOISE, AGC, AND SYNC AMPLIFIERS****High-Mu Triode—Sharp-Cutoff Pentode**

• 6KA8      • 8KA8      • 8LC8  
• 6LC8

**Sharp-Cutoff Pentode**

• 6GY6\*

**Sharp-Cutoff Twin Pentode**

• 3BU8      • 4BU8      • 6BU8  
• 3GS8      • 4HS8      • 6HS8  
• 3HS8

**Pentagrid Amplifier**

• 3BY6      • 4CS6      • 6CS6  
• 3CS6      • 6BY6

**20. GROUNDED-GRID RF AMPLIFIERS**

(See 5. Cathode-Drive RF Amplifiers)

**21. HARMONIC GENERATORS**

(See 8. Complex-Wave Generators)

**22. HORIZONTAL-DEFLECTION CIRCUITS***Oscillators***Medium-Mu Triode—Sharp-Cutoff Pentode**

• 5GH8A      • 6GH8A

• Miniature

• Octal

△ Navistor

△ Nevar

\* Dual-control grids

‡ Duodeca

**Medium-Mu Twin Triode**

- 6FQ7/6CG7    • 8CG7            • 12BH7A
- 6SN7GTB    • 9AU7           • 12SN7GTA
- 7AU7        • 12AU7A

*Amplifiers*

**Beam Power Tube**

- |            |             |             |
|------------|-------------|-------------|
| • 6AU5GT   | • 6JG6A     | • 17GJ5A    |
| • 6AV5GA   | • 6JM6A     | • 17GT5     |
| • 6BG6GA   | • 6JS6A     | • 17GW6/    |
| • 6BQ6GTB/ | • 6JT6      | 17GW6B      |
| 6CU6       | • 6JU6      | • 17JB6     |
| • 6CB5A    | • 6KM6      | • 17JG6     |
| • 6CD6GA   | • 12AV5GA   | • 17JM6A    |
| • 6DQ5     | • 12BQ6GTB/ | • 17JT6     |
| • 6DQ6B    | 12CU6       | • 22JF6     |
| • 6GJ5     | • 12DQ6B    | • 22JG6     |
| • 6GT5     | • 12GT5     | • 24JE6A    |
| • 6GW6/    | • 12GW6     | • 25AV5GA   |
| 6DQ6B      | • 12JB6     | • 25BQ6GTB/ |
| • 6JB6     | • 12JT6     | 25CU6       |
| • 6JE6A    | • 17BQ6GTB  | • 25CD6GB   |
| • 6JF6     | • 17DQ6B    | • 25DN6     |
| • 6JG6     | • 17GJ5     | • 31JS6A    |

**23. INTERMEDIATE-FREQUENCY AMPLIFIERS**

**Medium-Mu Triode—Sharp-Cutoff Tetrode**

- 5CQ8            • 6CQ8            • 6LQ8
- 5GH8A        • 6GH8A

**Medium-Mu Triode—Sharp-Cutoff Pentode**

- 5AN8            • 6AZ8            • 6CU8
- 6AN8A        • 6BH8

**High-Mu Triode—Sharp-Cutoff Pentode**

- 6AW8A        • 6KV8            • 10GN8
- 6GN8        • 8AW8A        • 10HF8
- 6HF8        • 8GN8        • 10JA8
- 6JV8        • 8JV8        • 11KV8
- 6KT8

**Sharp-Cutoff Pentode**

- |         |         |          |
|---------|---------|----------|
| • 3AU6  | • 4JC6A | • 6DK6   |
| • 3BC5  | • 4JD6* | • 6EJ7   |
| • 3CB6  | • 5EW6  | • 6EW6   |
| • 3CF6  | • 6AG5  | • 6HS6   |
| • 3DK6  | • 6AK5  | • 6JC6A  |
| • 3JC6A | • 6AU6A | • 6JD6*  |
| • 3JD6* | • 6BC5  | • 12AU6  |
| • 4AU6  | • 6CB6  | • 12AW6  |
| • 4CB6  | • 6CB6A | • 12DK6  |
| • 4DE6  | • 6CF6  | • 18GD6A |
| • 4DK6  | • 6DC6  | • 19HS6  |
| • 4EW6  | • 6DE6  |          |

**Sharp-Cutoff Pentode with Diode**

- 5AM8            • 6AM8A        • 6KL8
- 5AS8            • 6AS8        • 12KL8

**Semiremote-Cutoff Pentode**

- 3BZ6            • 4KT6            • 6HR6
- 3EH7            • 5GM6            • 6JH6
- 3KT6            • 6BZ6            • 6KT6
- 4BZ6            • 6EH7            • 12BZ6
- 4EH7            • 6GM6            • 19HR6
- 4GM6

**Remote-Cutoff Pentode**

- 3BA6            • 12BA6        • 18FW6A
- 6BA6            • 18FW6

**Remote-Cutoff Pentode with Diode**

- 6EQ7            • 12EQ7

**24. KEYED AGC AMPLIFIERS**

(See 17. Gated Noise, AGC, and Sync Amplifiers)

**25. LIMITERS**

**Beam Tube**

- 3BN6            • 4BN6            • 6BN6

**Sharp-Cutoff Pentode**

- 3AU6            • 6AU6A        • 6HZ6
- 4AU6            • 6GX6        • 12AU6
- 5GX6            • 6HS6        • 19HS6

**Sharp-Cutoff Pentode with Diode**

- 6KL8            • 12KL8

**Power Pentode—Beam Power Tube**

- ‡ 6J10            ‡ 6Z10            ‡ 13J10

**26. MIXERS—RF**

**Medium-Mu Twin Triode**

- 5J6            • 6J6A

**High-Mu Triode**

- 2CW4            • 6CW4            • 13CW4
- 6AB4

**27. MIXER-OSCILLATORS—RF**

**Medium-Mu Triode—Sharp-Cutoff Tetrode**

- 5CL8A            • 6CL8A        • 19CL8A
- 5CQ8            • 6CQ8

**Medium-Mu Triode—Sharp-Cutoff Pentode**

- |        |         |         |
|--------|---------|---------|
| • 4KE8 | • 5U8   | • 6KE8  |
| • 5AT8 | • 5X8   | • 6KZ8  |
| • 5B8  | • 6AT8A | • 6U8A  |
| • 5BR8 | • 6BR8A | • 6Z8   |
| • 5CG8 | • 6CG8A | • 9EA8  |
| • 5EA8 | • 6EA8  | • 9U8   |
| • 5FG7 | • 6FG7  | • 19EA8 |
| • 5KE8 | • 6HB7  | • 19X8  |

**High-Mu Twin Triode**

- 6DT8            • 12AT7        • 12DT8

• Miniature    ○ Octal  
 • Dual-control grids    ‡ Duodecar

\* Approaches semiremote-cutoff characteristics; used in first-if amplifier applications



**28. MULTIVIBRATORS**

Medium-Mu Triode—Sharp-Cutoff Pentode  
• 5GH8A • 6GH8A

Medium-Mu Twin Triode  
• 6CG7 • 8CG7 • 12BH7A  
• 6GU7 • 9AU7 • 12SN7-  
• 6SN7GTB • 12AU7A GTA  
• 7AU7

High-Mu Twin Triode  
• 12AX7A

**29. NOISE INVERTERS (NOISE IMMUNE CIRCUITS)**

High-Mu Triode—Sharp-Cutoff Pentode  
• 6KA8 • 8KA8 • 8LC8  
• 6LC8

Sharp-Cutoff Pentode  
• 6GY6\*

Quadruple Diode  
• 6JUBA

**30. OSCILLATORS***Radio Frequency—UHF*

Medium-Mu Triode  
• 2AF4B • 3AF4A • 6AF4A  
△ 2DV4 • 3DZ4 • △ 6DV4  
• 2DZ4 • 6AF4 • 6DZ4

*Radio Frequency—VHF*

Medium-Mu Twin Triode  
• 5J6 • 6J6A

High-Mu Triode  
• 6AB4

Power Triode  
• 6CA (Class C)

*3.58-MHz (Color TV)*

Medium-Mu Triode—Sharp-Cutoff Pentode  
• 5GH8A • 6GH8A • 6KT8

*Low Frequency, Sweep Type*

Medium-Mu Triode—Sharp-Cutoff Pentode  
• 5AN8 • 6B8A • 8AU8  
• 6AN8A • 6BH8 • 8BA8B  
• 6AUBA • 6CH8 • 8BH8  
• 6AZ8

High Mu Triode with Twin Diode  
• 6BN8 • 8BN8 • 8CN7  
• 6CN7

High-Mu Twin Triode  
• 12AX7A

**31. PHASE INVERTERS**

Medium-Mu Triode—High-Mu Triode  
• 12DW7

Medium-Mu Twin Triode  
• 6CG7 • 8CG7 • 12BH7A  
• 6GU7 • 9AU7 • 12SN7-  
• 6SN7GTB • 12AU7A GTA  
• 7AU7

High-Mu Triode—Sharp-Cutoff Pentode  
• 6AW8A • 8AW8A • 10GN8  
• 6EB8 • 8EB8 • 10HF8  
• 6GN8 • 8GN8 • 10JA8  
• 6HF8

High-Mu Twin Triode  
• 6SL7GT • 12SL7GT • 7025  
• 12AX7A

**32. PHASE SPLITTERS**

Medium-Mu Triode—Sharp-Cutoff Tetrode  
• 5CQ8 • 6CQ8

Medium-Mu Triode—Sharp-Cutoff Pentode  
• 5AN8 • 6B8A • 8B8A  
• 6AN8 • 6CH8 • 7199  
• 6AZ8 • 6CU8

High-Mu Triode—Sharp-Cutoff Pentode  
• 6AW8A • 8AW8A

**33. RADIO-FREQUENCY AMPLIFIERS**

Medium-Mu Triode  
• 2BN4A • 6BC4 • 6BN4A  
• 3BN4A

Medium-Mu Triode—Sharp-Cutoff Tetrode  
• 5CQ8 • 6CQ8

Medium-Mu Twin Triode  
• 4BC8 • 5BQ7A • 6BS8  
• 4BQ7A • 5J6 • 6BZ7  
• 4BS8 • 6BC8 • 6J6A  
• 4BZ7 • 6BK7B • 12AV7  
• 5BK7A • 6BQ7A

High-Mu Triode  
△ 2CW4 • 3ER5 • △ 6DS4  
△ 2DS4 • 3FH5 • • 6ER5  
△ 2EG4 • 3GK5 • • 6FH5  
• 2ER5 • 3HM5/3HA5 • 6FQ5A  
• 2FH5 • 4GK5 • • 6GK5  
• 2FQ5A • 6AB4 • • 6HM5/6HA  
• 2GK5 • △ 6CW4 • • 13CW4

High-Mu Twin Triode  
• 6DT8 • 12AZ7A • 12DT8

• Miniature

• Octal

△ Navistor

\* Dual-control grids

**Power Triode**

- 6C4 (Class C)

**Sharp-Cutoff Tetrode**

- 2CY5      • 4CY5      • 6FV6
- 3CY5      • 6CY5

**Sharp-Cutoff Pentode**

- 3AU6      • 6AK5      • 6DE6
- 3BC5      • 6AU6A    • 6SH7
- 3CB6      • 6BC5      • 6SJ7
- 3CF6      • 6BH6      • 12AU6
- 4AU6      • 6CB6      • 12AW6
- 4CB6      • 6CB6A    • 12SH7
- 4DE6      • 6CP6      • 12SJ7
- 6AG5      • 6DC6      • 18GD6A

**Sharp-Cutoff Pentode with Diode**

- 6KL8      • 12KL8

**Remote-Cutoff Pentode**

- 3BA6      • 6BJ6      • 12BA6
- 6BA6      • 6SK7GT   • 18RW6A

**Remote-Cutoff Pentode with Diode**

- 6EQ7      • 12EQ7

**34. REACTANCE CIRCUITS**

**Medium-Mu Triode—Sharp-Cutoff Pentode**

- 5AN8      • 6BA8A    • 6CU8
- 6AN8A    • 6CH8      • 8BA8A
- 6AZ8

**High-Mu Triode with Twin Diodes**

- 6CN7      • 8CN7

**High-Mu Triode—Sharp-Cutoff Pentode**

- 6AW8A    • 8AW8A

**35. RECTIFIERS**

*Power-Supply Types—Vacuum*

**Half-Wave (Diode)**

- 35W4      • 36AM3B    • 50DC4
- 35Z5GT

**Full-Wave (Twin Diode)**

- 3DG4      • 5V3A      • 6CA4
- 5AR4/GF34 • 5VG4      • 6X4
- 5AS4A    • 5V4GA    • 6X5GT
- 5BC3      • 5XG4      • 12CA4
- 5DJ4      • 5Y3GT    • 12X4
- 5U4G      • 5Z4        • 25CA4
- 5U4GB

*High-Voltage Types (For rf-rectifier or pulsed low-current applications)—Vacuum*

**Half-Wave (Diode)**

- 1BC2      • 1V2        • 3A2
- 1G3GT/    • 1X2B      • 3A3A
- 1B3GT    • 2AY2      • 3CA3
- 1K3/1J3   • 2BJ2

**36. REGULATORS (HIGH VOLTAGE, LOW CURRENT)**

**Sharp-Cutoff Beam Triode**

- 6BK4A    • 6BK4B

**37. SYNC AMPLIFIERS**

**Medium-Mu Triode—Sharp-Cutoff Pentode**

- 6AU8A    • 6CX8      • 8CX8
- 6AZ8      • 8AU8

**Medium-Mu Twin Triode**

- 6CG7      • 8CG7      • 12AU7A
- 7AU7

**High-Mu Triode with Twin Diode**

- 6CN7      • 8CN7

**High-Mu Triode—Sharp-Cutoff Pentode**

- 6AW8A    • 6JV8      • 8JV8
- 6HF8      • 8AW8A    • 10HF8

**High-Mu Twin Triode**

- 12BZ7

**38. SYNC CLIPPERS**

**Medium-Mu Triode—Sharp-Cutoff Tetrode**

- 5CQ8      • 6CQ8

**Medium-Mu Triode—Sharp-Cutoff Pentode**

- 5AN8      • 6AZ8      • 6CX8
- 6AN8A    • 6CH8      • 8CX8
- 6AU8A    • 6CU8      • 8AU8

**High-Mu Triode—Sharp-Cutoff Pentode**

- 6AW8A    • 6HF8      • 8JV8
- 6EB8      • 6JV8      • 10GN8
- 6GN8      • 8AW8A    • 10HF8
- 6GW8/    • 8EB8      • 10JA8
- ECL86    • 8GN8

**High-Mu Twin Triode**

- 12BZ7

**Sharp-Cutoff Twin Pentode**

- 3BU8      • 4BU8      • 6BU8
- 3G88      • 4H88      • 6H88
- 3H88

**Pentagrid Amplifier**

- 3BY6      • 4CS6      • 6CS6
- 3CS6      • 6BY6

**39. SYNC SEPARATORS**

**Medium-Mu Triode—Sharp-Cutoff Tetrode**

- 5CQ8      • 6CQ8

• Miniature      • Octal      • Novar



**Medium-Mu Triode—Sharp-Cutoff Pentode**

- 5AN8                      • 6CUB                      • 6LQ8
- 5GH8A                    • 6CX8                      • 8AUB
- 6AN8A                    • 6GH8                      • 8CX8
- 6AUBA                    • 6HLS                      • 8CX8
- 6AZ8                      • 6GH8A

**Medium-Mu Twin Triode**

- 6CG7                      • 8CG7                      • 12AU7A
- 7AU7

**High-Mu Triode with Twin Diode**

- 6CN7                      • 8CN7

**High-Mu Triode—Sharp-Cutoff Pentode**

- 6AW8A                    • 6KV8                      • 8KAS
- 6EB8                      • 6LC8                      • 8LC8
- 6GN8                      • 8AW8A                    • 10GN8
- 6HF8                      • 8EB8                      • 10HF8
- 6JV8                      • 8GN8                      • 10JAS
- 6KAS                      • 8JV8                      • 11KV8
- 6KT8

**High-Mu Twin Triode**

- 12BZ7

**Sharp-Cutoff Twin Pentode**

- 3BUB                      • 4BUB                      • 6BUB
- 3G88                      • 4G88/4BUB              • 6H88
- 3H88                      • 4H88

**Pentagrid Amplifier**

- 3BY6                      • 4CS6                      • 6CS6
- 3CS6                      • 6BY6

**40. TUNING INDICATORS****Indicator with Triode Unit**

- 6E5

**Twin Indicator Units**

- ◉ 6AF6G

**41. VERTICAL-DEFLECTION CIRCUITS****Oscillators and Amplifiers (Combined)****Medium-Mu Triode—Low-Mu Triode**

- 6DE7                      • 10DE7                    • 13DE7
- 6EW7

**Medium-Mu Dual Triode**

- 6CM7                      • 8CM7                      • 8CS7
- 6CS7

**Medium-Mu Twin Triode**

- 6PQ7/6CG7

**High-Mu Triode—Low-Mu Triode**

- 6CY7                      ◈ 6GF7                      ◈ 10GF7
- 6DR7                      ◈ 6GF7A                    ◉ 11CY7
- 6EA7                      ◉ 6GL7                      • 13DR7
- ◉ 6EM7                      • 10DR7                    ◉ 13EM7
- ◈ 6FD7                      ◉ 10EM7                    ◈ 13FD7
- ◈ 13GF7

**High-Mu Triode—Beam Power Tube**

- ◈ 6KY8                      ◈ 15KY8                    ◈ 15KY8A
- ◈ 6KY8A

**Dual Triode**

- ◉ 6EM7                      ◈ 6GF7A

**Amplifiers****Low-Mu Triode**

- 12B4A

**Medium-Mu Triode**

- 6S4A

**Beam Power Tube**

- 5AQ5                      • 6AQ5A                    • 6EM5
- 5CZ5                      • 6CM6                      • 8EM5
- ◉ 5V6GT                    • 6CZ5                      • 12AQ6

**Power Pentode**

- 6HR5                      ◉ 6K6GT

**42. VIDEO AMPLIFIERS****Medium-Mu Triode—Sharp-Cutoff Pentode**

- 5AN8                      • 6BH8                      • 8AUB
- 5GH8A                    • 6CUB                      • 8B8A
- 6AN8A                    • 6CX8                      • 8BH8
- 6AUBA                    • 6GH8A                    • 8CX8
- 6AZ8                      • 6HLS                      • 11LQ8
- 6B8A                      • 6LQ8

**High-Mu Triode—Sharp-Cutoff Pentode**

- 6AW8A                    • 6KV8                      • 10GN8
- 6EB8                      • 6LF8                      • 10HF8
- 6GN8                      • 8AW8A                    • 10JAS
- 6HF8                      • 8EB8                      • 11KV8
- 6JV8                      • 8GN8                      • 12KV8
- 6KT8                      • 8JV8

**Sharp-Cutoff Pentode**

- 3JC6A                      • 6JC6A                      • 12BY7A
- 4JC6A                      • 11HM7                    1 12HG7

**Sharp-Cutoff Pentode with Diode**

- 5AM8                      • 6AM8A                    • 6AS8
- 5AS8

**Beam Power Tube**

- 6BK5                      • 25BK5

**Power Pentode**

- ◉ 6AG7                      • 6GK6                      • 16GK6
- 6CL6

• Miniature

◉ Octal

◈ Novar

‡ Duodecar

# Technical Data for RCA Tube Types

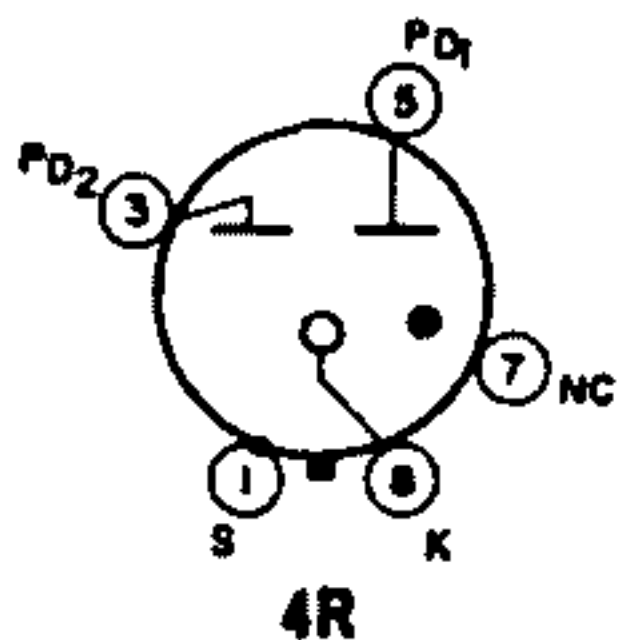
**T**HIS section contains technical descriptions of RCA tubes used in standard broadcast, FM, and television receivers, in audio amplifiers, and in many other diverse applications. It includes detailed data on current types, including characteristics curves in many cases. Essential information on types intended primarily for replacement use and on discontinued types in which there may still be some interest is given in chart form at the end of the section. Characteristics charts for RCA television picture tubes for replacement use and for RCA voltage-regulator and voltage-reference tubes are given in the following section.

In choosing tube types for the design of new electronic equipment, the designer should refer to the **Application Guide for RCA Receiving Tubes** in the pages immediately preceding this section.

Tube types are listed in this section according to the numerical-alphabetical-numerical sequence of their type designations. For Key: Basing Diagrams, see inside back cover.

Refer to chart at end of data section.

**OZ4**



## FULL-WAVE GAS RECTIFIER

**OZ4A**

Metal type used as a power rectifier in equipment with vibrator-type power supplies. Outlines section, 2A; requires octal socket. This tube, like other power-handling tubes, should be adequately ventilated.

### Full-Wave Rectifier

#### MAXIMUM AND MINIMUM RATINGS (Design-Center Values)

Peak Inverse Plate Voltage (Per Plate) .....	880 max	volts
Peak Starting-Supply Voltage (Per Plate) .....	300 <sup>a</sup> min	volts
Peak Plate Current (Per Plate) .....	380 max	mA
DC Output Current .....	{ 110 max	mA
	{ 80 <sup>a</sup> min	mA

#### TYPICAL OPERATION WITH VIBRATOR-TYPE POWER SUPPLY AND CAPACITOR INPUT TO FILTER

Peak Plate Supply Voltage (Per Plate)† .....	440	volts
Filter-Input Capacitor .....	8	μF
Total Effective Plate Supply Impedance (Per Plate) .....	600	ohms
DC Output at Input to Filter .....	310	volts
DC Output Current .....	100	mA

#### CHARACTERISTICS

Tube Voltage Drop for current of 110 mA (Per Plate) .....	24	volts
---	----	-------

#### MINIMUM CIRCUIT VALUE

Total Effective Plate-Supply Impedance (Per Plate) .....	300	ohms
--	-----	------

<sup>a</sup> Absolute value. Under no circumstances should the tube be operated below the value shown.

† Open-circuit voltage (flat portion of transformer voltage wave).

Refer to chart at end of section.

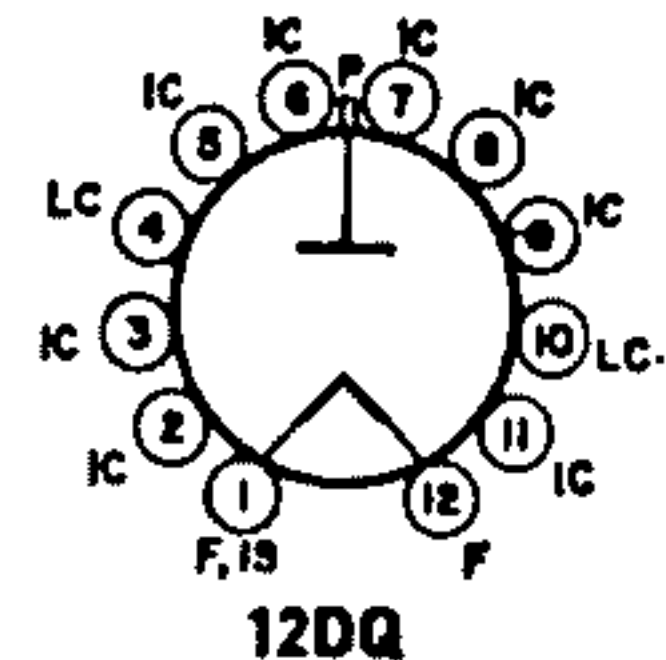
**OZ4G**



- 1A3** Refer to chart at end of section.
- 1A4P** Refer to chart at end of section.
- 1A5GT** Refer to chart at end of section.
- 1A6** Refer to chart at end of section.
- 1A7GT** Refer to chart at end of section.
- 1AC5** Refer to chart at end of section.

**1AD2 HALF-WAVE VACUUM RECTIFIER**

Duodecar type used as a rectifier in high-voltage pulse circuits of color and black-and-white television receivers. Outlines section, 9A; requires duodecar 12-contact socket. Socket terminals 4 and 10 may be used as tie points for components at or near filament potential. For high-voltage and X-ray safety considerations, refer to type 1G3GT/1B3GT.



Filament Voltage (ac/dc)	1.25	volts
Filament Current	0.2	ampere
Direct Interelectrode Capacitance (Approx.):		
Plate to Filament	1.6	pF

**Pulsed Rectifier**

For operation in a 525-line, 30-frame system

**MAXIMUM RATINGS (Design-Maximum Values)**

Peak Inverse Plate Voltage#	26000*	volts
Peak Plate Current	50	mA
Average Plate Current	0.5	mA

**CHARACTERISTICS, Instantaneous Value**

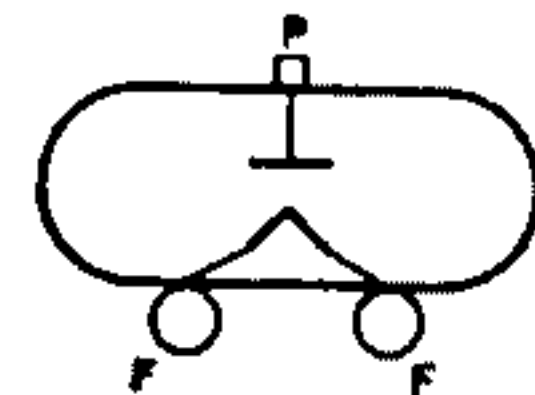
Tube Voltage Drop for plate current of 7 mA	225	volts
---	-----	-------

# Pulse duration must not exceed 15% of a horizontal scanning cycle (10 microseconds).  
\* The dc component must not exceed 22000 volts.

- 1AD5** Refer to chart at end of section.
- 1AX2** Refer to chart at end of section.

**1AY2 HALF-WAVE VACUUM RECTIFIER**

Miniature type used to supply high voltage to the anode of the picture tube in television receivers. Outlines section, 33A; requires 2-contact socket. For high-voltage and X-ray safety considerations, refer to type 1G3GT/1B3GT.



**9DP**

Filament Voltage (ac/dc)	1.25	volts
Filament Current	0.2	ampere
Direct Interelectrode Capacitances:		
Plate to Filament	1.4	pF

**Pulsed Rectifier**

For operation in a 525-line, 30-frame system

**MAXIMUM RATINGS (Design-Maximum Values)**

Peak Inverse Plate Voltage#	26000*	volts
Peak Plate Current	50	mA
Average Plate Current	0.5	mA

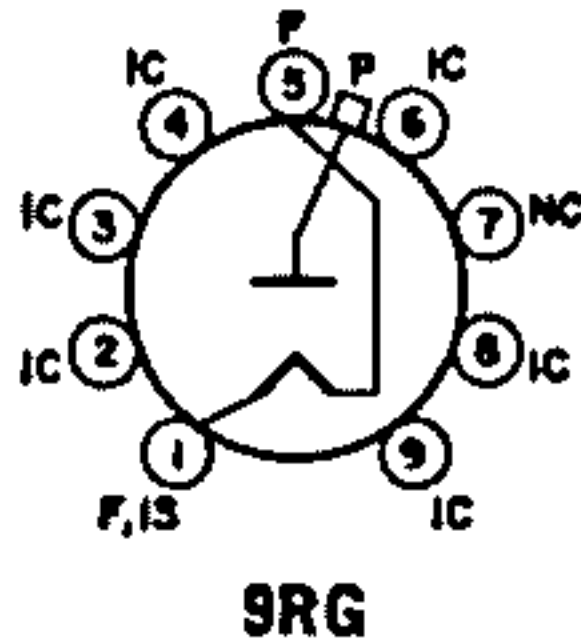
**CHARACTERISTICS, Instantaneous Value**

Tube Voltage Drop for plate current of 7 mA	75	volts
---	----	-------

# Pulse duration must not exceed 15% of a horizontal scanning cycle (10 microseconds).  
\* The dc component must not exceed 22000 volts.

Refer to chart at end of section.  
 Refer to chart at end of section.  
 Refer to chart at end of section.  
 Refer to chart at end of section.

**1B3GT**  
**1B4P**  
**1B5/25S**  
**1B7GT**



**HALF-WAVE  
 VACUUM RECTIFIER**

**1BC2**

Duodecar type used as a rectifier in high-voltage pulse circuits of black-and-white television receivers. Outlines section, 7E; requires miniature 9-contact socket. Socket terminal 7 may be used as a tie point for components at or near filament potential. For high-voltage and X-ray safety considerations, refer to type 1G3GT/1B3GT.

Filament Voltage (ac/dc) .....	1.25	volts
Filament Current .....	0.2	ampere
Direct Interelectrode Capacitance:		
Plate to Filament .....	1.0	pF

**Pulsed Rectifier**

For operation in a 525-line, 30-frame system

<b>MAXIMUM RATINGS (Design-Maximum Values)</b>		
Peak Inverse Plate Voltage# .....	18000*	volts
Peak Plate Current .....	45	mA
Average Plate Current .....	0.5	mA

<b>CHARACTERISTICS, Instantaneous Value</b>		
Tube Voltage Drop for plate current of 7 mA .....	80	volts

# Pulse duration must not exceed 15% of a horizontal scanning cycle (10 microseconds).

\* The dc component must not exceed 15000 volts.

Refer to chart at end of section.  
 Refer to chart at end of section.  
 Refer to chart at end of section.  
 Refer to chart at end of section.  
 Refer to chart at end of section.  
 Refer to chart at end of section.  
 Refer to chart at end of section.  
 Refer to chart at end of section.  
 Refer to chart at end of section.  
 Refer to chart at end of section.  
 Refer to chart at end of section.  
 Refer to chart at end of section.  
 Refer to chart at end of section.

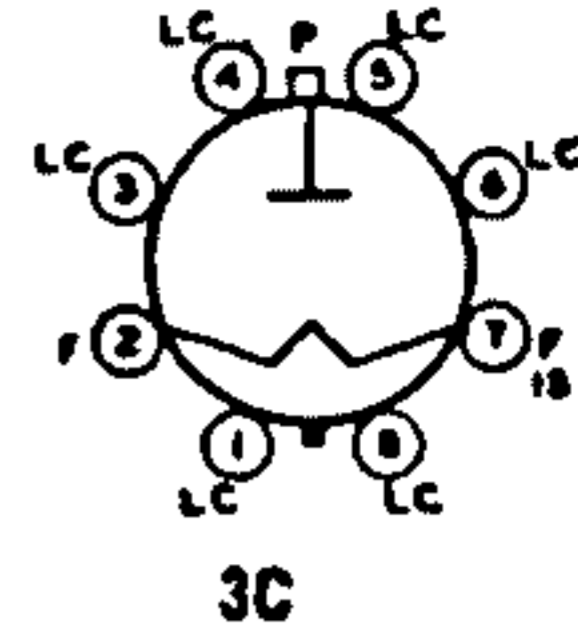
**1C5GT**  
**1C6**  
**1C7G**  
**1D5GP**  
**1D5GT**  
**1D7G**  
**1D8GT**  
**1DN5**  
**1E5GP**  
**1E7GT**  
**1E8**  
**1F4**  
**1F5G**  
**1F6**  
**1F7G**



# 1G3GT/ 1B3GT

## HALF-WAVE VACUUM RECTIFIER

Glass octal type used as a rectifier in high-voltage pulse circuits of color and black-and-white television receivers or as a rectifier in a high-voltage rf-operated power supply.



Filament Voltage (ac/dc) .....	1.25*	volts
Filament Current .....	0.2	ampere
Direct Interelectrode Capacitance (Approx.):		
Plate to Filament and Internal Shield .....	1.3	pF

\* Under no circumstances should the filament voltage be less than 1.05 volts or greater than 1.45 volts.

### Pulsed Rectifier

For operation in a 525-line, 30-frame system

#### MAXIMUM RATINGS (Design-Maximum Values)

Peak Inverse Plate Voltage# .....	26000*	volts
Peak Plate Current .....	50	mA
Average Plate Current .....	0.5	mA

#### CHARACTERISTICS, Instantaneous Value

Tube Voltage Drop for plate current of 7 mA .....	100	volts
---	-----	-------

### Radio-Frequency Rectifier

#### MAXIMUM RATINGS (Design-Maximum Values)

Peak Inverse Plate Voltage .....	33000	volts
Peak Plate Current .....	85	mA
Average Plate Current .....	1.1	mA
Frequency Range of Supply Voltage .....	1.5 to 100	kHz

# Pulse duration must not exceed 15% of a horizontal scanning cycle (10 microseconds).

\* The dc component must not exceed 22000 volts.

## Installation and Application

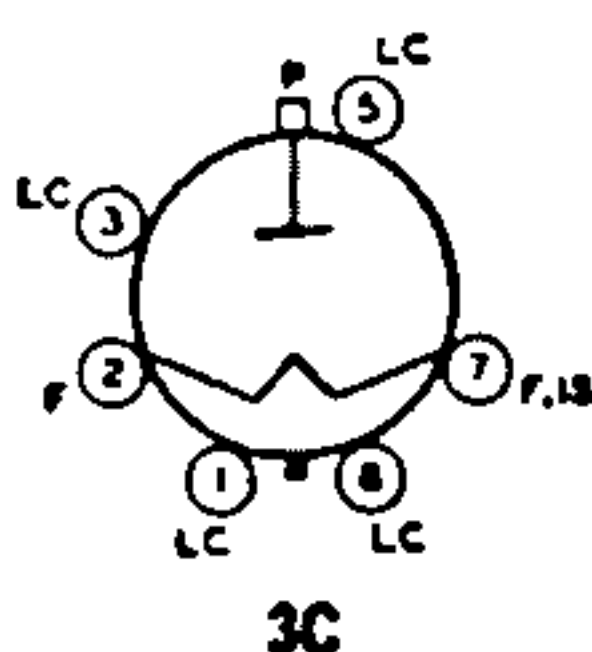
Type 1G3GT/1B3GT requires an octal socket. Plate connection is cap at top of bulb. Socket terminals 1, 3, 4, 5, 6, and 8 may be connected to socket terminal 7 or to a corona shield which is connected to socket terminal 7. Socket terminals 4 and 6 may be used as tie points for components at or near filament potential. This type may be supplied with pins 1, 4, and/or 6 omitted. Outlines section, 14B.

The high voltages at which the 1G3GT/1B3GT is operated are very dangerous. Great care should be taken during the adjustment of circuits. The tube and its associated apparatus, especially all parts which may be at high potential with respect to ground, should be housed in a protective enclosure. The protective housing should be designed with interlocks so that personnel cannot possibly come in contact with any high-potential point in the electrical system. The interlock devices should function to break the primary circuit of the high-voltage supply when any gate or door on the protective housing is opened, and should prevent the closing of this primary circuit until the door is locked again.

It should be noted that high voltages may appear at normally low-potential points in the circuit as a result of capacitor breakdown or incorrect circuit connections. Therefore, before any part of the circuit is touched, the power-supply switch should be turned off and both terminals of any capacitor should be grounded.

Operation of the 1G3GT/1B3GT with a plate voltage above approximately 16000 volts (absolute value) results in the production of X-rays which can constitute a health hazard on prolonged exposure at close range unless the tube is adequately shielded. Relatively simple shielding should prove adequate, but the need for this precaution should be considered.

Refer to chart at end of section.	<b>1G4GT</b>
Refer to chart at end of section.	<b>1G5G</b>
Refer to chart at end of section.	<b>1G6GT</b>
Refer to chart at end of section.	<b>1H4G</b>
Refer to chart at end of section.	<b>1H5GT</b>
Refer to chart at end of section.	<b>1H6G</b>
Refer to chart at end of section.	<b>1J3</b>
Refer to chart at end of section.	<b>1J5G</b>
Refer to chart at end of section.	<b>1J6G</b> <b>1J6GT</b>
Refer to chart at end of section.	<b>1K3</b>



**HALF-WAVE  
VACUUM RECTIFIER**

**1K3/1J3**

Glass octal type used as a rectifier in high-voltage pulse circuits of black-and-white television receivers. Plate connection is cap at top of bulb. Socket terminals 1, 3, 4, 5, 6, and 8 may be connected to socket terminal 7 or to a corona shield which is connected to socket terminal 7. Socket terminals 4 and 6 may be used as tie points for components at or near filament potential.

Outlines section, 14B; requires octal socket. For high-voltage and X-ray safety considerations, refer to type 1G3GT/1B3GT.

Filament Voltage (ac/dc)	1.25	volts
Filament Current	0.2	ampere
Direct Interelectrode Capacitance (Approx.):		
Plate to Filament and Internal Shield	1.6	pF

\* Under no circumstances should the filament voltage be less than 1.05 volts or greater than 1.45 volts.

**Pulsed Rectifier**

Per operation in a 525-line, 30-frame system

**MAXIMUM RATINGS (Design-Maximum Values)**

Peak Inverse Plate Voltage*	26000*	volts
Peak Plate Current	50	mA
Average Plate Current	0.5	mA

**CHARACTERISTICS, Instantaneous Value**

Tube Voltage Drop for plate current of 7 mA	225	volts
---	-----	-------

\* Pulse duration must not exceed 15% of a horizontal scanning cycle (10 microseconds).

\* The dc component must not exceed 22000 volts.

Refer to chart at end of section.	<b>1L6</b>
Refer to chart at end of section.	<b>1LA4</b>
Refer to chart at end of section.	<b>1LA6</b>
Refer to chart at end of section.	<b>1LB4</b>
Refer to chart at end of section.	<b>1LC5</b>
Refer to chart at end of section.	<b>1LC6</b>
Refer to chart at end of section.	<b>1LD5</b>



<b>1LE3</b>	Refer to chart at end of section.
<b>1LG5</b>	Refer to chart at end of section.
<b>1LH4</b>	Refer to chart at end of section.
<b>1LN5</b>	Refer to chart at end of section.
<b>1N2A</b>	Refer to chart at end of section.
<b>1N5GT</b>	Refer to chart at end of section.
<b>1N6G</b>	Refer to chart at end of section.
<b>1P5GT</b>	Refer to chart at end of section.
<b>1Q5GT</b>	Refer to chart at end of section.
<b>1R5</b>	Refer to chart at end of section.

## 1S2A/DY87

### HALF-WAVE VACUUM RECTIFIER

Miniature type used in high-voltage, low-current applications in television scanning circuits. Outlines section, 7F; requires miniature 9-contact socket. Socket terminals 3 and 7 may be used as tie points for components at or near heater potential. For high-voltage considerations, refer to type 1G3GT/1B3GT.

Heater Voltage (ac/dc) .....	1.4	volts
Heater Current .....	0.55	ampere
Direct Interelectrode Capacitance:		
Plate to cathode and heater .....	1.8	pF

#### Pulsed Rectifier

For operation in a 525-line, 30-frame system

#### MAXIMUM RATINGS (Design-Center Values)

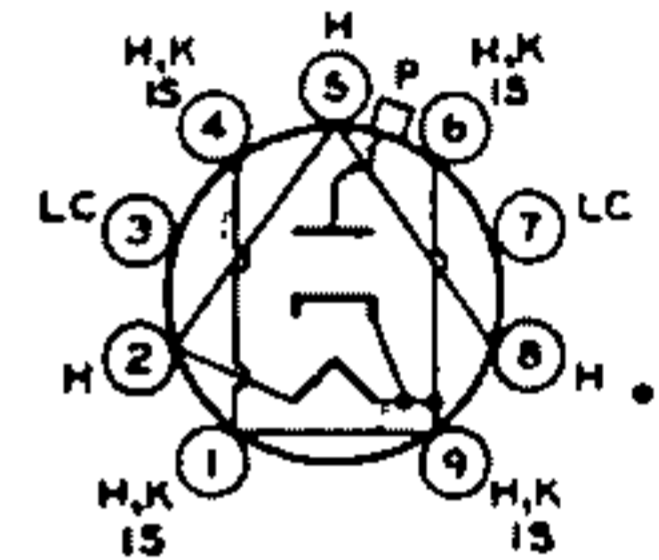
Peak Inverse Plate Voltage# .....	22000	volts
Peak Plate Current .....	40	mA
Average Plate Current .....	0.8	mA

#### CHARACTERISTICS, Instantaneous Value

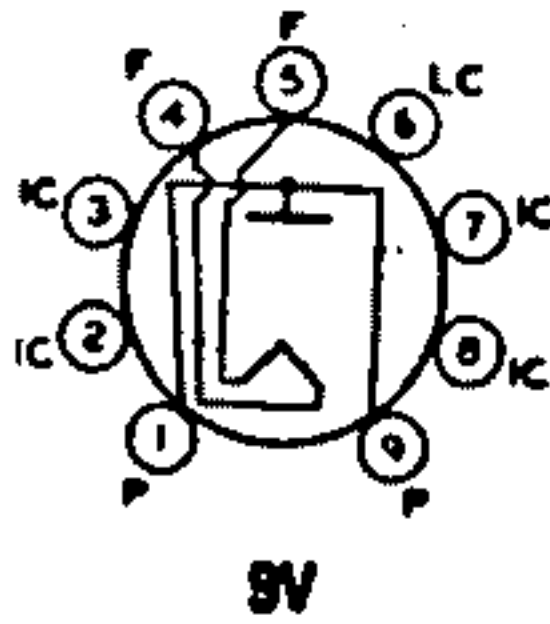
Tube Voltage Drop for plate current of 7 mA .....	100	volts
---	-----	-------

# Pulse duration must not exceed 10% of a horizontal scanning cycle (10 microseconds).

<b>1S4</b>	Refer to chart at end of section.
<b>1S5</b>	Refer to chart at end of section.
<b>1T4</b>	Refer to chart at end of section.
<b>1T5GT</b>	Refer to chart at end of section.
<b>1T6</b>	Refer to chart at end of section.
<b>1U4</b>	Refer to chart at end of section.
<b>1U5</b>	Refer to chart at end of section.
<b>1V</b>	Refer to chart at end of section.



9SDT



**HALF-WAVE  
VACUUM RECTIFIER**

**1V2**

Miniature type used as a doubler in high-voltage pulse rectifier circuits of black-and-white television receivers and as a focus rectifier in color television receivers. The very low power required by the filament permits the use of a rectifier transformer having small size and light weight. Outlines section, 6B; requires miniature 9-contact socket. For high-voltage and X-ray safety considerations, refer to type 1G3GT/1B3GT.

Filament Voltage (ac) .....	0.625*	volt
Filament Current .....	0.8	ampere
Direct Interelectrode Capacitance:		
Plate to Filament (Approx.) .....	0.8	pF

\* Under no circumstances should the filament voltage be less than 0.525 volt or greater than 0.725 volt.

**Pulsed Rectifier**

For operation in a 525-line, 30-frame system

**MAXIMUM RATINGS (Design-Maximum Values)**

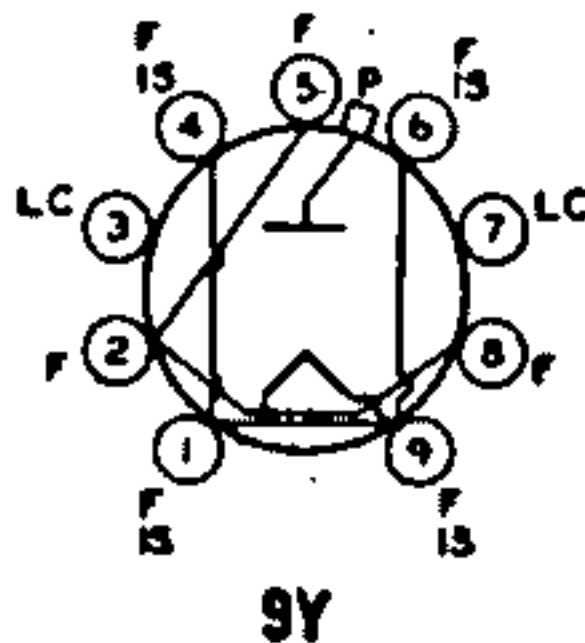
Peak Inverse Plate Voltage# .....	8250*	volts
Peak Plate Current .....	11	mA
Average Plate Current .....	0.6	mA

# Pulse duration must not exceed 15% of a horizontal scanning cycle (10 microseconds).

\* The dc component must not exceed 7000 volts.

**1X2A**

Refer to chart at end of data section.



**HALF-WAVE  
VACUUM RECTIFIER**

**1X2B**

Miniature type used as a rectifier in high-voltage pulse circuits of black-and-white television receivers and as a focus rectifier in color television receivers. Outlines section, 7A; requires miniature 9-contact socket. Socket terminals 3 and 7 may be used as tie points for components at or near filament potential. For high-voltage and X-ray safety considerations, refer to type 1G3GT/1B3GT.

Filament Voltage (ac) .....	1.25*	volts
Filament Current .....	0.2	ampere
Direct Interelectrode Capacitance:		
Plate to Filament and Internal Shield (Approx.) .....	1.0	pF

\* Under no circumstances should the filament voltage be less than 1.05 volts or greater than 1.45 volts.

**Pulsed Rectifier**

For operation in a 525-line, 30-frame system

**MAXIMUM RATINGS (Design-Maximum Values)**

Peak Inverse Plate Voltage# .....	22000*	volts
Peak Plate Current .....	45	mA
Average Plate Current .....	0.5	mA

**CHARACTERISTICS, Instantaneous Value**

Tube Voltage Drop for plate current of 7 mA .....	100	volts
---	-----	-------

# Pulse duration must not exceed 15% of a horizontal scanning cycle (10 microseconds).

\* The dc component must not exceed 18000 volts.

Refer to chart at end of section.

**2A3**

Refer to chart at end of section.

**2A5**

Refer to chart at end of section.

**2A6**

Refer to chart at end of section.

**2A7**



**2AF4A**

Refer to chart at end of section.

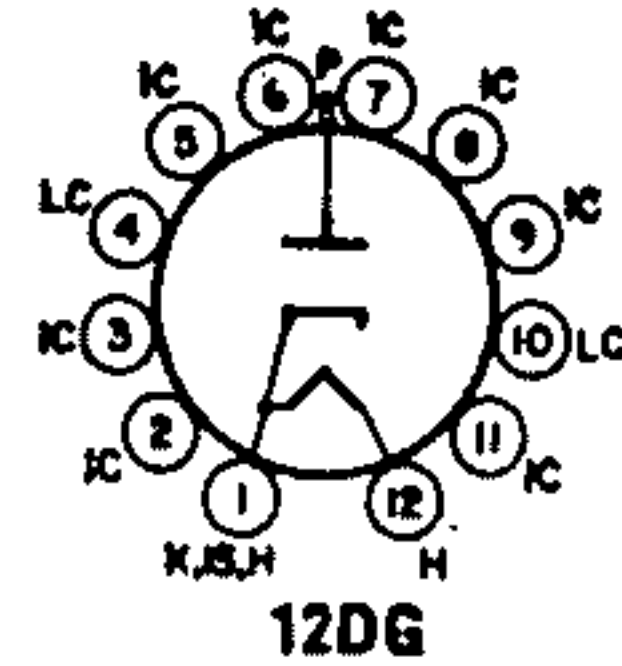
**2AF4B**

Refer to type 6AF4A.

**2AH2**

**HALF-WAVE  
VACUUM RECTIFIER**

Duodecar type used as a rectifier in high-voltage pulse circuits of black-and-white television receivers. Outlines section, 9A; requires duodecar 12-contact socket. Socket terminals 4 and 10 may be used as tie points for components at or near heater potential. For high-voltage and X-ray safety considerations, refer to type 1G3GT/1B3GT. Heater: volts (ac/dc), 2.5; amperes, 0.3.



**Pulsed Rectifier**

For operation in a 525-line, 30-frame system

**MAXIMUM RATINGS (Design-Maximum Values)**

Peak Inverse Plate Voltage#	80000*	volts
Peak Plate Current	80	mA
Average Plate Current	1.5	mA

**CHARACTERISTICS, Instantaneous Value**

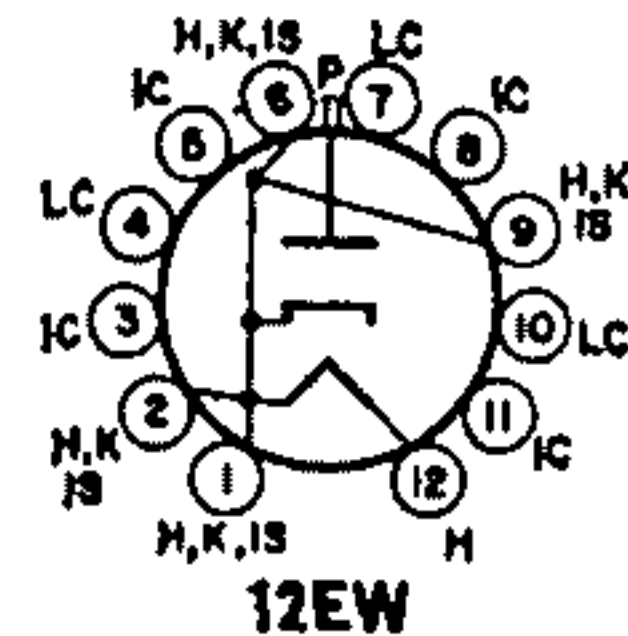
Tube Voltage Drop for plate current of 7 mA	100	volts
---	-----	-------

# Pulse duration must not exceed 15% of a horizontal scanning cycle (10 microseconds).  
\* The dc component must not exceed 24000 volts.

**2AS2**

**HALF-WAVE  
VACUUM RECTIFIER**

Duodecar type used as a rectifier in high-voltage pulse circuits of black-and-white television receivers. Outlines section, 9B; requires duodecar 12-contact socket. Socket terminals 4, 7, and 10 may be used as tie points for components at or near heater potential. For high-voltage and X-ray safety considerations, refer to type 1G3GT/1B3GT. Heater: volts (ac/dc), 2.5; amperes, 0.33.



**Pulsed Rectifier**

For operation in a 525-line, 30-frame system

**MAXIMUM RATINGS (Design-Maximum Values)**

Peak Inverse Plate Voltage#	30000*	volts
Peak Plate Current	80	mA
Average Plate Current	1.5	mA

**CHARACTERISTICS, Instantaneous Value**

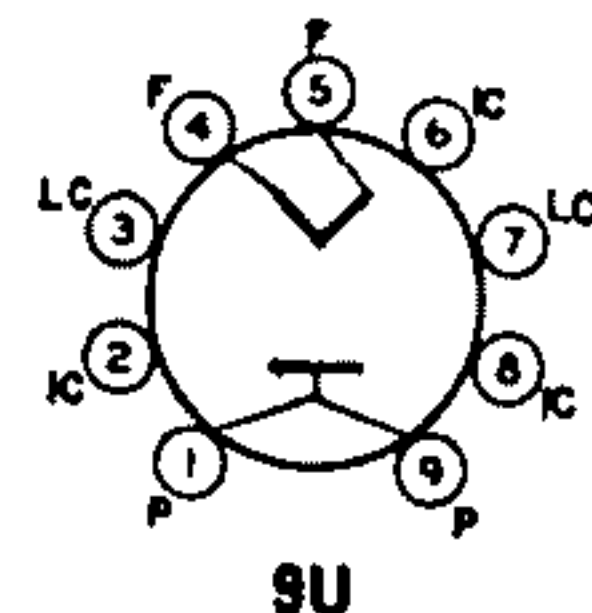
Tube Voltage Drop for plate current of 7 mA	100	volts
---	-----	-------

# Pulse duration must not exceed 15% of a horizontal scanning cycle (10 microseconds).  
\* The dc component must not exceed 24000 volts.

**2AV2**

**HALF-WAVE  
VACUUM RECTIFIER**

Miniature type used as a high-voltage, low-current pulse-operated focus rectifier in color television receivers. The filament of the tube can be operated directly across the filament winding of the horizontal-output transformer without a series voltage-dropping resistor. Outlines section, 6B; requires miniature 9-contact socket. For high-voltage and X-ray safety considerations, refer to type 1G3GT/1B3GT.



Filament Voltage (ac)	1.8	volts
Filament Current	0.225	ampere
Direct Interelectrode Capacitance (Approx.):		
Plate to Filament	0.8	pF

**Pulsed Rectifier**

For operation in a 525-line, 30-frame system

**MAXIMUM RATINGS (Design-Maximum Values)**

Peak Inverse Plate Voltage#	8250**	volts
Peak Plate Current	50	mA
Average Plate Current	0.6	mA

**CHARACTERISTICS, Instantaneous Value**

Tube Voltage Drop for plate current of 1 mA	20	volts
---	----	-------

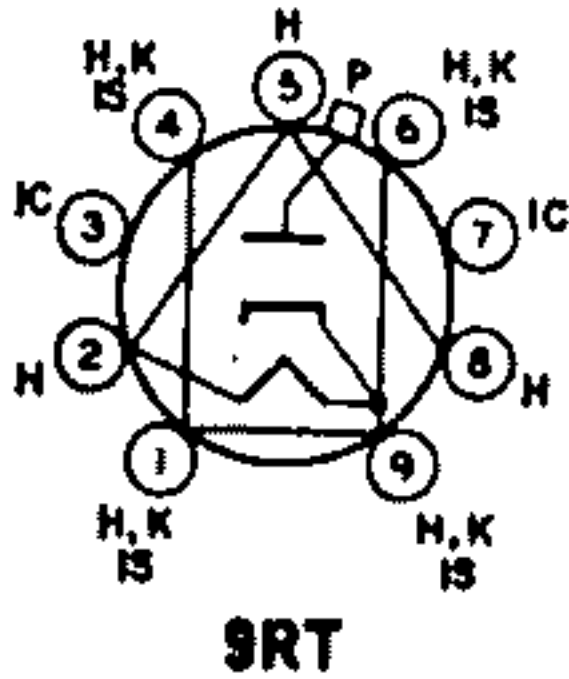
# Pulse duration must not exceed 15% of a horizontal scanning cycle (10 microseconds).  
 \*\* Under no circumstances should this absolute value be exceeded; the dc component must not exceed 7000 volts.

Refer to chart at end of section.

**2B7**

**HALF-WAVE  
VACUUM RECTIFIER**

**2BJ2**



**9SRT**

Miniature type used as a rectifier in high-voltage pulse circuits of transistorized black-and-white television receivers. Outlines section, 7A; requires miniature 9-contact socket. Socket terminals 3 and 7 should not be used as tie points for external-circuit connections. For high-voltage and X-ray safety considerations, refer to type 1G3GT./1B3GT.

Heater Voltage (ac/dc)	2.8	volts
Heater Current	0.3	ampere
Direct Interelectrode Capacitance:		
Plate to Cathode, Heater, and Internal Shield	1	pF

**Pulsed Rectifier**

For operation in a 525-line, 30-frame system

**MAXIMUM RATINGS (Design-Maximum Values)**

Peak Inverse Plate Voltage#	20000	volts
Peak Plate Current	80	mA
Average Plate Current	1	mA

**CHARACTERISTICS, Instantaneous Value**

Tube Voltage Drop for plate current of 7 mA	80	volts
---	----	-------

# Pulse duration must not exceed 15% of a horizontal scanning cycle (10 microseconds).

Refer to chart at end of section.

**2BN4**

Refer to type 6BN4A.

**2BN4A**

Refer to type 6CW4.

**2CW4**

Refer to type 6CY5.

**2CY5**

Refer to type 6DS4.

**2DS4**

Refer to type 6DV4.

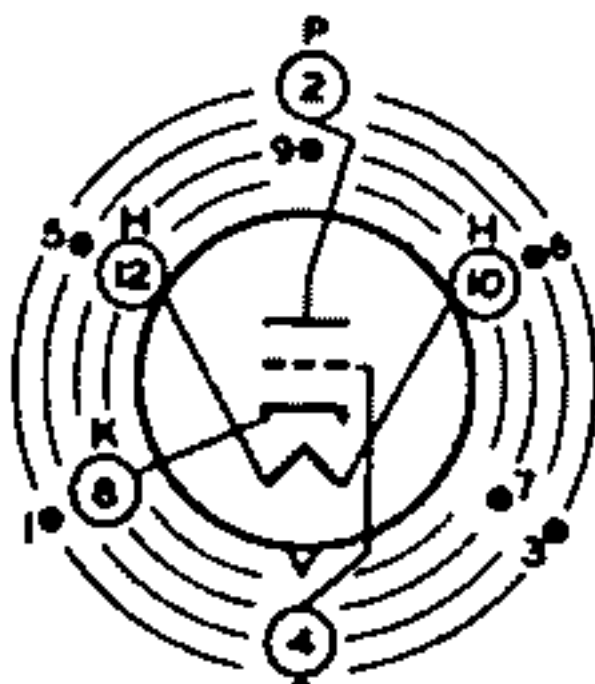
**2DV4**

Refer to type 6DZ4.

**2DZ4**

Refer to chart at end of section.

**2E5**



INDEX=LARGE LUG  
 ●=SHORT PIN—IC

**12AQ**

**HIGH-MU TRIODE**

**2EG4**

Novistor type used as a grounded-cathode, neutralized rf amplifier in vhf tuners of television and FM receivers. Outlines section, 1; requires novistor socket.

Heater Voltage (ac/dc)	1.7	volts
Heater Current	0.6	ampere



Heater Warm-up Time (Average) .....	8	seconds
Peak Heater-Cathode Voltage .....	±100	volts
Direct Interelectrode Capacitances (Approx.):		
Grid to Plate .....	0.92	pF
Grid to Cathode, Heater, and Shell .....	4.8	pF
Plate to Cathode, Heater, and Shell .....	1.8	pF
Plate to Cathode .....	0.18	pF
Heater to Cathode .....	1.6	pF

**Class A<sub>1</sub> Amplifier**

**MAXIMUM RATINGS (Design-Maximum Values)**

Plate Supply Voltage .....	300*	volts
Plate Voltage .....	135	volts
Grid Voltage:		
Negative-bias value .....	-55	volts
Peak or dc positive value .....	0	volts
Plate Dissipation .....	1.5	watts
Cathode Current .....	15	mA

**CHARACTERISTICS AND TYPICAL OPERATION**

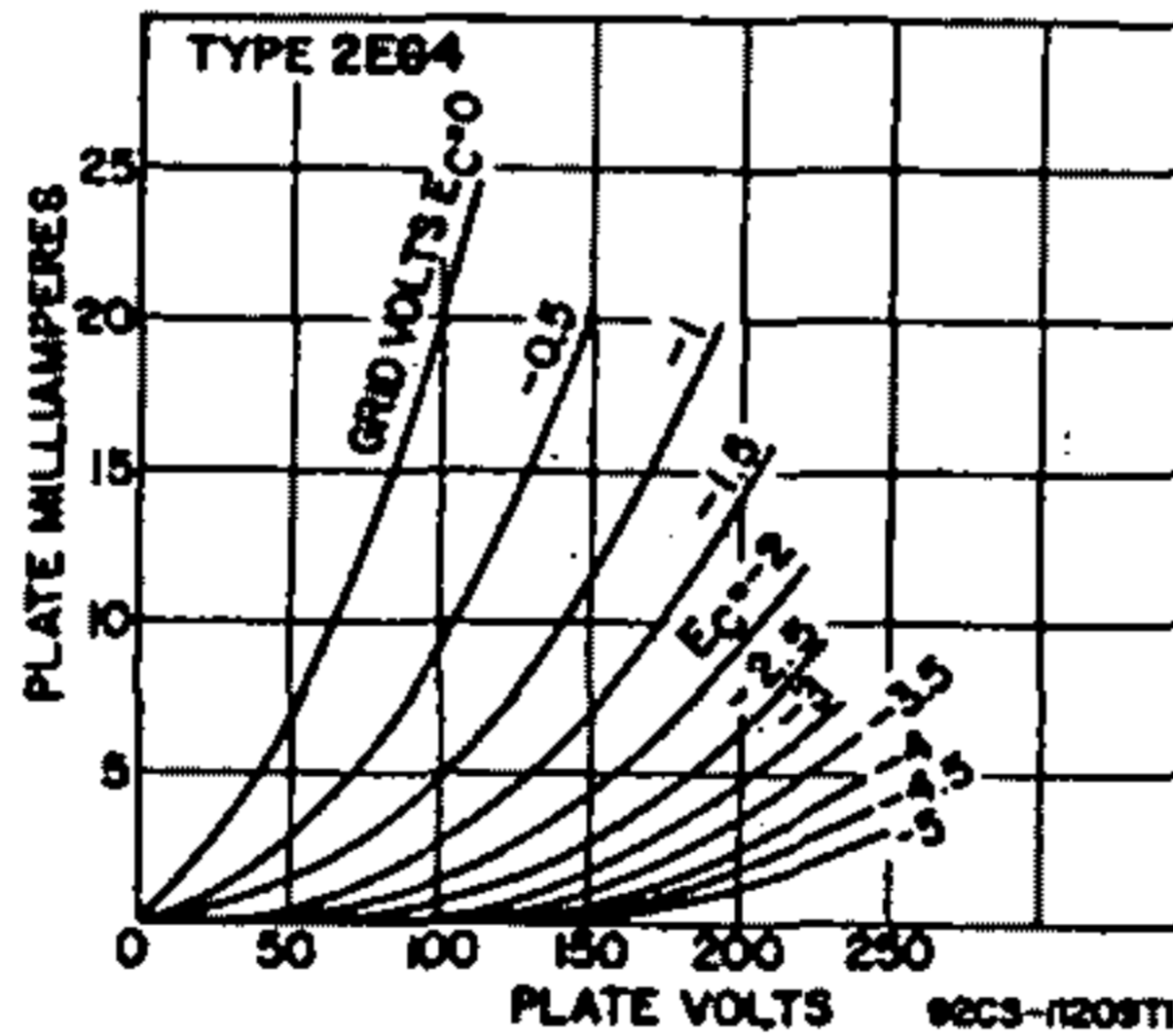
	Characteristics	Typical Operation	
Plate Supply Voltage .....	110	70	volts
Grid Supply Voltage .....	—	0	volts
Cathode-Bias Resistor .....	150	—	ohms
Grid Resistor .....	—	47000	ohms
Amplification Factor .....	68	68	
Plate Resistance (Approx.) .....	7000	5440	ohms
Transconductance .....	9000	12500	μmhos
Grid Voltage (Approx.) for plate current of 100 μA ..	-5	—	volts
Grid Voltage (Approx.) for plate current of 10 μA ..	-6.8	—	volts
Plate Current .....	6.5	7	mA

**MAXIMUM CIRCUIT VALUES**

Grid-Circuit Resistance:*		
For fixed-bias operation .....	0.5	megohms
For cathode-bias operation .....	2.2	megohms

\* A plate supply voltage of 300 volts may be used provided that a sufficiently large resistor is used in the plate circuit to limit the plate dissipation to 1.5 watts under any condition of operation.

\* For operation at metal-shell temperatures up to 135° C.

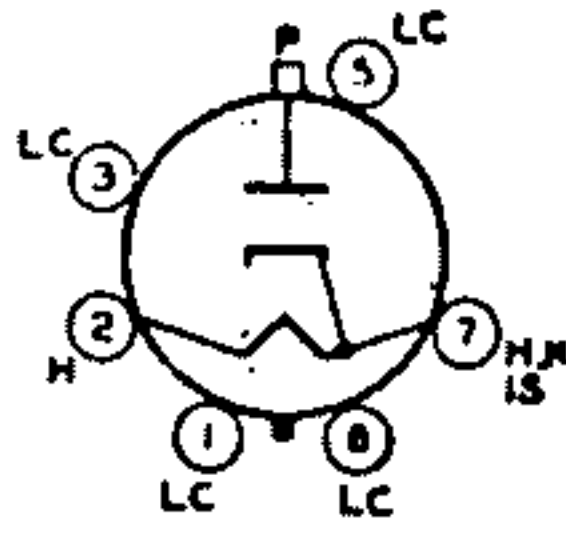


- 2EN5
- 2ER5
- 2FH5
- 2FQ5A
- 2F55
- 2GK5
- 2GU5
- 2HA5
- 2HQ5

- Refer to chart at end of section.
- Refer to type 6ER5.
- Refer to type 6FH5.
- Refer to type 6FQ5A.
- Refer to type 6F55.
- Refer to type 6GK5.
- Refer to type 6GU5.
- Refer to type 6HA5.
- Refer to type 6HQ5.

Refer to chart at end of section.  
 Refer to chart at end of section.

**3A2**  
**3A3**



**8EZ**

**HALF-WAVE  
 VACUUM RECTIFIER**

**3A3/3B2**  
**3A3A**  
**3A3A/3B2**

Glass octal type used as a rectifier in high-voltage pulse circuits of color television receivers. Outlines section, 14E; requires octal socket. Socket terminals 1, 3, 4, 5, 6, and 8 may be connected to socket terminal 7. Socket terminals 4 and 6 may be used as tie points for components at or near heater potential. For high-voltage and X-ray safety considerations, refer to type 1G3GT/1B3GT.

Heater Voltage (ac)	3.15*	volts
Heater Current	0.22	ampere
Direct Interelectrode Capacitance (Approx.):		
Plate to Heater, Cathode, and Internal Shield	1.5	pF

\* Under no circumstances should the heater voltage be less than 2.55 volts or greater than 3.65 volts.

**Pulsed Rectifier**

For operation in a 525-line, 30-frame system

**MAXIMUM RATINGS (Design-Maximum Values)**

	3A3A 3A3A/3B2	3A3/3B2	
Peak Inverse Plate Voltage#	30000	30000	volts
Peak Plate Current	100	88	mA
Average Plate Current	2	1.7	mA

# Pulse duration must not exceed 15% of a horizontal scanning cycle (10 microseconds).

Refer to chart at end of section.

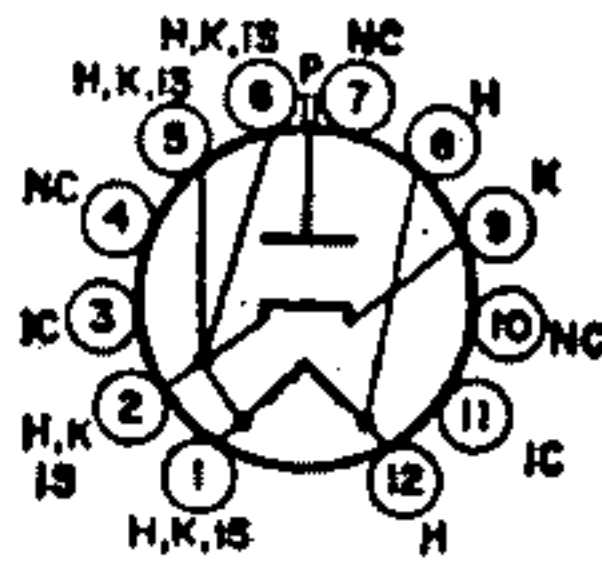
**3A8GT**

Refer to type 6AF4A.

**3AF4A**

Refer to type 6AL5.

**3AL5**



**12FV**

**HALF-WAVE  
 VACUUM RECTIFIER**

**3AT2**

Duodecar type used as a rectifier in high-voltage pulse circuits of color television receivers. Outlines section, 9B; requires duodecar 12-contact socket. For high-voltage and X-ray safety considerations, refer to type 1G3GT/1B3GT.

Heater Voltage (ac/dc)	3.15	volts
Heater Current	0.22	ampere
Direct Interelectrode Capacitance:		
Plate to Cathode, Heater, and Internal Shield	1.5	pF

**Pulsed Rectifier**

For operation in a 525-line, 30-frame system

**MAXIMUM RATINGS (Design-Maximum Values)**

	30000	volts
Peak Inverse Plate Voltage#	30000	volts
Peak Plate Current	88	mA
Average Plate Current	1.7	mA

# Pulse duration must not exceed 15% of a horizontal scanning cycle (10 microseconds).

Refer to type 6AU6A.

**3AU6**

Refer to type 6AV6.

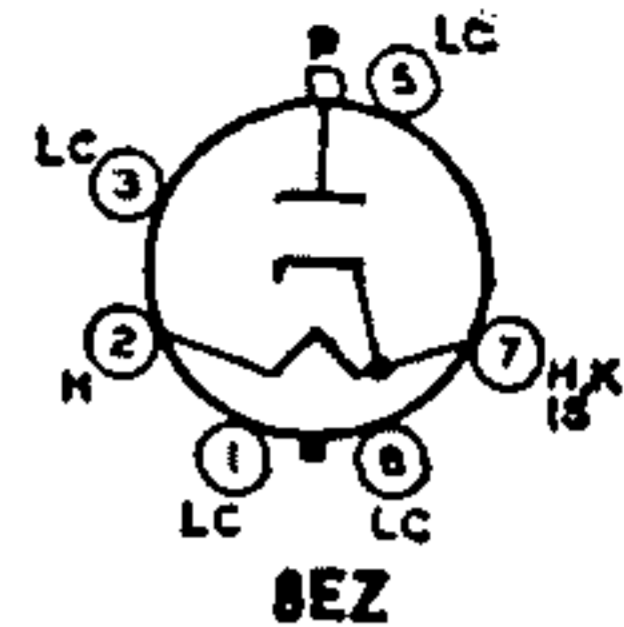
**3AV6**



### 3AW3

### HALF-WAVE VACUUM RECTIFIER

Glass octal type used as a rectifier in high-voltage pulse circuits of black-and-white television receivers. Outlines section, 14B; requires octal socket. For high-voltage and X-ray safety considerations, refer to type 1G3GT/1B3GT. Heater: volts (ac/dc), 3.15; amperes, 0.22.



#### Pulsed Rectifier

For operation in a 525-line, 30-frame system

#### MAXIMUM RATINGS (Design-Maximum Values)

Peak Inverse Plate Voltage#	30000	volts
Peak Plate Current	88	mA
Average Plate Current	1.7	mA

# Pulse duration must not exceed 15% of a horizontal scanning cycle (10 microseconds).

#### 3B2

Refer to chart at end of section.

#### 3BA6

Refer to type 6BA6.

#### 3BC5

Refer to type 6BC5.

#### 3BC5/3CE5

#### 3BE6

Refer to type 6BE6.

#### 3BN4

Refer to chart at end of section.

#### 3BN4A

Refer to type 6BN4A.

#### 3BN6

Refer to type 6BN6.

#### 3BU8

Refer to type 6BU8.

#### 3BU8/3GS8

#### 3BY6

Refer to type 6BY6.

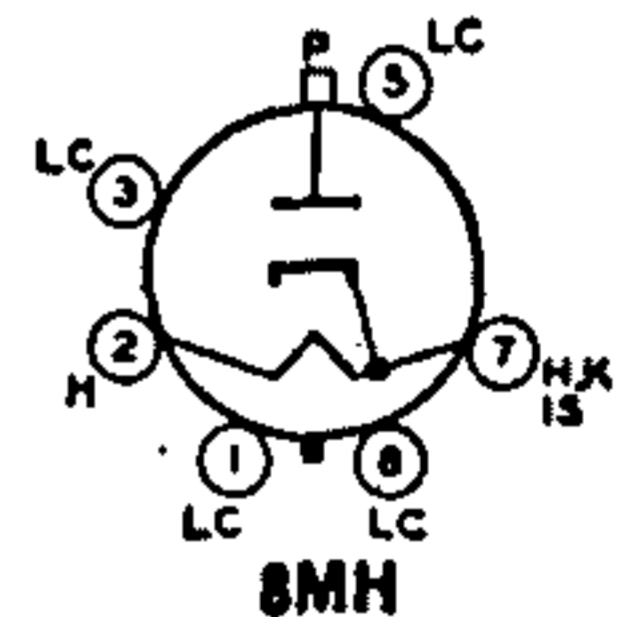
#### 3BZ6

Refer to type 6BZ6.

### 3CA3

### HALF-WAVE VACUUM RECTIFIER

Glass octal type used as a rectifier in high-voltage pulse circuits of color television receivers. Outlines section, 14E; requires octal socket. Socket terminals 1, 3, 4, 5, 6, and 8 may be connected to terminal 7 or to a corona shield which connects to terminal 7. Socket terminals 4 and 6 may be used as tie points at or near cathode potential. For high-voltage and X-ray safety considerations, refer to type 1G3GT/1B3GT.



Heater Voltage (ac)	3.6	volts
Heater Current	0.225	ampere
Direct Interelectrode Capacitance (Approx.):		
Plate to Heater, Cathode, and Internal Shield	1.6	pF

#### Pulsed Rectifier

For operation in a 525-line, 30-frame system

#### MAXIMUM RATINGS (Design-Maximum Values)

Peak Inverse Plate Voltage#	30000	volts
Peak Plate Current	100	mA
Average Plate Current	2	mA

#### CHARACTERISTICS, Instantaneous Value

Tube Voltage Drop for plate current of 11 mA	100	volts
--	-----	-------

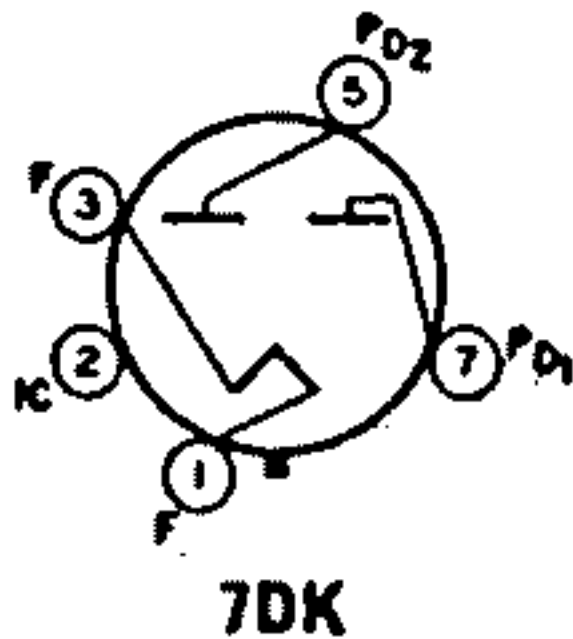
# Pulse duration must not exceed 15% of a horizontal scanning cycle (10 microseconds).

#### 3CB6

Refer to type 6CB6A.

Refer to type 6CE5.  
 Refer to type 6CF6.  
 Refer to type 6CS6.  
 Refer to type 6CY5.

**3CE5**  
**3CF6**  
**3CS6**  
**3CY5**



**FULL-WAVE  
 VACUUM RECTIFIER**

**3DG4**

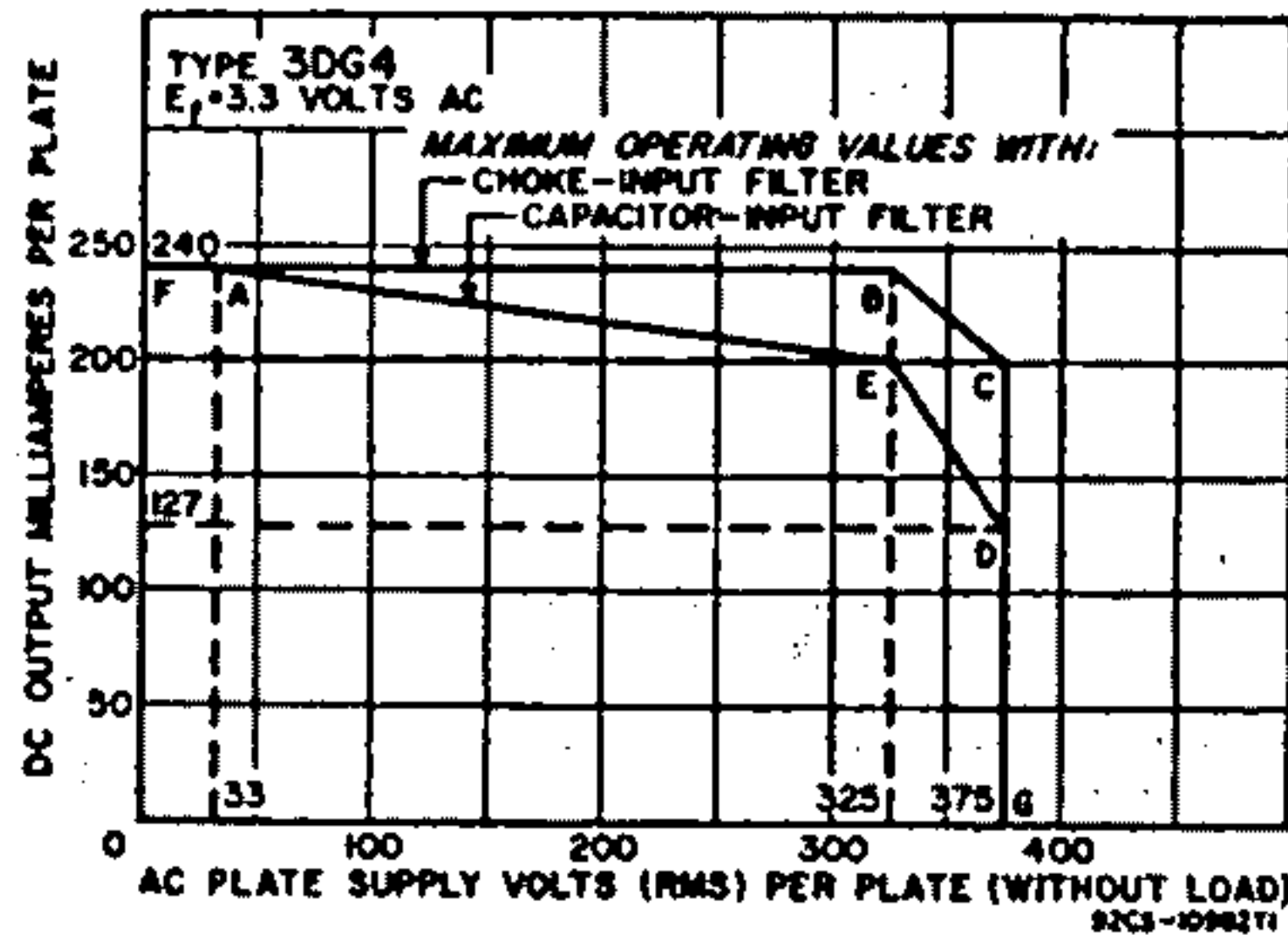
Glass octal type used in power supplies of color and black-and-white television receivers and other equipment having high dc requirements. Outlines section, 19E; requires octal socket. It is especially important that this tube, like other power-handling tubes, be adequately ventilated. For discussion of Rating Chart, refer to Interpretation of Tube Data. Filament: volts (ac/dc), 3.3; amperes, 3.8.

**Full-Wave Rectifier**

**MAXIMUM RATINGS (Design-Maximum Values)**

Peak Inverse Plate Voltage .....	1050	volts
Peak Plate Current (Per Plate) .....	1.2	amperes
Hot-Switching Transient Plate Current (Per Plate) .....	6.5	amperes
AC Plate Supply Voltage (Per Plate, rms) .....	See Rating Chart	
DC Output Current (Per Plate) .....	See Rating Chart	
Bulb Temperature (at hottest point on bulb surface) .....	200	°C

**RATING CHART**



**TYPICAL OPERATION WITH CAPACITOR INPUT TO FILTER**

AC Plate-to-Plate Supply Voltage (rms) .....	550	volts
Filter-Input Capacitor* .....	40	µF
Effective Plate-Supply Impedance per Plate .....	32	ohms
DC Output Voltage at Input to Filter (Approx.):		
At full-load current of 350 mA .....	300	volts

**CHARACTERISTICS**

Tube Voltage Drop for plate current of 350 mA (per plate) .....	25	volts
---	----	-------

\* Higher values of capacitance than indicated may be used, but the effective plate-supply impedance may have to be increased to prevent exceeding the maximum peak-plate-current rating.

Refer to type 6DK6.  
 Refer to chart at end of section.  
 Refer to type 6DT6A.  
 Refer to type 6DZ4.  
 Refer to chart at end of section.  
 Refer to type 6EH7.

**3DK6**  
**3DT6**  
**3DT6A**  
**3DZ4**  
**3EA5**  
**3EH7**

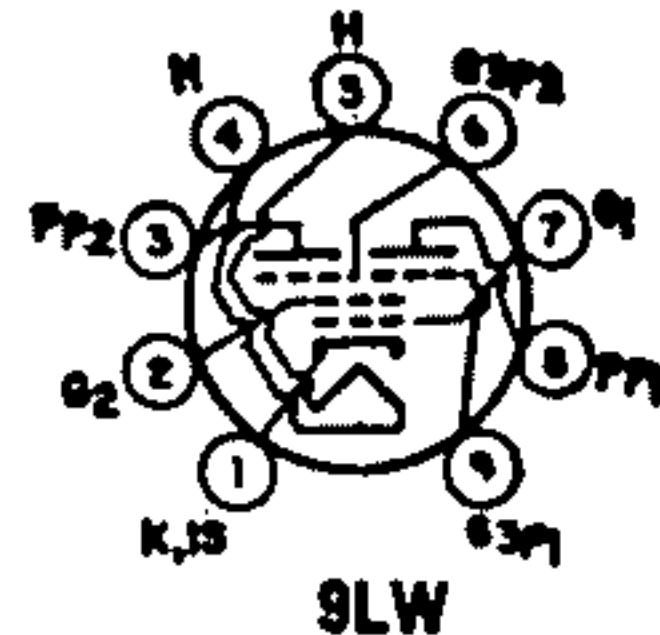


<b>3EJ7</b>	Refer to type 6EJ7/EF184.
<b>3ER5</b>	Refer to type 6ER5.
<b>3FH5</b>	Refer to type 6FH5.
<b>3FS5</b>	Refer to type 6FS5.
<b>3GK5</b>	Refer to type 6GK5.

**3GS8**

**SHARP-CUTOFF  
TWIN PENTODE**

Miniature type used as combined sync separator, sync clipper, and agc amplifier tube in television receivers. Outlines section, 6E; requires miniature 9-contact socket.



Heater Voltage (ac/dc)	3.15	volts
Heater Current	0.6	ampere
Heater Warm-Up Time (Average)	11	seconds
Heater-Cathode Voltage:		
Peak value	±200 max	volts
Average value	100 max	volts
Direct Interelectrode Capacitances:		
Grid No.3 to Plate (Each Unit)	2	pF
Grid No.1 to All Other Electrodes	6	pF
Grid No.2 to All Other Electrodes (Each Unit)	3.8	pF
Plate to All Other Electrodes (Each Unit)	3.2	pF
Grid No.3 of Unit No.1 to Grid No.3 of Unit No.2	0.015 max	pF

**Class A<sub>1</sub> Amplifier**

**MAXIMUM RATINGS (Design-Maximum Values)**

Plate Voltage (Each Unit)	300	volts
Grid-No.3 (Suppressor-Grid) Voltage (Each Unit):		
Peak positive value	50	volts
DC negative value	-50	volts
DC positive value	3	volts
Grid-No.2 (Screen-Grid) Voltage	150	volts
Grid-No.1 (Control-Grid) Voltage, Negative bias value	-50	volts
Cathode Current	12	mA
Plate Dissipation (Each Unit)	1.1	watts
Grid-No.2 Input	0.75	watt

**CHARACTERISTICS**

	<b>With Both Units Operating</b>		
Plate Voltage (Each Unit)	100	100	volts
Grid-No.3 Voltage (Each Unit)	-10	0	volts
Grid-No.2 Voltage	67.5	67.5	volts
Grid-No.1 Voltage	•	•	volts
Plate Current (Each Unit)	—	2	mA
Grid-No.2 Current	6	3.6	mA
Cathode Current	6.1	7.7	mA

	<b>With One Unit Operating*</b>		
Plate Voltage	100	100	volts
Grid-No.3 Voltage	0	0	volts
Grid-No.2 Voltage	67.5	67.5	volts
Grid-No.1 Voltage	0	•	volts
Grid-No.3 Transconductance	—	270	μmhos
Grid-No.1 Transconductance	1200	—	μmhos
Plate Current	—	2	mA
Grid-No.3 Voltage (Approx.) for plate current of 100 μA	—	-3.7	volts
Grid-No.1 Voltage (Approx.) for plate current of 100 μA	—	-2	volts

**MAXIMUM CIRCUIT VALUES**

Grid-No.3-Circuit Resistance (Each Unit)	0.5	megohm
Grid-No.1-Circuit Resistance	0.5	megohm

\* Adjusted to provide a dc grid-No.1 current of 100 microamperes.

• With plate and grid No.3 of the other unit connected to ground

**3GS8/3BU8**

Refer to chart at end of section.

**3HA5**

Refer to chart at end of section.

Refer to type 6HM5/6HA5.	<b>3HM5/3HA5</b>
Refer to type 6HQ5.	<b>3HQ5</b>
Refer to type 6HS8.	<b>3HS8</b>
Refer to types 6JC6 and 6JC6A.	<b>3JC6</b>
	<b>3JC6A</b>
Refer to type 6JD6.	<b>3JD6</b>
Refer to type 6KT6.	<b>3KT6</b>
Refer to chart at end of section.	<b>3LF4</b>
Refer to chart at end of section.	<b>3Q4</b>
Refer to chart at end of section.	<b>3Q5GT</b>
Refer to chart at end of section.	<b>3S4</b>
Refer to chart at end of section.	<b>3V4</b>
Refer to type 6AU6A.	<b>4AU6</b>
Refer to type 6AV6.	<b>4AV6</b>
Refer to chart at end of section.	<b>4BC5</b>
Refer to type 6BC8.	<b>4BC8</b>
Refer to type 6BL8.	<b>4BL8</b>
	<b>4BL8/XCF80</b>
Refer to type 6BN6.	<b>4BN6</b>
Refer to type 6BQ7A.	<b>4BQ7A</b>
Refer to type 6BS8.	<b>4BS8</b>
Refer to chart at end of section.	<b>4BU8</b>
	<b>4BU8/4GS8</b>
Refer to type 6BZ6.	<b>4BZ6</b>
Refer to type 6BZ7.	<b>4BZ7</b>
Refer to type 6CB6A.	<b>4CB6</b>
Refer to type 6CS6.	<b>4CS6</b>
Refer to type 6CY5.	<b>4CY5</b>
Refer to type 6DE6.	<b>4DE6</b>
Refer to type 6DK6.	<b>4DK6</b>
Refer to chart at end of section.	<b>4DT6</b>
Refer to type 6DT6A.	<b>4DT6A</b>
Refer to type 6EH7.	<b>4EH7</b>
Refer to type 6EJ7/EF184.	<b>4EJ7</b>
Refer to type 6ES8.	<b>4ES8</b>
Refer to type 6EW6.	<b>4EW6</b>
Refer to type 6GK5.	<b>4GK5</b>
Refer to type 6GM6.	<b>4GM6</b>
Refer to chart at end of section.	<b>4GS8</b>
	<b>4GS8/4BU8</b>
Refer to type 6GX7.	<b>4GX7</b>



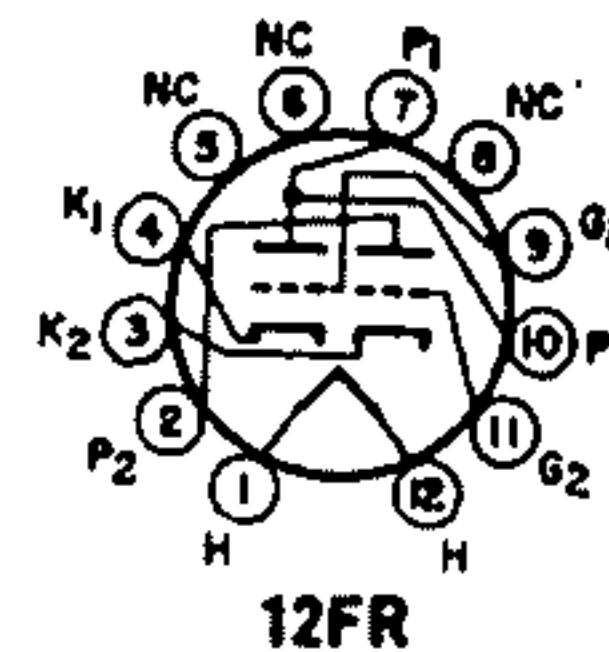
**4GZ5**  
**4HA5**  
**4HA7**

Refer to type 6GZ5.  
 Refer to type 6HA5.  
 Refer to type 5HA7.

**4HC7**

**DUAL TRIODE**

Duodecar type used for sync clipper and agc-amplifier service in television receivers. Outlines section, 30E; requires duodecar 12-contact socket. Heater: volts (ac/dc), 4.2; amperes, 0.6; warm-up time, 11 seconds; maximum heater-cathode volts,  $\pm 200$  peak, 100 average.



**Class A<sub>1</sub> Amplifier**

MAXIMUM RATINGS (Design-Maximum Values)	Unit No.1	Unit No.2	
Plate Voltage	330	330	volts
Grid Voltage:			
Positive-bias value	0	0	volts
Negative-bias value	-100	-100	volts
Peak Positive-Pulse Grid Voltage	60	—	volts
Plate Dissipation <sup>#</sup>	3	1.2	watts
<b>CHARACTERISTICS</b>			
Plate Voltage	150	150	volts
Grid Voltage	-1	-1	volt
Amplification Factor	28	100	
Plate Resistance (Approx.)	5200	58000	ohms
Transconductance	4400	1900	$\mu$ mhos
Plate Current	18	1	mA
Grid Voltage (Approx.) for plate current of 10 $\mu$ A	-13	-2.2	volts
<b>MAXIMUM CIRCUIT VALUE</b>			
Grid-Circuit Resistance	5	5	megohms

<sup>#</sup> A bias resistor or other means is required to protect the tube in absence of excitation.

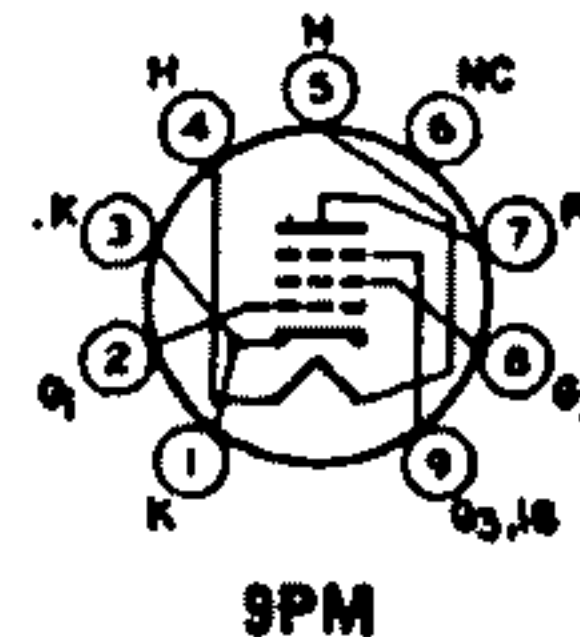
**4HM6**  
**4HS8**

Refer to type 6HM6.  
 Refer to type 6HS8.

**4HT6**

**SEMIREMOTE-CUTOFF  
 PENTODE**

Miniature type with frame grid used in the if-amplifier stage of television receivers. Outlines section, 6B; requires miniature 9-contact socket.



Heater Voltage (ac/dc)	4.2	volts	
Heater Current	0.45	ampere	
Heater Warm-up Time	11	seconds	
Heater-Cathode Voltage			
Peak value	$\pm 200$ max	volts	
Average value	100 max	volts	
Direct Interelectrode Capacitances:	Unshielded	Shielded	
Grid No.1 to Plate	0.031	0.024	pF
Grid No.1 to Cathode, Heater, Grid No.2, Grid No.3, and Internal Shield	8.7	8.7	pF
Plate to Cathode, Heater, Grid No.2, Grid No.3, and Internal Shield	2.15	3.0	pF
<b>MAXIMUM RATINGS (Design-Maximum Values)</b>			
Plate Voltage	250	volts	
Grid-No.2 (Screen-Grid) Supply Voltage	250	volts	
Grid-No.2 Voltage	See curve page 96		
Grid-No.1 (Control-Grid) Voltage, Negative-bias value	-50	volts	
Cathode Current	25	mA	
Plate Dissipation	2.5	watts	
Grid-No.2 Input:			
For grid-No.2 voltages up to 125 volts	0.6	watt	
For grid-No.2 voltages between 125 and 250 volts	See curve page 96		

**CHARACTERISTICS**

Plate Supply Voltage .....	125	volts
Grid No.3 (Suppressor Grid) .....	Connected to cathode at socket	
Grid-No.2 Supply Voltage .....	125	volts
Cathode-Bias Resistor .....	50	ohms
Plate Resistance (Approx.) .....	0.143	megohm
Transconductance .....	14000	$\mu$ mhos
Plate Current .....	15	mA
Grid-No.2 Current .....	4	mA
Grid-No.1 Voltage (Approx.) for transconductance of 100 $\mu$ mhos ..	-4.5	volts
<b>MAXIMUM CIRCUIT VALUE</b>		
Grid-No.1-Circuit Resistance:		
For fixed-bias operation .....	0.25	megohm
For cathode-bias operation .....	1	megohm

Refer to types 6JC6 and 6JC6A.

Refer to type 6JD6.

Refer to type 6KE8.

Refer to type 6KT6.

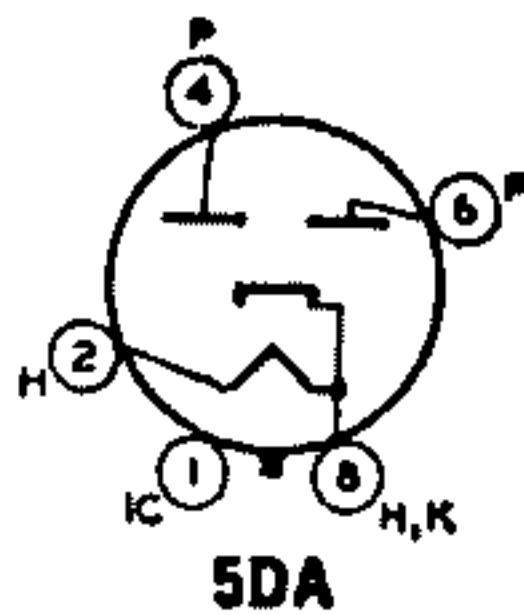
Refer to type 5LJ8.

Refer to type 6AM8A.

Refer to type 6AN8A.

Refer to type 6AQ5A.

**4JC6**  
**4JC6A**  
**4JD6**  
**4KE8**  
**4KT6**  
**4LJ8**  
**5AM8**  
**5AN8**  
**5AQ5**  
**5AR4/**  
**GZ34**



**FULL-WAVE VACUUM RECTIFIER**

Glass octal type used in power supply of television receivers and other equipment having high dc requirements. Outlines section, 13F; requires octal socket. It is especially important that this tube, like other power-handling tubes, be adequately ventilated. Heater: volts (ac/dc), 5; amperes, 1.9.

**Full-Wave Rectifier**

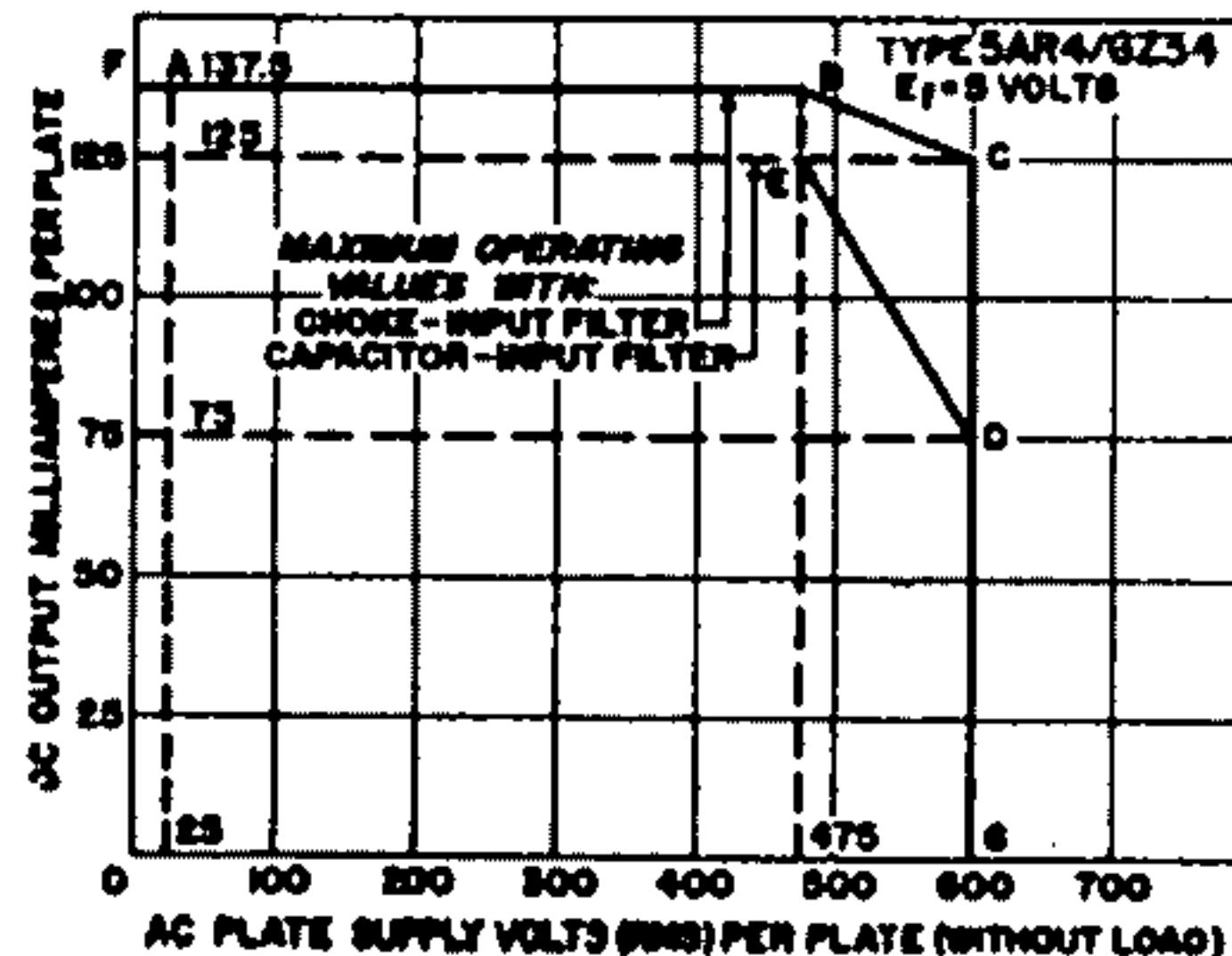
**MAXIMUM RATINGS (Design-Maximum Values)**

Peak Inverse Plate Voltage .....	1700	volts
Peak Plate Current (Per Plate) .....	825	mA
Hot-Switching Transient Plate Current (Per Plate) .....	3.7	amperes
AC Plate-Supply Voltage (Per Plate, rms, without load) .....	See Rating Chart	
Average Output Current (Per Plate) .....	See Rating Chart	

**TYPICAL OPERATION WITH CAPACITOR INPUT TO FILTER**

AC Plate-to-Plate Supply Voltage (rms) .....	450	550	volts
Effective Plate-Supply Impedance per Plate .....	160	200	ohms
Average Output Current .....	225	160	mA
DC Output Voltage at Input to Filter .....	475	620	volts

**RATING CHART**





**TYPICAL OPERATION WITH CHOKE INPUT TO FILTER**

AC Plate-to-Plate Supply Voltage (rms) .....	450	550	volts
Filter Input Choke .....	10	10	henries
Average Output Current .....	250	225	mA
DC Output Voltage at Input to Filter .....	375	465	volts
<b>CHARACTERISTICS, Instantaneous Value</b>			
Tube Voltage Drop for plate current of 225 mA (Per Plate) .....	—	17	volts

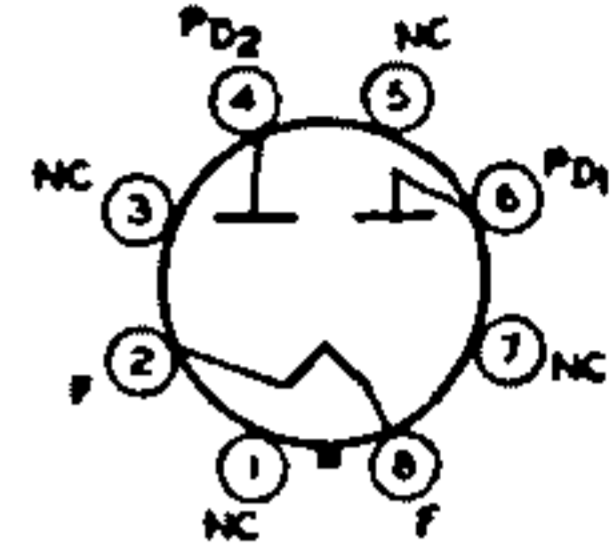
**5AS4**

Refer to chart at end of section.

**5AS4A**

**FULL-WAVE  
VACUUM RECTIFIER**

Glass octal type used in power supplies of television receivers having high dc requirements. Outlines section, 19D; requires octal socket. This type may be supplied with pins 3, 5, and 7 omitted. Vertical mounting is preferred, but horizontal mounting is permissible if pins 1 and 4 are in vertical plane. It is especially important that this tube, like other power-handling tubes, be adequately ventilated. Heater: volts (ac), 5.0; amperes, 3.0. For maximum ratings, typical operation, and curves, refer to type 5U4GB.



**5T**

**5AS8**

Refer to type 6AS8.

**5AT8**

Refer to type 6AT8A.

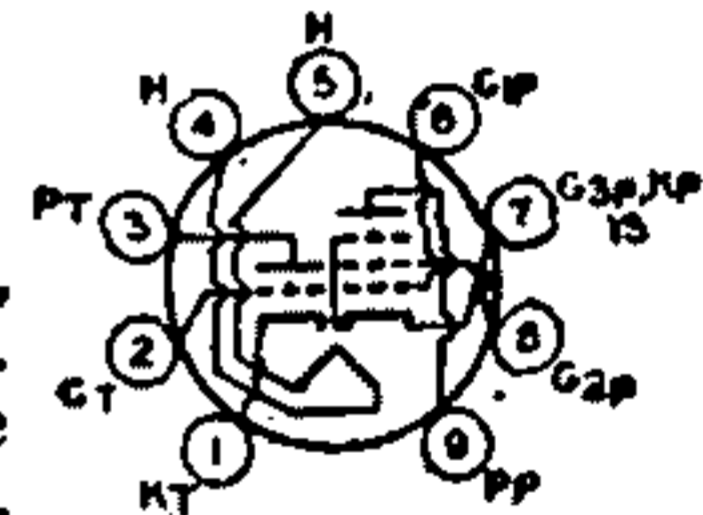
**5AU4**

Refer to chart at end of data section.

**5AV8**

**MEDIUM-MU TRIODE—  
SHARP-CUTOFF PENTODE**

Miniature type used in television receiver applications, Outlines section, 6B; requires miniature 9-contact socket. Heater: volts (ac/dc), 4.7; amperes, 0.6; warm-up time (average), 11 seconds; maximum heater-cathode volts, ± 200 peak, 100 average.



**9DZ**

**Class A<sub>1</sub> Amplifier**

**MAXIMUM RATINGS (Design-Center Values)**

	Triode Unit	Pentode Unit	
Plate Voltage .....	800	300	volts
Grid No.2 Supply Voltage .....	—	300	volts
Grid-No.2 (Screen-Grid) Voltage .....	—	See curve page 96	
Grid-No.1 (Control-Grid) Voltage, Positive-bias value .....	0	0	volts
Plate Dissipation .....	2.5	2	watts
Grid-No.2 Input:			
For grid-No.2 voltages up to 150 volts .....	—	0.5	watt
For grid-No.2 voltages between 150 and 300 volts .....	—	See curve page 96	

**CHARACTERISTICS**

Plate Supply Voltage .....	200	200	volts
Grid-No.2 Supply Voltage .....	—	150	volts
Grid-No.1 Voltage .....	—6	—	volts
Cathode-Bias Resistor .....	—	180	ohms
Amplification Factor .....	19	—	
Plate Resistance (Approx.) .....	5750	300000	ohms
Transconductance .....	3800	6200	μmhos
Plate Current .....	18	9.5	mA
Grid-No.2 Current .....	—	2.8	mA
Grid-No.1 Voltage (Approx.) for plate current of 10 μA .....	—18	—8	volts

**MAXIMUM CIRCUIT VALUES**

Grid-No.1-Circuit Resistance:*			
For fixed-bias operation .....	0.5	0.25	megohm
For cathode-bias operation .....	1.0	1.0	megohm

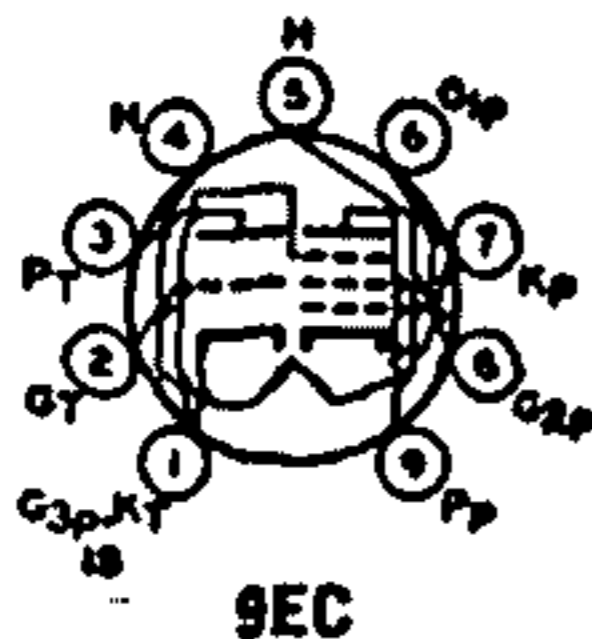
\* If either unit is operating at maximum rated conditions, grid-No.1-circuit resistance for both units should not exceed the stated values.

Refer to chart at end of section.

**5AW4**

Refer to chart at end of section.

**5AZ4**



**MEDIUM-MU TRIODE—  
SHARP-CUTOFF PENTODE**

**5B8**

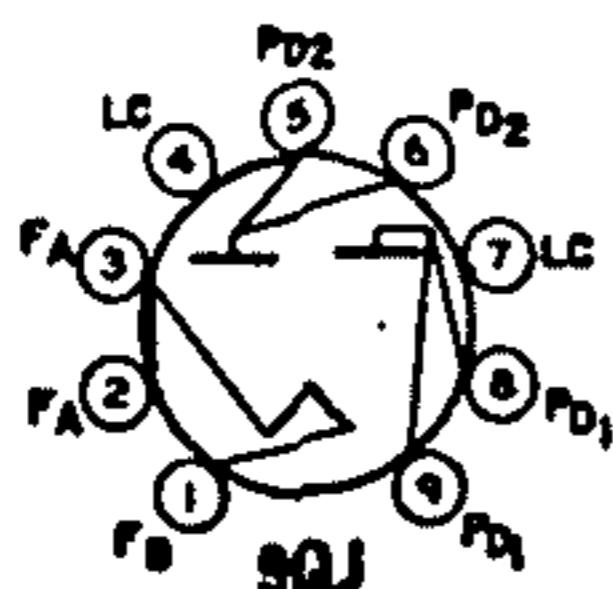
Miniature type used as combined vhf oscillator and mixer in television receivers. Outlines section, 6B; requires miniature 9-contact socket.

Heater Voltage (ac/dc)	4.7	volts
Heater Current	0.6	ampere
Heater Warm-up Time	11	seconds
Heater-Cathode Voltage:		
Peak value	±200 max	volts
Average value	100 max	volts
Direct Interelectrode Capacitances:		
Triode Unit:		
Grid to Plate	1.7	pF
Grid to Cathode, Heater, Pentode Grid No.3, and Internal Shield	1.9	pF
Plate to Cathode, Heater, Pentode Grid No.3, and Internal Shield	1.4	pF
Pentode Unit:		
Grid No.1 to Plate	0.05 max	pF
Grid No.1 to Cathode, Heater, and Grid No.2	6	pF
Plate to Cathode, Heater, Grid No.2, and Internal Shield	2.6	pF
Plate to Cathode, Heater, and Grid No.2	0.15	pF
Triode Grid to Pentode Plate	0.0078	pF
Pentode Grid No.1 to Triode Plate	0.0083	pF
Pentode Plate to Triode Plate	0.06	pF

**Class A<sub>1</sub> Amplifier**

MAXIMUM RATINGS (Design-Center Values)	Triode Unit	Pentode Unit	
Plate Voltage	300	300	volts
Grid No.2 (Screen-Grid) Supply Voltage	—	300	volts
Grid-No.2 Voltage	—	See curve page 96	
Grid-No.1 (Control-Grid) Voltage, Positive-bias value	0	0	volts
Plate Dissipation	2.5	2	watts
Grid No.2 Input:			
For grid-No.2 voltages up to 150 volts	—	0.5	watt
For grid-No.2 voltages between 150 and 300 volts	—	See curve page 96	
<b>CHARACTERISTICS</b>			
Plate Supply Voltage	200	200	volts
Grid-No.2 Supply Voltage	—	150	volts
Grid Voltage	—6	—	volts
Cathode-Bias Resistor	—	180	ohms
Amplification Factor	19	—	
Plate Resistance (Approx.)	5750	30000	ohms
Transconductance	3300	6200	μmhos
Plate Current	13	9.5	mA
Grid-No.2 Current	—	2.8	mA
Grid-No.1 Voltage (Approx.) for plate current of 10 μA	—19	—8	volts
<b>MAXIMUM CIRCUIT VALUE</b>			
Grid-No.1-Circuit Resistance*:			
For fixed-bias operation	0.5	0.25	megohm
For cathode-bias operation	1.0	1.0	megohm

\* If either unit is operated at maximum rated conditions, grid-No.1-circuit resistance for both units should not exceed the stated values.



**FULL-WAVE  
VACUUM RECTIFIER**

**5BC3  
5BC3A**

Novar types used in power supplies of radio equipment and television receivers having high dc requirements. Outlines section, 17C and 31C, respectively; re-



quire novar 9-contact socket. Vertical operation is preferred, but tubes may be operated in horizontal position if pins 2 and 7 are in vertical plane. It is especially important that these tubes, like other power-handling tubes, be adequately ventilated. Filament: volts (ac), 5; amperes, 3.

**Full-Wave Rectifier**

**MAXIMUM RATINGS (Design-Maximum Values)**

Peak Inverse Plate Voltage .....	1700	volts
Peak Plate Current (Per Plate) .....	1	ampere
Hot-Switching Transient Plate Current (Per Plate)* .....	5	amperes
AC Plate-Supply Voltage (Per Plate, rms) .....	See Rating Chart	
Average Output Current (Per Plate) .....	See Rating Chart	

**TYPICAL OPERATION WITH CAPACITOR INPUT TO FILTER**

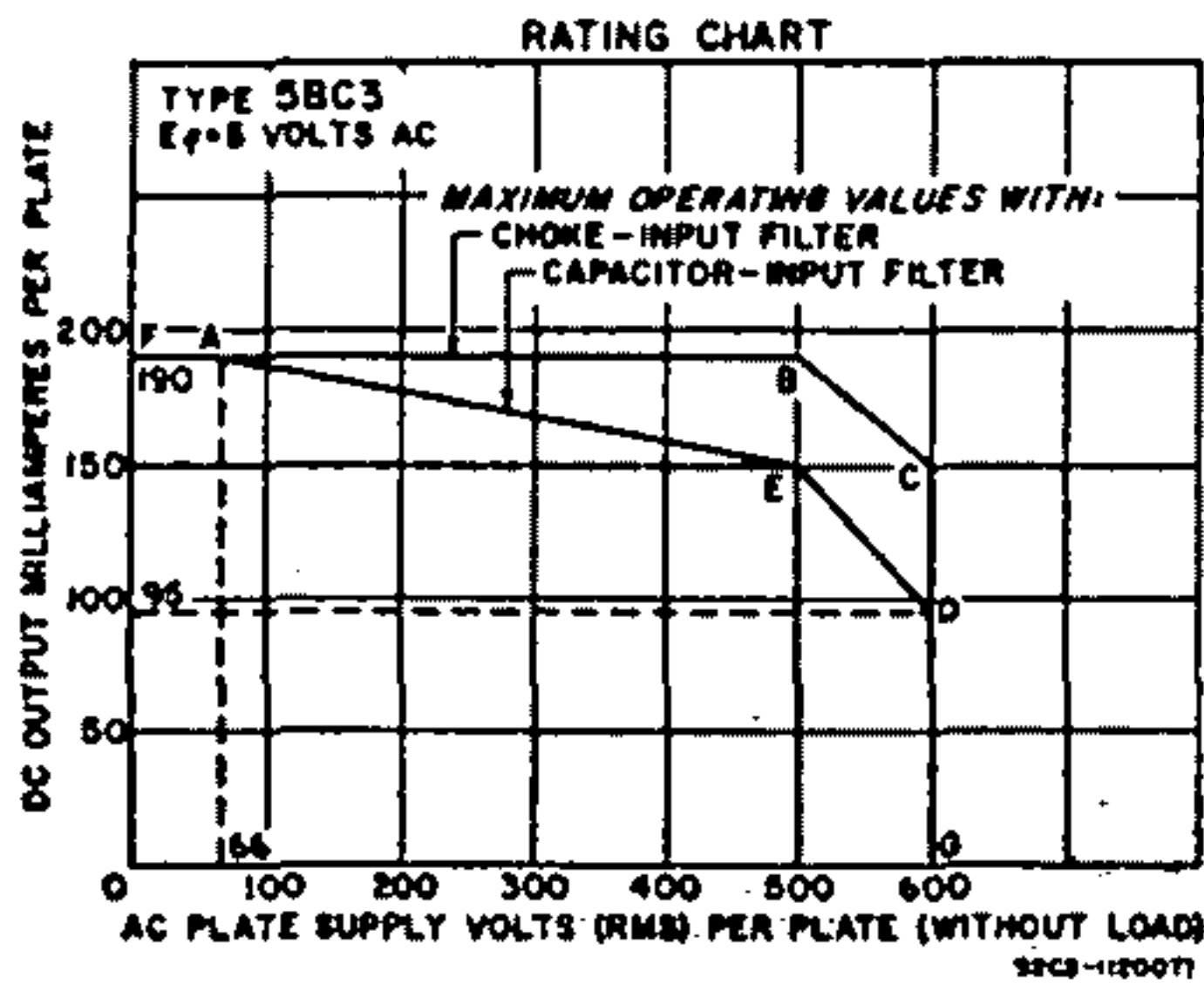
AC Plate-to-Plate Supply Voltage (rms) .....	600	900	1100	volts
Filter-Input Capacitor* .....	40	40	40	$\mu$ F
Total Effective Plate-Supply Impedance per Plate				
DC Output Voltage at Input to Filter (Approx.):	21	67	97	ohms
At load current of: 300 mA .....	290	—	—	volts
275 mA .....	—	460	—	volts
162 mA .....	—	—	630	volts
150 mA .....	385	—	—	volts
137.5 mA .....	—	520	—	volts
81 mA .....	—	—	680	volts

**TYPICAL OPERATION WITH CHOKE INPUT TO FILTER**

AC Plate-to-Plate Supply Voltage (rms) .....	900	1100	volts
Filter-Input Choke .....	10	10	henries
DC Output Voltage at Input to Filter (Approx.):			
At load current of: 348 mA .....	340	—	volts
275 mA .....	—	440	volts
174 mA .....	355	—	volts
137.5 mA .....	—	445	volts

\* If hot switching is regularly required in operation, the use of choke-input circuits is recommended. Such circuits limit the hot-switching current to a value no higher than that of the peak plate current. When capacitor-input circuits are used, a maximum peak current value per plate of 5 amperes during the initial cycles of the hot-switching transient should not be exceeded.

\* Higher values of capacitance than indicated may be used, but the effective plate-supply impedance may have to be increased to prevent exceeding the maximum rating for peak plate current.

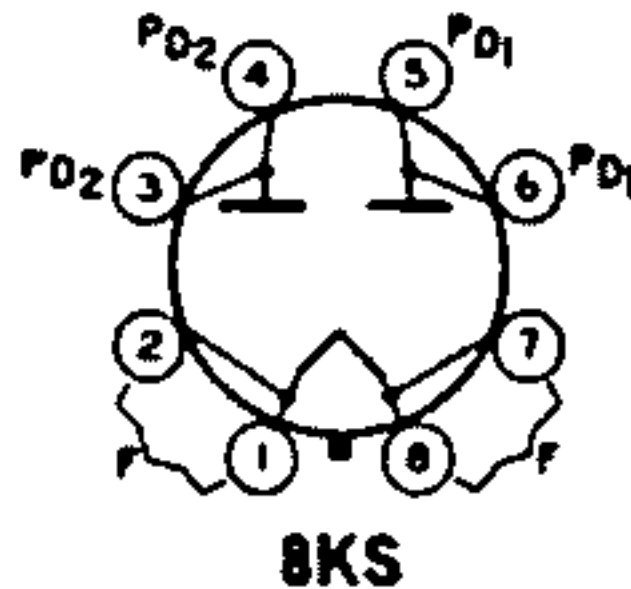


- 5BE8**
- 5BK7A**
- 5BQ7A**
- 5BR8**
- 5BT8**
- 5BW8**
- 5CG8**
- 5CL8**

- Refer to chart at end of section.
- Refer to type 6BK7B.
- Refer to type 6BQ7A.
- Refer to type 6BR8A.
- Refer to chart at end of section.
- Refer to type 6BW8.
- Refer to type 6CG8A.
- Refer to chart at end of section.

Refer to type 6CL8A.  
 Refer to chart at end of section.  
 Refer to type 6CQ8.  
 Refer to type 6CZ5.  
 Refer to chart at end of section.

**5CL8A**  
**5CM8**  
**5CQ8**  
**5CZ5**  
**5DH8**



**FULL-WAVE  
 VACUUM RECTIFIER**

**5DJ4**

Glass octal type used in power supplies of radio and television receivers having high dc requirements. Outlines section, 19E; requires octal socket. Operation in vertical position is preferred, but horizontal operation is permissible if pins 2 and 4 are in vertical plane. It is especially important that this tube, like other power-handling tubes, be adequately ventilated. Filament: volts (ac/dc), 5; amperes, 3.

**Full-Wave Rectifier**

**MAXIMUM RATINGS (Design-Maximum Values)**

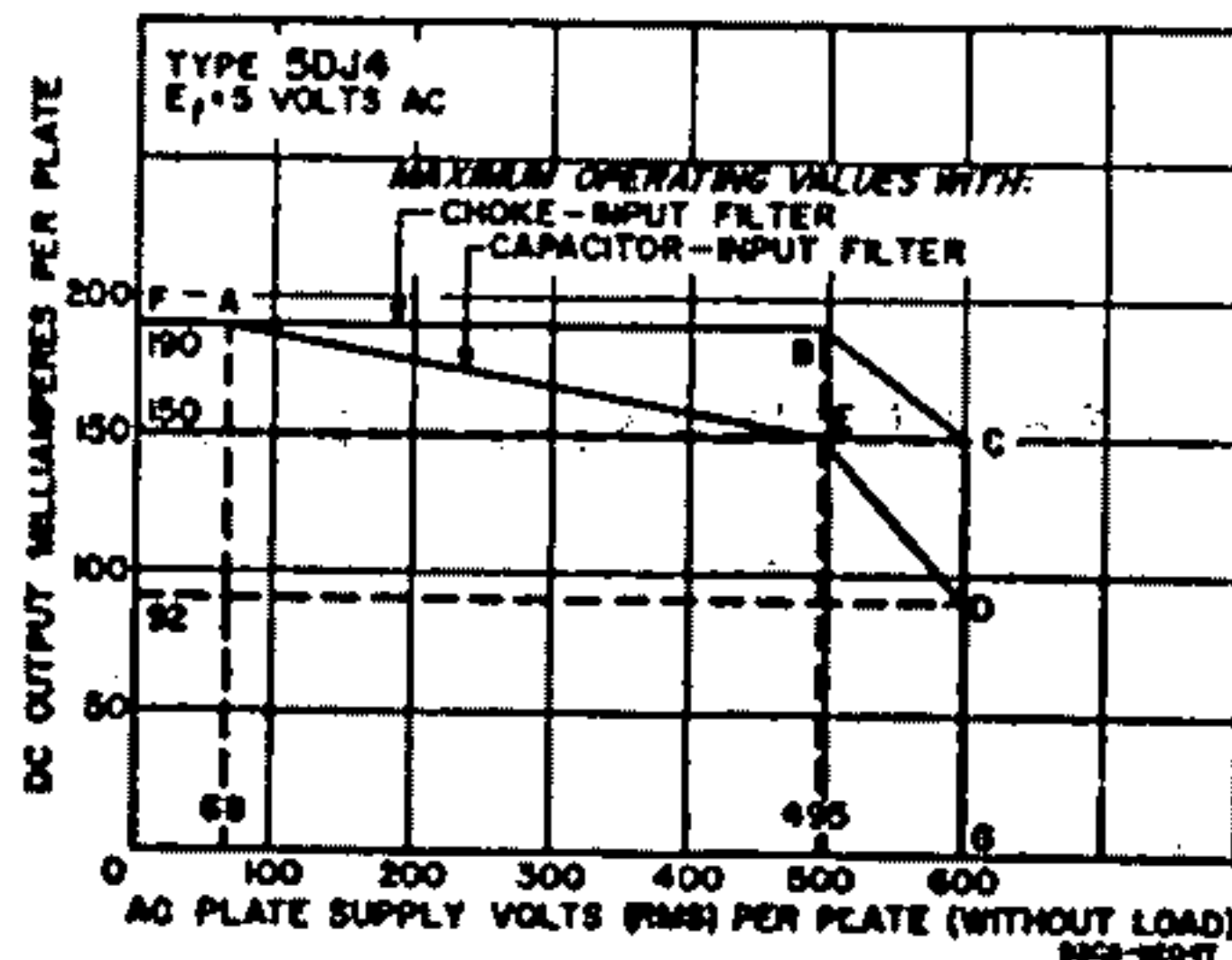
Peak Inverse Plate Voltage .....	1700	volts
Peak Plate Current (Per Plate) .....	1	ampere
Hot-Switching Transient Plate Current (Per Plate) .....	5	amperes
AC Plate-Supply Voltage (Per Plate, rms, without load) .....	See Rating Chart	
Average Output Current (Per Plate) .....	See Rating Chart	

**TYPICAL OPERATION**

	Filter Input			
	Capacitor	Choke		
AC Plate-to-Plate Supply Voltage (rms, without load)	600	900	1100	volts
Filter-Input Capacitor <sup>a</sup> .....	40	40	—	μF
Filter-Input Choke .....	—	—	10	henries
Effective Plate-Supply Impedance per Plate .....	21	67	—	ohms
DC Output Voltage at Input to Filter (Approx.) ..	290	460	420	volts
Average Output Current .....	300	275	275	mA

<sup>a</sup> When capacitor values greater than 40 μF are used, the effective plate-supply impedance should be increased so that the maximum rating for peak plate current is not exceeded.

**RATING CHART**



Refer to type 6EA8.  
 Refer to type 6EU8.  
 Refer to type 6EW6.  
 Refer to type 6FG7.  
 Refer to type 6FV8A.  
 Refer to type 6GH8A.  
 Refer to type 6GM6.

**5EA8**  
**5EU8**  
**5EW6**  
**5FG7**  
**5FV8**  
**5GH8**  
**5GH8A**  
**5GM6**



**5GX6**

Refer to type 6GX6.

**5GX7**

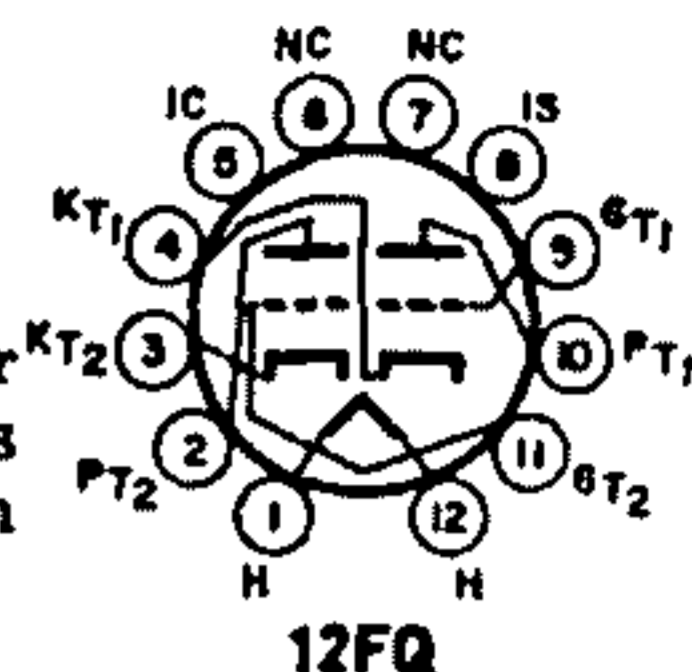
Refer to type 6GX7.

**5HA7**

**DUAL TRIODE**

4HA7

Duodecar type used as a sync clipper and age amplifier in television receivers. Outlines section, 8A; requires duodecar 12-contact socket. Type 4HA7 is identical with type 5HA7 except for the heater ratings.



	4HA7	5HA7	
Heater Voltage (ac/dc)	4.2	5.6	volts
Heater Current	0.6	0.45	ampere
Heater Warm-up Time (Average)	11	11	seconds
Heater-Cathode Voltage:			
Peak value	±200 max	±200 max	volts
Average value	100 max	100 max	volts

**Class A<sub>1</sub> Amplifier**

MAXIMUM RATINGS (Design-Maximum Values)	Unit No.1	Unit No.2	
Plate Voltage	330	330	volts
Grid Voltage:			
Positive-bias value	0	0	volts
Negative-bias value	-50	-50	volts
Cathode Current	20	—	mA
Plate Dissipation	2.75	0.3	watts
<b>CHARACTERISTICS</b>			
Plate Voltage	250	250	volts
Grid Voltage	-8.5	-2.0	volts
Amplification Factor	17	100	
Plate Resistance (Approx.)	7700	62500	ohms
Transconductance	2200	1600	μmhos
Plate Current	10.5	1.2	mA
Grid Voltage (Approx.) for plate current of 10 μA	-24	—	volts

**5HB7**

Refer to type 6HB7.

**5HG8**

Refer to type 6HG8.

**5HZ6**

Refer to type 6HZ6.

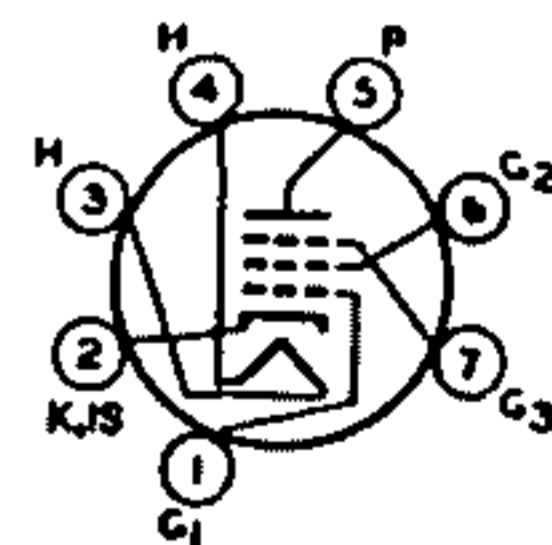
**5J6**

Refer to type 6J6A.

**5JK6**

**SHARP-CUTOFF PENTODE**

Miniature type used for if-amplifier applications in color and black-and-white television receivers. Outlines section, 5C; requires miniature 7-contact socket.



7CM

Heater Voltage (ac/dc)	4.9	volts
Heater Current	0.45	ampere
Heater Warm-up Time (Average)	11	seconds
Heater-Cathode Voltage:		
Peak value	±200 max	volts
Average value	100 max	volts
Direct Interelectrode Capacitances:		
Grid No.1 to Plate	0.02 max	pF
Grid No.1 to Cathode, Heater, Grid No.2, Grid No.3, and Internal Shield	0.5	pF
Plate to Cathode, Heater, Grid No.2, Grid No.3, and Internal Shield	2.7	pF

**Class A<sub>1</sub> Amplifier**

MAXIMUM RATINGS (Design-Maximum Values)		
Plate Voltage	275	volts

Grid-No.2 (Screen-Grid) Supply Voltage .....	275	volts
Grid-No.2 Voltage .....	See curve page 96	
Cathode Current .....	22	mA
Plate Dissipation .....	2.5	watts
Grid-No.2 Input:		
For grid-No.2 voltages up to 187.5 volts .....	0.6	watt
For grid-No.2 voltages between 187.5 and 275 volts .....	See curve page 96	

**CHARACTERISTICS**

Plate Voltage .....	125	volts
Grid No.3 .....	Connected to cathode at socket	
Grid-No.2 Voltage .....	125	volts
Cathode-Bias Resistor .....	68	ohms
Plate Resistance (Approx.) .....	18000	$\mu$ mhos
Transconductance .....	0.15	megohm
Plate Current .....	11.5	mA
Grid-No.2 Current .....	3.9	mA
Grid-No.1 Voltage (Approx.) for plate current of 20 $\mu$ A .....	-3.5	volts
Input Resistance at 44 MHz .....	4000	ohms

**MAXIMUM CIRCUIT VALUE**

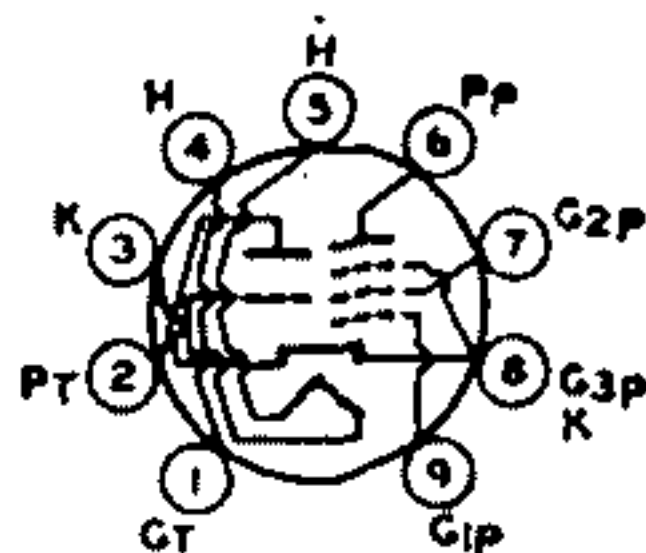
Grid-No.1 Circuit Resistance, for cathode-bias operation .....	0.5	megohm
--	-----	--------

Refer to type 6KD8.

**5KD8**

Refer to type 6KE8.

**5KE8**



**9GF**

**MEDIUM-MU TRIODE—  
SHARP-CUTOFF PENTODE**

**5LJ8**

4LJ8

Miniature type used as combined vhf oscillator and mixer in television receivers. Outlines section, 6B; requires miniature 9-contact socket. Type 4LJ8 is identical with type 5LJ8 except for heater ratings.

	<b>4LJ8</b>	<b>5LJ8</b>	
Heater Voltage (ac/dc) .....	4.3	5.6	volts
Heater Current .....	0.6	0.45	ampere
Heater Warm-up Time (Average) .....	11	11	seconds
Heater-Cathode Voltage:			
Peak value .....	$\pm 200$ max	$\pm 200$ max	volts
Average value .....	100 max	100 max	volts

**Class A<sub>1</sub> Amplifier**

**MAXIMUM RATINGS (Design-Maximum Values)**

	Triode Unit	Pentode Unit	
Plate Voltage .....	280	250	volts
Grid-No.2 (Screen-Grid) Supply Voltage .....	—	280	volts
Grid-No.2 Voltage .....	—	See curve page 96	
Grid-No.1 (Control-Grid) Voltage, Positive-bias value .....	0	0	volts
Plate Dissipation .....	2	2	watts
Grid-No.2 Input .....	—	0.5	watt
Cathode Current .....	20	20	mA

**CHARACTERISTICS**

Plate Supply Voltage .....	125	125	volts
Grid-No.2 Supply Voltage .....	—	125	volts
Grid No.1 .....	Connected to negative end of cathode-bias resistor		
Cathode-Bias Resistor .....	68	88	ohms
Amplification Factor .....	40	—	
Plate Resistance (Approx.) .....	5000	125000	ohms
Transconductance .....	8000	18000	$\mu$ mhos
Plate Current .....	13	12	mA
Grid-No.2 Current .....	—	3.5	mA
Grid-No.1 Voltage (Approx.) for plate current of 30 $\mu$ A .....	-6.5	-4	volts

**MAXIMUM CIRCUIT VALUES**

Grid-No.1-Circuit Resistance:			
For fixed-bias operation .....	1.0	0.5	megohm
For cathode-bias operation .....	0.5	0.25	megohm

Refer to chart at end of section.

**5T4**

Refer to type 6T8A.

**5T8**

Refer to chart at end of section.

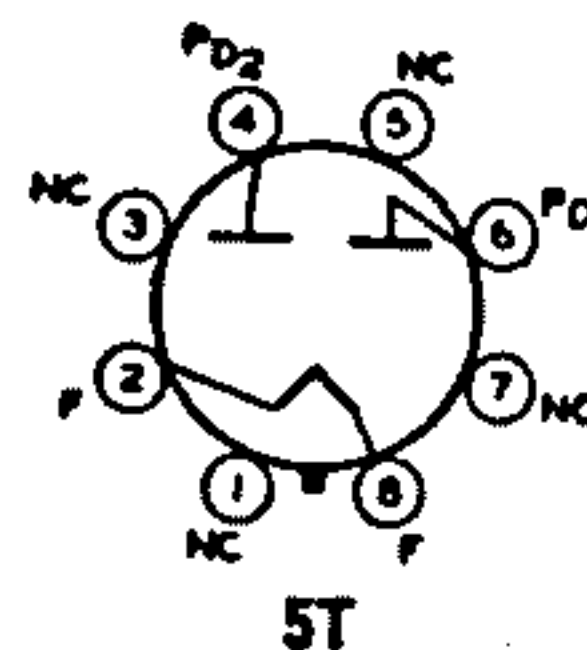
**5U4G**



## FULL-WAVE VACUUM RECTIFIER

# 5U4GB

Glass octal type used in power supplies of radio and color and black-and-white television receivers having high dc requirements. Outlines section, 19E; requires octal socket. This type may be supplied with pins 3, 5, and 7 omitted. Vertical mounting is preferred, but horizontal mounting is permissible if pins 1 and 4 are in vertical plane. The coated filament is designed to operate from the ac line through a step-down transformer. The voltage at the filament terminals should be 5 volts at an average line voltage of 117 volts. It is especially important that this tube, like other power-handling tubes, be adequately ventilated. For discussion of Rating Chart and Operation Characteristics, refer to Interpretation of Tube Data. Filament: volts (ac), 5; amperes, 3.

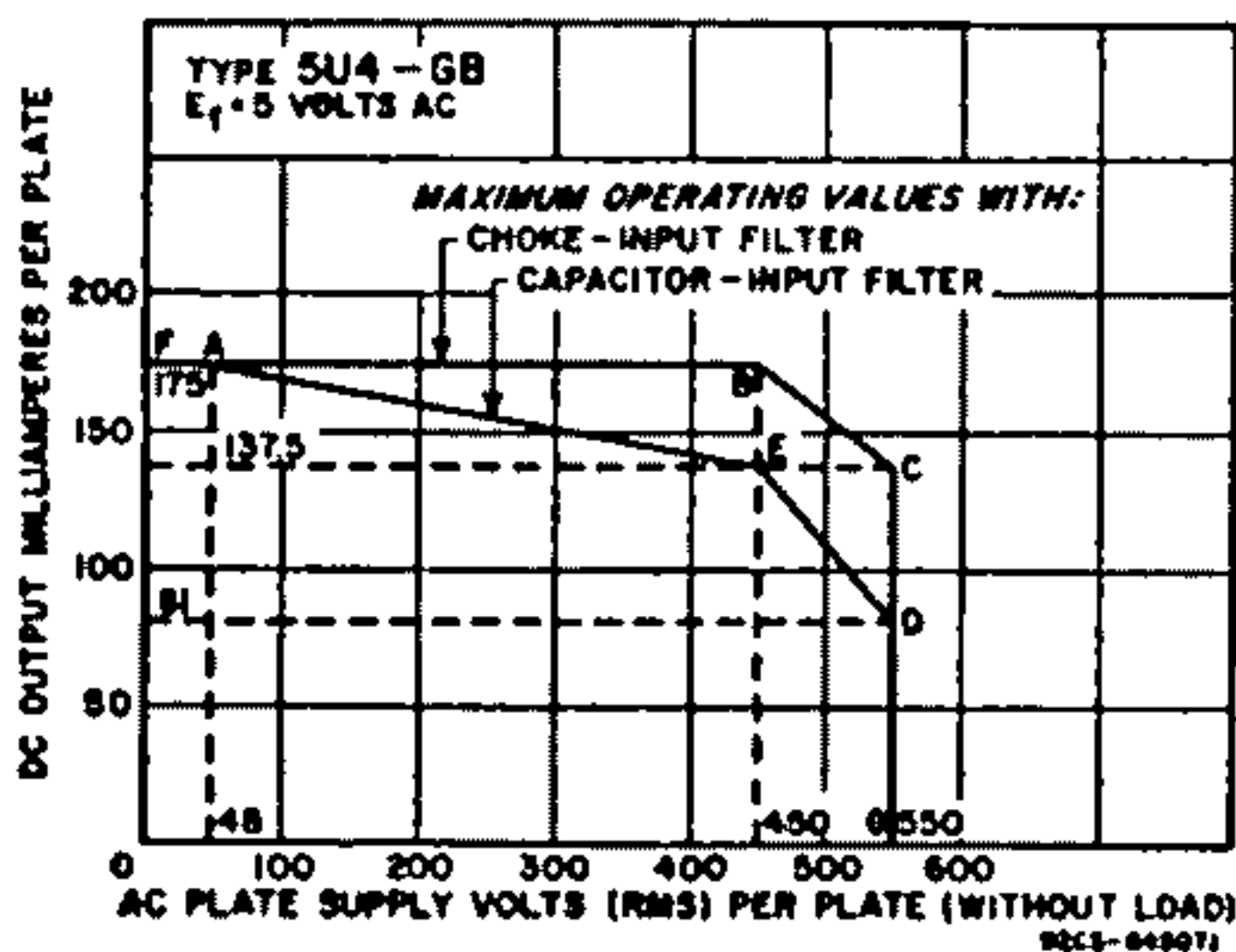


### Full-Wave Rectifier

#### MAXIMUM RATINGS (Design-Maximum Values)

Peak Inverse Plate Voltage .....	1650	volts
Peak Plate Current (Per Plate) .....	1.0	ampere
Hot-Switching Transient Plate Current (Per Plate) .....	#	
AC Plate Supply Voltage (Per Plate, rms) .....	See Rating Chart	
Average Output Current (Per Plate) .....	See Rating Chart	

RATING CHART



#### TYPICAL OPERATION WITH CAPACITOR INPUT TO FILTER

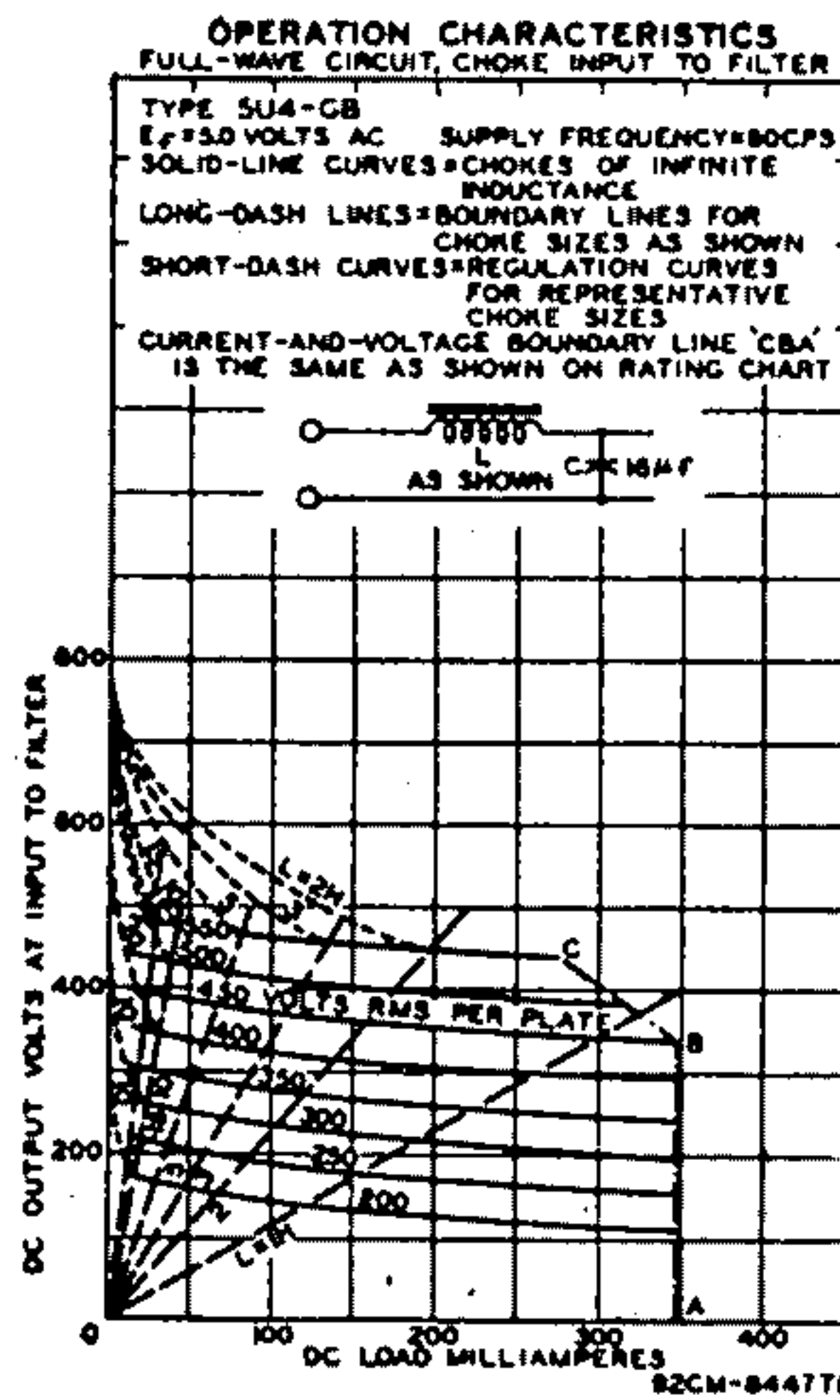
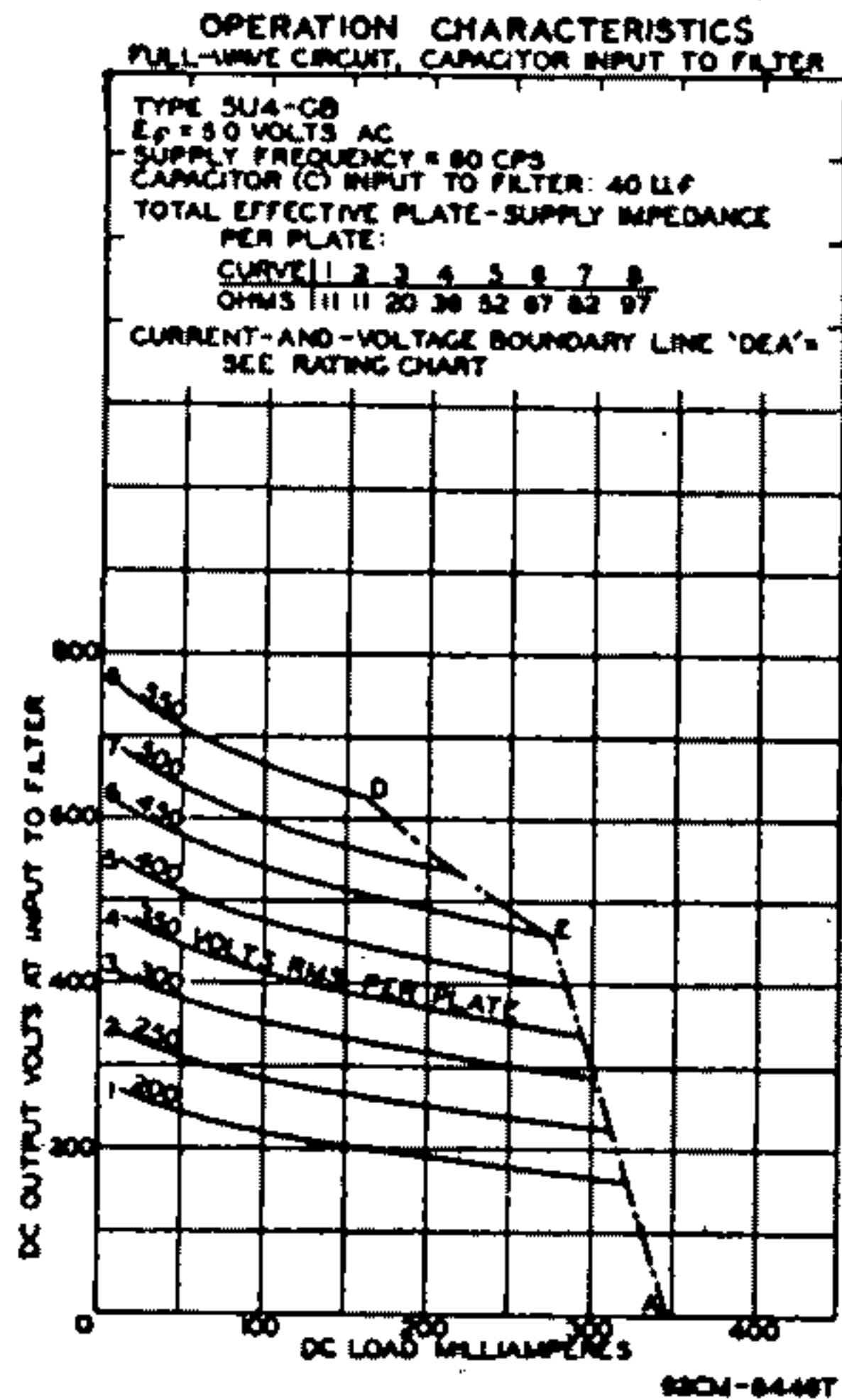
AC Plate-to-Plate Supply Voltage (rms) .....	600	900	1100	volts
Filter-Input Capacitor* .....	40	40	40	$\mu$ F
Total Effective Plate-Supply Impedance per Plate .....	21	67	97	ohms
DC Output Voltage at Input to Filter (Approx.):				
At half-load current of	{			
150 mA .....	335	—	—	volts
137.5 mA .....	—	520	—	volts
81 mA .....	—	—	680	volts
At full-load current of	{			
300 mA .....	290	—	—	volts
275 mA .....	—	460	—	volts
162 mA .....	—	—	630	volts
Voltage Regulation (Approx.):				
Half-load to full-load current .....	45	60	50	volts

#### TYPICAL OPERATION WITH CHOKE INPUT TO FILTER

AC Plate-to-Plate Supply Voltage (rms) .....	900	1100	volts	
Filter-Input Choke .....	10	10	henries	
DC Output Voltage at Input to Filter (Approx.):				
At half-load current of	{			
174 mA .....	355	—	volts	
137.5 mA .....	—	455	volts	
At full-load current of	{			
348 mA .....	340	—	volts	
275 mA .....	—	440	volts	
Voltage Regulation (Approx.):				
Half-load to full-load current .....	15	15	volts	

\* If hot switching is regularly required in operation, the use of choke-input circuits is recommended. Such circuits limit the hot-switching current to a value no higher than that of the peak plate current. When capacitor-input circuits are used, a maximum peak current value per plate of 4.6 amperes during the initial cycles of the hot-switching transient should not be exceeded.

\* Higher values of capacitance than indicated may be used, but the effective plate-supply impedance may have to be increased to prevent exceeding the maximum rating for peak plate current.



Refer to type 6U8A.

Refer to types 6U9 and 6U9/ECF 200.

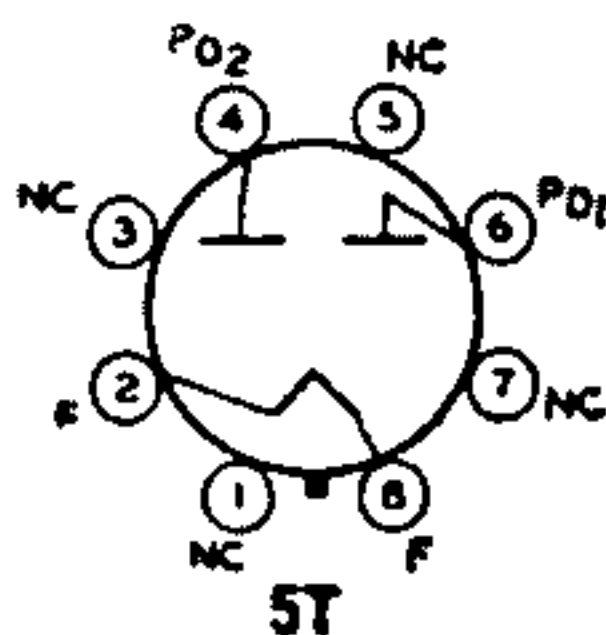
Refer to chart at end of section.

5U8

5U9  
5U9/LCF201

5V3

5V3A



**FULL-WAVE VACUUM RECTIFIER**

Glass octal type used in power supplies of color and black-and-white television receivers and other equipment having high dc requirements. Outlines section, 19E; requires octal socket. Vertical mounting is preferred, but horizontal mounting is permissible if pins 2 and 4 are in vertical plane. It is especially important that this tube, like other power-handling tubes, be adequately ventilated. For discussion of Rating Chart, refer to Interpretation of Tube Data. Filament: volts (ac/dc), 5; amperes, 3.

**Full-Wave Rectifier**

**MAXIMUM RATINGS (Design-Maximum Values)**

Peak Inverse Plate Voltage .....	1550	volts
Peak Plate Current (Per Plate) .....	1.4	amperes
Hot-Switching Transient Plate Current (Per Plate) .....	6.6	amperes



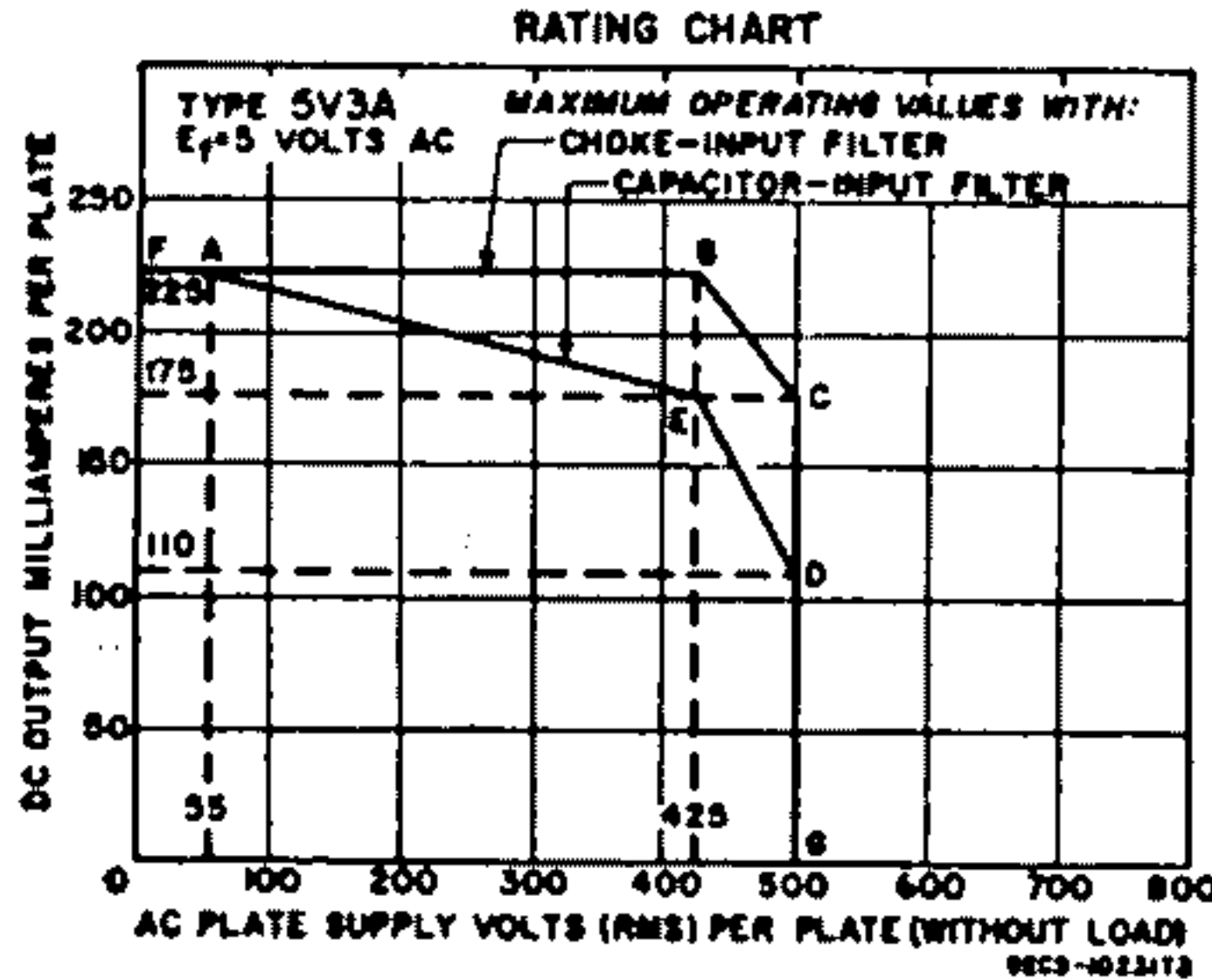
AC Plate-Supply Voltage (Per Plate, rms, without load) .....	550	volts
Average Output Current (Per Plate) .....	415*	mA
* With capacitor-input filter for ac plate-supply volts (rms, per plate, without load) = 470.		

**TYPICAL OPERATION**

Filter Input	Capacitor	Choke	
AC Plate-to-Plate Supply Voltage (rms) .....	850	1000	volts
Filter-Input Capacitor* .....	40	—	$\mu$ F
Effective Plate-Supply Impedance per Plate .....	50	—	ohms
Minimum Filter-Input Choke .....	—	10	henries
Average Output Current .....	350	350	mA
DC Output at Input to Filter (Approx.) .....	440	390	volts

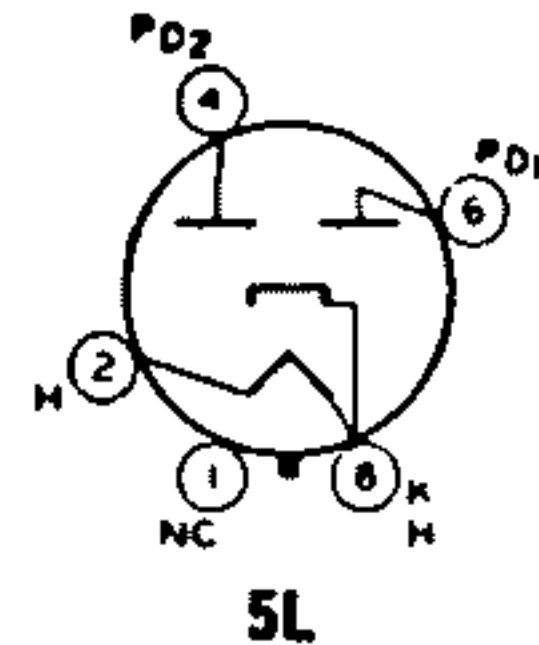
**CHARACTERISTICS**

Tube Voltage Drop for plate current of 350 mA (per plate) .... 42 volts  
 \* When capacitor values greater than 40  $\mu$ F are used, the effective plate-supply impedance should be increased so that the maximum rating for peak plate current is not exceeded.



**5V4G  
5V4GA**

**FULL-WAVE  
VACUUM RECTIFIER**



Glass octal types used in full-wave power supplies having high dc requirements. Outlines section, 25 and 19B, respectively; require octal socket. The heater is designed to operate from the ac line through a step-down transformer. The voltage at the heater terminals should be 5 volts under operating conditions at an average line voltage of 117 volts. It is especially important that these tubes, like other power-handling tubes, be adequately ventilated. Heater: volts (ac/dc), 5; amperes, 2.

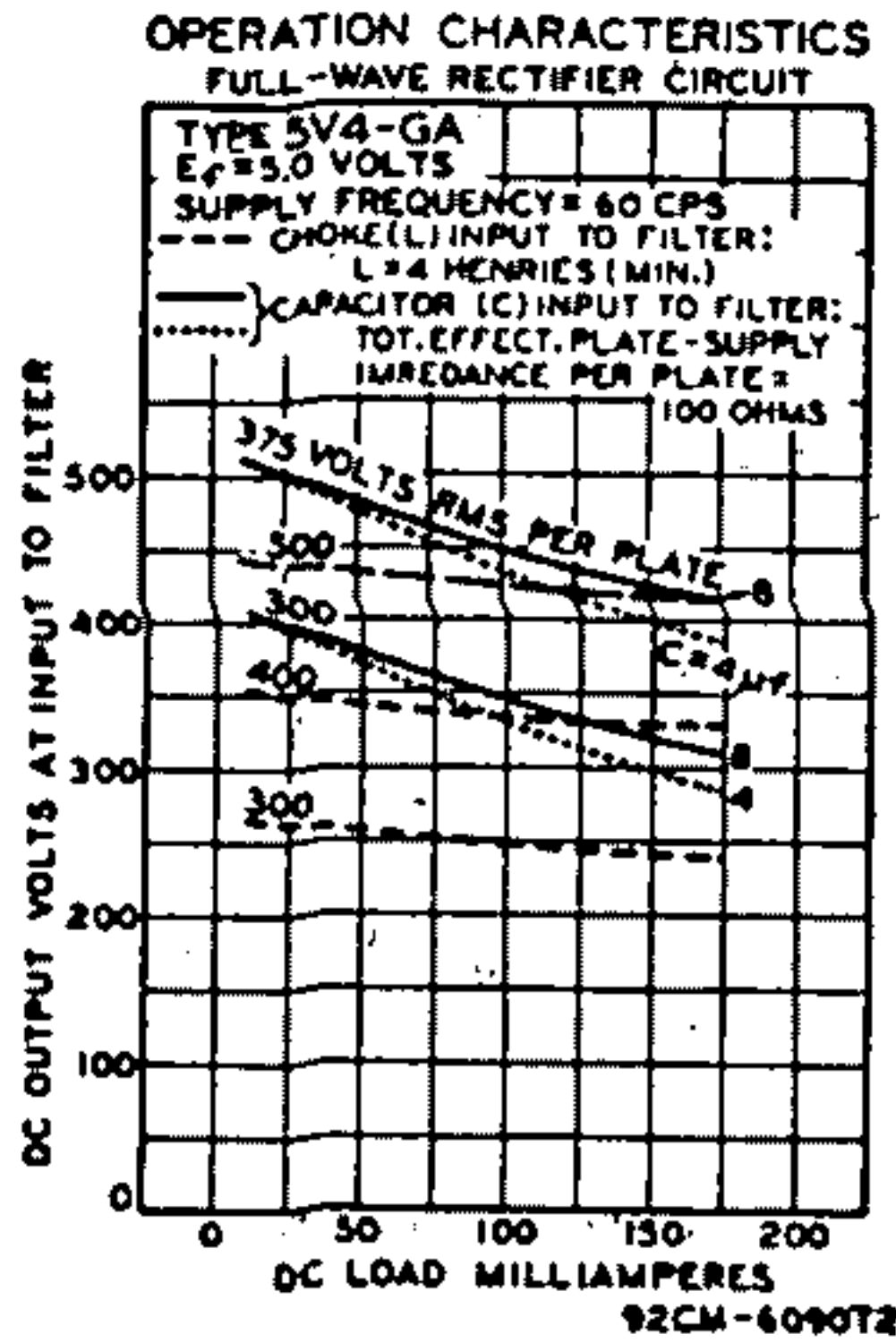
**Full-Wave Rectifier**

<b>MAXIMUM RATINGS (Design-Center Values)</b>		
Peak Inverse Plate Voltage .....	1400	volts
AC Plate-Supply Voltage (Per Plate, rms):		
With capacitor-input filter .....	375	volts
With choke-input filter .....	500	volts
Peak Plate Current (Per Plate) .....	525	mA
Average Output Current .....	175	mA

**TYPICAL OPERATION**

Filter Input	Capacitor	Choke	
AC Plate-to-Plate Supply Voltage (rms) .....	750	1000	volts
Filter-Input Capacitor* .....	10	—	$\mu$ F
Total Effective Plate-Supply Impedance per Plate ..	100	—	ohms
Filter-Input Choke .....	—	4	henries
DC Output Voltage at Input to Filter (Approx.):			
At output current of 175 mA .....	410	410	volts

\* Higher values of capacitance than indicated may be used, but the effective plate-supply impedance may have to be increased to prevent exceeding the maximum rating for peak plate current.



Refer to type 6V6.

Refer to chart at end of section.

Refer to chart at end of section.

Refer to type 6X8.

Refer to chart at end of section.

**5V6GT**

**5W4  
5W4GT**

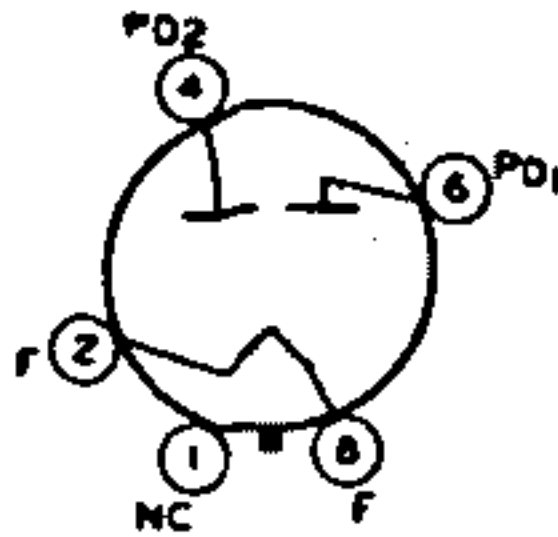
**5X4G**

**5X8**

**5Y3G**

**FULL-WAVE  
VACUUM RECTIFIER**

**5Y3GT**



**5Y3GT**

of Rating Chart and Operating Characteristics, refer to Interpretation of Tube Data. Filament: volts (ac), 5; amperes, 2.

Glass octal type used in power supplies of radio and television equipment having moderate dc requirements. Outlines section, 13E; requires octal socket. Vertical mounting is preferred, but horizontal mounting is permissible if pins 2 and 8 are in horizontal plane. It is especially important that this tube, like other power-handling tubes, be adequately ventilated. For discussion

**Full-Wave Rectifier**

**MAXIMUM RATINGS (Design-Center Values)**

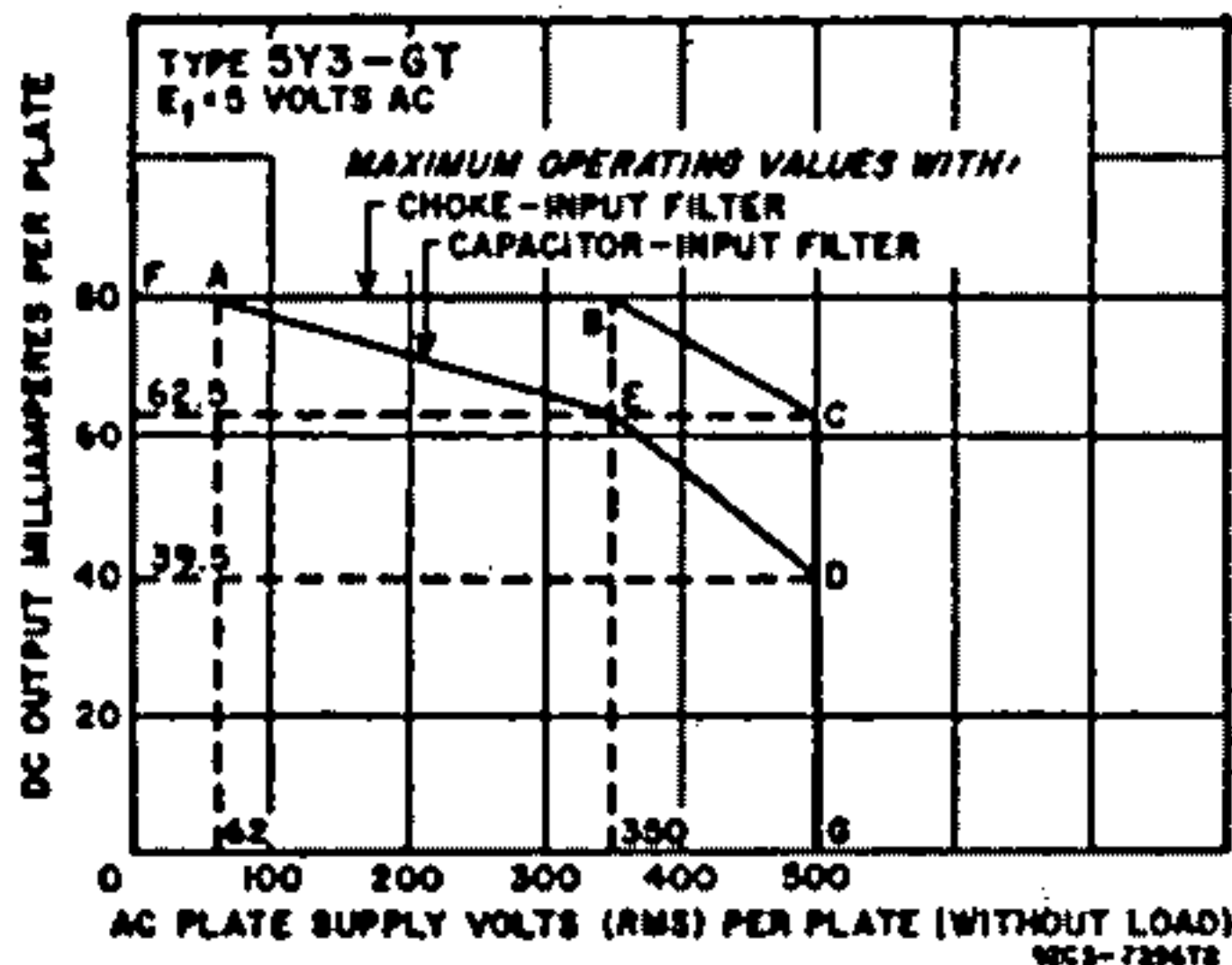
Peak Inverse Plate Voltage .....	1400	volts
Peak Plate Current (Per Plate) .....	440	mA
Hot-Switching Transient Plate Current (Per Plate) .....	2.5	amperes
AC Plate Supply Voltage (Per Plate, rms) .....	See Rating Chart	
DC Output Current (Per Plate) .....	See Rating Chart	

**TYPICAL OPERATION WITH CAPACITOR INPUT TO FILTER**

AC Plate-to-Plate Supply Voltage (rms) .....	700	1000	volts
Filter Input Capacitor* .....	20	10	$\mu$ F
Effective Plate-Supply Impedance per Plate .....	50	140	ohms
DC Output Voltage at Input to Filter (Approx.): ..			
At half-load current of { 62.5 mA .....	390	—	volts
42 mA .....	—	610	volts
At full-load current of { 125 mA .....	360	—	volts
84 mA .....	—	560	volts
Voltage Regulation (Approx.):			
Half-load to full-load current .....	40	50	volts



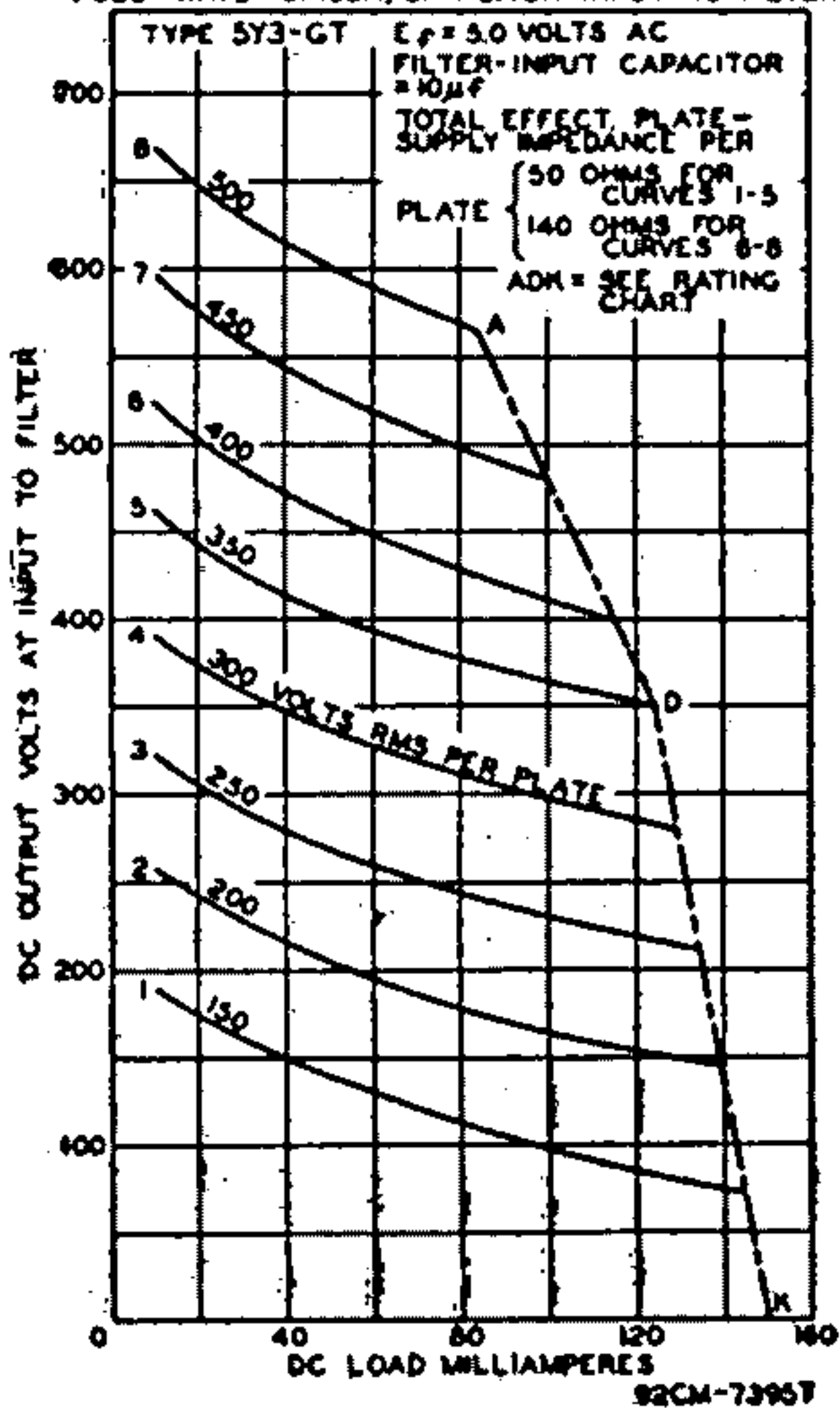
RATING CHART



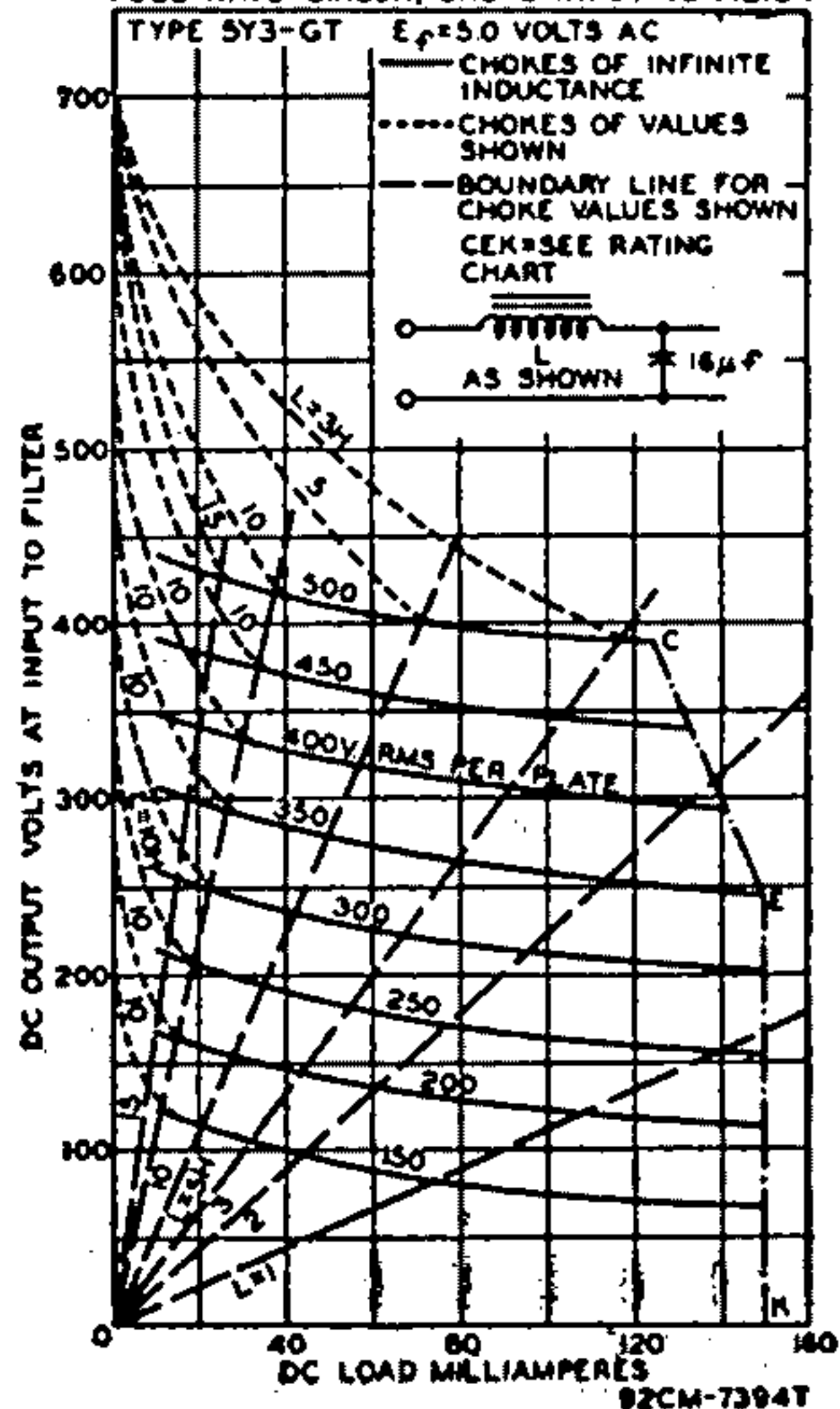
TYPICAL OPERATION WITH CHOKE INPUT TO FILTER

AC Plate-to-Plate Supply Voltage (rms)	700	1000	volts
Filter Input Choke#	10	10	henries
DC Output Voltage at Input to Filter (Approx.):			
At half-load current of	75 mA	—	volts
	62.5 mA	405	volts
At full-load current of	150 mA	—	volts
	125 mA	380	volts
Voltage Regulation (Approx.):			
Half-load to full-load current	25	15	volts

OPERATION CHARACTERISTICS  
FULL-WAVE CIRCUIT, CAPACITOR INPUT TO FILTER



OPERATION CHARACTERISTICS  
FULL-WAVE CIRCUIT, CHOKE INPUT TO FILTER



\* Higher values of capacitance than indicated may be used but the effective plate supply impedance may have to be increased to prevent exceeding the maximum rating for hot-switching transient plate current.

† This value is adequate to maintain optimum regulation in the region to the right of line L = 10H on curve OPERATION CHARACTERISTICS with Choke Input to Filter, provided the load currents are not less than 35 mA and 50 mA, respectively, for plate-to-plate supply voltages of 700 and 1000 volts (rms).

Refer to chart at end of section.

**5Y4G**

Refer to chart at end of section.

**5Y4GA**

**5Y4GT**

Refer to chart at end of section.

**5Z3**

Refer to chart at end of section.

**5Z4**

Refer to chart at end of section.

**6A3**

Refer to chart at end of section.

**6A6**

Refer to chart at end of section.

**6A7**

Refer to chart at end of section.

**6A7S**

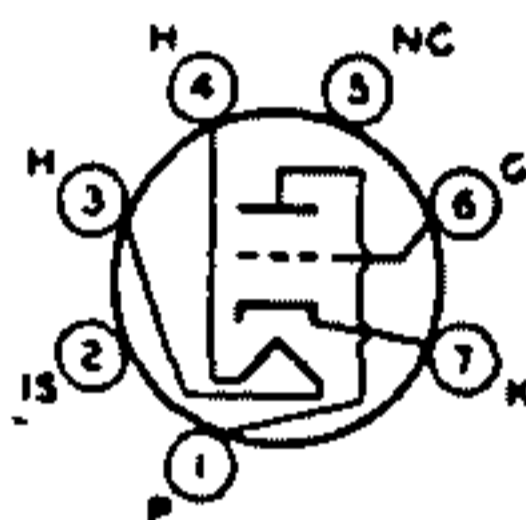
Refer to chart at end of section.

**6A8**

Refer to chart at end of section.

**6A8G**

**6A8GT**



**5CE**

**HIGH-MU TRIODE**

**6AB4**

Miniature type used as cathode-drive amplifier, frequency converter, or oscillator at frequencies up to 300 MHz in television and FM receivers. Outlines section, 5C; requires miniature 7-contact socket. Heater: volts (ac/dc), 6.3; amperes, 0.15. For maximum ratings, characteristics, and curves, refer to type 12AT7.

Refer to chart at end of section.

**6AB5/6N5**

Refer to chart at end of section.

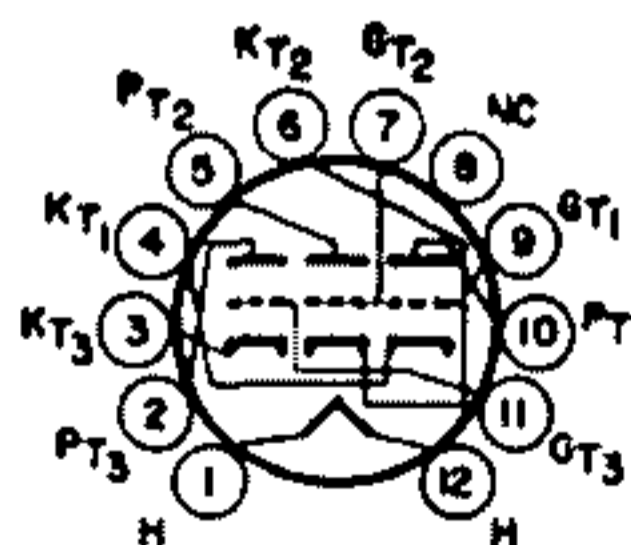
**6AB7**

Refer to chart at end of section.

**6AC5GT**

Refer to chart at end of section.

**6AC7**



**12FE**

**HIGH-MU TRIPLE TRIODE**

**6AC10**

Duodecar type used in matrixing (color-difference) circuits of color television receivers. Outlines section, 8C; requires duodecar 12-contact socket. Heater: volts (ac/dc), 6.3; amperes, 0.6; average warm-up time, 11 seconds; maximum heater-cathode volts, ±200 peak, 100 average.

**Class A<sub>1</sub> Amplifier**

<b>MAXIMUM RATINGS (Design-Maximum Values)</b>		
Plate Voltage .....	330	volts
Plate Dissipation .....	2	watts
<b>CHARACTERISTICS</b>		
Plate Voltage .....	200	volts
Cathode-Bias Resistor .....	150	ohms
Amplification Factor .....	62	
Plate Resistance (Approx.) .....	10700	ohms



Transconductance .....	5800	$\mu$ mhos
Plate Current .....	9	mA
Grid Voltage (approx.) for plate current of 100 $\mu$ A .....	-5	volts
<b>MAXIMUM CIRCUIT VALUE</b>		
Grid-Circuit Resistance .....	0.5	megohm

**6AD6G**

Refer to chart at end of section.

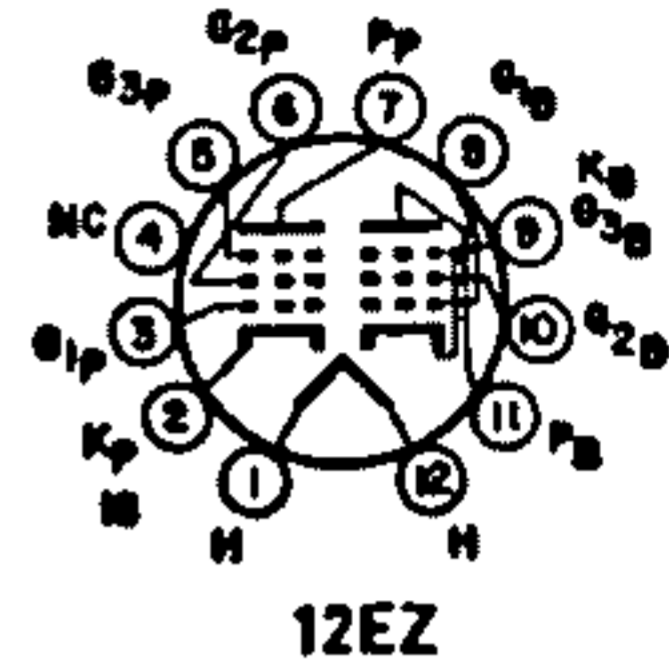
**6AD7G**

Refer to chart at end of section.

## 6AD10

### BEAM POWER TUBE— SHARP-CUTOFF PENTODE

Duodecar type used as FM detector and audio-frequency output amplifier in color and black-and-white television receivers. Outlines section, 8B: requires duodecar 12-contact socket.



Heater Voltage (ac/dc) .....	6.3	volts
Heater Current .....	1.05	amperes
Heater-Cathode Voltage:		
Peak value .....	$\pm 200$ max	volts
Average value .....	100 max	volts
Direct Interelectrode Capacitances:		
Beam Power Unit:		
Grid No.1 to Plate .....	0.26	pF
Grid No.1 to Cathode, Heater, Grid No.2, Grid No.3, and Internal Shield .....	11	pF
Plate to Cathode, Heater, Grid No.2, Grid No.3, and Internal Shield .....	11	pF
Pentode Unit:		
Grid No.1 to Plate .....	0.024	pF
Grid No.3 to Plate .....	3.4	pF
Grid No.1 to Cathode, Heater, Grid No.2, Grid No.3, and Internal Shield .....	8	pF
Grid No.3 to Cathode, Heater, Grid No.1, Grid No.2, Plate, and Internal Shield .....	9.5	pF
Grid No.1 to Grid No.3 .....	0.12	pF
Plate of Beam Power Unit to Plate of Pentode Unit .....	0.34	pF

#### Beam Power Unit as Class A<sub>1</sub> Amplifier

<b>MAXIMUM RATINGS (Design-Maximum Values)</b>		
Plate Voltage .....	275	volts
Grid-No.2 (Screen-Grid) Voltage .....	275	volts
Plate Dissipation .....	10	watts
Grid-No.2 Input .....	2	watts

#### TYPICAL OPERATION

Plate Voltage .....	250	volts
Grid-No.2 Voltage .....	250	volts
Grid-No.1 (Control-Grid) Voltage .....	-8	volts
Peak AF Grid-No.1 Voltage .....	8	volts
Zero-Signal Plate Current .....	35	mA
Maximum-Signal Plate Current .....	39	mA
Zero-Signal Grid-No.2 Current .....	2.5	mA
Maximum-Signal Grid-No.2 Current .....	7	mA
Plate Resistance (Approx.) .....	0.1	megohm
Transconductance .....	6500	$\mu$ mhos
Load Resistance .....	5000	ohms
Total Harmonic Distortion .....	10	per cent

#### MAXIMUM CIRCUIT VALUES

Maximum-Signal Power Output .....	4.2	watts
Grid-No.1-Circuit Resistance:		
For fixed-bias operation .....	0.25	megohm
For cathode-bias operation .....	0.5	megohm

#### Pentode Unit as Class A<sub>1</sub> Amplifier

#### CHARACTERISTICS

Plate Supply Voltage .....	150	volts
Grid No.3 (Control Grid) .....	Connected to negative end of cathode resistor	
Grid-No.2 (Screen-Grid) Voltage .....	100	volts
Grid No.1 (Control Grid) .....	Connected to negative end of cathode resistor	
Cathode-Bias Resistor .....	180	ohms
Plate Resistance (Approx.) .....	0.11	megohm
Transconductance, Grid No.1 to Plate .....	3400	$\mu$ mhos

Transconductance, Grid No.3 to Plate .....	600	ambos
Plate Current .....	3.2	mA
Grid-No.2 Current .....	3.2	mA
Grid-No.1 Voltage (Approx.) for plate current of 20 $\mu$ A .....	-4.5	volts
Grid-No.3 Voltage (Approx.) for plate current of 20 $\mu$ A .....	-7	volts

**Pentode Unit as FM Sound Detector**

**MAXIMUM RATINGS (Design-Maximum Values)**

Plate Voltage .....	300	volts
Grid-No.3 Voltage:		
Negative-bias value .....	-100	volts
Positive-bias value .....	25	volts
Grid-No.2 Supply Voltage .....	300	volts
Grid-No.2 Voltage .....	See curve page 96	
Grid-No.1 Voltage:		
Negative-bias value .....	-50	volts
Positive-bias value .....	0	volts
Plate Dissipation .....	1.7	watts
Grid-No.3 Input .....	0.1	watt
Grid-No.2 Input:		
For grid-No.2 voltages up to 150 volts .....	1	watt
For grid-No.2 voltages between 150 and 300 volts .....	See curve page 96	

**MAXIMUM CIRCUIT VALUES**

Grid-No.3-Circuit Resistance .....	0.68	megohm
Grid-No.1-Circuit Resistance:		
For fixed-bias operation .....	0.22	megohm
For cathode-bias operation .....	0.47	megohm

Refer to chart at end of section.

Refer to chart at end of section.

Refer to chart at end of section.

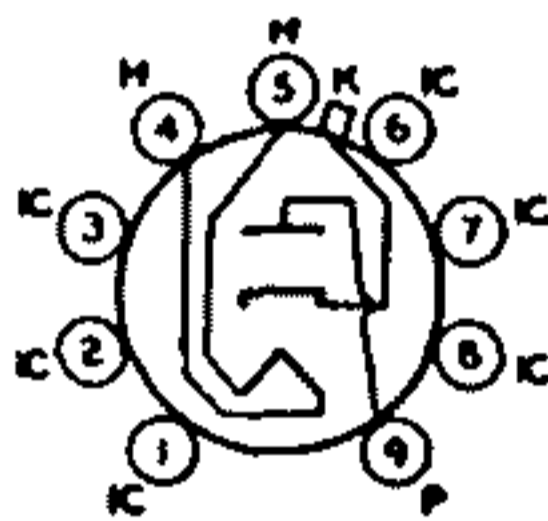
**6AE5GT**

**6AE6G**

**6AE7GT**

**6AF3**

12AF3



9CB

**HALF-WAVE VACUUM RECTIFIER**

Miniature type used as a damper tube in horizontal-deflection circuits of television receivers. Outlines section, 7C; requires miniature 9-contact socket. Socket terminals 1, 2, 3, 6, 7, and 8 should not be used as tie points. It is especially important that this tube, like other power-handling tubes, be adequately ventilated. Type 12AF3 is identical with type 6AF3 except for heater ratings.

Heater Voltage (ac/dc) .....	6AF3	12AF3	
Heater Current .....	6.3	12.6	volts
Heater Warm-up Time (Average) .....	1.2	0.6	amperes
	—	11	seconds

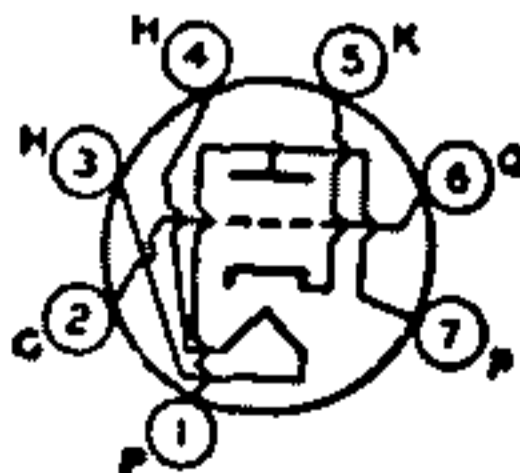
**Damper Service**

For operation in a 525-line, 30-frame system

**MAXIMUM RATINGS (Design-Maximum Values)**

Peak Inverse Plate Voltage $\ddagger$ .....	4500	volts	
Peak Plate Current .....	750	mA	
Average Plate Current .....	185	mA	
Bulb Temperature (At hottest point) .....	210	$^{\circ}$ C	
Heater-Cathode Voltage:			
Peak value .....	+300	-4500	volts
Average value .....	+100	-1000	volts

$\ddagger$  Pulse duration must not exceed 15% of a horizontal scanning cycle (10 microseconds).



7DK

**MEDIUM-MU TRIODE**

Miniature types used as local oscillators in uhf television receivers covering the frequency range of 470 to 890 MHz. Outlines section, 5C and 5B, respectively;

**6AF4**

**6AF4A**

2AF4B, 3AF4A



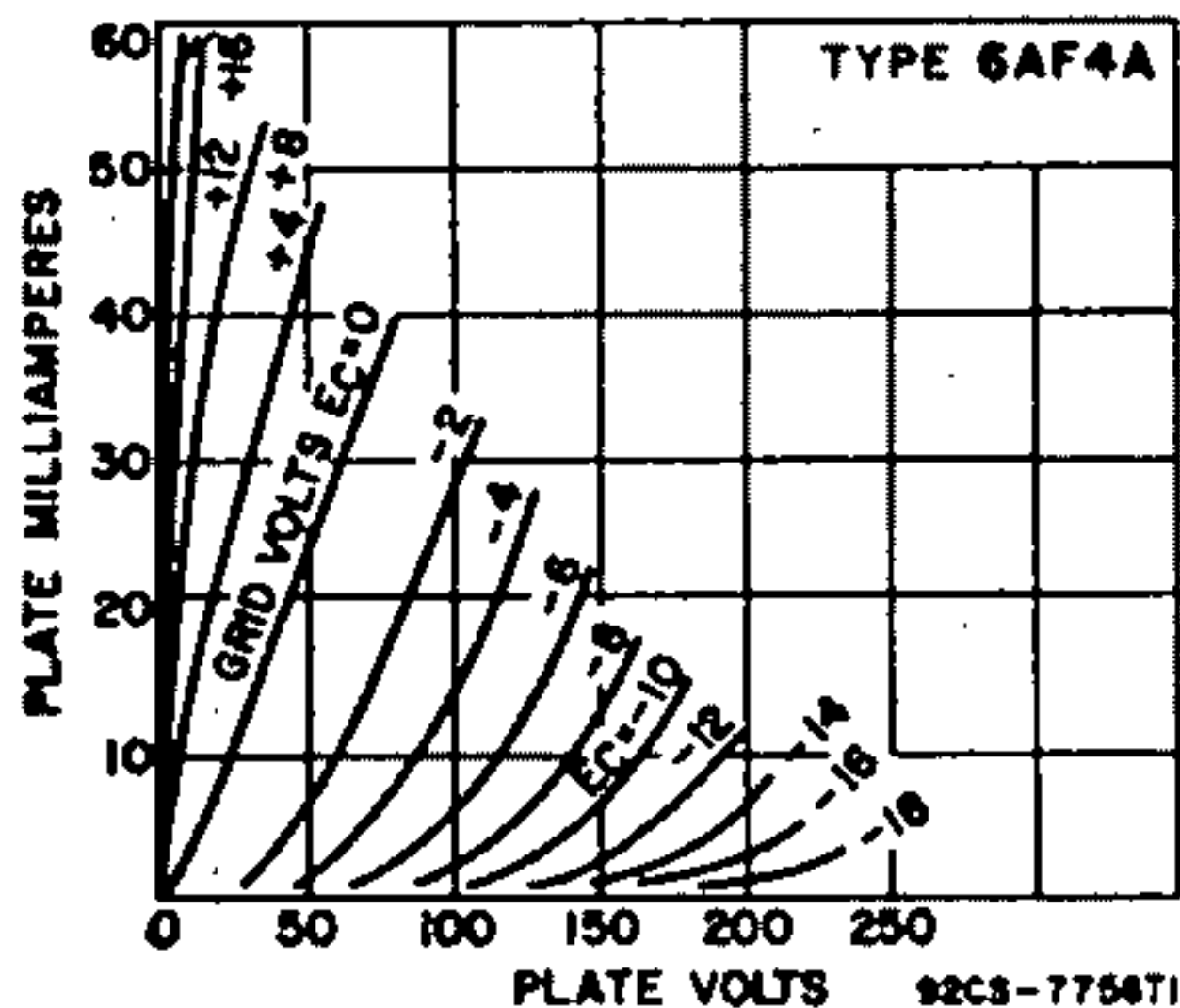
require miniature 7-contact socket. Types 2AF4B and 3AF4A are identical with type 6AF4A except for heater and heater-cathode ratings.

	2AF4B	3AF4A	6AF4 6AF4A	
Heater Voltage (ac/dc) .....	2.85	3.15	6.3	volts
Heater Current .....	0.6	0.45	0.225	ampere
Heater Warm-up Time (Average) .....	11	11	—	seconds
<b>Heater-Cathode Voltage:</b>				
Peak value .....	±180 max	±50 max	±50 max	volts
Average value .....	100 max	25 max	25 max	volts
<b>Direct Interelectrode Capacitances:*</b>				
Grid to Plate .....			1.9	pF
Grid to Cathode and Heater .....			2.2	pF
Plate to Cathode and Heater .....			1.4	pF
Heater to Cathode (External Shield connected to plate) .....			2.2	pF

\* With external shield connected to cathode, except as noted.

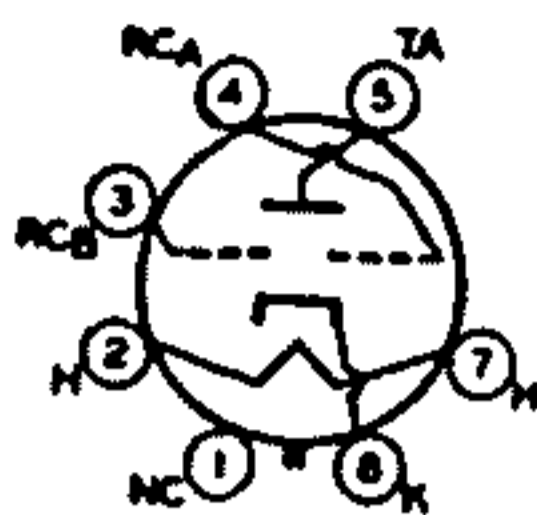
**Class A<sub>1</sub> Amplifier**

<b>CHARACTERISTICS</b>		
Plate Supply Voltage .....	80	volts
Cathode-Bias Resistor .....	150	ohms
Amplification Factor .....	13.5	
Plate Resistance (Approx.) .....	2100	ohms
Transconductance .....	6500	μmhos
Plate Current .....	17.5	mA



**UHF Oscillator**

<b>MAXIMUM RATINGS (Design-Maximum Values)</b>		
Plate Voltage .....	150	volts
Grid Voltage, Negative-bias value .....	-50	volts
Grid Current .....	2	mA
Plate Dissipation .....	2.5	watts
Average Cathode Current .....	24	mA
<b>TYPICAL OPERATION AS OSCILLATOR AT 1000 MHz</b>		
Plate Supply Voltage .....	100	volts
Plate Resistor .....	220	ohms
Grid Resistor .....	10000	ohms
Plate Current .....	17	mA
Grid Current (Approx.) .....	750	μA
<b>MAXIMUM CIRCUIT VALUES</b>		
<b>Grid-Circuit Resistance:</b>		
For fixed-bias operation .....	Not recommended	
For cathode-bias operation .....	0.5	megohm

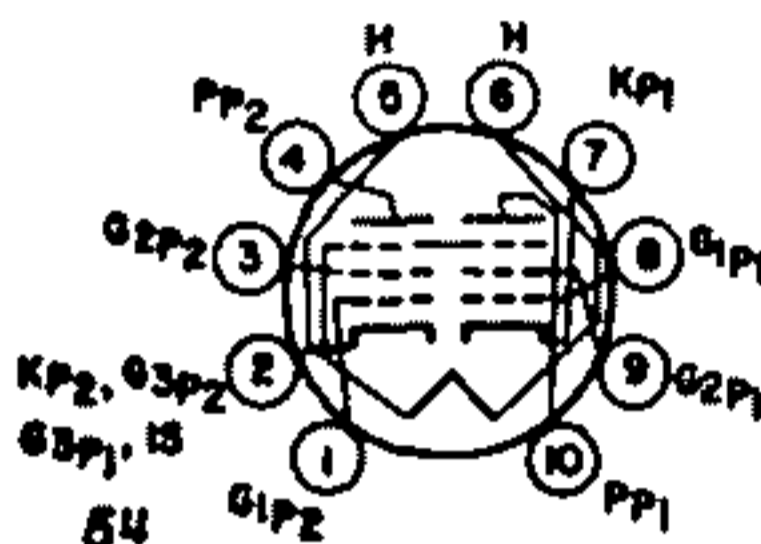


7AG

socket. Heater: volts (ac/dc), 6.3; amperes, 0.15. Maximum ratings in indicator service: fluorescent-target volts, 250 max, 125 min; ray-control-electrode supply volts, 250 max; peak heater-cathode volts, 90 max. Typical operation: fluorescent-target volts, 250; fluorescent-target mA, 3.75; ray-contact-electrode volts (approx. for 0° shadow angle), 155; ray-control-electrode volts (approx. for 100° shadow angle), 0.

**ELECTRON-RAY TUBE**

**6AF6G**



**DUAL PENTODE**

**6AF9**

Miniature type used in television receiver applications. Unit No.1 is used as a video output pentode, and unit No.2 as a sound if amplifier, agc amplifier, or sync separator. Outlines section, 6L, except has 10-pin base; requires miniature 10-contact socket.

Heater Voltage (ac/dc)	6.3	volts	
Heater Current	0.85	ampere	
Peak Heater-Cathode Voltage	±200 max	volts	
Direct Interelectrode Capacitances:			
	Unit No.1	Unit No.2	
Plate to All Other Electrodes (except grid No.1)	7	11	pF
Grid No.1 to All Other Electrodes (except plate)	12	10	pF
Plate to Grid No.1	0.105	0.140	pF
Grid No.1 to Heater	—	0.140	pF
Plate of Unit No.1 to Plate of Unit No. 2	0.150 max		pF
Grid No.1 of Unit No.1 to Grid No.1 of Unit No. 2	0.010 max		pF
Plate of Unit No.1 to Grid No.1 of Unit No.2	0.100 max		pF
Plate of Unit No.2 to Grid No.1 of Unit No.1	0.005 max		pF

**Class A<sub>1</sub> Amplifier**

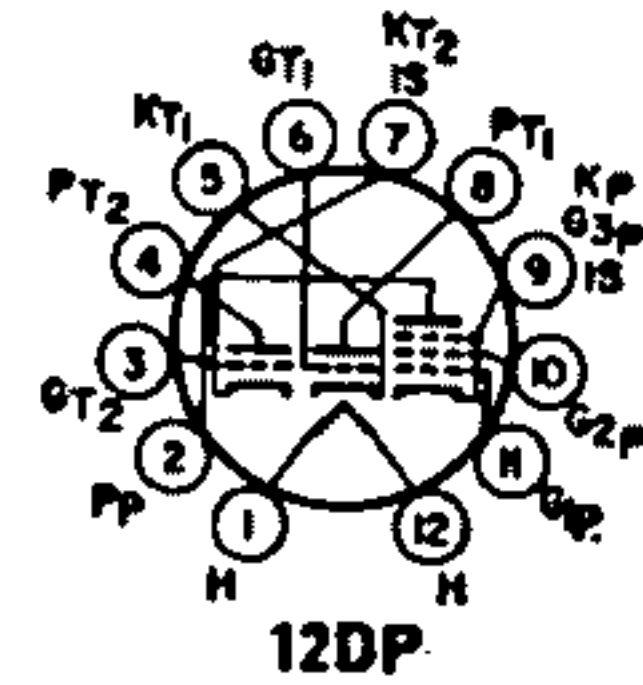
<b>MAXIMUM RATINGS (Design-Maximum Values)</b>	Unit No.1	Unit No.2	
Plate Supply Voltage	550	550	volts
Plate Voltage	250	250	volts
Grid-No.2 (Screen-Grid) Supply Voltage	550	550	volts
Grid-No.2 Voltage	250	250	volts
Cathode Current	60	15	mA
Plate Dissipation	5.1	1.5	watts
Grid-No.2 Input	2.5	0.5	watts
<b>CHARACTERISTICS</b>			
Plate Voltage	170	150	volts
Grid-No.2 Voltage	170	150	volts
Grid-No.1 (Control-Grid) Voltage	-2.6	-2.1	volts
Mu Factor, Grid No.1 to Grid No.2	38	38	
Internal Resistance	0.032	0.16	megohm
Transconductance	22000	8500	μmhos
Plate Current	30	10	mA
Grid-No.2 Current	7.2	3.0	mA
<b>MAXIMUM CIRCUIT VALUE</b>			
Grid-No.1-Circuit Resistance	1	1	megohm

# 6AF11

15AF11

## DUAL TRIODE— SHARP-CUTOFF PENTODE

Duodecar type used in television receiver applications. The high-mu triode unit is used for agc keyer service, the medium-mu triode unit for sync separator service, and the pentode unit for video amplifier service. Outlines section, 8C; requires duodecar 12-contact socket. Type 15AF11 is identical with type 6AF11 except for heater ratings.



	6AF11	15AF11	
Heater Voltage (ac/dc)	6.3	14.7	volts
Heater Current	1.05	0.45	amperes
Heater Warm-up Time (Average)	—	11	seconds
Heater-Cathode Voltage:			
Peak value	±200 max	±200 max	volts
Average value	100 max	100 max	volts

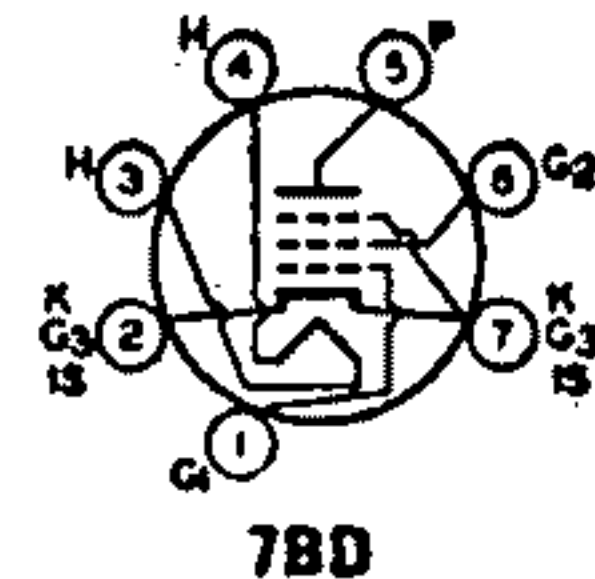
### Class A<sub>1</sub> Amplifier

	Triode Unit No.1	Triode Unit No.2	Pentode Unit	
<b>MAXIMUM RATINGS (Design-Maximum Values)</b>				
Plate Voltage	330	330	330	volts
Grid-No.2 (Screen-Grid) Supply Voltage	—	—	330	volts
Grid-No.2 Voltage	—	—	See curve page 96	
Grid-No.1 (Control-Grid) Voltage, Positive-bias value	0	0	0	volts
Plate Dissipation	1.1	2	5	watts
Grid-No.2 Input:				
For grid-No.2 voltages up to 165 volts	—	—	1.25	watts
For grid-No.2 voltages between 165 and 330 volts	—	—	See curve page 96	
<b>CHARACTERISTICS</b>				
Plate Supply Voltage	200	200	250	volts
Grid-No.2 Supply Voltage	—	—	150	volts
Grid-No.1 Voltage	—2	—	—	volts
Cathode-Bias Resistor	—	220	100	ohms
Amplification Factor	68	41	—	
Plate Resistance (Approx.)	12400	9400	68000	ohms
Transconductance	5500	4400	11000	μmhos
Plate Current	7	9.2	24	mA
Grid-No.2 Current	—	—	4.8	mA
Grid-No.1 Voltage (Approx.) for plate current of 100 μA	—	—6.5	—10	volts
<b>MAXIMUM CIRCUIT VALUES</b>				
Grid-No.1-Circuit Resistance:				
For fixed-bias operation	0.5	0.5	0.25	megohm
For cathode-bias operation	1	1	1	megohm

# 6AG5

## SHARP-CUTOFF PENTODE

Miniature type used in compact radio equipment as an rf or if amplifier up to 400 MHz. Outlines section, 5C; requires miniature 7-contact socket. For typical operation as a resistance-coupled amplifier, refer to Resistance-Coupled Amplifier section.



Heater Voltage (ac/dc)	6.3	volts
Heater Current	0.8	ampere
<b>Direct Interelectrode Capacitances:</b>		
<b>Pentode Unit:</b>		
Grid No.1 to Plate	0.030 max	pF
Grid No.1 to Cathode, Heater, Grid No.2, Grid No.3, and Internal Shield	6.5	pF
Plate to Cathode, Heater, Grid No.2, Grid No.3, and Internal Shield	1.8	pF
<b>Triode Unit:</b>		
Grid No.1 to Plate and Grid No.2	2.6	pF
Grid No.1 to Cathode, Heater, Grid No.3, and Internal Shield	3.6	pF



Grid No.2 to Cathode, Heater, Grid No.3, and Internal Shield . . . . .	3	pF
Plate to Cathode, Heater, Grid No.3, and Internal Shield . . . . .	3	pF

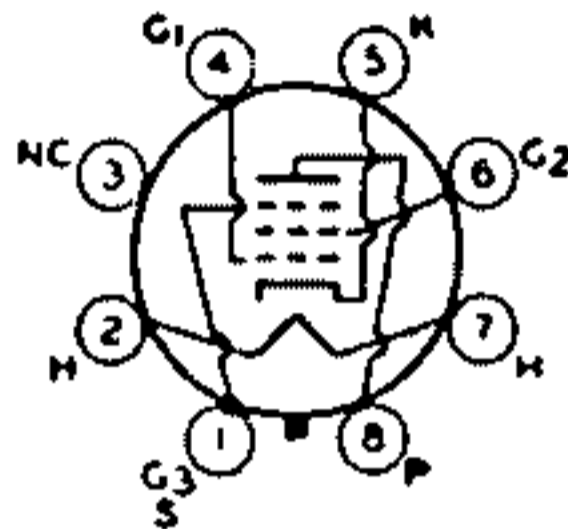
**Class A<sub>1</sub> Amplifier**

MAXIMUM RATINGS (Design-Center Values)	Triode Connection*	Pentode Connection	
Plate Voltage . . . . .	300	300	volts
Grid-No.2 (Screen-Grid) Supply Voltage . . . . .	—	300	volts
Grid-No.2 Voltage . . . . .	—	See curve page 96	
Grid-No.1 (Control-Grid) Voltage, Positive-bias value . . . . .	0	0	volts
Plate Dissipation . . . . .	2.5	2	watts
Grid-No.2 Input:			
For grid-No.2 voltages up to 150 volts . . . . .	—	0.5	watt
For grid No.2 voltages between 150 and 300 volts . . . . .	—	See curve page 96	

**CHARACTERISTICS**

Plate Supply Voltage . . . . .	180	250	100	125	250	volts
Grid-No.2 Supply Voltage . . . . .	—	—	100	125	150	volts
Cathode-Bias Resistor . . . . .	830	820	180	100	180	ohms
Amplification Factor . . . . .	46	42	—	—	—	
Plate Resistance (Approx.) . . . . .	0.008	0.01	0.6	0.5	0.8	megohm
Transconductance . . . . .	5700	3800	4500	5100	5000	μmhos
Plate Current . . . . .	7	5.5	4.5	7.2	6.5	mA
Grid-No.2 Current . . . . .	—	—	1.4	2.1	2.0	mA
Grid-No.1 Voltage (Approx.) for plate current of 10 μA . . . . .	—	—	-5	-6	-8	volts

\* Grid No.2 connected to plate.



8Y

**POWER PENTODE**

**6AG7**

Metal type used in output stage of video amplifier of color and black-and-white television receivers. Outlines section, 2B; requires octal socket.

Heater Voltage (ac/dc) . . . . .	6.8	volts
Heater Current . . . . .	0.65	ampere
Peak Heater-Cathode Voltage . . . . .	±90 max	volts
Direct Interelectrode Capacitances:*		
Grid No.1 to Plate . . . . .	0.06 max	pF
Grid No.1 to Cathode, Heater, Grid No.2, Grid No.3, Shell, and Internal Shield . . . . .	13	pF
Plate to Cathode, Heater, Grid No.2, Grid No.3, Shell, and Internal Shield . . . . .	7.5	pF

\* Pins 1 and 3 connected to Pin No.5.

**Class A<sub>1</sub> Amplifier**

MAXIMUM RATINGS (Design-Center Values)		
Plate Voltage . . . . .	300	volts
Grid-No.2 Voltage . . . . .	300	volts
Grid-No.1 Voltage, Positive-bias value . . . . .	0	volts
Plate Dissipation . . . . .	9	watts
Grid-No.2 Input . . . . .	1.5	watts

**CHARACTERISTICS**

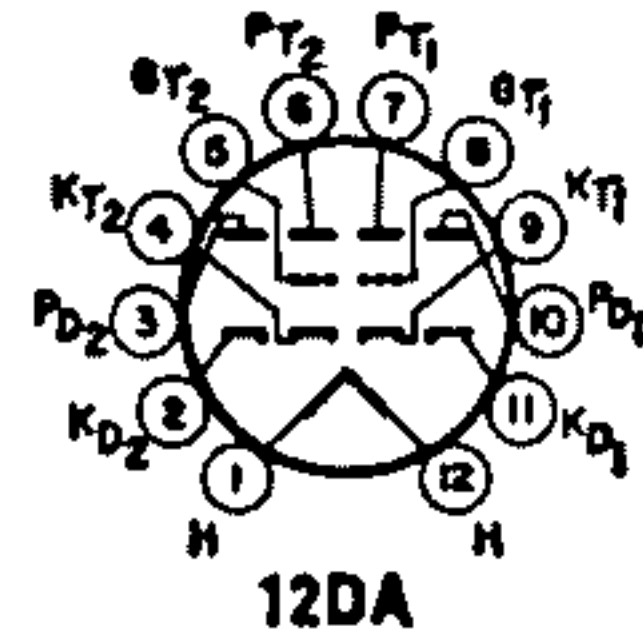
Plate Voltage . . . . .	300	volts
Grid No.3 (Suppressor Grid) . . . . .	Connected to cathode at socket	
Grid-No.2 (Screen-Grid) Voltage . . . . .	150	volts
Grid-No.1 (Control-Grid) Voltage . . . . .	-3	volts
Peak AF Grid-No.1 Voltage . . . . .	3	volts
Zero-Signal Grid-No.2 Current . . . . .	30	mA
Maximum-Signal Grid-No.2 Current . . . . .	30.6	mA
Zero-Signal Grid-No.2 Current . . . . .	7	mA
Maximum-Signal Grid-No.2 Current . . . . .	9	mA
Plate Resistance . . . . .	0.13	megohm
Transconductance . . . . .	11000	μmhos
Load Resistance . . . . .	10000	ohms
Total Harmonic Distortion . . . . .	7	per cent
Maximum-Signal Power Output . . . . .	3	watts

**MAXIMUM CIRCUIT VALUES**

Grid-No.1-Circuit Resistance:		
For fixed-bias operation . . . . .	0.25	megohm
For cathode-bias operation . . . . .	1	megohm

# 6AG11 TWIN DIODE—TWIN TRIODE

Duodecar type containing two diodes and two high-mu triodes, used primarily in FM stereo multiplex service. Outlines section, 8A; requires duodecar 12-contact socket. Heater: volts (ac/dc), 6.3; amperes, 0.75; maximum heater-cathode volts,  $\pm 200$  peak, 100 average



### Class A<sub>1</sub> Amplifier

#### MAXIMUM RATINGS (Design-Maximum Values)

Plate Voltage .....	330	volts
Plate Dissipation .....	2	watts

#### CHARACTERISTICS

Plate Voltage .....	125	volts
Grid Voltage .....	-1	volt
Amplification Factor .....	66	
Plate Resistance (Approx.) .....	8500	ohms
Transconductance .....	7800	$\mu$ mhos
Plate Current .....	7.5	mA
Grid Voltage (Approx.) for plate current of 30 $\mu$ A .....	-5	volts

### Diode Units (Each Unit)

#### MAXIMUM RATINGS (Design-Maximum Values)

Plate Current .....	5	mA
---------------------	---	----

#### CHARACTERISTICS

Tube Voltage Drop for plate current of 18 mA .....	5	volts
--	---	-------

**6AH4GT**

Refer to chart at end of section.

**6AH6**

Refer to chart at end of section.

# 6AK5 SHARP-CUTOFF PENTODE

## 6AK5/ EF95

Miniature types used as rf or if amplifiers especially in high-frequency wide-band applications at frequencies up to 400 MHz. Outlines section, 5B; require miniature 7-contact socket.



7BD

Heater Voltage (ac/dc) .....	6.3	volts
Heater Current .....	0.175	ampere
Peak Heater-Cathode Voltage .....	$\pm 90$ max	volts
Direct Interelectrode Capacitances (Approx.):*		
Grid No.1 to Plate .....	0.02 max	pF
Grid No.1 to Cathode, Heater, Grid No.2, Grid No.3, and Internal Shield .....	4.0	pF
Plate to Cathode, Heater, Grid No.2, Grid No.3, and Internal Shield .....	2.8	pF

\* With external shield connected to pin 2 or 7.

### Class A<sub>1</sub> Amplifier

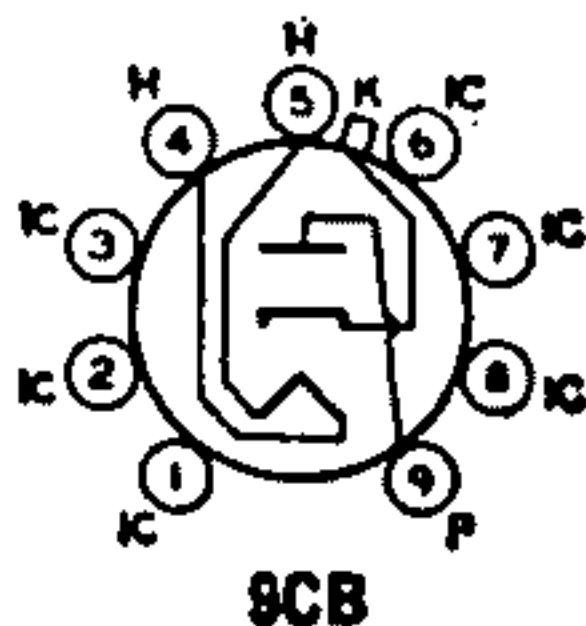
#### MAXIMUM RATINGS (Design-Center Values)

Plate Voltage .....	180	volts
Grid-No.2 (Screen-Grid) Voltage .....	See curve page 96	
Grid-No.2 Supply Voltage .....	180	volts
Grid-No.1 Voltage, Positive-bias value .....	0	volts
Plate Dissipation .....	1.7	watts
Grid-No.2 Input:		
For grid-No.2 voltages up to 90 volts .....	0.5	watt
For grid-No.2 voltages between 90 and 180 volts .....	See curve page 96	
Cathode Current .....	18	mA

#### CHARACTERISTICS

Plate Supply Voltage .....	120	180	volts
Grid-No.2 Supply Voltage .....	120	120	volts

Cathode-Bias Resistor .....	180	180	ohms
Plate Resistance (Approx.) .....	0.3	0.5	megohm
Transconductance .....	5000	5100	μmbos
Plate Current .....	7.5	7.7	mA
Grid-No.2 Current .....	2.5	2.4	mA
Grid-No.1 Voltage for plate current of 10 μA .....	-8.5	-8.5	volts



**HALF-WAVE VACUUM RECTIFIER**

**6AL3**

Miniature type used as damper tube in horizontal-deflection circuits of black-and-white television receivers. Outlines section, 7D; requires miniature 9-contact socket. Socket terminals 1, 2, 3, 6, 7, and 8 should not be used as tie points. It is especially important that this tube, like other power-handling tubes, be adequately ventilated. Heater: volts (ac/dc), 6.3; amperes, 1.55.

**Damper Service**

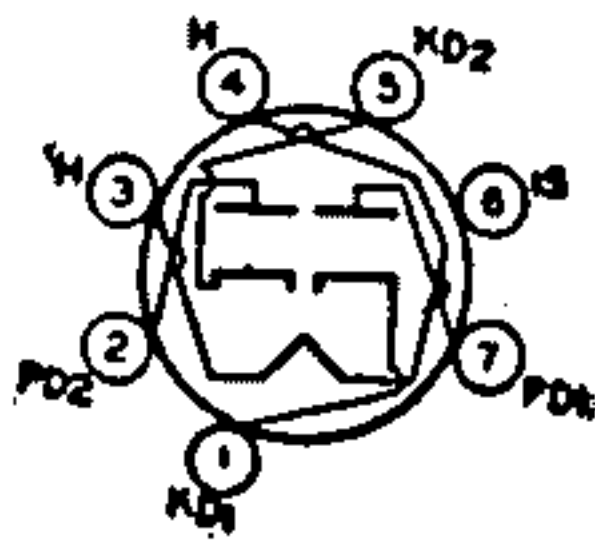
For operation in a 525-line, 30-frame system

**MAXIMUM RATINGS (Design-Center Values)**

Peak Inverse Plate Voltage# (Absolute maximum) .....	7500*	volts
Peak Plate Current .....	550	mA
Average Plate Current .....	220	mA
Plate Dissipation .....	5	watts
Peak Heater-Cathode Voltage .....	6600	volts

\* Under no circumstances should this absolute value be exceeded.

# Pulse duration must not exceed 15% of a horizontal scanning cycle (10 microseconds).



**TWIN DIODE**

**6AL5**

3AL5, 12AL5

Miniature, high-perveance type used as detector in FM and television circuits, especially as a ratio detector in ac-operated FM receivers. Each diode section can be used independently of the other, or the two sections can be combined in parallel or full-wave arrangement. Resonant frequency of each unit is approximately 700 MHz. Outlines section, 5B; requires miniature 7-contact socket. Types 3AL5 and 12AL5 are identical with type 6AL5 except for heater ratings.

Heater Voltage (ac/dc) .....	3AL5	6AL5	12AL5	volts
Heater Current .....	0.6	0.3	0.15	ampere
Heater Warm-up Time (Average) .....	11	—	—	seconds
Peak Heater-Cathode Voltage .....	±330 max	±330 max	±330 max	volts

**Direct Interelectrode Capacitances:**

Plate No.1 to Cathode No.1, Heater, and Internal Shield ....	2.5	pF
Plate No.2 to Cathode No.2, Heater, and Internal Shield ....	2.5	pF
Cathode No.1 to Plate No.1, Heater, and Internal Shield ....	3.4	pF
Cathode No.2 to Plate No.2, Heater, and Internal Shield ....	3.4	pF
Plate No.1 to Plate No.2 .....	0.068 max	pF

**Half-Wave Rectifier**

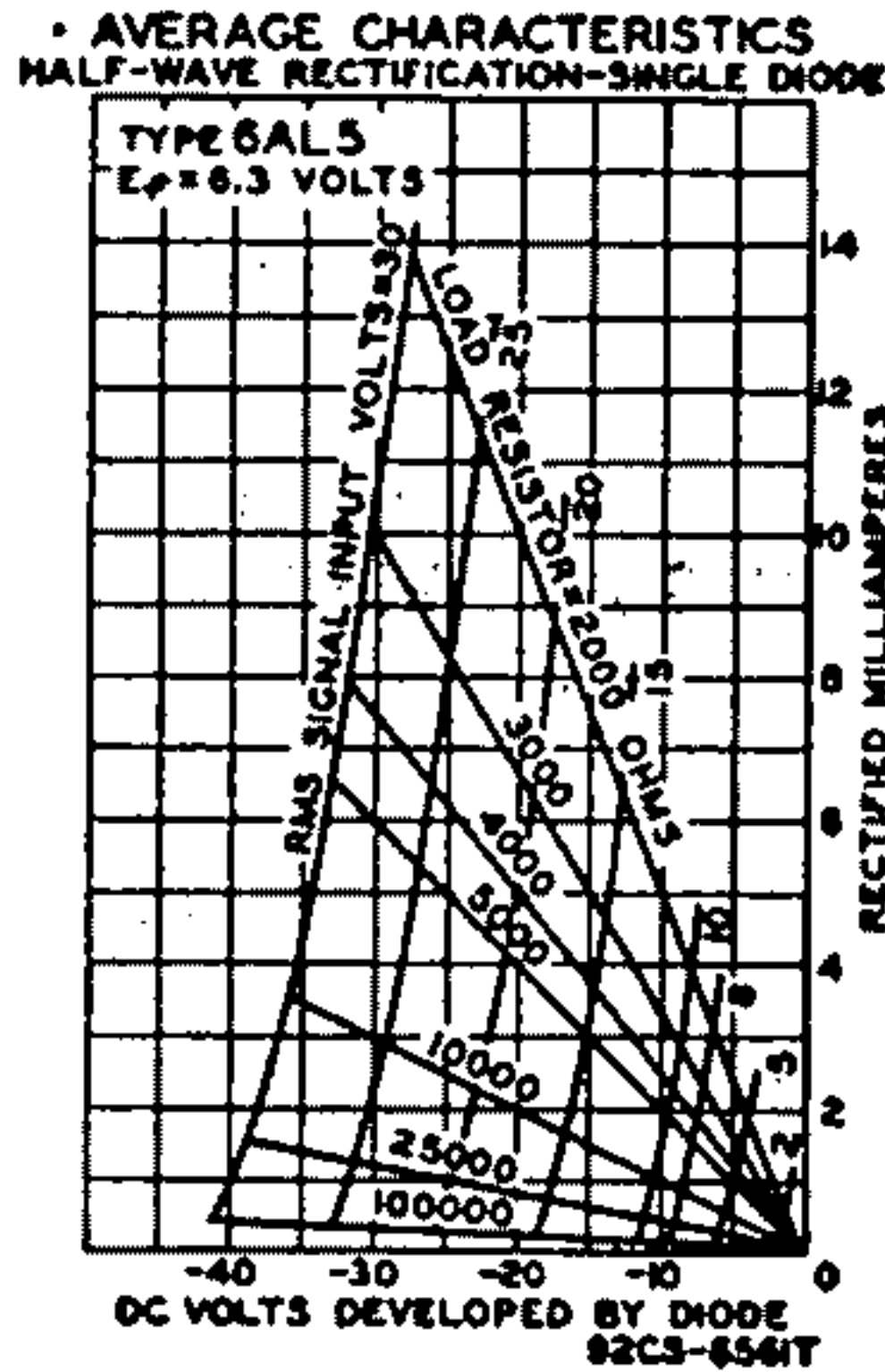
**MAXIMUM RATINGS (Design-Center Values)**

Peak Inverse Plate Voltage .....	330	volts
Peak Plate Current (Per Plate) .....	54	mA
Average Output Current (Per Plate) .....	9	mA

**TYPICAL OPERATION**

AC Plate Voltage per Plate (rms) .....	117	volts
Min. Total Effective Plate-Supply Impedance per Plate .....	300	ohms
Average Output Current per Plate .....	9	mA





**6AL7GT**

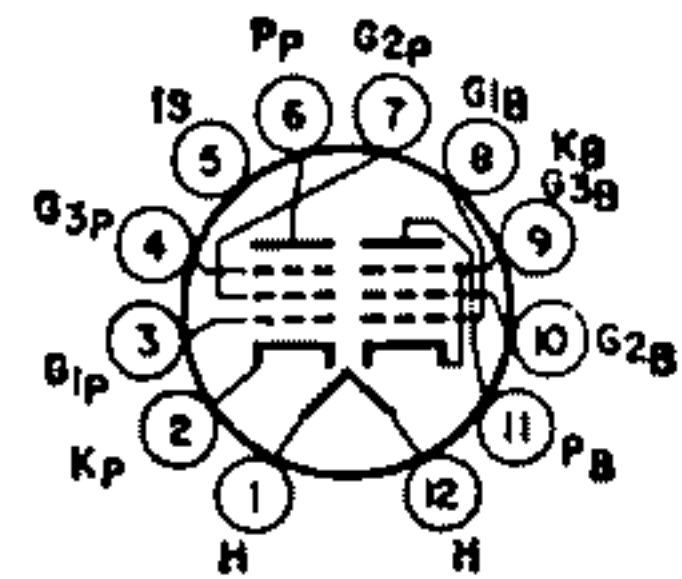
Refer to chart at end of data section.

**6AL11**

10AL11, 12AL11

**BEAM POWER TUBE—  
 SHARP-CUTOFF PENTODE**

Duodecar type used as FM detector and audio-frequency output amplifier in television receivers. Outlines section, 8C; requires duodecar 12-contact socket. Types 10AL11 and 12AL11 are identical with type 6AL11 except for heater ratings.



**12BU**

	6AL11	10AL11	12AL11	
Heater Voltage (ac/dc)	6.3	9.8	12.6	volts
Heater Current	0.9	0.6	0.45	ampere
Heater Warm-up Time (Average)	—	11	11	seconds
Heater-Cathode Voltage:				
Peak value	±200 max	±200 max	±200 max	volts
Average value	100 max	100 max	100 max	volts
Direct Interelectrode Capacitance:				
Beam Power Unit:				
Grid No.1 to Plate			0.26	pF
Grid No.1 to Cathode, Heater, Grid No.2, Grid No.3, and Internal Shield			11	pF
Plate to Cathode, Heater, Grid No.2, Grid No.3, and Internal Shield			12	pF
Pentode Unit:				
Grid No.1 to Plate			0.034	pF
Grid No.3 to Plate			2.2	pF
Grid No.1 to Cathode, Heater, Grid No.2, Grid No.3, and Internal Shield			6.6	pF
Grid No.3 to Cathode, Heater, Grid No.1, Grid No.2, Plate, and Internal Shield			7.6	pF
Grid No.1 to Grid No.3			0.24	pF
Pentode Plate to Beam Power Plate			0.12	pF

**Beam Power Unit as Class A<sub>1</sub> Amplifier**

MAXIMUM RATINGS (Design-Maximum Values)		
Plate Voltage	275	volts
Grid-No.2 (Screen-Grid) Voltage	275	volts
Plate Dissipation	10	watts
Grid-No.2 Input	2	watts

**TYPICAL OPERATION**

Plate Voltage	250	volts
Grid-No.2 Voltage	250	volts
Grid-No.1 (Control-Grid) Voltage	-8	volts
Peak AF Grid-No.1 Voltage	8	volts
Zero-Signal Plate Current	35	mA
Maximum-Signal Plate Current	39	mA
Zero-Signal Grid-No.2 Current	2.6	mA
Maximum-Signal Grid-No.2 Current	7	mA
Plate Resistance (Approx.)	0.1	megohm
Transconductance	6500	$\mu$ mhos
Load Resistance	5000	ohms
Total Harmonic Distortion	10	per cent
Maximum-Signal Power Output	4.2	watts

**MAXIMUM CIRCUIT VALUE**

Grid-No.1-Circuit Resistance:		
For fixed-bias operation	0.25	megohm
For cathode-bias operation	0.5	megohm

**Pentode Unit as Class A<sub>1</sub> Amplifier**

**CHARACTERISTICS**

Plate Supply Voltage	150	volts
Grid-No.3 (Suppressor-Grid) Voltage	0	volts
Grid-No.2 (Screen-Grid) Supply Voltage	100	volts
Cathode-Bias Resistor	560	ohms
Plate Resistance (Approx.)	0.15	megohm
Transconductance, Grid No.1 to Plate	1000	$\mu$ mhos
Transconductance, Grid No.3 to Plate	400	$\mu$ mhos
Plate Current	1.8	mA
Grid-No.2 Current	2.1	mA
Grid-No.1 Voltage (Approx.) for plate current of 30 $\mu$ A	-4.5	volts
Grid-No.3 Voltage (Approx.) for plate current of 50 $\mu$ A	-4.5	volts

**Pentode Unit as FM Detector**

**MAXIMUM RATINGS (Design-Maximum Values)**

Plate Voltage	330	volts
Grid-No.3 Voltage	28	volts
Grid-No.2 Supply Voltage	330	volts
Grid-No.2 Voltage	See curve page 96	
Grid-No.1 (Control-Grid) Voltage, Positive-bias value	0	volts
Plate Dissipation	1.7	watts
Grid-No.2 Input:		
For grid-No.2 voltages up to 165 volts	1.1	watts
For grid-No.2 voltages between 165 and 330 volts	See curve page 96	

Refer to chart at end of section.

Refer to chart at end of section.

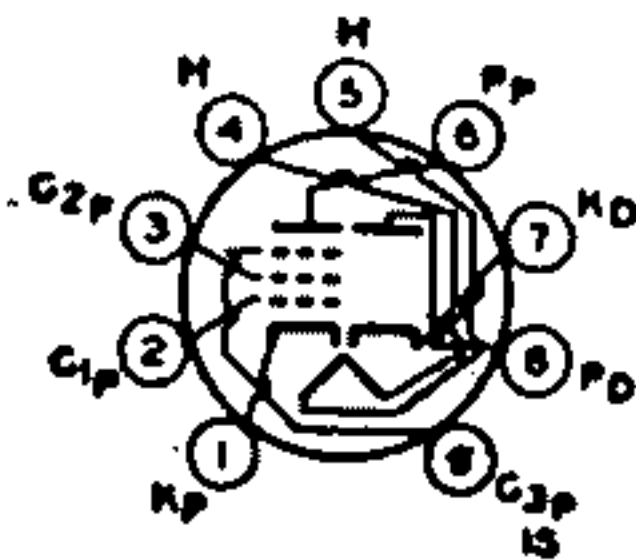
**6AM4**

**6AM8**

**6AM8A**

5AM8

**DIODE—  
SHARP-CUTOFF PENTODE**

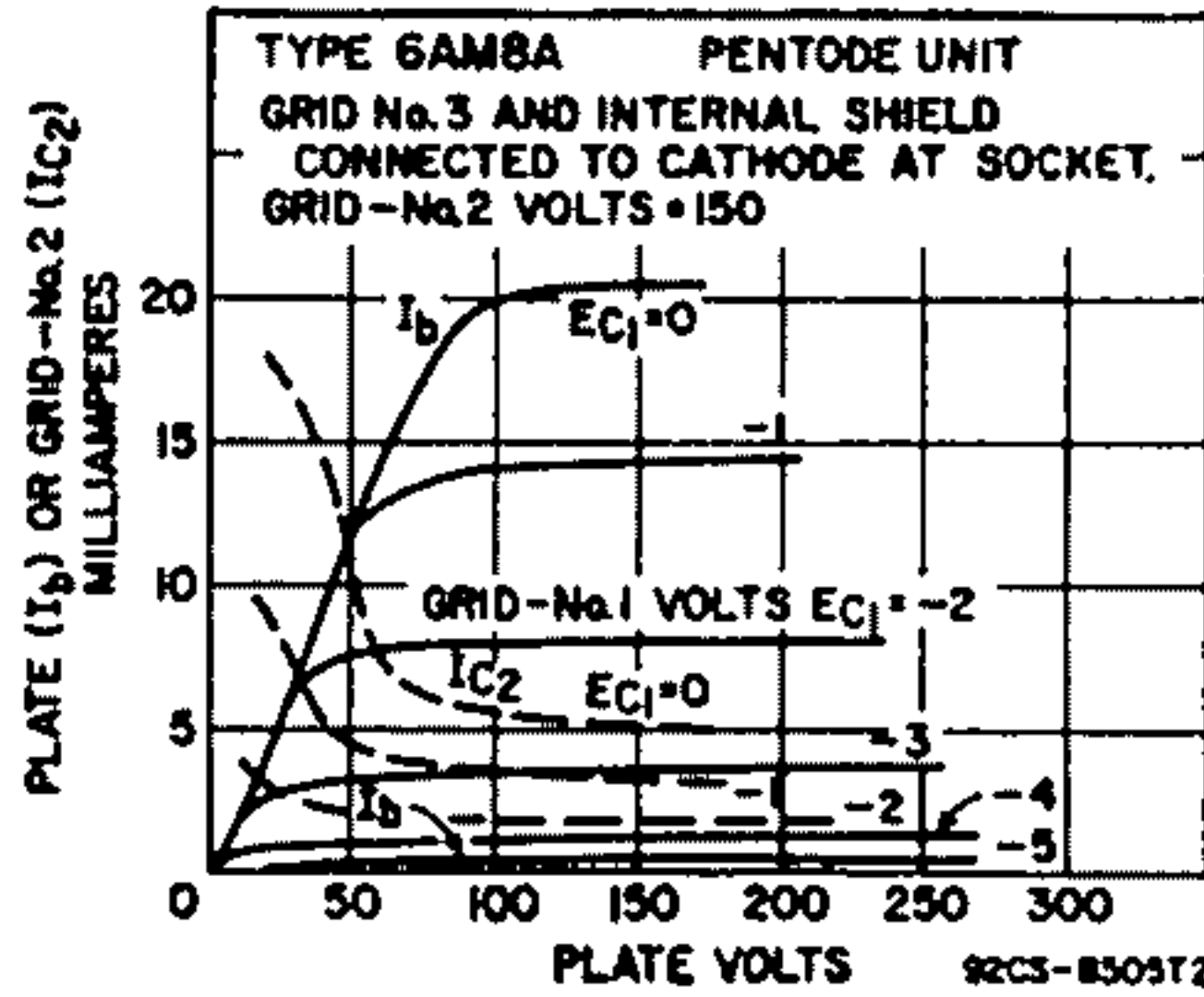


SCY

Miniature type used in television receiver applications. The pentode unit is used as an if amplifier, video amplifier, or agc amplifier. The high-perveance diode is used as an audio detector, video detector, or dc restorer. Outlines section, 6B; requires miniature 9-contact socket. Type 5AM8 is identical with type 6AM8A except for heater ratings.

Heater Voltage (ac/dc)	5AM8 4.7	6AM8A 6.3	volts
Heater Current	0.6	0.45	ampere
Heater Warm-up Time (Average)	100 max	100 max	volts
Heater-Cathode Voltage:			
Peak value	$\pm$ 200 max	$\pm$ 200 max	volts
Average value	100 max	100 max	volts
Direct Interelectrode Capacitances:			
Diode Unit:			
Plate to Cathode and Heater		1.8	pF
Cathode to Plate and Heater		3	pF
Pentode Unit:			
Grid No.1 to Plate		0.015	pF
Grid No.1 to Cathode, Heater, Grid No.2, Grid No.3 and Internal Shield		6.5	pF
Plate to Cathode, Heater, Grid No.2, Grid No.3, and Internal Shield		2.6	pF

Pentode Grid No.1 to Diode Plate .....	0.006	PF
Pentode Plate to Diode Cathode .....	0.16	PF
Pentode Plate to Diode Plate .....	0.1	PF



**Pentode Unit as Class A<sub>1</sub> Amplifier**

**MAXIMUM RATINGS (Design-Maximum Values)**

Plate Voltage .....	330	volts
Grid-No.3 (Suppressor-Grid) Voltage, Positive value .....	0	volts
Grid-No.2 (Screen-Grid) Supply Voltage .....	330	volts
Grid-No.2 Voltage .....	See curve page 96	
Grid-No.1 (Control-Grid) Voltage, Positive-bias value .....	0	volts
Plate Dissipation .....	3.2	watts
Grid-No.2 Input:		
For grid-No.2 voltages up to 165 volts .....	0.55	watt
For grid-No.2 voltages between 165 and 330 volts .....	See curve page 96	

**CHARACTERISTICS**

Plate Supply Voltage .....	125	volts
Grid No.3 .....	Connected to cathode at socket	
Grid-No.2 Supply Voltage .....	125	volts
Cathode-Bias Resistor .....	56	ohms
Plate Resistance (Approx.) .....	0.8	megohm
Transconductance .....	7800	$\mu$ mbos
Plate Current .....	12.5	mA
Grid-No.2 Current .....	3.2	mA
Grid-No.1 Voltage (Approx.) for plate current of 20 $\mu$ A .....	-6	volts
Grid-No.1 Voltage (Approx.) for plate current of 2 mA .....	-3	volts

**MAXIMUM CIRCUIT VALUES**

Grid-No.1-Circuit Resistance:		
For fixed-bias operation .....	0.25	megohm
For cathode-bias operation .....	1.0	megohm

**Diode Unit**

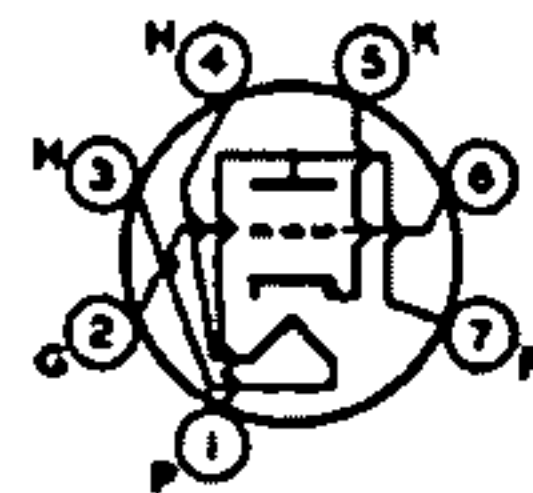
**MAXIMUM RATINGS (Design-Maximum Values)**

Average Plate Current .....	5	mA
-----------------------------	---	----

**6AN4**

**HIGH-MU TRIODE**

Miniature type used as mixer or rf amplifier in cathode-drive circuits of uhf television tuners covering the frequency range of 470 to 890 MHz. Outlines section, 5B; requires miniature 7-contact socket.



**7DK**



Heater Voltage (ac/dc) .....	6.3	volts
Heater Current .....	0.225	ampere
Heater-Cathode Voltage:		
Peak value .....	±200 max	volts
Average value .....	100 max	volts
Direct Interelectrode Capacitances:		
Grid to Plate .....	1.7°	pF
Grid to Cathode and Heater .....	3.2°	pF
Plate to Cathode and Heater .....	1.8°	pF
Heater to Cathode .....	2.9 <sup>▲</sup>	pF
Grid to Cathode .....	2.6 <sup>▲</sup>	pF
Plate to Cathode .....	0.18 <sup>▲</sup>	pF
Cathode to Grid and Heater .....	5.7*	pF
Plate to Grid and Heater .....	8.4*	pF

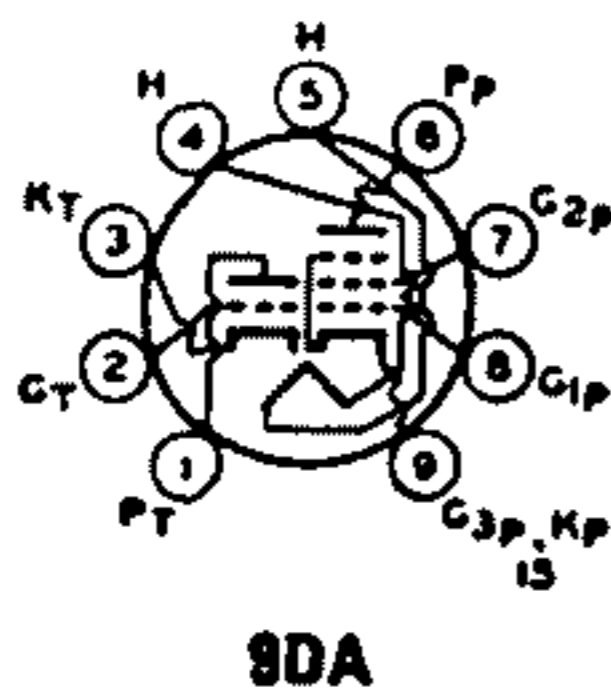
- \* With external shield connected to cathode.
- ▲ With external shield connected to ground.
- ° With external shield connected to grid.

**Class A<sub>1</sub> Amplifier**

<b>MAXIMUM RATINGS (Design-Center Values)</b>		
Plate Voltage .....	300	volts
Cathode Current .....	30	mA
Plate Dissipation .....	4	watts
<b>CHARACTERISTICS</b>		
Plate-Supply Voltage .....	200	volts
Cathode-Bias Resistor .....	100	ohms
Amplification Factor .....	70	
Transconductance .....	10000	μmhos
Plate Current .....	13	mA
Grid Voltage (Approx.) for plate current of 20 μA .....	-7	volts
<b>MAXIMUM CIRCUIT VALUES</b>		
Grid-Circuit Resistance:		
For fixed-bias operation .....	0.1	megohm
For cathode-bias operation .....	0.5	megohm

Refer to chart at end of section.

**6AN8**



**9DA**

**MEDIUM-MU TRIODE SHARP-CUTOFF PENTODE**

**6AN8A**

5AN8

Miniature type used in color television receiver applications. The pentode unit is used as an intermediate-frequency amplifier, a video amplifier, an agc amplifier, or a reactance tube. The triode unit is used in low-frequency oscillator, sync-separator, sync-clipper, and phase-splitter circuits. Outlines section, 6B; requires miniature 9-contact socket. Type 5AN8 is identical with 6AN8A except for heater ratings.

	<b>5AN8</b>	<b>6AN8A</b>	
Heater Voltage (ac/dc) .....	4.7	6.3	volts
Heater Current .....	0.6	0.45	ampere
Heater Warm-up Time (Average) .....	11	11	seconds
Heater-Cathode Voltage:			
Peak value .....	±200 max	±200 max	volts
Average value .....	100 max	100 max	volts
Direct Interelectrode Capacitances:			
Triode Unit:			
Grid to Plate .....	1.5		pF
Grid to Cathode and Heater .....	2.0		pF
Plate to Cathode and Heater .....	0.28		pF
Pentode Unit:			
Grid No.1 to Plate .....	0.04 max		pF
Grid No.1 to Cathode, Heater, Grid No.2, Grid No.3, and Internal Shield .....	7		pF
Plate to Cathode, Heater, Grid No.2, Grid No.3, and Internal Shield .....	2.4		pF
Triode Grid to Pentode Plate .....	0.02		pF
Pentode Grid No.1 to Triode Plate .....	0.02		pF
Pentode Plate to Triode Plate .....	0.15		pF

**Class A<sub>1</sub> Amplifier**

**MAXIMUM RATINGS (Design-Maximum Values)**

Plate Voltage	330	330	volts
Grid-No.2 Supply Voltage	—	330	volts
Grid-No.2 (Screen-Grid) Voltage	—	—See curve page 96	
Grid-No.1 (Control-Grid) Voltage, Positive-bias value	0	0	volts
Plate Dissipation	2.8	2.3	watts
Grid-No.2 Input:			
For grid-No.2 voltages up to 165 volts	—	0.55	watt
For grid-No.2 voltages between 165 and 330 volts	—	—See curve page 96	

Triode Unit	Pentode Unit	
330	330	volts
—	330	volts
—	—See curve page 96	
0	0	volts
2.8	2.3	watts
—	0.55	watt
—	—See curve page 96	

**CHARACTERISTICS**

Plate Supply Voltage	150	125	volts
Grid-No.2 Supply Voltage	—	125	volts
Grid-No.1 Voltage	—8	—	volts
Cathode-Bias Resistor	—	56	ohms
Amplification Factor	21	—	
Plate Resistance (Approx.)	4700	170000	ohms
Transconductance	4500	7800	μmhos
Plate Current	15	12	mA
Grid-No.2 Current	—	3.8	mA
Grid-No.1 Voltage (Approx.) for plate current of 20 μA	—17	—6	volts
Grid-No.1 Voltage (Approx.) for plate current of 1.6 mA	—	—3	volts

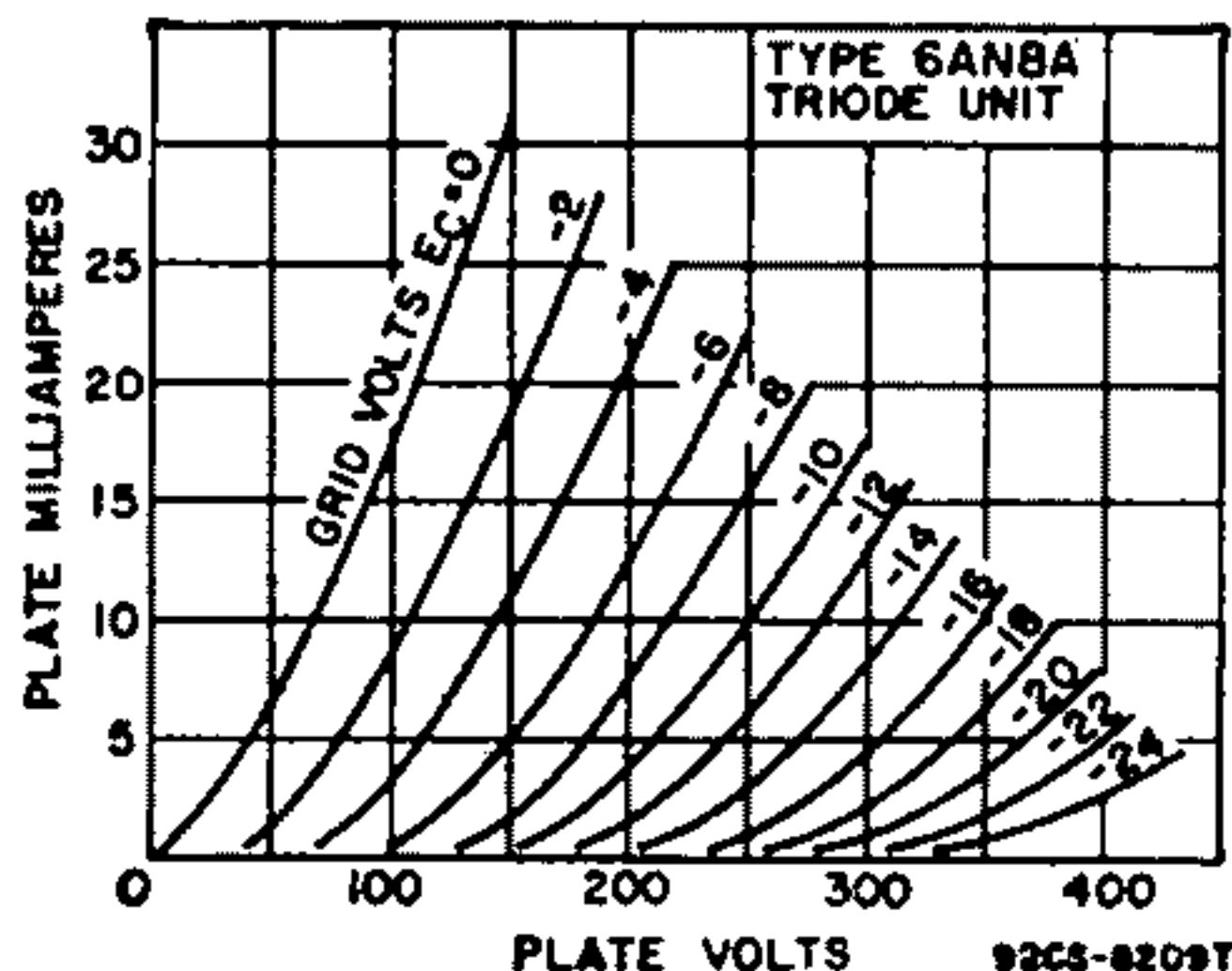
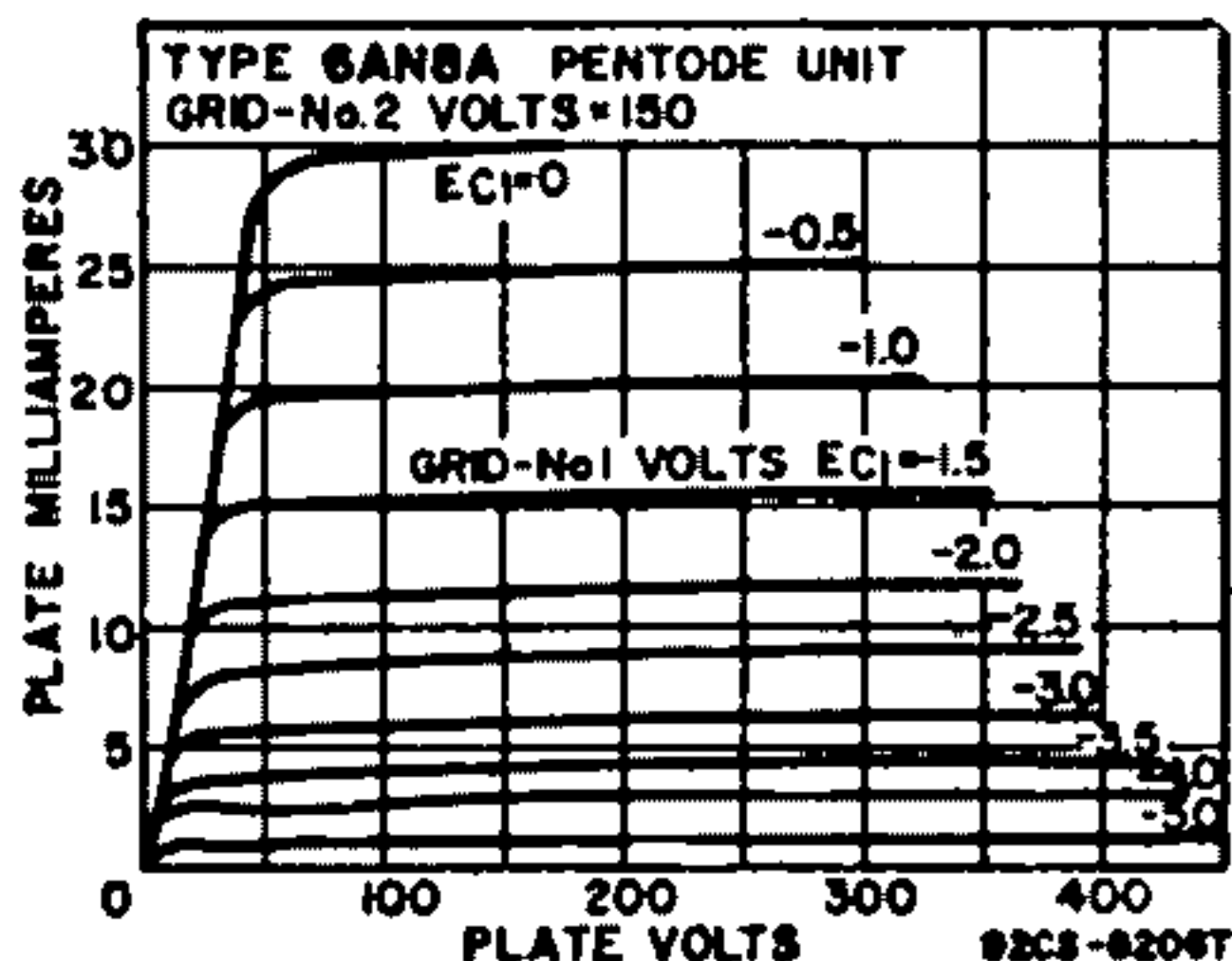
150	125	volts
—	125	volts
—8	—	volts
—	56	ohms
21	—	
4700	170000	ohms
4500	7800	μmhos
15	12	mA
—	3.8	mA
—17	—6	volts
—	—3	volts

**MAXIMUM CIRCUIT VALUES**

Grid-No.1-Circuit Resistance:*			
For fixed-bias operation	0.5	0.25	megohm
For cathode-bias operation	1.0	1.0	megohm

0.5	0.25	megohm
1.0	1.0	megohm

\* If either unit is operating at maximum rated conditions, grid-No.1-circuit resistance for both units should not exceed the stated values.



**6AQ5**

Refer to chart at end of section.

**6AQ5A**

**BEAM POWER TUBE**

5AQ5, 12AQ5

Miniature type used as output amplifier primarily in automobile receivers and in ac-operated receivers and, triode-connected, as a vertical-deflection amplifier in television receivers. Outlines section, 5D; requires miniature 7-contact socket. Within its maximum ratings, the performance of this type is equivalent to that of larger types 6V6 and 6V6GTA. Types 5AQ5 and 12AQ5 are identical with type 6AQ5A except for heater ratings.



**7BZ**

	5AQ5	6AQ5A	12AQ5	
Heater Voltage (ac/dc)	4.7	6.3	12.6	volts
Heater Current	0.6	0.45	0.225	ampere
Heater Warm-up Time (Average)	11	11	—	seconds
Heater-Cathode Voltage:				
Peak value	±200 max	±200 max	±200 max	volts
Average value	100 max	100 max	100 max	volts

Direct Interelectrode Capacitances (Approx.):

Grid No.1 to Plate .....	0.4	pF
Grid No.1 to Cathode, Heater, Grid No.2, and Grid No.3 .....	8	pF
Plate to Cathode, Heater, Grid No.2, and Grid No.3 .....	8.5	pF

**Class A<sub>1</sub> Amplifier**

**MAXIMUM RATINGS (Design-Maximum Values)**

Plate Voltage .....	275	volts
Grid-No.2 (Screen-Grid) Voltage .....	275	volts
Plate Dissipation .....	12	watts
Grid-No.2 Input .....	2	watts
Bulb Temperature (At hottest point) .....	250	°C

**CHARACTERISTICS**

Plate Voltage .....	250	volts
Grid-No.1 Voltage .....	-12.5	volts
Amplification Factor .....	9.5	
Plate Resistance (Approx.) .....	1970	ohms
Transconductance .....	4800	μmhos
Plate Current .....	49.5	ma
Grid-No.1 Voltage (Approx.) for plate current of 0.5 mA .....	-37	volts

**TYPICAL OPERATION**

Same as for type 6V6GTA within the limitations of the maximum ratings.

**MAXIMUM CIRCUIT VALUES**

Grid-No.1-Circuit Resistance:		
For fixed-bias operation .....	0.1	megohm
For cathode-bias operation .....	0.5	megohm

**Vertical Deflection Amplifier (Triode Connection)\***

For operation in a 526-line, 30-frame system

**MAXIMUM RATINGS (Design-Maximum Values)**

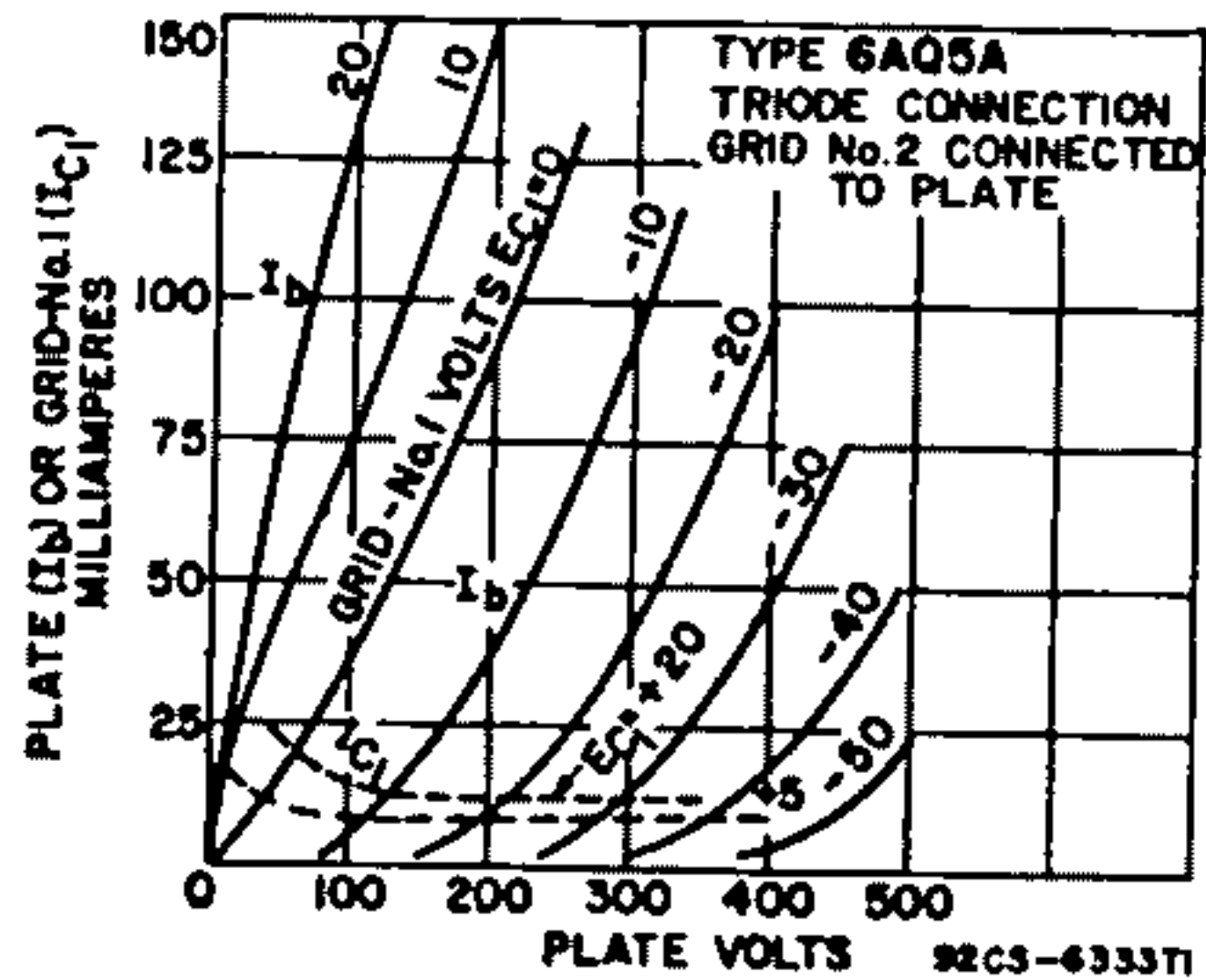
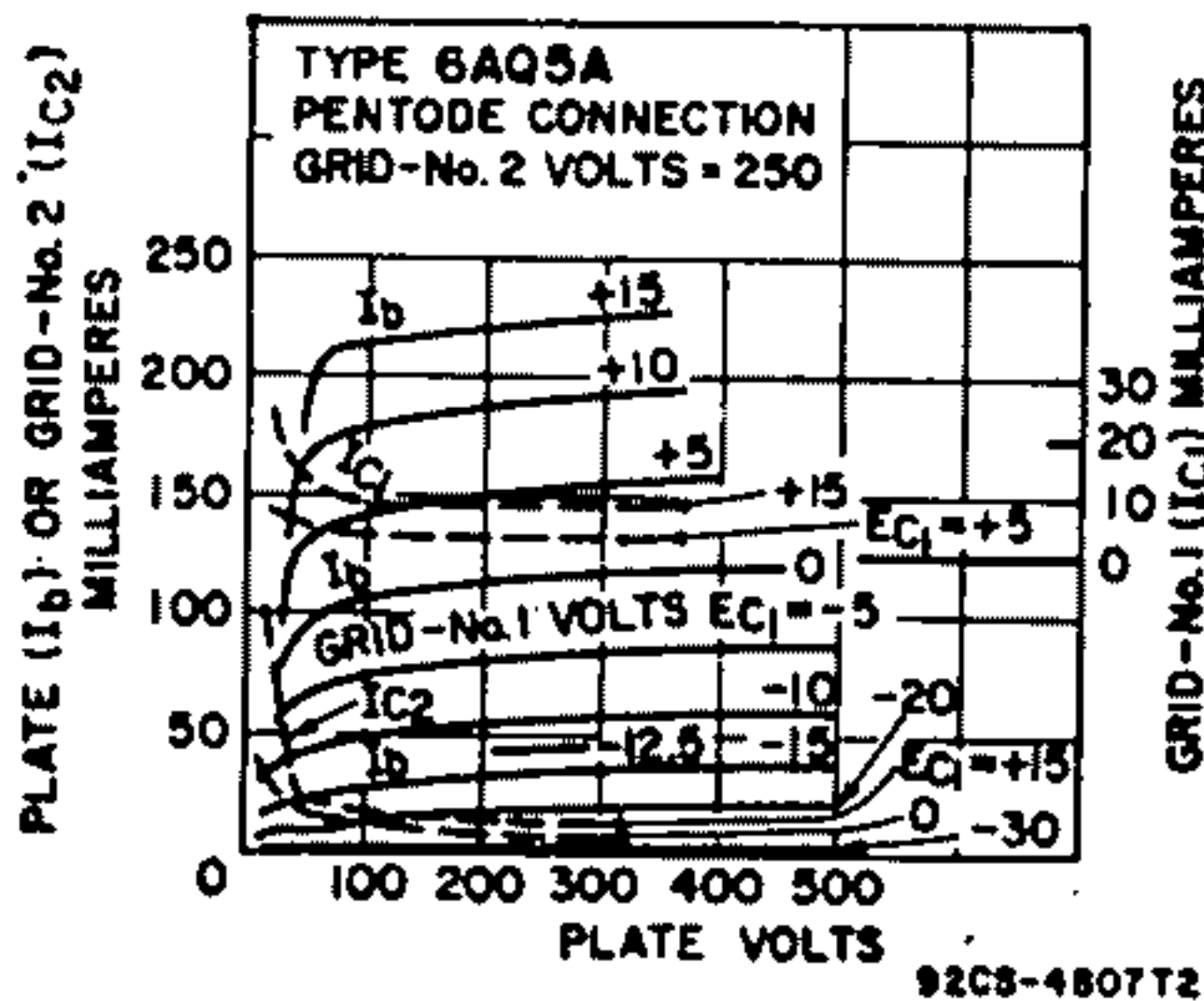
DC Plate Voltage .....	275	volts
Peak Positive-Pulse Plate Voltage# .....	1100	volts
Peak Negative-Pulse Grid-No.1 (Control-Grid) Voltage .....	-275	volts
Peak Cathode Current .....	115	mA
Average Cathode Current .....	40	mA
Plate Dissipation .....	10	watts
Bulb Temperature (At hottest point) .....	250	°C

**MAXIMUM CIRCUIT VALUE**

Grid-No.1-Circuit Resistance, for cathode-bias operation .....	2.2	megohms
--	-----	---------

\* Grid No.2 connected to plate.

# Pulse duration must not exceed 15% of a vertical scanning cycle (2.5 milliseconds).



Refer to chart at end of section.

Refer to chart at end of section.

**6AQ6**

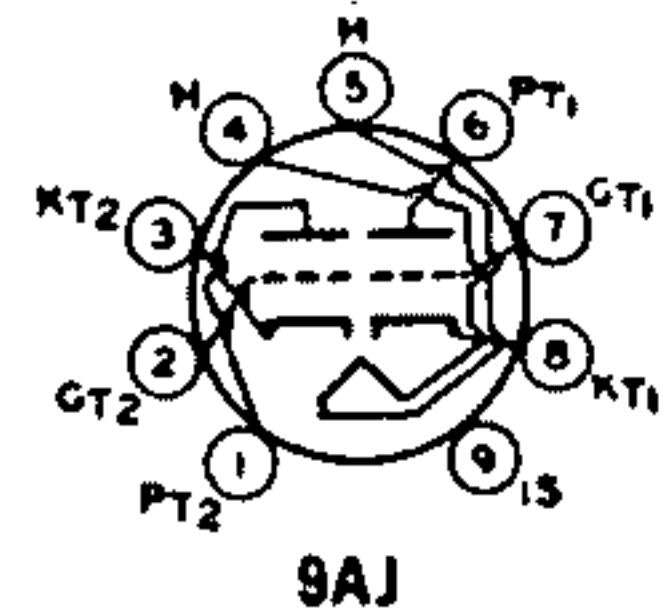
**6AQ7GT**



# 6AQ8 6AQ8/ ECC85

## HIGH-MU TWIN TRIODE

Miniature types used as rf amplifier and self-oscillating mixer in FM/AM radio receivers. Outlines section, 6B; requires 9-contact socket.



Heater Voltage (ac/dc) .....	6.3	volts	
Heater Current .....	0.435	ampere	
Peak Heater-Cathode Voltage .....	±90 max	volts	
<b>Direct Interelectrode Capacitances:</b>	<b>Unit No.1</b>	<b>Unit No.2</b>	
Grid to Plate .....	1.5	1.5	pF
Cathode to Plate .....	0.18	0.18	pF
Grid to Cathode, Heater, and Internal Shield ..	3	3	pF
Plate to Cathode, Heater, and Internal Shield ..	1.2	1.2	pF
Plate to Grid of Other Unit .....	0.008 max	0.008 max	pF
Plate to Cathode of Other Unit .....	0.008 max	0.008 max	pF
Grid to Cathode of Other Unit .....	0.003 max	0.003 max	pF
Plate of Unit No.1 to Plate of Unit No.2 .....		0.04 max	pF
Grid of Unit No.1 to Grid of Unit No.2 .....		0.003 max	pF

### Class A<sub>1</sub> Amplifier

#### MAXIMUM RATINGS (Design-Maximum Values, Each Unit)

Plate Supply Voltage .....	550	volts
Plate Voltage .....	300	volts
Grid Voltage, Negative-bias value .....	-100	volts
Cathode Current .....	15	mA
Plate Dissipation:		
For either plate .....	2.5	watts
For both plates with both units operating .....	4.5	watts

#### CHARACTERISTICS

Plate Voltage .....	250	volts
Grid Voltage, Negative-bias value .....	-2.3	volts
Plate Current .....	10	mA
Transconductance .....	5900	μmhos
Amplification Factor .....	57	

#### TYPICAL OPERATION (Each Unit)

	RF Amplifier	Converter	
Plate Supply Voltage .....	250	250	volts
Plate Voltage .....	230	—	volts
Plate Resistor .....	1800	12000	ohms
Grid Resistor .....	—	1	megohm
Grid Voltage .....	-2	—	volts
RMS Oscillator Voltage .....	—	3	volts
Cathode-Bias Resistor .....	200	—	ohms
Plate Resistance (Approx.) .....	9700	22000	ohms
Transconductance .....	6000	—	μmhos
Conversion Transconductance .....	—	2300	μmhos
Input Resistance at frequency of 100 MHz .....	6000	15000	ohms
Plate Current .....	10	5.2	mA
Equivalent Noise Resistance .....	500	—	ohms

#### MAXIMUM CIRCUIT VALUES (Each Unit)

Grid-Circuit Resistance .....	1	megohm
Resistance between Cathode and Heater .....	20000	ohms

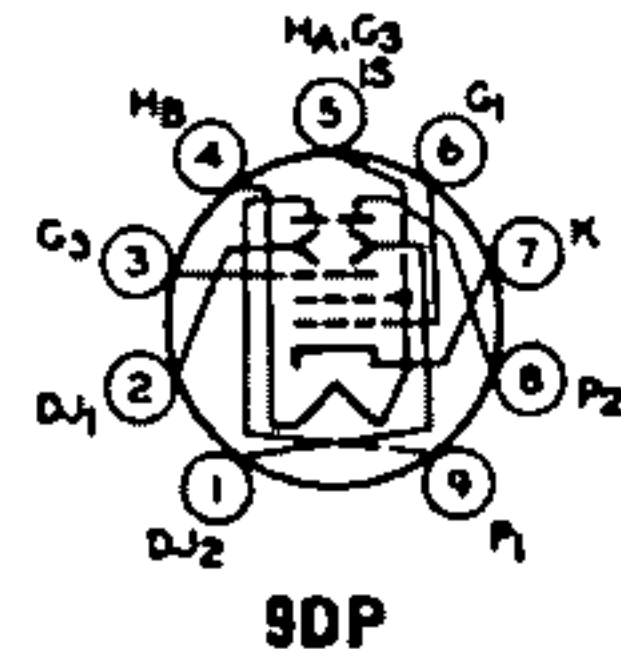
## 6AR5

Refer to chart at end of section.

# 6AR8

## BEAM-DEFLECTION TUBE

Miniature type used in color-demodulator and burst-gate circuits in color television receivers. This type has two plates and two deflecting electrodes; the control grid varies beam deflection. Outlines section, 6E; requires miniature nine-contact socket. Pin 5 should be connected to cathode at socket. The 6AR8 should be so located in the equipment that it is not subjected to stray magnetic fields. Heater: volts (ac/dc), 6.3; amperes, 0.3.



**Color TV Demodulator**

**MAXIMUM RATINGS (Design-Maximum Values)**

Plate Voltage (Each Plate) .....	300	volts
Peak Deflecting-Electrode Voltage (Each Electrode):		
Negative value .....	-150	volts
Positive value .....	150	volts
Grid-No.3 (Accelerating-Grid) Voltage .....	300	volts
Grid-No.1 (Control-Grid) Voltage, Positive-bias value .....	0	volts
Cathode Current .....	30	mA
Plate Dissipation (Each Plate) .....	2	watts
Grid-No.3 Input .....	1	watt

**MAXIMUM CIRCUIT VALUES**

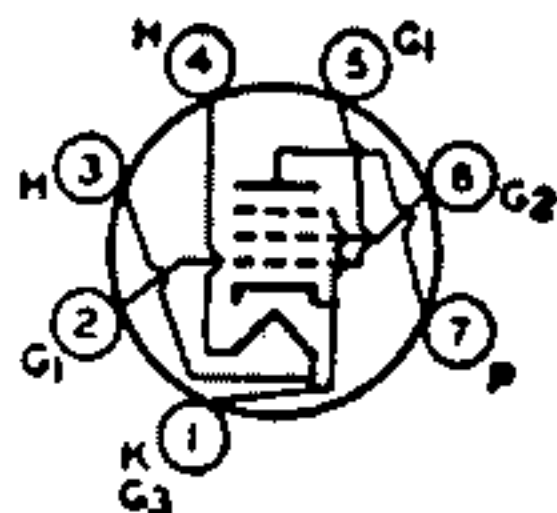
Grid-No.1 Circuit Resistance:		
For fixed-bias operation .....	0.1	megohm
For cathode-bias operation .....	0.25	megohm

**Class A<sub>1</sub> Amplifier**

With both plates connected together and with both deflecting electrodes connected to cathode at socket

**CHARACTERISTICS**

Plate-No.1 Supply Voltage .....	250	volts
Plate-No.2 Supply Voltage .....	250	volts
Grid-No.3 Voltage .....	250	volts
Cathode-Bias Resistor .....	300	ohms
Transconductance .....	4000	μmhos
Total Plate Current .....	10	mA
Grid-No.3 Current .....	0.4	mA
Grid-No.1 Voltage (Approx.) for total plate current of 10 μA .....	-14	volts



12DM

**SEMIREMOTE-CUTOFF  
TWIN PENTODE**

**6AR11**

8AR11, 11AR11

Duodecar type used as if-amplifier tube in television receivers. Outlines section, 8A; requires duodecar 12-contact-socket. Types 8AR11 and 11AR11 are identical with type 6AR11 except for heater ratings.

	6AR11	8AR11	11AR11	
Heater Voltage (ac/dc) .....	6.3	8.4	11.2	volts
Heater Current .....	0.8	0.6	0.45	ampere
Heater Warm-up Time (Average) .....	—	11	11	seconds
Heater-Cathode Voltage:				
Peak value .....	±200 max	±200 max	±200 max	volts
Average value .....	100 max	100 max	100 max	volts
Direct Interelectrode Capacitances:		Unit No.1	Unit No.2	
Grid No.1 to Plate .....		0.026	0.026	pF
Grid No.1 to Cathode, Heater, Grid No.2, Grid No. 3, and Internal Shield .....		10	10	pF
Plate to Cathode, Heater, Grid No.2, Grid No.3, and Internal Shield .....		2.8	3	pF
Grid No.1 to Plate of Other Unit .....		0.002	0.002	pF
Plate of Unit No.1 to Plate of Unit No.2 .....			0.02	pF

**Class A<sub>1</sub> Amplifier**

**MAXIMUM RATINGS (Design-Maximum Values, Each Unit)**

Plate Voltage .....	330	volts
Grid-No.3 (Suppressor-Grid) Voltage, Positive value .....	0	volts
Grid-No.2 (Screen-Grid) Supply Voltage .....	330	volts
Grid-No.2 Voltage .....	See curve page 96	
Grid-No.1 (Control-Grid) Voltage, Positive-bias value .....	0	volts
Plate Dissipation .....	3.1	watts
Grid-No.2 Input:		
For grid-No.2 voltages up to 165 volts .....	0.65	watt
For grid-No.2 voltages between 165 and 330 volts .....	See curve page 96	

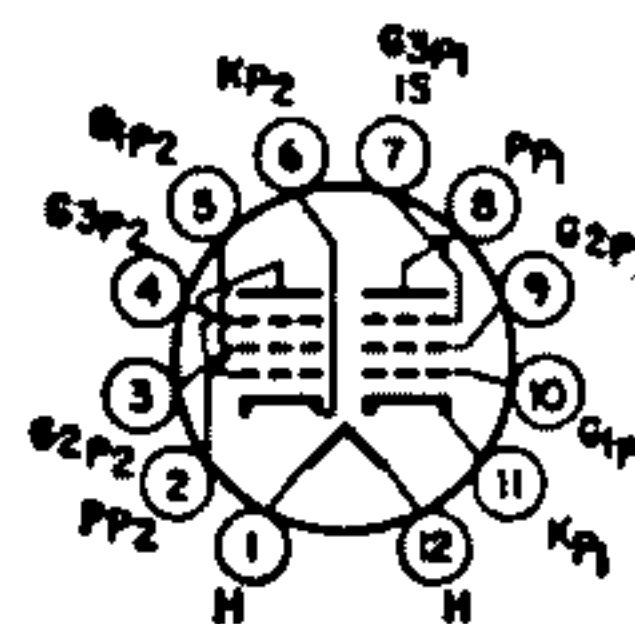
**CHARACTERISTICS (Each Unit)**

Plate Supply Voltage .....	125	volts
Grid No.3 .....	Connected to cathode at socket	

Grid-No.2 Supply Voltage .....	125	volts
Cathode-Bias Resistor .....	56	ohms
Plate Resistance (Approx.) .....	0.2	megohm
Transconductance .....	10500	$\mu$ mhos
Plate Current .....	11	mA
Grid-No.2 Current .....	3.6	mA
Grid-No.1 Voltage (Approx.) for transconductance of 50 $\mu$ mhos ..	-15	volts

## 6AS5 BEAM POWER TUBE

Miniature type used as output amplifier primarily in automobile and in ac-operated receivers. Outlines section, 5D; requires miniature 7-contact socket. For curves of average plate characteristics, refer to type 35C5.



7CV

Heater Voltage (ac/dc) .....	6.3	volts
Heater Current .....	0.8	ampere
Peak Heater-Cathode Voltage .....	$\pm 100$ max	volts
Direct Interelectrode Capacitances (Approx.):		
Grid No.1 to Plate .....	0.6	pF
Grid No.1 to Cathode, Heater, Grid No.2, and Grid No.3 .....	12	pF
Plate to Cathode, Heater, Grid No.2, and Grid No.3 .....	9.0	pF

### Class A<sub>1</sub> Amplifier

#### MAXIMUM RATINGS (Design-Center Values)

Plate Voltage .....	150	volts
Grid-No.2 (Screen-Grid) Voltage .....	117	volts
Plate Dissipation .....	5.5	watts
Grid-No.2 Input .....	1.0	watt
Bulb Temperature (At hottest point) .....	250	$^{\circ}$ C

#### TYPICAL OPERATION

Plate Voltage .....	150	volts
Grid-No.2 Voltage .....	110	volts
Grid-No.1 (Control-Grid) Voltage .....	-8.5	volts
Peak AF Grid-No.1 Voltage .....	8.5	volts
Zero-Signal Plate Current .....	35	mA
Maximum-Signal Plate Current .....	36	mA
Zero-Signal Grid-No.2 Current (Approx.) .....	2	mA
Maximum-Signal Grid-No.2 Current (Approx.) .....	6.5	mA
Transconductance .....	5600	$\mu$ mhos
Load Resistance .....	4500	ohms
Total Harmonic Distortion .....	10	per cent
Maximum-Signal Power Output .....	2.2	watts

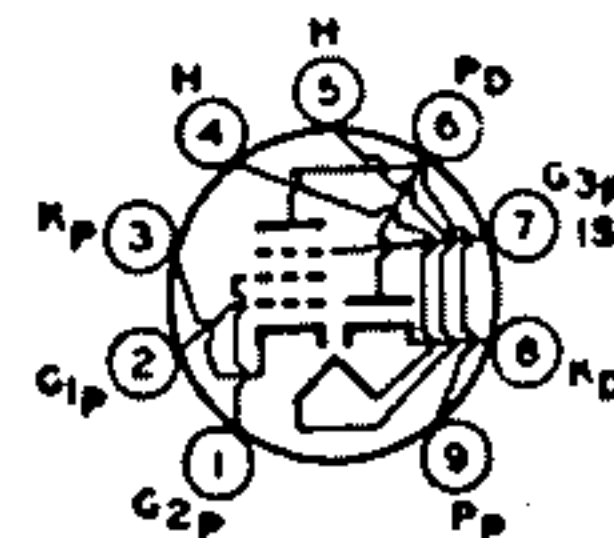
#### MAXIMUM CIRCUIT VALUES

Grid-No.1-Circuit Resistance:		
For fixed-bias operation .....	0.1	megohm
For cathode-bias operation .....	0.5	megohm

## 6AS8 DIODE—SHARP-CUTOFF PENTODE

5AS8

Miniature type used in television and radio receiver applications. The pentode unit is used as an if amplifier, video amplifier, or agc amplifier. The high-perveance diode is used as an audio detector, video detector, or dc restorer. Outlines section, 6B; requires miniature 9-contact socket. For curve of average plate characteristics of pentode unit, see type 6AN8A. Type 5AS8 is identical with type 6AS8 except for heater ratings.



9DS

Heater Voltage (ac/dc) .....	5AS8	6AS8	
Heater Current .....	4.7	6.8	volts
Heater Warm-up Time (Average) .....	0.6	0.45	ampere
Heater-Cathode Voltage:			seconds
Peak value .....	$\pm 200$ max	$\pm 200$ max	volts
Average value .....	100 max	100 max	volts



Direct Interelectrode Capacitances:

Diode Unit:		
Plate to Cathode, Heater, Pentode Grid No.3, and Internal Shield .....	3.0	pF
Pentode Unit:		
Grid No.1 to Plate .....	0.03	pF
Grid No.1 to Cathode, Heater, Grid No.2, Grid No.3, and Internal Shield .....	7	pF
Plate to Cathode, Heater, Grid No.2, Grid No.3, and Internal Shield .....	2.4	pF
Pentode Grid No.1 to Diode Plate .....	0.005 max	pF
Pentode Plate to Diode Cathode .....	0.15 max	pF
Pentode Plate to Diode Plate .....	0.10 max	pF

Pentode Unit as Class A<sub>1</sub> Amplifier

MAXIMUM RATINGS (Design-Center Values)

Plate Voltage .....	300	volts
Grid-No.3 (Suppressor-Grid) Voltage, Positive value .....	0	volts
Grid-No.2 Supply Voltage .....	300	volts
Grid-No.2 (Screen-Grid) Voltage .....	See curve page 96	
Grid-No.1 (Control-Grid) Voltage, Positive-bias value .....	0	volts
Plate Dissipation .....	2.5	watts
Grid-No.2 Input:		
For grid-No.2 voltages up to 150 volts .....	0.5	watt
For grid-No.2 voltages between 150 and 300 volts .....	See curve page 96	

CHARACTERISTICS

Plate Supply Voltage .....	200	volts
Grid No.3 .....	Connected to cathode at socket	
Grid-No.2 Supply Voltage .....	150	volts
Cathode-Bias Resistor .....	180	ohms
Plate Resistance (Approx.) .....	200000	ohms
Transconductance .....	6200	μmhos
Plate Current .....	9.5	mA
Grid-No.2 Current .....	3	mA
Grid-No.1 Voltage (Approx.) for plate current of 10 μA .....	-8	volts

MAXIMUM CIRCUIT VALUES

Grid-No.1-Circuit Resistance:		
For fixed-bias operation .....	0.25	megohm
For cathode-bias operation .....	1.0	megohm

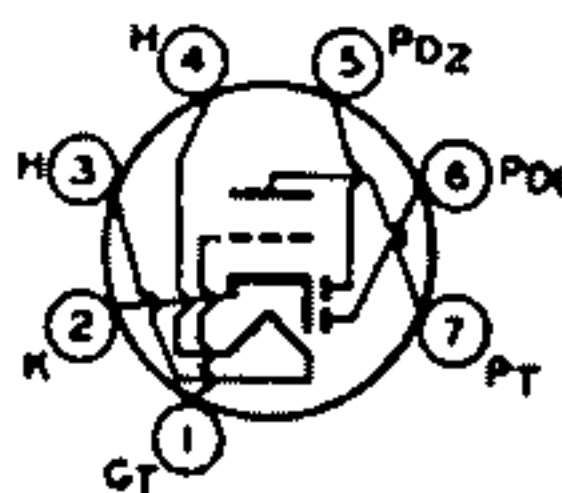
Diode Unit

MAXIMUM RATINGS (Design-Center Values)

Peak Inverse Plate Voltage .....	330	volts
Peak Plate Current .....	50	mA
Average Plate Current .....	5	mA

6AS11

Refer to chart at end of section.



7BT

TWIN DIODE—  
HIGH-MU TRIODE

6AT6

12AT6

Miniature type used as a combined detector, amplifier, and avc tube in automobile and ac-operated radio receivers. Outlines section, 5C; requires miniature 7-contact socket. For typical operation as resistance-coupled amplifier refer to Resistance-Coupled Amplifier section. Type 12AT6 is identical with type 6AT6 except for heater ratings.

Heater Voltage (ac/dc) .....	6.3	12.6	volts
Heater Current .....	0.8	0.15	ampere
Peak Heater-Cathode Voltage .....	±90 max	±90 max	volts
Direct Interelectrode Capacitances:			
Triode Grid to Triode Plate .....	2.0		pF
Triode Grid to Cathode and Heater .....	2.2		pF
Triode Plate to Cathode and Heater .....	0.8		pF
Plate of Diode Unit No.2 to Triode Grid .....	0.04 max		pF

Triode Unit as Class A<sub>1</sub> Amplifier

MAXIMUM RATINGS (Design-Center Values)

Plate Voltage .....	300	volts
Plate Dissipation .....	0.5	watts
Grid Voltage, Positive-bias value .....	0	volts

**CHARACTERISTICS**

Plate Voltage .....	100	250	volts
Grid Voltage .....	-1	-3	volts
Amplification Factor .....	70	70	
Plate Resistance .....	54000	58000	ohms
Transconductance .....	1300	1200	μmhos
Plate Current .....	0.8	1.0	mA

**Diode Units**

**MAXIMUM RATING (Design-Center Value)**

Plate Current (Each Unit) .....	1.0	mA
---------------------------------	-----	----

The two diode plates are placed around a cathode whose sleeve is common to the triode unit. Each diode plate has its own base pin. For diode operation curves, refer to type 6AV6.

**6AT8**

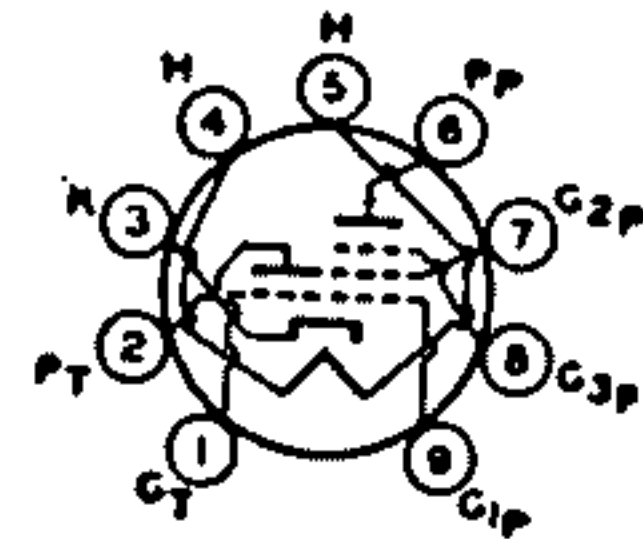
Refer to chart at end of section.

**6AT8A**

5AT8

**MEDIUM-MU TRIODE—  
SHARP-CUTOFF PENTODE**

Miniature types used as combined oscillator and mixer tubes in television receivers utilizing an intermediate frequency in the order of 40 MHz. Outlines section, 6B; requires miniature 9-contact socket. Except for interelectrode capacitances and basing arrangement, this type is identical with miniature type 6X8. The basing arrangement is particularly suitable for connection to the coils of certain designs of turret tuners. Type 5AT8 is identical with type 6AT8A except for heater ratings.



**9DW**

Heater Voltage (ac/dc) .....	5AT8 4.7	6AT8A 6.3	volts
Heater Current .....	0.6	0.45	ampere
Heater Warm-up Time (Average) .....	11	11	seconds
Direct Interelectrode Capacitances:			
Triode Unit:	Unshielded	Shielded*	
Grid to Plate .....	1.5	1.5	pF
Grid to Cathode and Heater .....	2.0	2.4	pF
Plate to Cathode and Heater .....	0.5	1.0	pF
Pentode Unit:			
Grid No.1 to Plate .....	0.08 max	0.08 max	pF
Grid No.1 to Cathode, Heater, Grid No.2 and Grid No.3 .....	4.6	4.8	pF
Plate to Cathode, Heater, Grid No.2, and Grid No.3 .....	0.9	1.6	pF
Pentode Grid No.1 to Triode Plate .....	0.05 max	0.04 max	pF
Pentode Plate to Triode Plate .....	0.05 max	0.008 max	pF
Heater to Cathode .....	6.0	6.0†	pF

\* With external shield connected to cathode except as noted.  
† With external shield connected to plate.

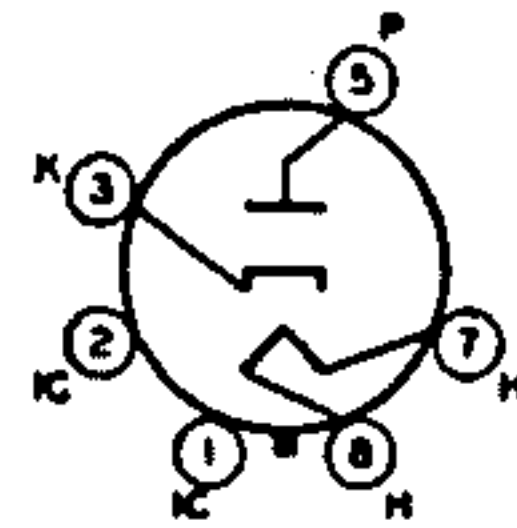
**6AU4GT**

Refer to chart at end of section.

**6AU4GTA**

**HALF-WAVE  
VACUUM RECTIFIER**

Glass octal type used as damper tube in horizontal-deflection circuits of color and wide-angle picture-tube television receivers. Outlines section, 13G; requires octal socket. Type may be supplied with pin No. 1 omitted. Socket terminals 1, 2, 4, and 6 should not be used as tie points. This tube, like other power-handling tubes, should be adequately ventilated.



**4CG**

Heater Voltage (ac/dc) .....	6.3	volts
Heater Current .....	1.8	amperes
Direct Interelectrode Capacitances (Approx.):		
Plate to Heater and Cathode .....	8.5	pF
Cathode to Heater and Plate .....	11.5	pF
Heater to Cathode .....	4	pF

**Damper Service**

For operation in a 525-line, 30-frame system

**MAXIMUM RATINGS (Design-Maximum Values)**

Peak Inverse Plate Voltage#	4500	volts
Peak Plate Current	1300	mA
Average Plate Current	210	mA
Plate Dissipation	6.5	watts
<b>Heater-Cathode-Voltage:</b>		
Peak value	+300      -4500	volts
Average value	+100      -900	volts

# Pulse duration must not exceed 15% of a horizontal scanning cycle (10 microseconds).



**6CK**

**BEAM POWER TUBE**

**6AU5GT**

Glass octal type used as horizontal-deflection amplifier in low-cost, high-efficiency deflection circuits of television receivers. Outlines section, 13D; requires octal socket.

Heater Voltage (ac/dc)	6.3	volts
Heater Current	1.25	amperes
<b>Heater-Cathode Voltage:</b>		
Peak value	±200 max	volts
Average value	100 max	volts
<b>Direct Interelectrode Capacitances (Approx.):</b>		
Grid No.1 to Plate	0.6	pF
Grid No.1 to Cathode, Heater, Grid No.2, and Grid No.3	11.8	pF
Plate to Cathode, Heater, Grid No.2, and Grid No.3	7.0	pF

**Class A<sub>1</sub> Amplifier**

**CHARACTERISTICS**

	<b>Pentode Connection</b>	<b>Triode† Connection</b>	
Plate Voltage	115	110	volts
Grid-No.2 (Screen-Grid) Voltage	175	100	volts
Grid-No.1 (Control-Grid) Voltage	-20	-4.5	volts
Plate Resistance	6000	—	ohms
Transconductance	5600	—	μmhos
Plate Current	60	—	mA
Grid No.2 Current	6.8	—	mA

† Grid No.2 connected to plate.

**Horizontal-Deflection Amplifier**

For operation in a 525-line, 30-frame system

**MAXIMUM RATINGS (Design-Center Values)**

DC Plate Voltage	550	volts
Peak Positive-Pulse Plate Voltage# (Absolute Maximum)	5500*	volts
Peak Negative-Pulse Plate Voltage	-1250	volts
DC Grid-No.2 (Screen-Grid) Voltage*	200	volts
Peak Negative-Pulse Grid-No.1 (Control-Grid) Voltage	-300	volts
Peak Cathode Current	400	mA
Average Cathode Current	110	mA
Grid-No.2 Input	2.5	watts
Plate Dissipation††	10	watts
Bulb Temperature (At hottest point)	210	°C

**MAXIMUM CIRCUIT VALUE**

Grid-No.1-Circuit Resistance	0.47	megohm
------------------------------	------	--------

# Pulse duration must not exceed 15% of a horizontal scanning cycle (10 microseconds).

\* Under no circumstances should this absolute value be exceeded.

• Obtained through a series dropping resistor of sufficient magnitude to limit the grid-No.2 input to the rated maximum value.

†† A bias resistor or other means is required to protect the tube in absence of excitation.

Refer to chart at end of section.

**6AU6**

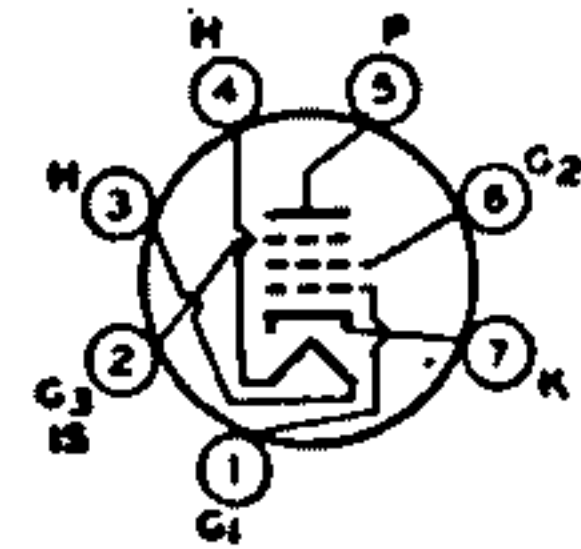


# 6AU6A

3AU6, 4AU6, 12AU6

## SHARP-CUTOFF PENTODE

Miniature type used in compact radio equipment as rf amplifier especially in high-frequency, wide-band applications; also used as limiter tube in FM equipment. Outlines section, 5C; requires miniature 7-contact socket. For a discussion of limiters, refer to *Electron Tube Applications* section. For typical operation as resistance-coupled amplifier, refer to *Resistance-Coupled Amplifier* section. Types 3AU6, 4AU6, and 12AU6 are identical with type 6AU6A except for heater ratings.



7BK

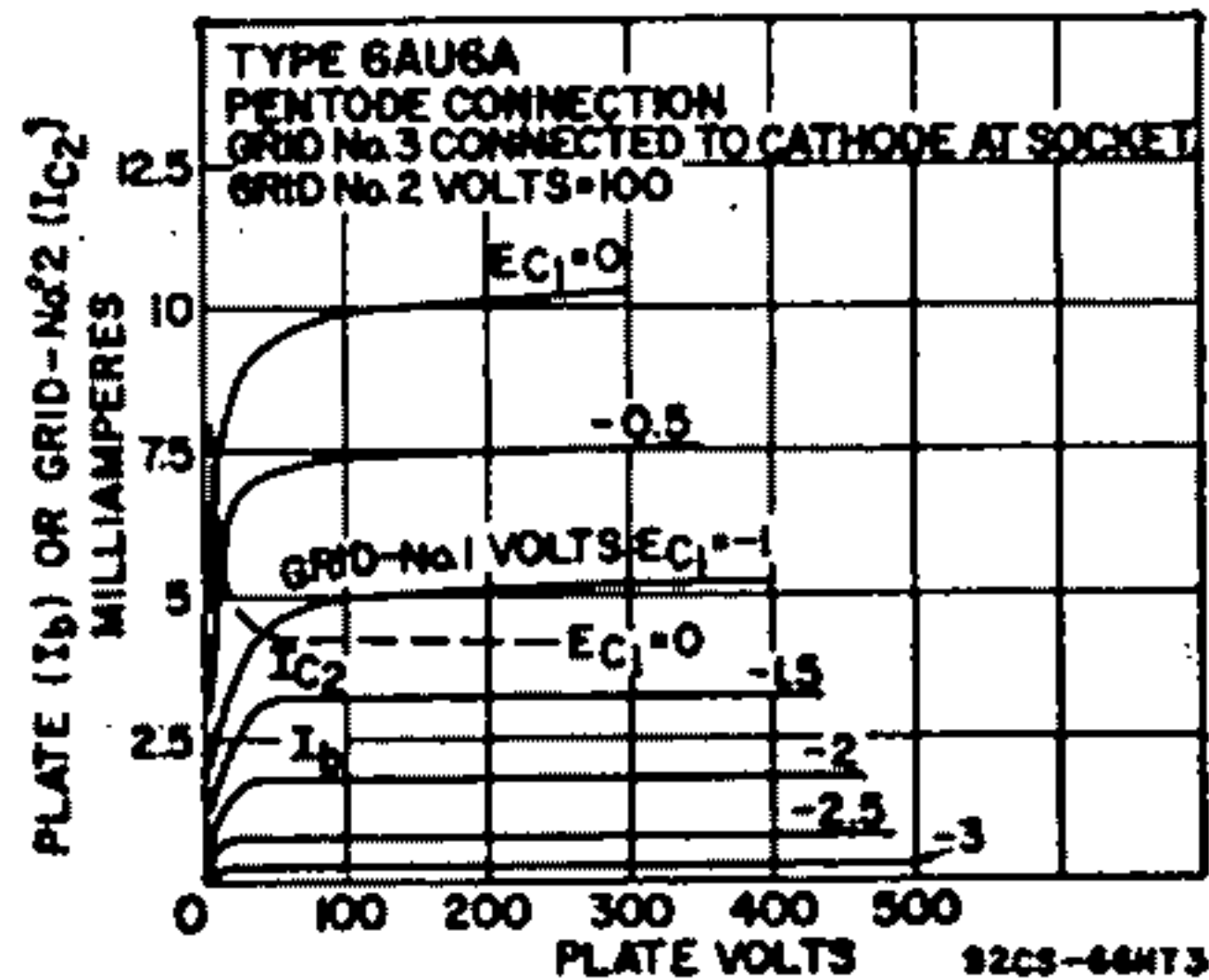
	3AU6	4AU6	6AU6	12AU6	
Heater Voltage (ac/dc) .....	3.15	4.2	6.3	12.6	volts
Heater Current .....	0.6	0.45	0.3	0.15	ampere
Heater Warm-up Time (Average) .....	11	11	11	—	seconds
<b>Heater-Cathode Voltage:</b>					
Peak value .....	±200 max	±200 max	±200 max	±200 max	volts
Average value .....	100 max	100 max	100 max	100 max	volts
<b>Direct Interelectrode Capacitances:</b>					
<b>Pentode Connection:</b>					
Grid No.1 to Plate .....				0.0035 max	pF
Grid No.1 to Cathode, Heater, Grid No.2, Grid No.3, and Internal Shield .....				5.5	pF
Plate to Cathode, Heater, Grid No.2, Grid No.3, and Internal Shield .....				5.0	pF
<b>Triode Connection:†</b>					
Grid No.1 to Plate, Grid No.2, Grid No.3, and Internal Shield .....				2.6	pF
Grid No.1 to Cathode and Heater .....				3.2	pF
Plate, Grid No.2, Grid No.3, and Internal Shield to Cathode and Heater .....				1.2*	pF

† Grid No.2, grid No.3, and internal shield connected to plate.  
\* Value is 8.5 pF with external shield connected to cathode.

### Class A<sub>1</sub> Amplifier

#### MAXIMUM RATINGS (Design-Maximum Values)

	Triode† Connection	Pentode Connection	
Plate Voltage .....	275	330	volts
Grid-No.3 (Suppressor-Grid) Voltage, Positive value .....	—	0	volts
Grid-No.2 (Screen-Grid) Voltage .....	—	See curve page 96	
Grid-No.2 Supply Voltage .....	—	330	volts
Grid-No.1 (Control-Grid) Voltage, Positive-bias value .....	0	0	volts
Plate Dissipation .....	3.5	3.5	watts
Grid-No.2 Input:			
For grid-No.2 voltages up to 165 volts .....	—	0.75	watt
For grid-No.2 voltages between 165 and 330 volts .....	—	See curve page 96	



#### CHARACTERISTICS

	Triode† Connection	Pentode Connection	
Plate Supply Voltage .....	250	100	volts
Grid No.3 .....	—	Connected to cathode at socket	
Grid-No.2 Supply Voltage .....	—	125	volts

	Triode† Connection		Pentode Connection		
	330	150	100	68	
Cathode-Bias Resistor .....	330	150	100	68	ohms
Amplification Factor .....	36	—	—	—	
Plate Resistance (Approx.) .....	—	0.5	1.5	1.0	megohms
Transconductance .....	4800	3900	4500	5200	μmbos
Plate Current .....	12.2	5.0	7.6	10.6	mA
Grid-No.2 Current .....	—	2.1	3.0	4.3	mA
Grid-No.1 Voltage for plate current of 10 μA .....	—	—4.2	—5.5	—6.5	volts

† Grid No.2, grid No.3, and internal shield connected to plate.

Refer to chart at end of section.

**6AU7**

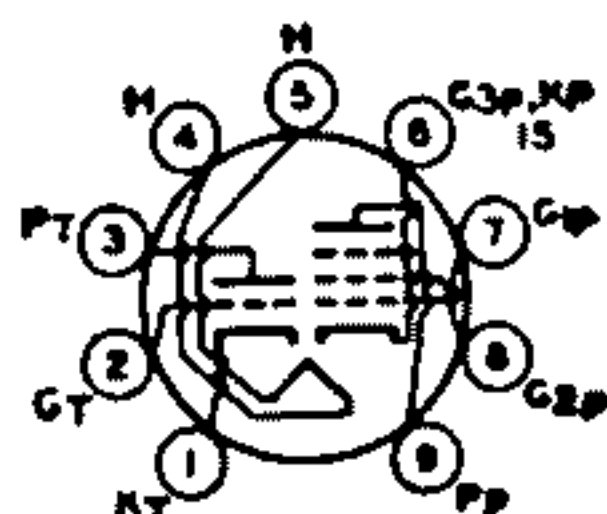
Refer to chart at end of section.

**6AU8**

**MEDIUM-MU TRIODE—  
SHARP-CUTOFF PENTODE**

**6AU8A**

8AU8



**9DX**

Miniature type used in television receiver applications. Pentode unit is used as video amplifier, if amplifier, and agc amplifier. Triode unit is used in sync-amplifier, sync-separator, sync-clipper, and phase-inverter circuits. Outlines section, 6E; requires 9-contact socket. Type 8AU8 is identical with type 6AU8A except for heater ratings.

	6AU8A	8AU8	
Heater Voltage (ac/dc) .....	6.3	8.4	volts
Heater Current .....	0.6	0.45	ampere
Heater Warm-up Time (Average) .....	11	—	seconds
Heater-Cathode Voltage:			
Peak value .....	±200 max	±200 max	volts
Average value .....	100 max	100 max	volts
Direct Interelectrode Capacitances:			
Triode Unit:			
Grid to Plate .....		2.2	pF
Grid to Cathode and Heater .....		2.6	pF
Plate to Cathode and Heater .....		0.84	pF
Pentode Unit:			
Grid No.1 to Plate .....		0.06	pF
Grid No.1 to Cathode, Heater, Grid No.2, Grid No.3, and Internal Shield .....		7.6	pF
Plate to Cathode, Heater, Grid No.2, Grid No.3, and Internal Shield .....		3.4	pF
Triode Grid to Pentode Plate .....		0.022 max	pF
Pentode Grid No.1 to Triode Plate .....		0.006 max	pF
Pentode Plate to Triode Plate .....		0.12 max	pF

**Class A<sub>1</sub> Amplifier**

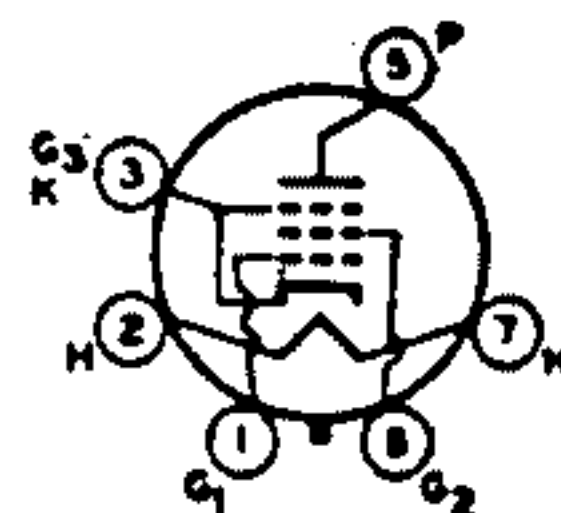
	Triode Unit	Pentode Unit	
<b>MAXIMUM RATINGS (Design-Maximum Values)</b>			
Plate Voltage .....	330	330	volts
Grid-No.2 (Screen-Grid) Supply Voltage .....	—	330	volts
Grid-No.2 Voltage .....	—	See curve page 96	
Grid-No.1 (Control-Grid) Voltage, Positive-bias value .....	0	0	volts
Plate Dissipation .....	2.8	3.3	watts
Grid-No.2 Input:			
For grid-No.2 voltages up to 165 volts .....	—	1	watt
For grid-No.2 voltages between 165 and 330 volts .....	—	See curve page 96	
<b>CHARACTERISTICS</b>			
Plate Supply Voltage .....	150	200	volts
Grid-No.2 Supply Voltage .....	—	125	volts
Cathode-Bias Resistor .....	150	82	ohms
Amplification Factor .....	43	—	
Plate Resistance (Approx.) .....	8100	100000	ohms
Transconductance .....	5300	8000	μmbos
Plate Current .....	9.5	17	mA
Grid-No.2 Current .....	—	8.4	mA
Grid-No.1 Voltage (Approx.) for plate current of 100 μA .....	—6.5	—7.5	volts
<b>MAXIMUM CIRCUIT VALUES</b>			
Grid-No.1-Circuit Resistance:			
For fixed-bias operation .....	0.5	0.25	megohm
For cathode-bias operation .....	1.0	1.0	megohm

# 6AV5GA

12AV5GA, 25AV5GA

## BEAM POWER TUBE

Glass octal type used as horizontal-deflection amplifier in television receivers. Outlines section, 19C; requires octal socket. Types 12AV5GA and 25AV5GA are identical with type 6AV5GA except for heater ratings.



6CK

	6AV5GA	12AV5GA	25AV5GA	
Heater Voltage (ac/dc)	6.3	12.6	25	volts
Heater Current	1.2	0.6	0.3	amperes
Heater Warm-up Time (Average)	—	11	—	seconds
<b>Heater-Cathode Voltage:</b>				
Peak value	±200 max	±200 max	±200 max	volts
Average value	100 max	100 max	100 max	volts
<b>Direct Interelectrode Capacitances (Approx.)</b>				
Grid No.1 to Plate	—	—	0.5	pF
Grid No.1 to Cathode, Heater, Grid No.2, and Grid No.3	—	—	14	pF
Plate to Cathode, Heater, Grid No.2, and Grid No.3	—	—	7.0	pF

### Class A<sub>1</sub> Amplifier

CHARACTERISTICS	Pentode Connection		Triode* Connection	
	60	250	150	
Plate Voltage	60	250	150	volts
Grid-No.2 (Screen-Grid) Voltage	150	150	150	volts
Grid-No.1 (Control-Grid) Voltage	0	-22.5	-22.5	volts
Plate Resistance	—	14500	—	ohms
Transconductance	—	5900	—	μmhos
Plate Current	260	67	—	mA
Screen Current	26	2.1	—	mA
Grid-No.1 Voltage (Approx.) for plate current of 1 mA	—	-43	—	volts
Amplification Factor	—	—	4.3	

\* Grid No.2 connected to plate.

### Horizontal-Deflection Amplifier

For operation in a 525-line, 30-frame system

#### MAXIMUM RATINGS (Design-Center Values)

DC Plate Voltage	550	volts
Peak Positive-Pulse Plate Voltage* (Absolute Maximum)	5500*	volts
Peak Negative-Pulse Plate Voltage	-1250	volts
DC Grid-No.2 Voltage	175	volts
Peak Negative-Pulse Grid-No.1 Voltage	-300	volts
Peak Cathode Current	400	mA
Average Cathode Current	110	mA
Grid-No.2 Input	2.5	watts
Plate Dissipation††	11	watts
Bulb Temperature (at hottest point)	210	°C

#### MAXIMUM CIRCUIT VALUE

Grid-No.1-Circuit Resistance	0.47	megohm
------------------------------	------	--------

\* Pulse duration must not exceed 15% of a horizontal scanning cycle (10 microseconds).

\* Under no circumstances should this absolute value be exceeded.

†† A bias resistor or other means is required to protect the tube in absence of excitation.

## 6AV5GT

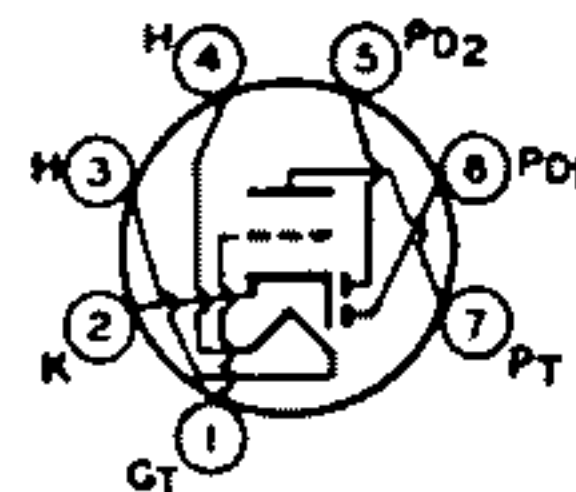
Refer to chart at end of section.

# 6AV6

3AV6, 4AV6, 12AV6

## TWIN DIODE— HIGH-MU TRIODE

Miniature type used as combined detector, amplifier, and avc tube in automobile and ac-operated radio receivers. The 6AV6 may be substituted directly for the 6AT6 in applications where the higher amplification of the 6AV6 is advantageous. Outlines section, 5C; requires miniature 7-contact socket. Types 3AV6, 4AV6, and 12AV6 are identical with type 6AV6 except for heater ratings.



7BT



	3AV6	4AV6	6AV6	12AV6	
Heater Voltage (ac/dc) .....	8.15	4.2	6.3	12.6	volts
Heater Current .....	0.6	0.45	0.3	0.15	ampere
Heater Warm-up Time (Average) .....	11	11	—	—	seconds
<b>Heater-Cathode Voltage:</b>					
Peak value .....	±200 max	±200 max	±200 max	±200 max	volts
Average value .....	100 max	100 max	100 max	100 max	volts
<b>Direct Interelectrode Capacitances:</b>					
Triode Grid to Triode Plate .....				2.0	pF
Triode Grid to Cathode and Heater .....				2.2	pF
Triode Plate to Cathode and Heater .....				0.8*	pF
Plate of Diode Unit No.2 to Triode Grid .....				0.04 max	pF

\* This value is 1.2 pF with external shield connected to cathode.

**Triode Unit as Class A<sub>1</sub> Amplifier**

**MAXIMUM RATING (Design-Maximum Value)**

Plate Voltage .....	330	volts
Grid Voltage, Positive-bias value .....	0	volts
Plate Dissipation .....	0.55	watt

**CHARACTERISTICS**

Plate Voltage .....	100	250	volts
Grid Voltage .....	-1	-2	volts
Amplification Factor .....	100	100	
Plate Resistance .....	80000	62500	ohms
Transconductance .....	1250	1600	μmhos
Plate Current .....	0.50	1.2	mA

**Diode Units**

**MAXIMUM RATING (Design-Maximum Value)**

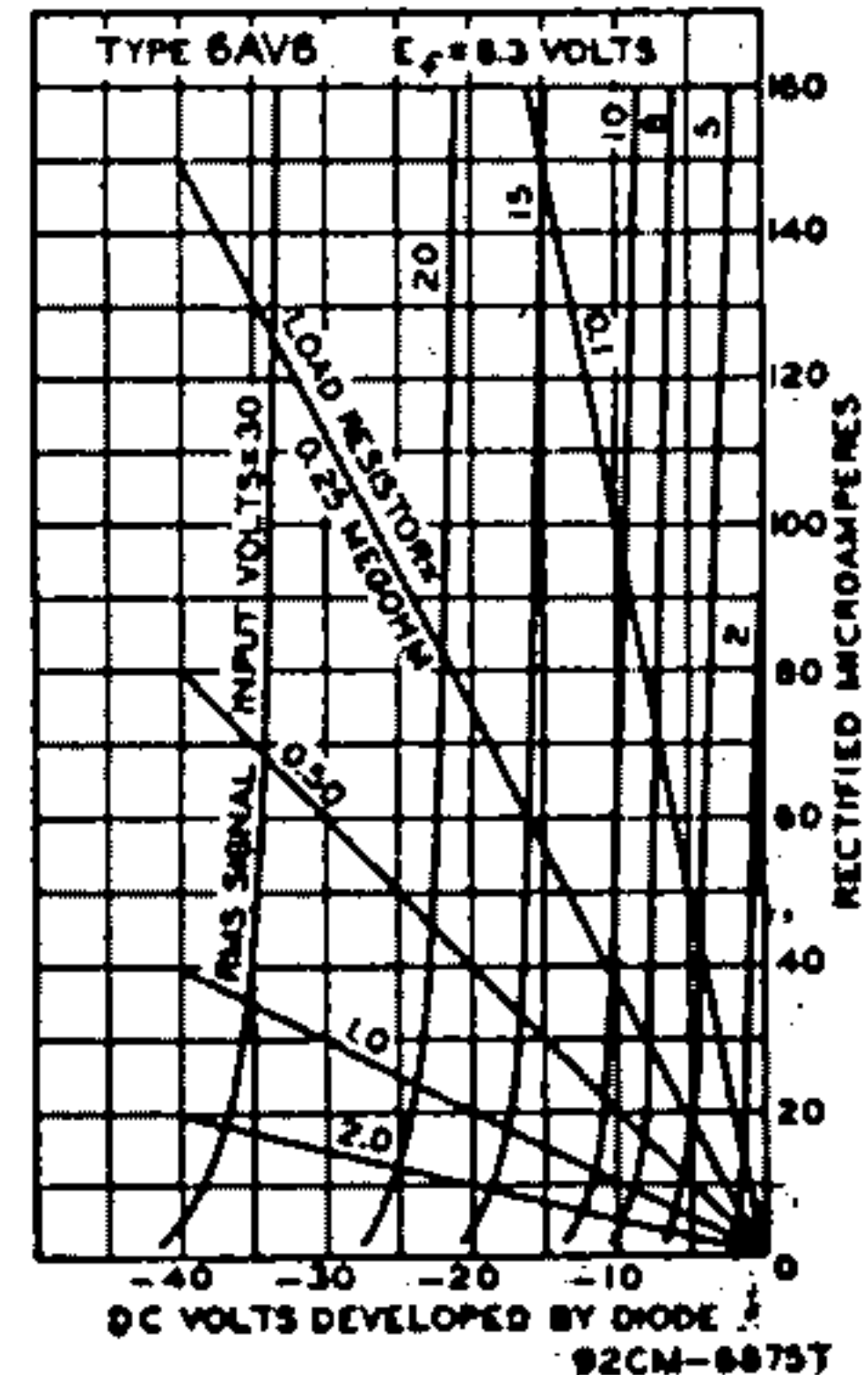
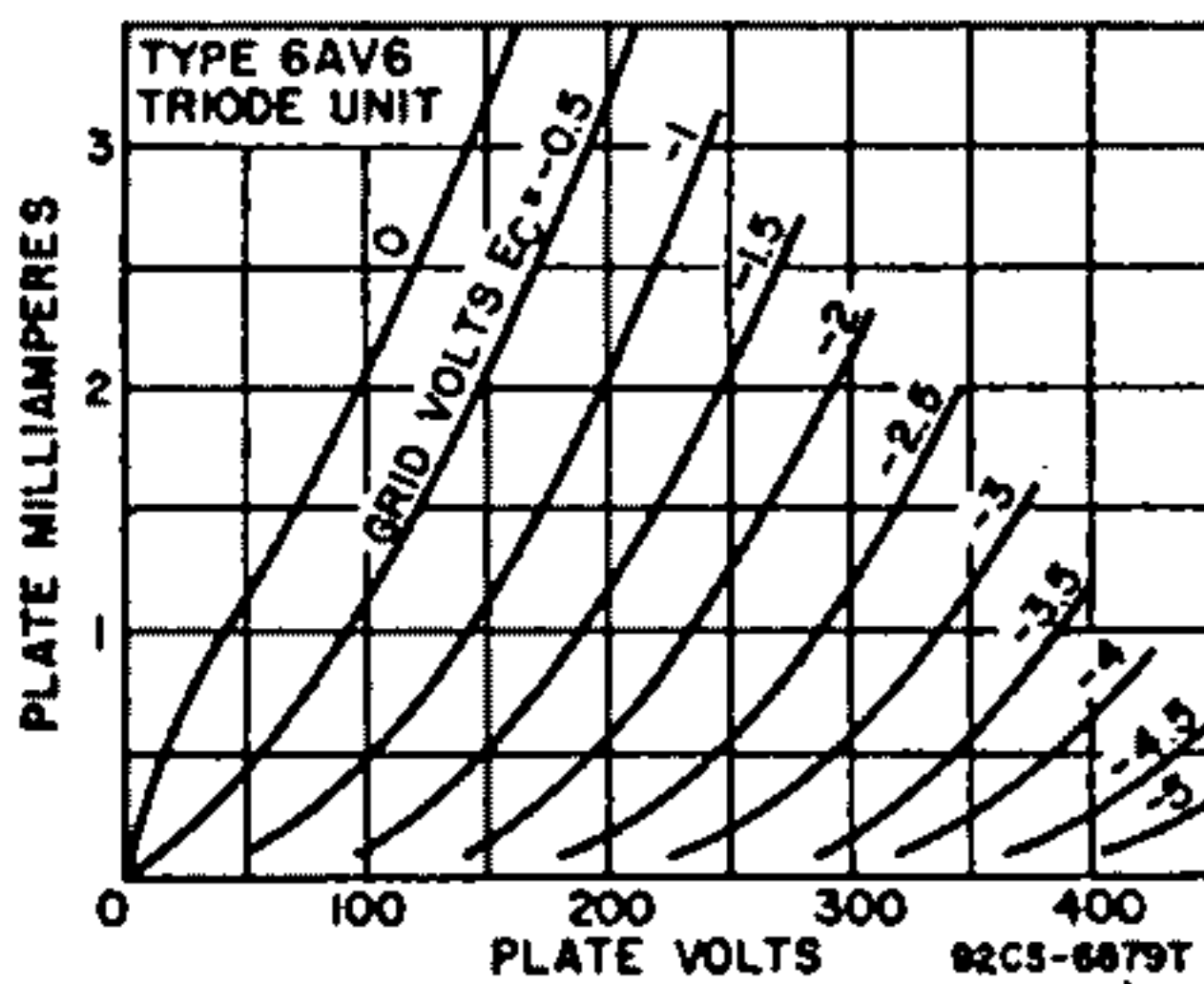
Plate Current (Each Unit) .....	1.0	mA
---------------------------------	-----	----

The two diode plates are placed around a cathode, the sleeve of which is common to the triode unit. Each diode plate has its own base pin. Diode biasing of the triode unit is not recommended.

**Installation and Application**

The triode unit of the 6AV6 is recommended for use only in resistance-coupled circuits. Refer to the Resistance-Coupled Amplifier section for typical operating conditions. Grid bias for the triode unit of the 6AV6 may be obtained from a fixed source, such as a fixed-voltage tap on the dc power supply, or from a cathode-bias resistor. It should not be obtained by the diode-biasing method because of the probability of plate-current cutoff, even with relatively small signal voltages applied to the diode circuit.

**AVERAGE DIODE CHARACTERISTICS  
HALF-WAVE RECTIFICATION-SINGLE DIODE UNIT**



Refer to chart at end of section.

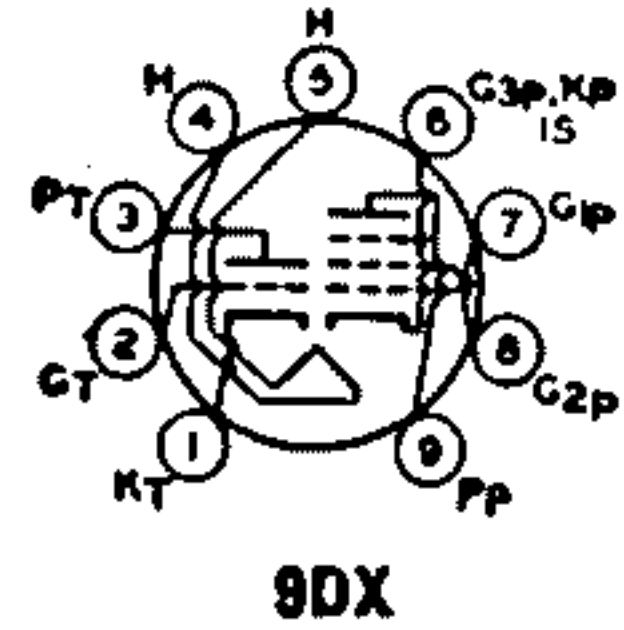
**6AW8**

# 6AW8A

8AW8A

## HIGH-MU TRIODE— SHARP-CUTOFF PENTODE

Miniature type used in television receiver applications. The pentode unit is used as an if amplifier, video amplifier, agc amplifier, or reactance tube. The triode unit is used in low-frequency oscillator, sync-separator, sync-clipper, and phase-splitter circuits. Outlines section, 6E; requires miniature 9-contact socket. Type 8AW8A is identical with type 6AW8A except for heater ratings.



Heater Voltage (ac/dc) .....	6.3	8.4	volts
Heater Current .....	0.6	0.45	ampere
Heater Warm-up Time (Average) .....	11	11	seconds
Heater-Cathode Voltage:			
Peak value .....	±200 max	±200 max	volts
Average value .....	100 max	100 max	volts

	6AW8A	8AW8A	
Direct Interelectrode Capacitances:			
Triode Unit:			
Grid to Plate .....	2.2	2.2	pF
Grid to Cathode, Pentode Cathode, Pentode Grid No.3, Internal Shield, and Heater ....	3.2	3.4	pF
Plate to Cathode, Pentode Cathode, Pentode Grid No.3, Internal Shield, and Heater ....	1.8	3.0	pF
Pentode Unit:			
Grid No.1 to Plate .....	0.06 max	0.05 max	pF
Grid No.1 to Cathode, Heater, Grid No.2, Grid No.3, and Internal Shield .....	10	10	pF
Plate to Cathode, Heater, Grid No.2, Grid No.3, and Internal Shield .....	3.6	4.5	pF
Pentode Grid No.1 to Triode Plate .....	0.008 max	0.005 max	pF
Pentode Plate to Triode Plate .....	0.15 max	0.025 max	pF

\* With external shield connected to pins 4 and 5.

### Class A<sub>1</sub> Amplifier

#### MAXIMUM RATINGS (Design-Maximum Values)

Plate Voltage .....	330	330	volts
Grid-No.2 (Screen-Grid) Supply Voltage .....	—	330	volts
Grid-No.2 Voltage .....	—	See curve page 96	
Grid-No.1 (Control-Grid) Voltage, positive-bias value .....	0	0	volts
Plate Dissipation .....	1.1	3.75	watts
Grid-No.2 Input:			
For grid-No.2 voltages up to 165 volts .....	—	1.1	watts
For grid-No.2 voltages between 165 and 330 volts .....	—	See curve page 96	

	Triode Unit	Pentode Unit	
Plate Voltage .....	330	330	volts
Grid-No.2 (Screen-Grid) Supply Voltage .....	—	330	volts
Grid-No.2 Voltage .....	—	See curve page 96	
Grid-No.1 (Control-Grid) Voltage, positive-bias value .....	0	0	volts
Plate Dissipation .....	1.1	3.75	watts
Grid-No.2 Input:			
For grid-No.2 voltages up to 165 volts .....	—	1.1	watts
For grid-No.2 voltages between 165 and 330 volts .....	—	See curve page 96	

#### CHARACTERISTICS

Plate Supply Voltage .....	200	150	volts
Grid-No.2 Supply Voltage .....	—	150	volts
Grid-No.1 Voltage .....	—2	—	volts
Cathode-Bias Resistor .....	—	150	ohms
Amplification Factor .....	70	—	

	Triode Unit	Pentode Unit	
Plate Supply Voltage .....	200	150	volts
Grid-No.2 Supply Voltage .....	—	150	volts
Grid-No.1 Voltage .....	—2	—	volts
Cathode-Bias Resistor .....	—	150	ohms
Amplification Factor .....	70	—	

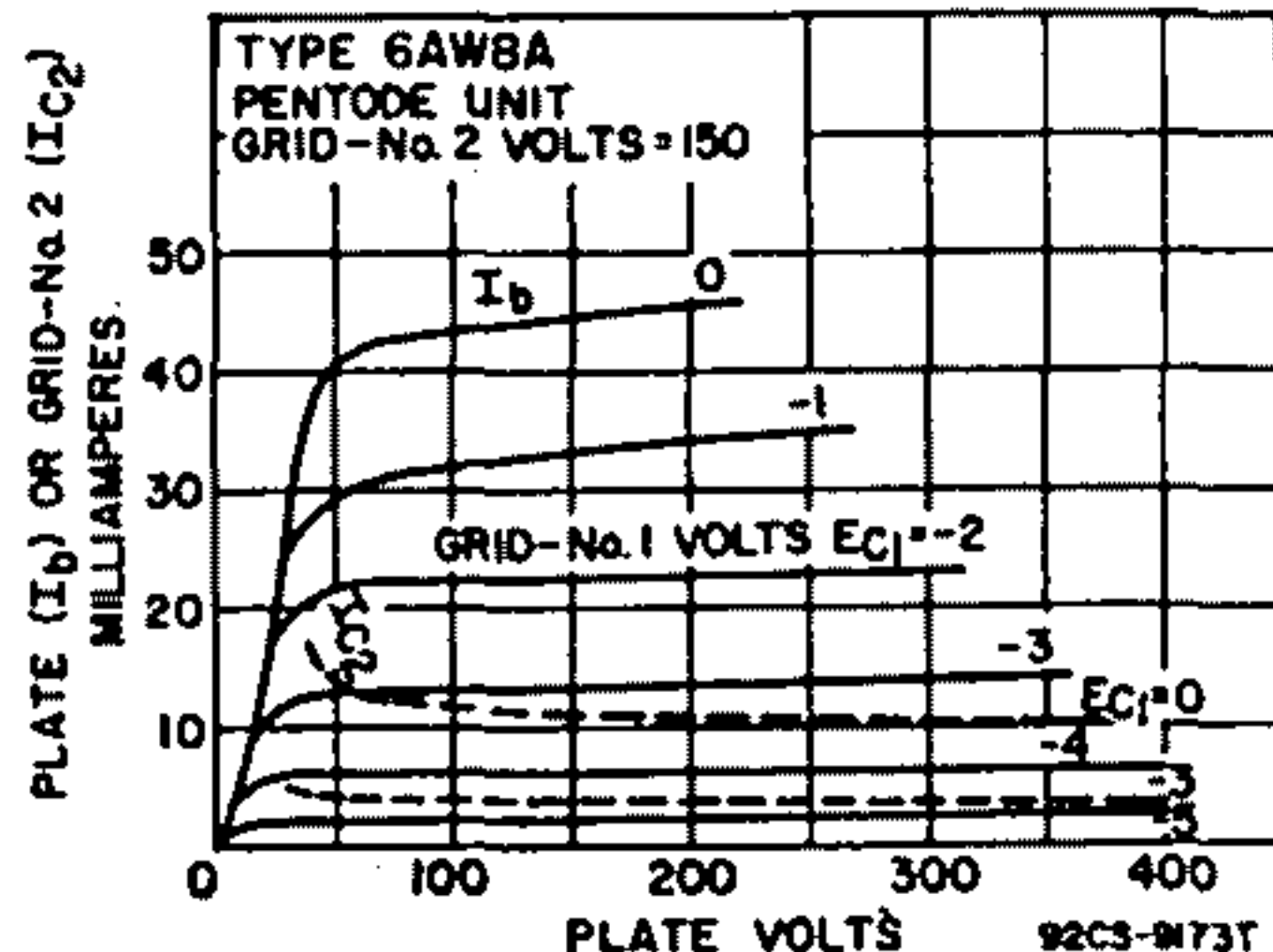
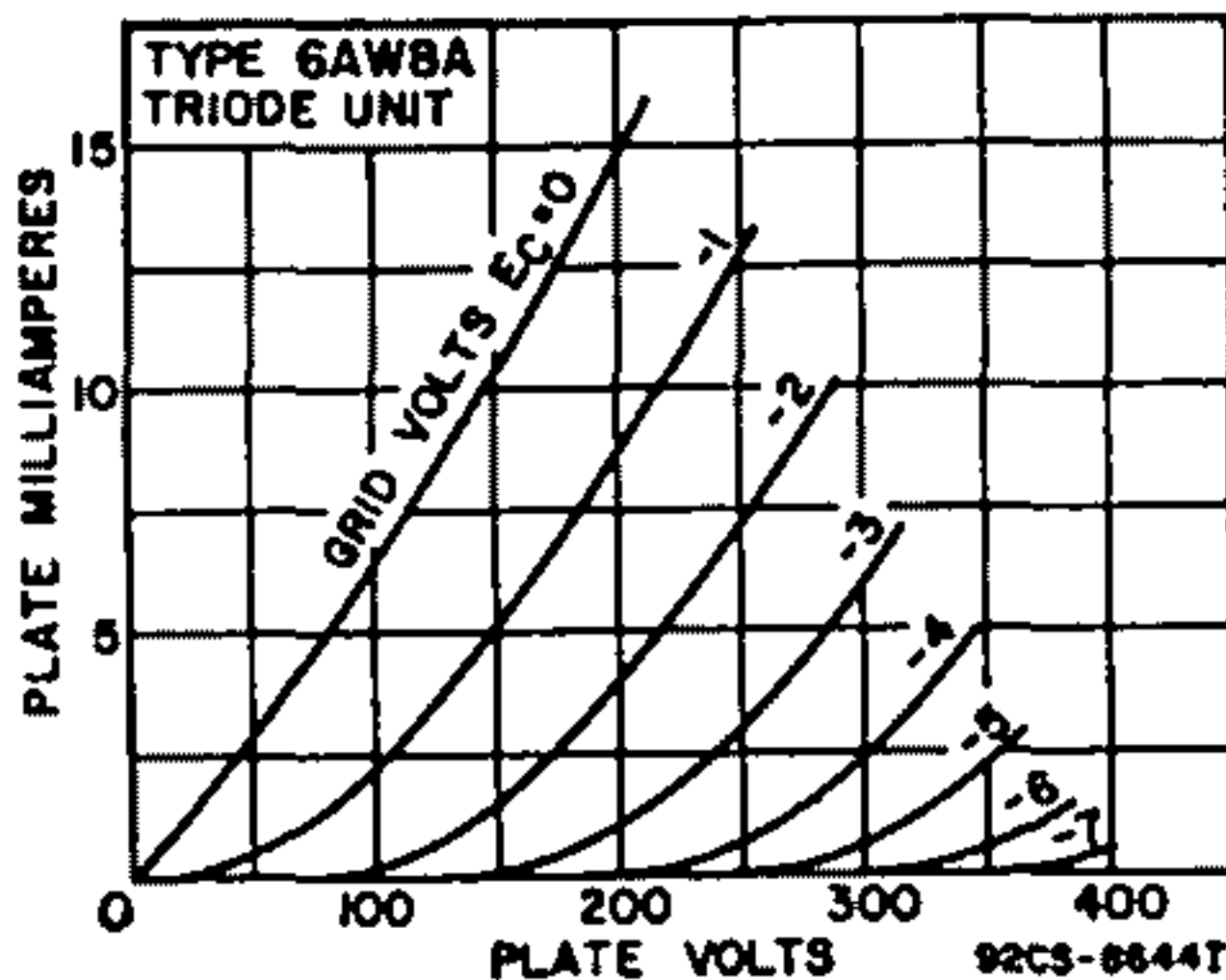
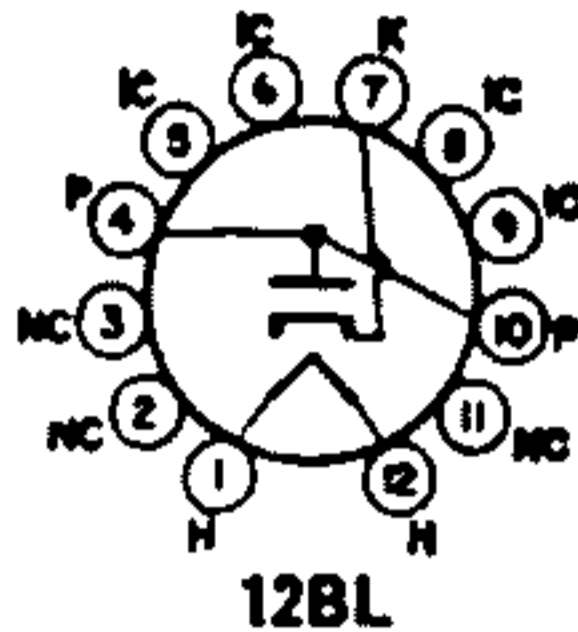


Plate Resistance (Approx.) .....	—	0.2	megohm
Transconductance .....	4000	9500	μmhos
Plate Current .....	4	15	mA
Grid-No.2 Current .....	—	3.5	mA
Grid-No.1 Voltage (Approx.) for plate current of 20 μA .....	—5	—8	volts

**MAXIMUM CIRCUIT VALUES**

Grid-No.1-Circuit Resistance:			
For fixed-bias operation .....	0.5	0.25	megohm
For cathode-bias operation .....	1.0	1.0	megohm



12BL

**HALF-WAVE VACUUM RECTIFIER**

**6AX3**

12AX3, 17AX3

Duodecar type used as damper tube in horizontal-deflection circuits of television receivers. Outlines section, 8C; requires 12-contact socket. Socket terminals 5, 6, 8, and 9 should not be used as tie points. This tube, like other power-handling tubes, should be adequately ventilated. Types 12AX3 and 17AX3 are identical with type 6AX3 except for heater ratings.

Heater Voltage (ac/dc) .....	6AX3	12AX3	17AX3	
Heater Current .....	6.3	12.6	16.8	volts
Heater Warm-up Time (Average) .....	1.2	0.6	0.45	amperes
Heater Warm-up Time (Average) .....	—	11	11	seconds
Direct Interelectrode Capacitances:				
Plate to Cathode and Heater .....			5.5	pF
Cathode to Plate and Heater .....			7.5	pF
Heater to Cathode .....			2.8	pF

**Damper Service**

For operation in a 525-line, 30-frame system

**MAXIMUM RATINGS (Design-Maximum Values)**

Peak Inverse Plate Voltage# .....		5000	volts
Peak Plate Current .....		1000	mA
Average Plate Current .....		165	mA
Plate Dissipation .....		5.3	watts
Heater-Cathode Voltage:			
Peak value .....	+300	—5000	volts
Average value .....	+100	—900	volts

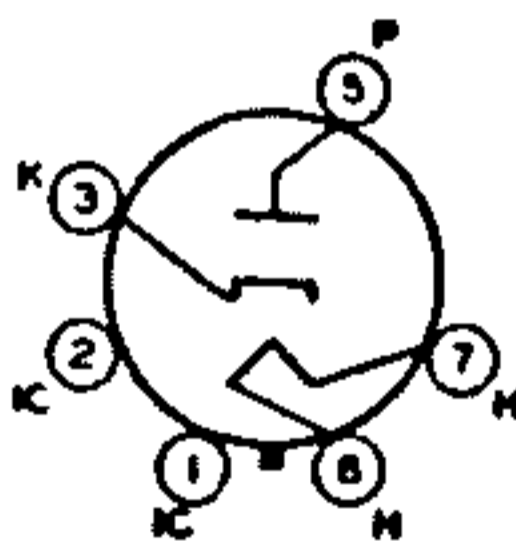
**CHARACTERISTICS**

Tube Voltage Drop for plate current of 250 mA .....		32	volts
---	--	----	-------

# Pulse duration must not exceed 15% of a horizontal scanning cycle (10 microseconds).

Refer to chart at end of section.

**6AX4GT**



4CG

**HALF-WAVE VACUUM RECTIFIER**

**6AX4GTB**

12AX4GTB, 17AX4GTA, 25AX4GT

Glass octal type used as damper tube in horizontal-deflection circuits of color and black-and-white television receivers. Outlines section, 13D; requires octal socket. May be supplied with pin No. 1 omitted. Socket terminals 1, 2, 4, and 6 should not be used as tie points. This tube, like other power-handling tubes, should be adequately ventilated. Types 12AX4/GTB, 17AX4GTA, and 25AX4GT are identical with type 6AX4GTB except for heater ratings.

Heater Voltage (ac/dc) .....	6AX4-GTB	12AX4-GTB	17AX4-GTA	25AX4GT	
Heater Current .....	6.3	12.6	16.8	25	volts
Heater Warm-up Time (Average) .....	1.2	0.6	0.45	0.3	amperes
Heater Warm-up Time (Average) .....	—	11	11	11	seconds
Direct Interelectrode Capacitances (Approx.):					
Cathode to Plate and Heater .....				8.5	pF
Plate to Cathode and Heater .....				5	pF
Heater to Cathode .....				4	pF



**Damper Service**

For operation in a 525-line, 30-frame system

**MAXIMUM RATINGS (Design-Maximum Values)**

Peak Inverse Plate Voltage#	5000	volts
Peak Plate Current	1000	mA
Average Plate Current	165	mA
Plate Dissipation	5.3	watts
<b>Heater-Cathode Voltage:</b>		
Peak value	+300      -5000	volts
Average value	+100      -900	volts

**CHARACTERISTICS, Instantaneous Value**

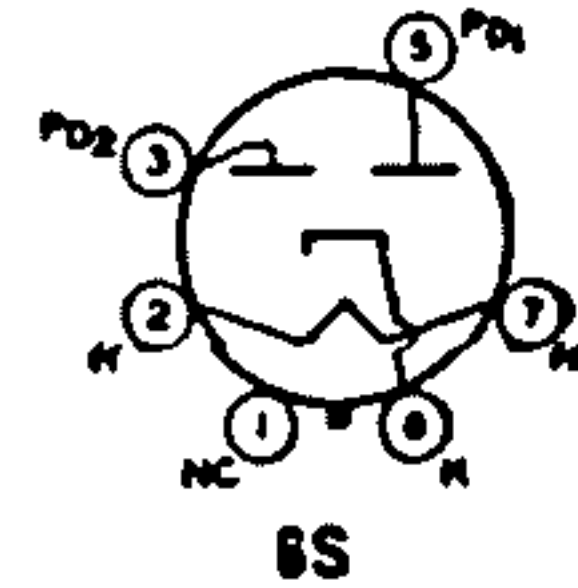
Tube Voltage Drop for plate current of 250 mA	82	volts
---	----	-------

# Pulse duration must not exceed 15% of a horizontal scanning cycle (10 microseconds).

**6AX5GT**

**FULL-WAVE VACUUM RECTIFIER**

Glass octal type used in power supplies of radio equipment having moderate dc requirements. Outlines section, 13D; requires octal socket. This type may be supplied with pin No. 1 omitted. This tube, like other power-handling tubes, should be adequately ventilated. Heater: volts (ac), 6.3; amperes, 1.2.



**Full-Wave Rectifier**

**MAXIMUM RATINGS (Design-Center Values)**

Peak Inverse Plate Voltage	1250	volts
Peak Plate Current (Per Plate)	375	mA
Hot-Switching Transient Plate Current:		
For duration of 0.2 second maximum	2.6	ampere
AC Plate Supply Voltage (Per Plate, rms)	See Rating Chart	
Average Output Current (Per Plate, rms)	See Rating Chart	
Peak Heater-Cathode Voltage	±450	volts

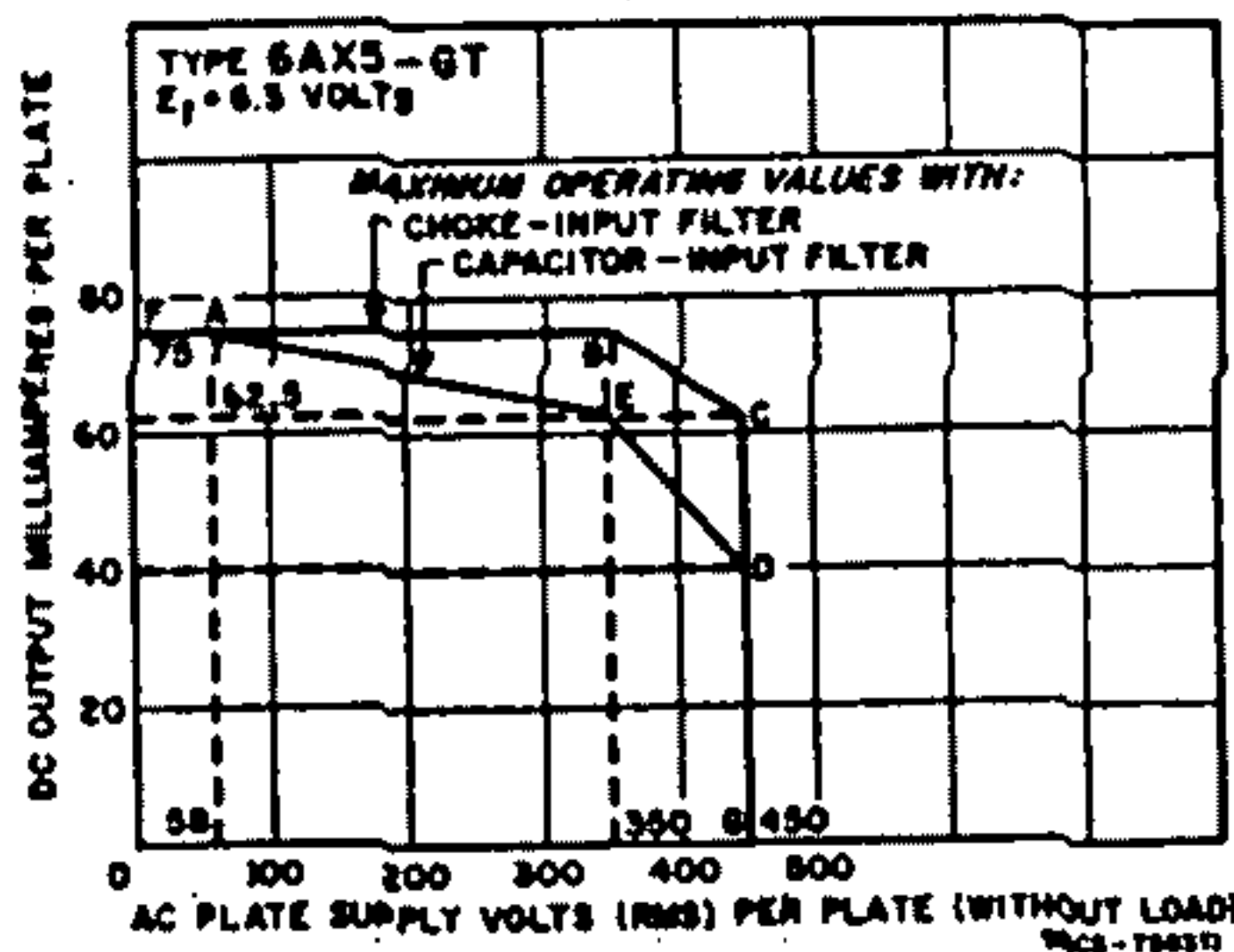
**TYPICAL OPERATION WITH CAPACITOR INPUT TO FILTER**

AC Plate-to-Plate Supply Voltage (rms)	700	900	volts	
Filter Input Capacitor*	10	10	μF	
Effective Plate-Supply Impedance Per Plate	50	105	ohms	
<b>DC Output Voltage at Input to Filter (Approx.):</b>				
At half-load current of	62.5 mA	395	volts	
	40 mA	—	540	volts
At full-load current of	125 mA	350	volts	
	80 mA	—	490	volts
<b>Voltage Regulation (Approx.):</b>				
Half-load to full-load current	45	50	volts	

**TYPICAL OPERATION WITH CHOKE INPUT TO FILTER**

AC Plate-to-Plate Supply Voltage (rms)	700	900	volts	
Filter Input Choke	10#	10##	henries	
<b>DC Output Voltage at Input to Filter (Approx.):</b>				
At half-load current of	75 mA	270	volts	
	62.5 mA	—	365	volts
At full-load current of	150 mA	250	volts	
	125 mA	—	350	volts

**RATING CHART**



Voltage Regulation (Approx.):

Half-load to full-load current .....	20	15	volts
--------------------------------------	----	----	-------

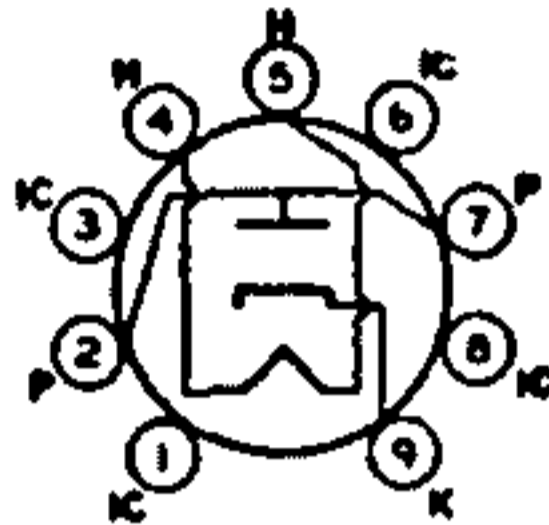
\* Higher values of capacitance than indicated may be used but the effective plate-supply impedance may have to be increased to prevent exceeding the maximum rating for hot-switching transient plate current.

# This value is adequate to maintain optimum regulation provided the load current is not less than 30 mA. For load currents less than 30 mA, a larger value of inductance is required for optimum regulation.

## This value is adequate to maintain optimum regulation provided the load current is not less than 35 mA. For load currents less than 35 mA, a larger value of inductance is required for optimum regulation.

Refer to chart at end of section.

6AX8



9HP

**HALF-WAVE  
VACUUM RECTIFIER**

**6AY3  
6AY3B**

12AY3, 12AY3A,  
17AY3, 17AY3A

Novar types used as damper tubes in horizontal-deflection circuits of black-and-white television receivers.

Outlines section, 11D and 30B, respectively; require novar 9-contact socket. Socket terminals 1, 3, 6, and 8 should not be used as tie points. It is especially important that these tubes, like other power-handling tubes, be adequately ventilated. Types 12AY3 and 12AY3A and types 17AY3 and 17AY3A are identical with types 6AY3 and 6AY3B except for heater ratings.

	6AY3 6AY3B	12AY3 12AY3A	17AY3 17AY3A	
Heater Voltage (ac/dc) .....	6.8	12.6	16.8	volts
Heater Current .....	1.2	0.6	0.45	amperes
Heater Warm-up Time (Average) .....	—	11	11	seconds
Direct Interelectrode Capacitances (Approx.):				
Plate to Cathode and Heater .....			6.5	pF
Cathode to Plate and Heater .....			9.0	pF
Heater to Cathode .....			2.8	pF

**Damper Service**

For operation in a 525-line, 30-frame system

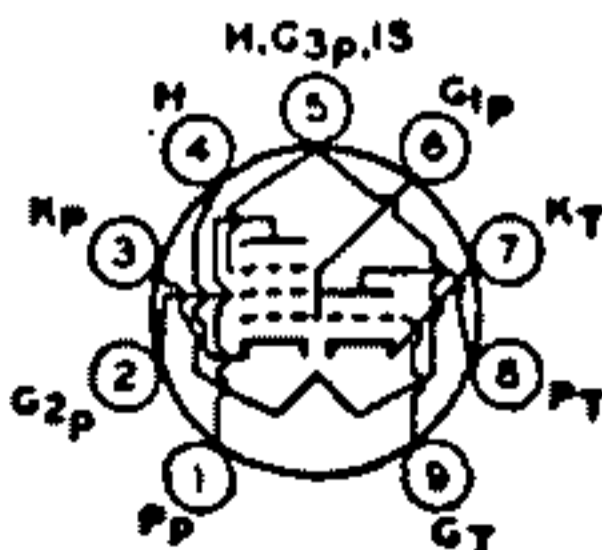
**MAXIMUM RATINGS (Design-Maximum Values)**

Peak Inverse Plate Voltage# .....	5000	volts	
Peak Plate Current .....	1100	mA	
Average Plate Current .....	175	mA	
Plate Dissipation .....	6.5	watts	
Heater-Cathode Voltage:			
Peak value .....	+300	—5000	volts
Average value .....	+100	—900	volts

# Pulse duration must not exceed 15% of a horizontal scanning cycle (10 microseconds).

Refer to chart at end of section.

6AY11



9ED

**MEDIUM-MU TRIODE—  
SHARP-CUTOFF PENTODE**

**6AZ8**

Miniature type used in color and black-and-white television receiver applications. The pentode unit is used as an if amplifier, video amplifier, agc amplifier, or reactance tube. The triode unit is used in low-frequency oscillator, sync-separator, sync-clipper, and phase-splitter circuits. Outlines section, 6B; requires miniature 9-contact socket.

Heater Voltage (ac/dc) .....	6.8	volts
Heater Current .....	0.45	ampere
Heater-Cathode Voltage: <sup>A</sup>		
Peak value .....	±200 max	volts
Average value .....	100 max	volts

Direct Interelectrode Capacitances:

Triode Unit:		
Grid to Plate .....	1.7	pF
Grid to Cathode, Heater, Pentode Grid No.3, and Internal Shield .....	2	pF
Plate to Cathode, Heater, Pentode Grid No.3, and Internal Shield .....	1.7	pF
Pentode Unit:		
Grid No.1 to Plate .....	0.02 max	pF
Grid No.1 to Cathode, Heater, Grid No.2, Grid No.3, and Internal Shield .....	6.6	pF
Plate to Cathode, Heater, Grid No.2, Grid No.3, and Internal Shield .....	2.2	pF
Triode Grid to Pentode Plate .....	0.027 max	pF
Pentode Grid No.1 to Triode Plate .....	0.020 max	pF
Pentode Plate to Triode Plate .....	0.045 max	pF

\* The heater-cathode voltage of the pentode unit should not exceed the value of the operating cathode bias. Grid No.3 will be made negative with respect to cathode if this value is exceeded, and thus possibly cause a change in tube characteristics.

**Class A<sub>1</sub> Amplifier**

MAXIMUM RATINGS (Design-Center Values)	Triode Unit	Pentode Unit	
Plate Voltage .....	300	300	volts
Grid-No.2 (Screen-Grid) Supply Voltage .....	—	300	volts
Grid-No.2 Voltage .....	See curve page 96		
Grid-No.1 (Control-Grid) Voltage, Positive-bias value .....	0	0	volts
Plate Dissipation .....	2.6	2	watts
Grid-No.2 Input:			
For grid-No.2 voltages up to 150 volts .....	—	0.5	watt
For grid-No.2 voltages between 150 and 300 volts .....	See curve page 96		
<b>CHARACTERISTICS</b>			
Plate Supply Voltage .....	200	200	volts
Grid-No.2 Voltage .....	—	150	volts
Grid-No.1 Voltage .....	—6	—	volts
Cathode-Bias Resistor .....	—	180	ohms
Amplification Factor .....	19	—	
Plate Resistance (Approx.) .....	5750	300000	ohms
Transconductance .....	3300	6000	μmhos
Plate Current .....	13	9.5	mA
Grid-No.2 Current .....	—	3	mA
Grid-No.1 Voltage (Approx.) for plate current of 10 μA .....	—19	—	volts
Grid-No.1 Voltage (Approx.) for transconductance of 100 μmhos .....	—	—12.5	volts
<b>MAXIMUM CIRCUIT VALUES</b>			
Grid-No.1-Circuit Resistance:*			
For fixed-bias operation .....	0.5	0.25	megohm
For cathode-bias operation .....	1.0	1.0	megohm

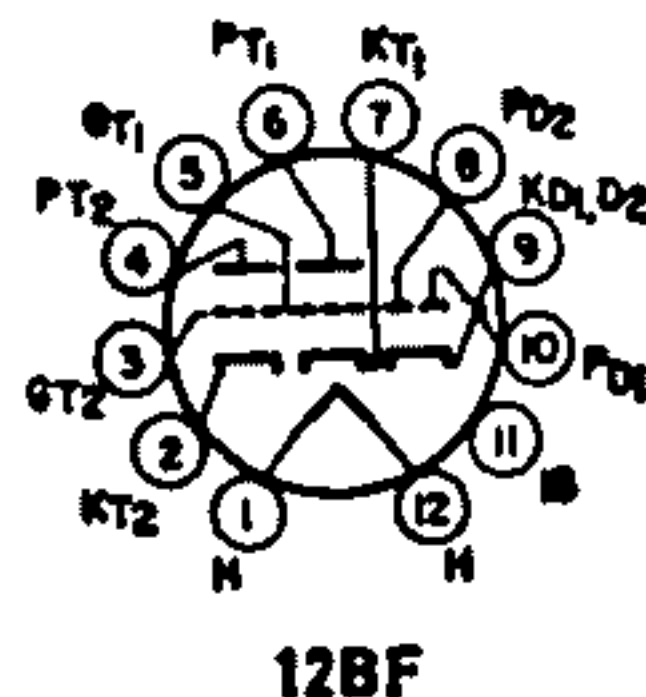
\* If either unit is operating at maximum rated conditions, grid-No.1-circuit resistance for both units should not exceed the stated values.

- 6B4G** Refer to chart at end of section.
- 6B5** Refer to chart at end of section.
- 6B6G** Refer to chart at end of section.
- 6B7** Refer to chart at end of section.
- 6B7S** Refer to chart at end of section.
- 6B8** Refer to chart at end of section.
- 6B8G** Refer to chart at end of section.

**6B10**  
8B10

**TWIN DIODE—  
MEDIUM-MU TWIN TRIODE**

Duodecar type used in television receiver applications; diode units are used in horizontal-phase-detector circuits, and triode units are used in horizontal-oscillator circuits. Outlines section, 8A; requires duodecar 12-contact socket. Type 8B10 is identical with type 6B10 except for heater ratings.





	<b>6B10</b>	<b>8B10</b>	
Heater Voltage (ac/dc) .....	6.3	8.5	volts
Heater Current .....	0.6	0.45	ampere
Heater Warm-up Time (Average) .....	11	11	seconds
Heater-Cathode Voltage:			
Peak value .....	±200 max	±200 max	volts
Average value .....	100 max	100 max	volts

**Class A<sub>1</sub> Amplifier (Each Triode Unit)**

<b>MAXIMUM RATING (Design-Maximum Value)</b>			
Plate Voltage .....	330		volts
Average Cathode Current .....	20		mA
Plate Dissipation .....	3		watts

**CHARACTERISTICS**

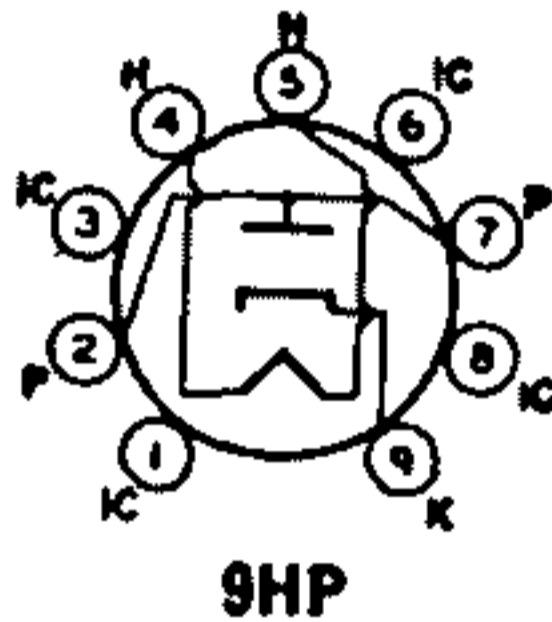
Plate Voltage .....	250		volts
Grid Voltage .....	-8		volts
Amplification Factor .....	18		
Plate Resistance (Approx.) .....	7200		ohms
Transconductance .....	2500		μmhos
Plate Current .....	10		mA
Grid Voltage (Approx.) for plate current of 50 μA .....	-20		volts

**MAXIMUM CIRCUIT VALUES**

<b>Grid-Circuit Resistance:</b>			
For fixed-bias operation .....	0.25		megohm
For cathode-bias operation .....	1		megohm

**Diode Units (Each Unit)**

<b>MAXIMUM RATING (Design-Maximum Value)</b>			
Plate Current .....	5		mA
<b>CHARACTERISTICS, Instantaneous Value</b>			
Tube Voltage Drop for plate current of 20 mA .....	5		volts



**HALF-WAVE VACUUM RECTIFIER**

**6BA3**

Novar type used as damper tube in horizontal-deflection circuits of black-and-white television receivers. Outlines section, 11B or 30C; requires novar 9-contact socket. Socket terminals 1, 3, 6, and 8 should not be used as tie points. This tube, like other power-handling tubes, should be adequately ventilated.

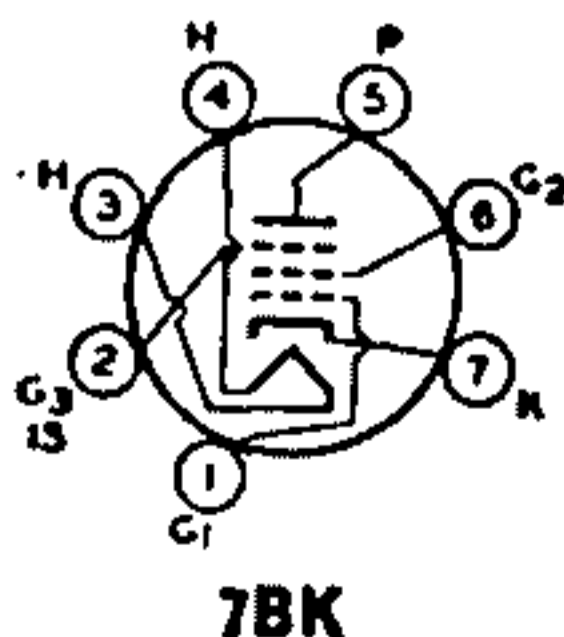
Heater Voltage (ac/dc) .....	6.3		volts
Heater Current .....	1.2		amperes
<b>Direct Interelectrode Capacitances (Approx.):</b>			
Plate to Cathode and Heater .....	4.4		pF
Cathode to Plate and Heater .....	6		pF
Heater to Cathode .....	1.8		pF

**Damper Service**

For operation in a 525-line, 30-frame system

<b>MAXIMUM RATINGS (Design-Maximum Values)</b>			
Peak Inverse Plate Voltage# .....	5000		volts
Peak Plate Current .....	1000		mA
Average Plate Current .....	165		mA
Plate Dissipation .....	5.3		watts
<b>Heater-Cathode Voltage:</b>			
Peak value .....	+300	-5000	volts
Average value .....	+100	-900	volts

# Pulse duration must not exceed 15% of a horizontal scanning cycle (10 microseconds).



**REMOTE-CUTOFF PENTODE**

**6BA6**  
**6BA6/EF93**  
3BA6, 12BA6

Miniature types used as rf amplifiers in standard broadcast and FM receivers, as well as in wide-band, high-

frequency applications. The low value of grid-No.1-to-plate capacitance minimizes regenerative effects, while the high transconductance makes possible high signal-to-noise ratio. Outlines section, 5C; require miniature 7-contact socket. Types 3BA6 and 12BA6 are identical with type 6BA6 except for heater ratings.

	3BA6	6BA6	12BA6	
Heater Voltage (ac/dc)	8.15	6BA6/EF93 6.8	12.6	volts
Heater Current	0.6	0.8	0.15	ampere
Heater Warm-up Time (Average)	11	—	—	seconds
<b>Heater-Cathode Voltage:</b>				
Peak value	±200 max	±200 max	±200 max	volts
Average value	100 max	100 max	100 max	volts
<b>Direct Interelectrode Capacitances:</b>				
Grid No.1 to Plate			0.0035 max	pF
Grid No.1 to Cathode, Heater, Grid No.2, Grid No.3, and Internal Shield			6.5	pF
Plate to Cathode, Heater, Grid No.2, Grid No.3, and Internal Shield			5*	pF

\* This value is 5.5 pF with external shield connected to cathode.

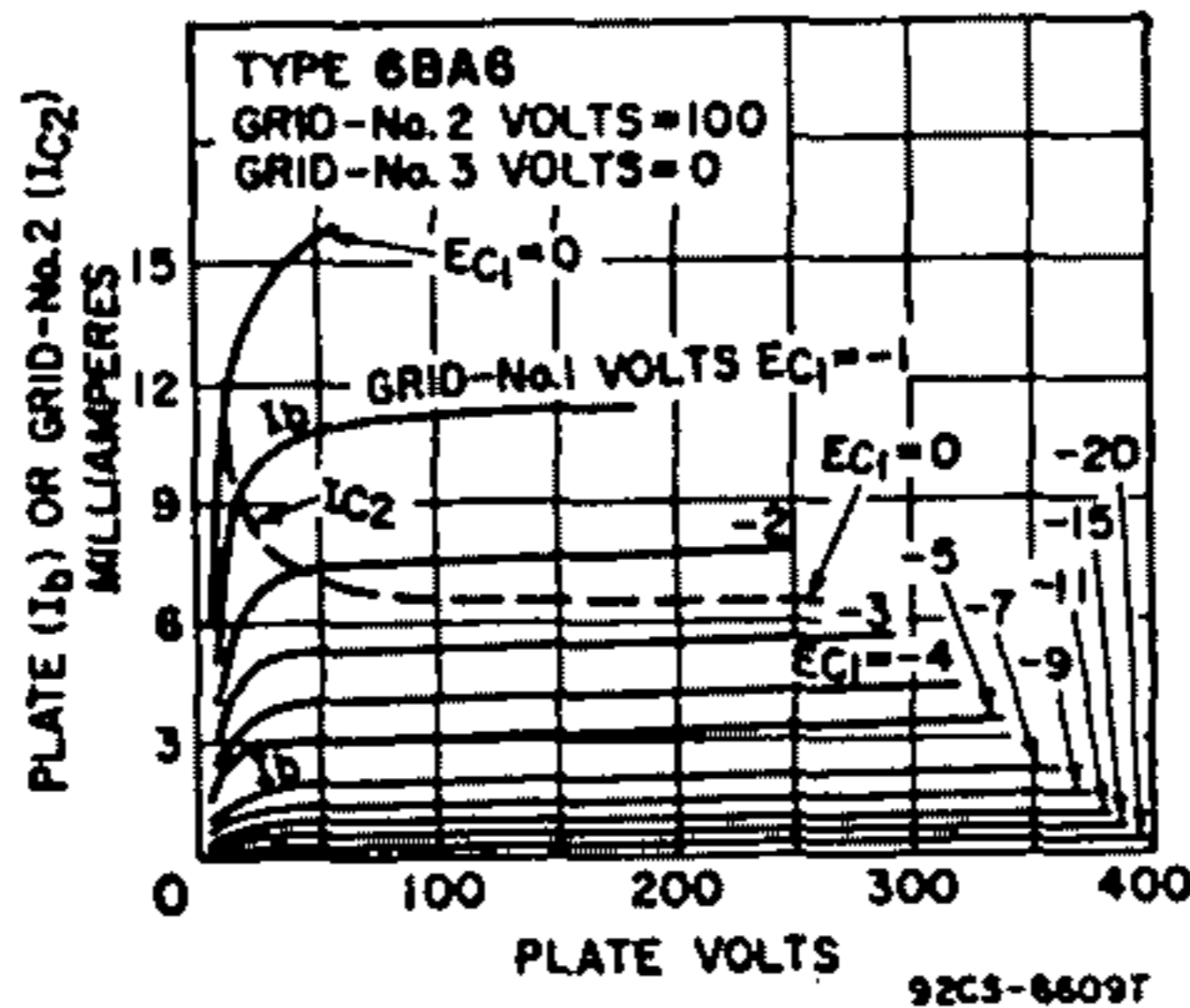
**Class A<sub>1</sub> Amplifier**

**MAXIMUM RATINGS (Design-Maximum Values)**

Plate Voltage	330	volts
Grid-No.3 (Suppressor-Grid) Voltage, Positive value	0	volts
Grid-No.2 (Screen-Grid) Voltage	See curve page 96	
Grid-No.2 Supply Voltage	330	volts
Plate Dissipation	3.4	watts
<b>Grid-No.2 Input:</b>		
For grid-No.2 voltages up to 165 volts	0.7	watt
For grid-No.2 voltages between 165 and 330 volts	See curve page 96	
<b>Grid-No.1 (Control-Grid) Voltage:</b>		
Negative-bias value	-55	volts
Positive-bias value	0	volts

**CHARACTERISTICS**

Plate Supply Voltage	100	250	volts
Grid No.3 and Internal Shield	Connected to cathode at socket		
Grid-No.2 Supply Voltage	100	100	volts
Cathode-Bias Resistor	68	68	ohms
Plate Resistance (Approx.)	0.25	1.0	megohm
Transconductance	4300	4400	μmhos
Plate Current	10.8	11	mA
Grid-No.2 Current	4.4	4.2	mA
Grid-No.1 Voltage (Approx.) for transconductance of 40 μmhos	-20	-20	volts



**Installation and Application**

Control-grid bias variation is effective in changing the volume of the receiver. To obtain adequate volume control, an available grid-No.1-bias voltage of approximately 50 volts is required. The exact value depends upon the circuit design and operating conditions. This voltage may be obtained, depending on the receiver requirements, from a potentiometer across a fixed supply voltage, from a variable cathode-bias resistor, from the avc system, or from a combination of these methods.

The grid-No.2 (screen-grid) voltage may be obtained from a potentiometer or bleeder circuit across the B-supply source, or through a dropping resistor from the plate supply. The use of series resistors for obtaining satisfactory control of grid-No.2 voltage in the case of four-electrode tubes is usually impossible because of secondary-emission phenomena. In the 6BA6, however, because grid No.3 practically removes these effects, it is practical to obtain grid-No.2 voltage through a series-dropping resistor from the plate supply or from some high intermediate voltage, provided the source does not exceed the plate-supply voltage. With this method, the grid-No.2-to-cathode voltage will fall off very little from minimum to maximum value of the resistor controlling cathode bias. In some cases, it may actually rise. This rise of grid-No.2-to-cathode voltage above the normal maximum value is allowable because both the grid-No.2 current and the plate current are reduced simultaneously by a sufficient amount to prevent damage to the tube. It should be recognized that, in general, the series-resistor method of obtaining grid-No.2 voltage from a higher voltage supply necessitates the use of the variable cathode-resistor method of controlling volume in order to prevent too high a voltage on grid No.2. When grid-No.2 and control-grid voltage are obtained in this manner, the remote "cutoff" advantage of the 6BA6 can be fully realized. However, it should be noted that the use of a resistor in the grid-No.2 circuit has an effect on the change in plate resistance with variation in grid-No.3 (suppressor-grid) voltage in case grid No.3 is utilized for control purposes.



BCT

**PENTAGRID CONVERTER**

**6BA7**

Miniature type used as converter in AM and FM receivers. Outlines section, 6E; requires miniature 9-contact socket.

Heater Voltage .....	6.3	volts
Heater Current .....	0.3	ampere
Peak Heater-Cathode Voltage .....	±90	volts
Direct Interelectrode Capacitances:		
Grid No. 3 to All Other Electrodes .....	9.5	pF
Plate to All Other Electrodes .....	8.3	pF
Grid No. 1 to All Other Electrodes .....	6.7	pF
Grid No. 3 to Plate .....	0.19 max	pF
Grid No. 3 to Grid No. 1 .....	0.1 max	pF
Grid No. 1 to Plate .....	0.05 max	pF
Grid No. 1 to All Other Electrodes, except Cathode .....	3.4	pF
Grid No. 1 to Cathode .....	3.3	pF
Cathode to All Other Electrodes except Grid No. 1 .....	4.0	pF

**Converter Service**

**MAXIMUM RATINGS (Design-Center Values)**

Plate Voltage .....	300	volts
Grid-No.5-and-Internal-Shield Voltages .....	0	volts
Grids-No.2-and-No.4 (Screen-Grid) Voltage .....	100	volts
Grids-No.2-and-No.4 Supply Voltage .....	300	volts
Plate Dissipation .....	2.0	watts
Grids-No.2-and-No.4 Input .....	1.5	watts
Total Cathode Current .....	22	mA
Grid-No.3 Voltage:		
Negative-bias value .....	-100	volts
Positive-bias value .....	0	volts

**CHARACTERISTICS (Separate Excitation)\***

Plate Voltage .....	100	250	volts
Grid No.5 and Internal Shields .....	Connected directly to ground		
Grids-No.2-and-No.4 (Screen-Grid) Voltage .....	100	100	volts



Grid-No.3 (Control-Grid) Voltage	-1.0	-1.0	volt
Grid-No.1 (Oscillator-Grid) Resistor	20000	20000	ohms
Plate Resistance (Approx.)	0.5	1.0	megohm
Conversion Transconductance	900	950	μmhos
Conversion Transconductance (Approx.)**	3.5	3.5	μmhos
Plate Current	8.6	8.8	mA
Grids-No.2-and-No.4 Current	10.2	10	mA
Grid-No.1 Current	0.35	0.35	mA
Total Cathode Current	14.2	14.2	mA

NOTE: The transconductance between grid No.1 and grids No.2 and No.4 connected to plate (not oscillating) is approximately 8000 μmhos under the following conditions: signal applied to grid No.1 at zero bias; grids No.2 and No.4 and plate at 100 volts; grid No.3 grounded. Under the same conditions, the plate current is 82 milliamperes, and the amplification factor is 16.5.

\* The characteristics shown with separate excitation correspond very closely with those obtained in a self-excited oscillator circuit operating with zero bias.

\*\* With grid-No.3 bias of -20 volts.

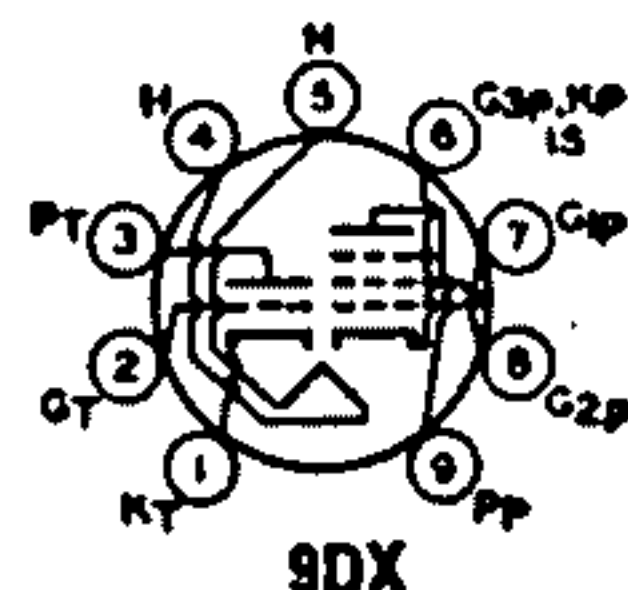
▲ Internal Shield (pins No.6 and No.8) connected directly to ground.

# 6BA8A

8BA8A

## MEDIUM-MU TRIODE— SHARP-CUTOFF PENTODE

Miniature type used in color and black-and-white television receivers. The pentode unit is used as a video amplifier, an agc amplifier, or a reactance tube. The triode unit is used in low-frequency oscillator and phase-splitter circuits. Outlines section, 6E; requires miniature 9-contact socket. Type 8BA8A is identical with type 6BA8A except for the heater ratings.



	6BA8A	8BA8A	
Heater Voltage (ac/dc)	6.3	8.4	volts
Heater Current	0.3	0.45	ampere
Heater Warm-up Time (Average)	11	—	seconds
Heater-Cathode Voltage:			
Peak value	±100 max	±200 max	volts
Average value	100 max	100 max	volts
Direct Interelectrode Capacitances (Approx.):			
Triode Unit:			
Grid to Plate	2.2	2.2	pF
Grid to Cathode and Heater	2.5	2.7	pF
Plate to Cathode and Heater	0.4	1.9	pF
Pentode Unit:			
Grid No.1 to Plate	0.06	0.05	pF
Grid No.1 to Cathode, Heater, Grid No.2, Grid No.3, and Internal Shield	10	10	pF
Plate to Cathode, Heater, Grid No.2, Grid No.3, and Internal Shield	3.5	4.5	pF
Triode Grid to Pentode Plate	0.016	0.006	pF
Pentode Grid No.1 to Triode Plate	0.006	0.003	pF
Pentode Plate to Triode Plate	0.15	0.023	pF

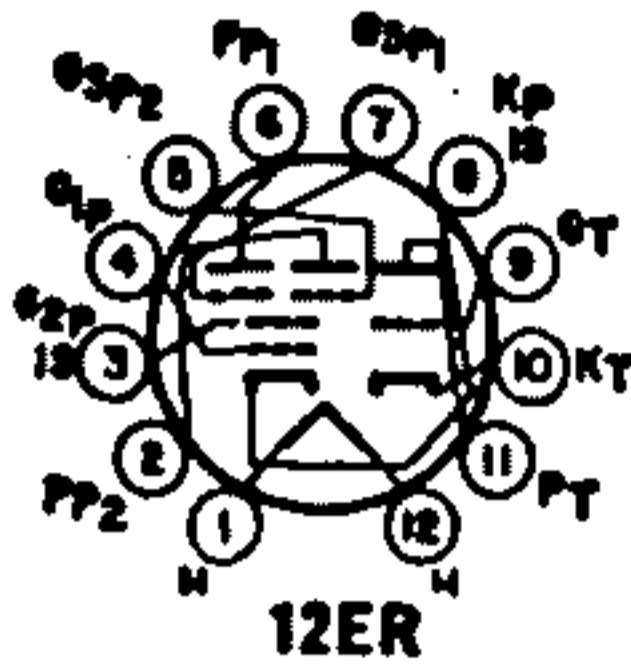
\* With external shield connected to cathode of unit under test.

### Class A<sub>1</sub> Amplifier

	Triode Unit	Pentode Unit	
<b>MAXIMUM RATINGS (Design-Center Values)</b>			
Plate Voltage	300	300	volts
Grid-No.2 (Screen-Grid) Supply Voltage	—	300	volts
Grid-No.2 Voltage	—	See curve page 96	
Grid-No.1 (Control-Grid) Voltage:			
Negative-bias value	—	-50	volts
Positive-bias value	—	0	volts
Plate Dissipation	2	3.25	watts
Grid-No.2 Input:			
For grid-No.2 voltages up to 150 volts	—	1	watt
For grid-No.2 voltages between 150 and 300 volts	—	See curve page 96	
<b>CHARACTERISTICS</b>			
Plate-Supply Voltage	200	200	volts
Grid-No.2 Supply Voltage	—	150	volts
Grid-No.1 Voltage	-8	—	volts
Cathode-Bias Resistor	—	180	ohms
Amplification Factor	18	—	
Plate Resistance (Approx.)	6700	400000	ohms
Transconductance	2700	9000	μmhos
Plate Current	8	13	mA
Grid-No.2 Current	—	3.5	mA
Grid-No.1 Voltage (Approx.) for plate current of 10 μA	-16	-10	volts

**MAXIMUM CIRCUIT VALUES**

Grid-No.1-Circuit Resistance:			
For fixed-bias operation .....	0.5	0.25	megohm
For cathode-bias operation .....	1.0	1.0	megohm



**TRIODE—TWIN PENTODE**

**6BA11**  
8BA11

Duodecar type used as vertical-deflection oscillator and for combined sync-age applications in color and black-and-white television receivers. Outlines section, 8B; requires duodecar 12-contact socket. Type 8BA11 is identical with type 6BA11 except for heater ratings.

	<b>6BA11</b>	<b>8BA11</b>	
Heater Voltage (ac/dc) .....	6.3	8.4	volts
Heater Current .....	0.6	0.45	amperes
Heater Warm-up Time .....	11	11	seconds
Heater-Cathode Voltage:			
Peak value .....	±200 max	±200 max	volts
Average value .....	100 max	100 max	volts
Direct Interelectrode Capacitances:			
Triode Unit:			
Grid to Plate .....		2.0	pF
Grid to Cathode and Heater .....		2.0	pF
Plate to Cathode, Heater, and Internal Shield .....		1.9	pF
Pentode Unit (Each Unit):			
Grid No.3 to Plate .....		2.0	pF
Grid No.3 to all Other Electrodes .....		3.6	pF
Grid No.1 to all Other Electrodes .....		3.0	pF
Plate to all Other Electrodes .....		3.0	pF
Grid No.3 of Pentode 1 to Grid No.3 of Pentode 2 .....		0.026 max	pF

**Triode Unit as Class A<sub>1</sub> Amplifier**

**MAXIMUM RATINGS (Design-Center Values)**

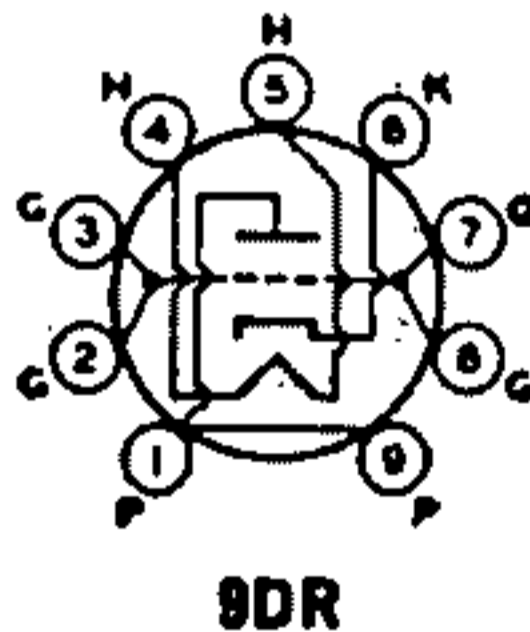
Plate Voltage .....	300	volts
Average Cathode Current .....	20	mA
Plate Dissipation .....	1.5	watts

**CHARACTERISTICS**

Plate Voltage .....	250	volts
Grid Voltage .....	-11	volts
Amplification Factor .....	18	
Transconductance .....	1800	μmhos
Plate Current .....	5	mA
Grid Voltage (Approx.) for plate current of 100 μA .....	-18	volts

**MAXIMUM CIRCUIT VALUES**

Grid-Circuit Resistance:		
For fixed-bias operation .....	0.25	megohm
For cathode-bias operation .....	1	megohm



**MEDIUM-MU TRIODE**

**6BC4**

Miniature type used as an rf amplifier in the cathode-drive circuits of uhf television tuners covering the frequency range of 470 to 890 MHz. Outlines section, 6A; requires miniature 9-contact socket.

Heater Voltage (ac/dc) .....	6.3	volts
Heater Current .....	0.225	ampere
Peak Heater-Cathode Voltage .....	±75 max	volts
Direct Interelectrode Capacitances (Approx.):		
Grid to Plate .....	1.6	pF
Grid to Heater and Cathode .....	2.9	pF
Plate to Heater and Cathode .....	0.26	pF
Heater to Cathode .....	2.7	pF

**Class A<sub>1</sub> Amplifier**

**MAXIMUM RATINGS (Design-Center Values)**

Plate Voltage .....	250	volts
Cathode Current .....	25	mA
Plate Dissipation .....	2.5	watts

**CHARACTERISTICS**

Plate Supply Voltage .....	150	volts
Cathode-Bias Resistor .....	100	ohms
Amplification Factor .....	48	
Plate Resistance (Approx.) .....	4800	ohms
Transconductance .....	10000	$\mu$ mhos
Plate Current .....	14.5	mA
Grid Voltage (Approx.) for plate current of 10 $\mu$ A .....	-10	volts

**MAXIMUM CIRCUIT VALUES**

Grid-Circuit Resistance:		
For fixed-bias operation .....		Not recommended
For cathode-bias operation .....	0.6	megohm

**6BC5**

3BC5/3CE5

**SHARP-CUTOFF PENTODE**

Miniature type used in compact radio equipment as an rf or if amplifier at frequencies up to 400 MHz. Outlines section, 5C; requires miniature 7-contact socket. For typical operation as resistance-coupled amplifier, refer to Resistance-Coupled Amplifier section. Type 3BC5/3CE5 is identical with type 6BC5 except for heater ratings.



7B0

	3BC5/3CE5	6BC5	
Heater Voltage (ac/dc) .....	8.15	8.3	volts
Heater Current .....	0.6	0.3	ampere
Heater Warm-up Time (Average) .....	11	—	seconds
Heater-Cathode Voltage:			
Peak value .....	$\pm 200$ max	$\pm 90$ max	volts
Average value .....	100 max	—	volts
<i>Direct Interelectrode Capacitances:</i>			
Pentode Connection:			
Grid No.1 to Plate .....		0.080 max	PF
Grid No.1 to Cathode, Heater, Grid No.2, Grid No.3, and Internal Shield .....		6.5	PF
Plate to Cathode, Heater, Grid No.2, Grid No.3, and Internal Shield .....		1.8	PF
Triode Connection:*			
Grid No.1 to Plate and Grid No.2 .....		2.5	PF
Grid No.1 to Cathode, Heater, Grid No.3, and Internal Shield ..		8.9	PF
Plate and Grid No.2 to Cathode, Heater, Grid No.3, and Internal Shield .....		3.0	PF

\* Grid No.2 connected to plate.

**Class A<sub>1</sub> Amplifier**

**MAXIMUM RATINGS (Design-Center Values)**

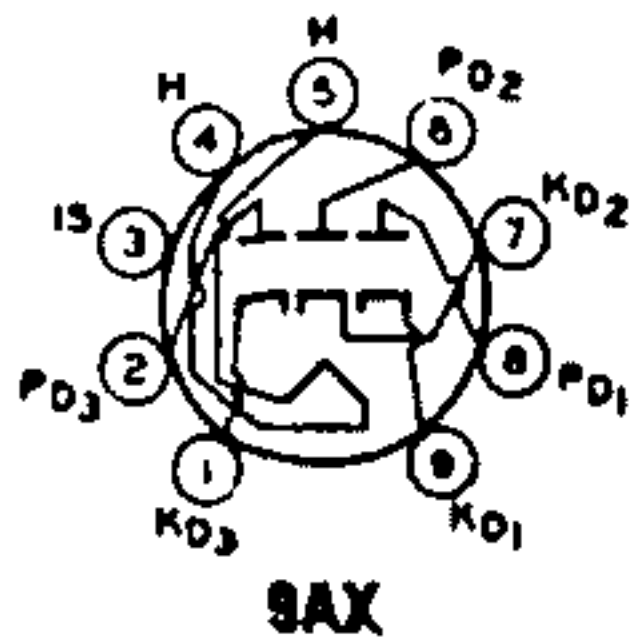
	Triode Connection*	Pentode Connection	
Plate Voltage .....	300	300	volts
Grid-No.2 (Screen-Grid) Supply Voltage .....	—	300	volts
Grid-No.2 Voltage .....	—	See curve page 96	
Grid-No.1 (Control-Grid) Voltage, Positive-bias value .....	0	0	volts
Plate Dissipation .....	2.5	2	watts
Grid-No.2 Input:			
For grid-No.2 voltages up to 150 volts .....	—	0.5	watt
For grid-No.2 voltages between 150 and 300 volts .....	—	See curve page 96	

**CHARACTERISTICS**

	Triode Connection*		Pentode Connection			
Plate Supply Voltage .....	180	250	100	125	250	volts
Grid-No.2 Supply Voltage .....	—	—	100	125	150	volts
Cathode-Bias Resistor .....	330	820	180	100	180	ohms
Amplification Factor .....	42	40	—	—	—	
Plate Resistance (Approx.) .....	0.006	0.009	0.6	0.5	0.8	megohm
Transconductance .....	6000	4400	4900	6100	5700	$\mu$ mhos
Plate Current .....	8	6	4.7	8	7.5	mA
Grid-No.2 Current .....	—	—	1.4	2.4	2.1	mA
Grid-No.1 Voltage (Approx.) for Plate current of 10 $\mu$ A .....	—	—	-5	-6	-8	volts

\* Grid No.2 connected to plate.





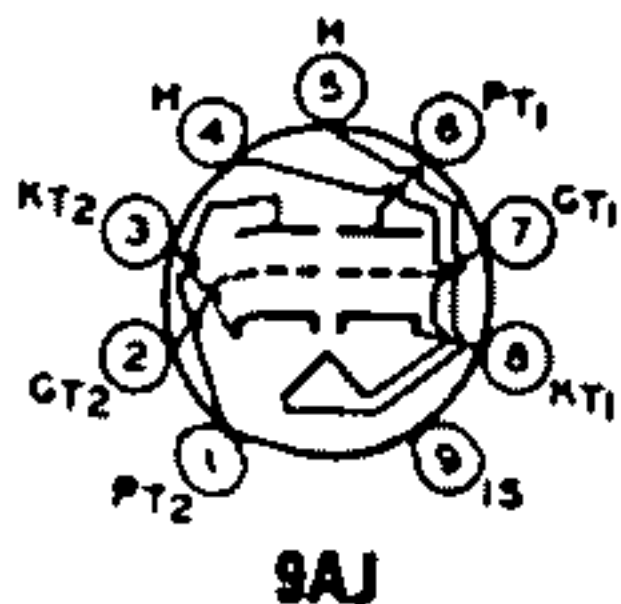
**TRIPLE DIODE**

**6BC7**

Miniature type containing three high-perveance diode units in one envelope; used in dc restorer circuits of color television receivers and in AM/FM radio receivers as a combination FM discriminator and AM detector tube. Outlines section, 6B; requires 9-contact miniature socket.

Heater Voltage (ac/dc) .....	6.3	volts
Heater Current .....	0.450	ampere
Peak Heater-Cathode Voltage .....	±200 max	volts
<b>Direct Interelectrode Capacitances (Approx.):</b>		
Diode-No.1 Plate to Diode-No.1 Cathode, Heater, and Internal Shield .....	3.5	pF
Diode-No.2 Plate to Diode-No.2 Cathode, Heater, and Internal Shield .....	5.5	pF
Diode-No.3 Plate to Diode-No.3 Cathode, Heater, and Internal Shield .....	3.5	pF
<b>MAXIMUM RATINGS (Design-Center Values, Each Diode Unit)</b>		
Peak Inverse Plate Voltage .....	330	volts
Peak Plate Current* .....	54	mA
Average Output Current .....	12	mA

\* In rectifier service, the minimum total effective plate-supply impedance per plate is 560 ohms.



**MEDIUM-MU TWIN TRIODE**

**6BC8**  
4BC8

Miniature type used as a cascode amplifier in vhf television tuners and in push-pull cathode-drive rf amplifiers. Outlines section, 6B; requires miniature 9-contact socket. Type 4BC8 is identical with type 6BC8 except for heater ratings.

Heater Voltage (ac/dc) .....	4BC8 4.2	6BC8 6.3	volts
Heater Current .....	0.6	0.4	ampere
Heater Warm-up Time (Average) .....	11	—	seconds
Heater-Cathode Voltage:			
Peak value .....	±200*max	±200*max	volts
Average value .....	100 max	100 max	volts
<b>Direct Interelectrode Capacitances*:</b>			
Grid to Plate .....	Unit No.1 1.2	Unit No.2 1.2	pF
Grid to Cathode, Heater, and Internal Shield .....	2.6	—	pF
Cathode to Grid, Heater, and Internal Shield .....	—	5.5	pF
Plate to Cathode, Heater, and Internal Shield .....	1.3	—	pF
Plate to Grid, Heater, and Internal Shield .....	—	2.4	pF
Plate to Cathode .....	—	0.12	pF
Heater to Cathode .....	2.8	2.8	pF
Plate of Unit No.1 to Plate of Unit No.2 .....	0.02 max	—	pF
Plate of Unit No.2 to Plate and Grid of Unit No.1 .....	0.04 max	—	pF

\* Rating may be as high as 300 volts under cutoff conditions, when tube is used as a cascode amplifier, the two units are connected in series, and heater is negative with respect to cathode.

\* With external shield connected to internal shield.

**Class A<sub>1</sub> Amplifier (Each Unit)**

<b>MAXIMUM RATINGS (Design-Maximum Values)</b>		
Plate Voltage .....	250*	volts
Cathode Current .....	22	mA
Plate Dissipation .....	2.2	watts
<b>CHARACTERISTICS</b>		
Plate Supply Voltage .....	150	volts
Cathode-Bias Resistor .....	220	ohms
Plate Resistance (Approx.) .....	5300	ohms
Amplification Factor .....	35	
Transconductance .....	6200	μmhos
Plate Current .....	10	mA
Grid Voltage (Approx.) for transconductance of 50 μmhos .....	-13	volts

**MAXIMUM CIRCUIT VALUES**

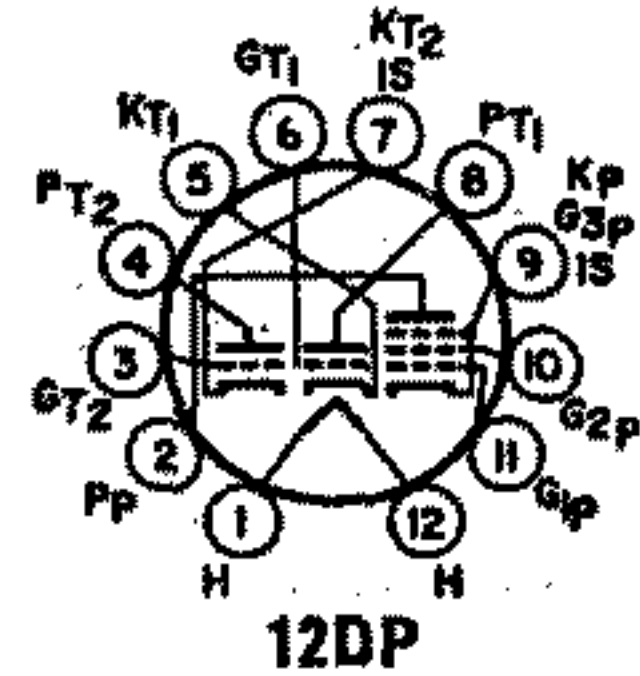
Grid-Circuit Resistance ..... 0.5 megohm  
 \* Rating may be as high as 300 volts under cutoff conditions, when tube is used as a cascode amplifier, the two units are connected in series, and heater is negative with respect to cathode.

**6BD4**  
**6BD4A** Refer to chart at end of section.

**6BD6** Refer to chart at end of section.

**6BD11** **DUAL TRIODE—**  
**15BD11** **SHARP-CUTOFF PENTODE**

Duodecar type used in television receiver applications. The high-mu triode unit No.1 is used in general-purpose applications, the medium-mu triode unit No.2 in sync-separator circuits, and the pentode unit as a video amplifier. Outlines section, 8B; requires duodecar 12-contact socket. Type 15BD11 is identical with type 6BD11 except for heater ratings.



	6BD11	15BD11	
Heater Voltage (ac/dc) .....	6.3	14.7	volts
Heater Current .....	1.05	0.45	amperes
Heater Warm-up Time (Average) .....	—	11	seconds
Heater-Cathode Voltage:			
Peak value .....	±200 max	±200 max	volts
Average value .....	100 max	100 max	volts

	Triode Unit No.1	Triode Unit No.2	Pentode Unit	
<b>MAXIMUM RATINGS (Design-Maximum Values)</b>				
Plate Voltage .....	330	330	330	volts
Grid-No.2 (Screen-Grid) Supply Voltage .....	—	—	330	volts
Grid-No.2 Voltage .....	—	—	See curve page 96	
Grid-No.1 (Control-Grid) Voltage, Positive-bias value .....	0	0	0	volts
Plate Dissipation .....	1.5	2	4	watts
Grid-No.2 Input:				
For grid-No.2 voltages up to 165 volts .....	—	—	1.1	watts
For grid-No.2 voltages between 165 and 330 volts .....	—	—	See curve page 96	

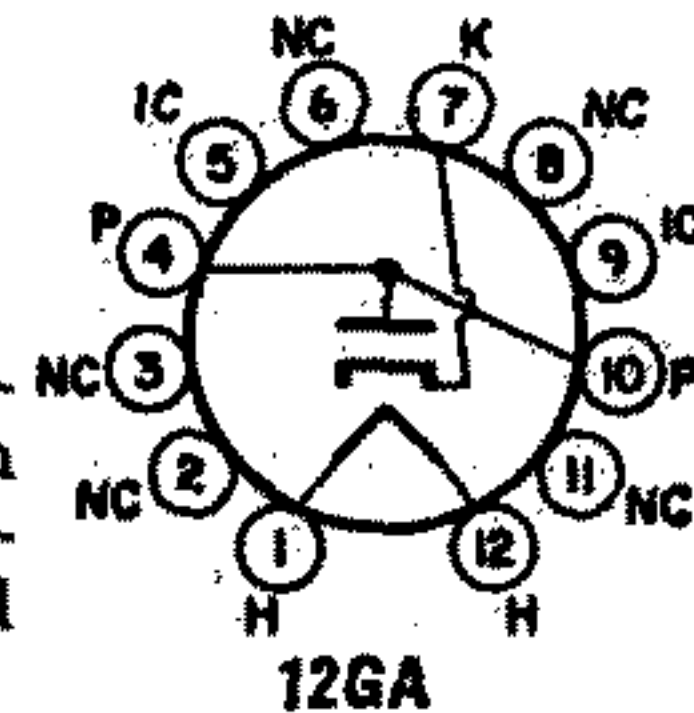
	Triode Unit No.1	Triode Unit No.2	Pentode Unit		
<b>CHARACTERISTICS</b>					
Plate Supply Voltage .....	200	200	35	135	volts
Grid-No.2 Supply Voltage .....	—	—	135	135	volts
Grid-No.1 Voltage .....	—2	—	0	0	volts
Cathode-Bias Resistor .....	—	220	—	100	ohms
Amplification Factor .....	68	41	—	—	
Plate Resistance (Approx.) .....	12400	9400	—	45000	ohms
Transconductance .....	5500	4400	—	10400	μmhos
Plate Current .....	7	9.2	34*	17	mA
Grid-No.2 Current .....	—	—	13*	4	mA
Grid-No.1 Voltage (Approx.) for plate current of 100 μA .....	—5.5	—6.5	—	—6	volts

	Triode Unit No.1	Triode Unit No.2	Pentode Unit	
<b>MAXIMUM CIRCUIT VALUES</b>				
Grid-No.1-Circuit Resistance:				
For fixed-bias operation .....	0.5	0.5	1	megohm
For cathode-bias operation .....	1	1	1	megohm

\* This value may be measured by a method involving a recurrent waveform such that the maximum ratings of the tube will not be exceeded.

**6BE3** **HALF-WAVE**  
**12BE3, 17BE3** **VACUUM RECTIFIER**

Duodecar type used as damper tube in horizontal-deflection circuits of color and black-and-white television receivers. Outlines section, 8D; requires duodecar 12-contact socket. Types 12BE3 and 17BE3 are identical with type 6BE3 except for heater ratings.



	6BE3	12BE3	17BE3	
Heater Voltage (ac/dc) .....	6.3	12.6	16.8	volts
Heater Current .....	1.2	0.6	0.46	ampere
Heater Warm-up Time (Average) .....	—	11	11	seconds
Direct Interelectrode Capacitances (Approx.):				
Plate to Cathode, and Heater .....			10	pF
Cathode to Heater, and Plate .....			8.0	pF
Heater to Cathode .....			3.4	pF

**Damper Service**

For operation in a 525-line, 30-frame system

**MAXIMUM RATINGS (Design-Maximum Values)**

Peak Inverse Plate Voltage# .....	5000	volts	
Peak Plate Current .....	1200	mA	
Average Plate Current .....	200	mA	
Plate Dissipation .....	6.5	watts	
Heater-Cathode Voltage:			
Peak value .....	+300	—5000	volts
Average value .....	+100	—900	volts

**CHARACTERISTICS, Instantaneous Value**

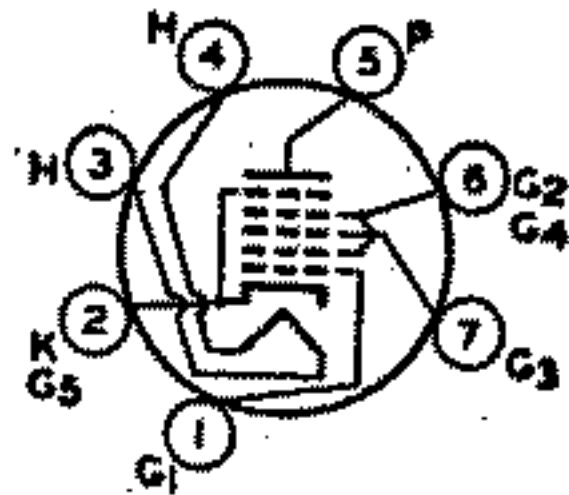
Tube Voltage Drop for dc plate current of 350 mA .....	25	volts
--	----	-------

# Pulse duration must not exceed 15% of a horizontal scanning cycle (10 microseconds).

**PENTAGRID CONVERTER**

**6BE6**

3BE6, 12BE6



7CH

Miniature type used as converter in AM and FM receivers. Outlines section, 5C; requires miniature 7-contact socket. The 6BE6 is similar in performance to metal type 6SA7. For general discussion of pentagrid types, see Frequency Conversion in Electron Tube Applications section. Types 3BE6 and 12BE6 are identical with type 6BE6 except for heater ratings.

	3BE6	6BE6	12BE6	
Heater Voltage (ac/dc) .....	3.15	6.3	12.6	volts
Heater Current .....	0.6	0.3	0.15	ampere
Heater Warm-up Time (Average) .....	11	—	—	seconds
Heater-Cathode Voltage:				
Peak value .....	±200 max	±200 max	±200 max	volts
Average value .....	100 max	100 max	100 max	volts
Direct Interelectrode Capacitances:				
Grid No.3 to Plate .....	Unshielded	Shielded*		pF
Grid No.3 to Grid No.1 .....	0.30 max	0.25 max		pF
Grid No.1 to Plate .....	0.15 max	0.15 max		pF
Grid No.3 to All Other Electrodes .....	0.10 max	0.05 max		pF
Grid No.1 to All Other Electrodes .....	7.0	7.0		pF
Plate to All Other Electrodes .....	5.5	5.5		pF
Grid No.1 to Cathode and Grid No.5 .....	8.0	13.0		pF
Cathode and Grid No.5 to All Other Electrodes except Grid No.1 .....	3.0	3.0		pF
	15.0	20.0		pF

\* With external shield connected to cathode and grid No.5.

**Converter**

**MAXIMUM RATINGS (Design-Maximum Values)**

Plate Voltage .....	330	volts
Grids-No.2-and-No.4 (Screen-Grid) Voltage .....	110	volts
Grids-No.2-and-No.4 Supply Voltage .....	330	volts
Cathode Current .....	15.5	mA
Plate Dissipation .....	1.1	watts
Grids-No.2-and-No.4 Input .....	1.1	watts
Grid-No.3 Voltage:		
Negative-bias value .....	—55	volts
Positive-bias value .....	0	volts
Heater-Cathode Voltage:		
Peak value .....	200	volts
Average value .....	100	volts

**TYPICAL OPERATION (Separate Excitation)\***

Plate Voltage .....	100	250	volts
Grids-No.2-and-No.4 (Screen-Grid) Voltage .....	100	100	volts
Grid-No.1 (Oscillator-Grid) Voltage (rms) .....	10	10	volts
Grid-No.3 (Control-Grid) Voltage .....	—1.5	—1.5	volts
Grid-No.1 (Oscillator-Grid) Resistor .....	20000	20000	ohms
Plate Resistance (Approx.) .....	0.4	1.0	megohm



Conversion Transconductance .....	455	475	μmhos
Plate Current .....	2.6	2.9	mA
Grids-No.2-and-No.4 Current .....	7.0	6.8	mA
Grid-No.1 Current .....	0.5	0.5	mA
Cathode Current .....	10.1	10.2	mA
Grid-No.3 Voltage for conversion transconductance of 10 μmhos .....	-30	-30	volts

NOTE: The transconductance between grid No.1 and grids No.2 and No.4 connected to plate (not oscillating) is approximately 7250 μmhos under the following conditions: grids No.1 and No.3 at 0 volts; grids No.2 and No.4 and plate at 100 volts. Under the same conditions, the cathode current is 25 mA, and the amplification factor is 20. Grid-No.1 voltage (Approx.) for plate current of 10 μA is -11 volts.

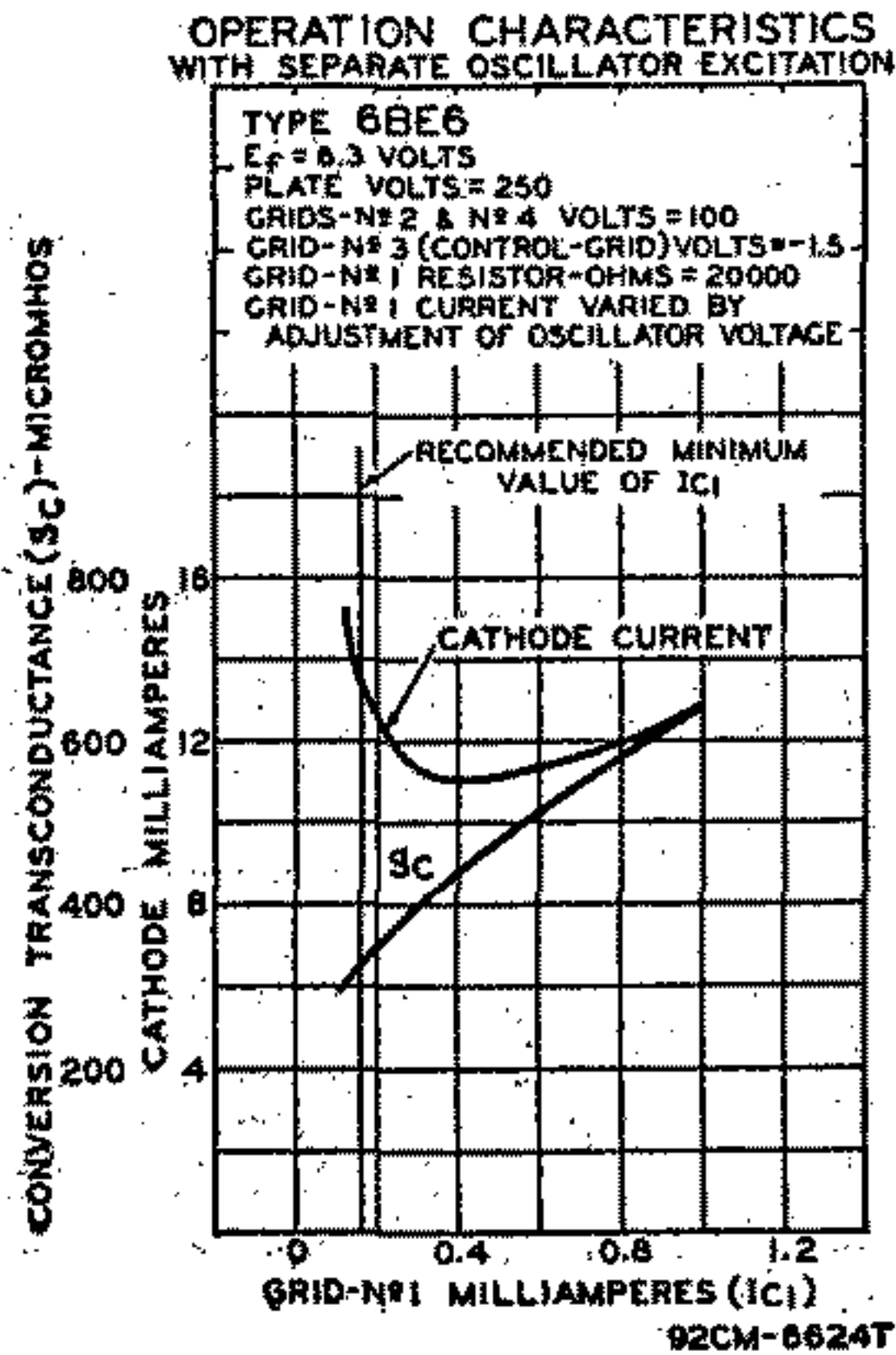
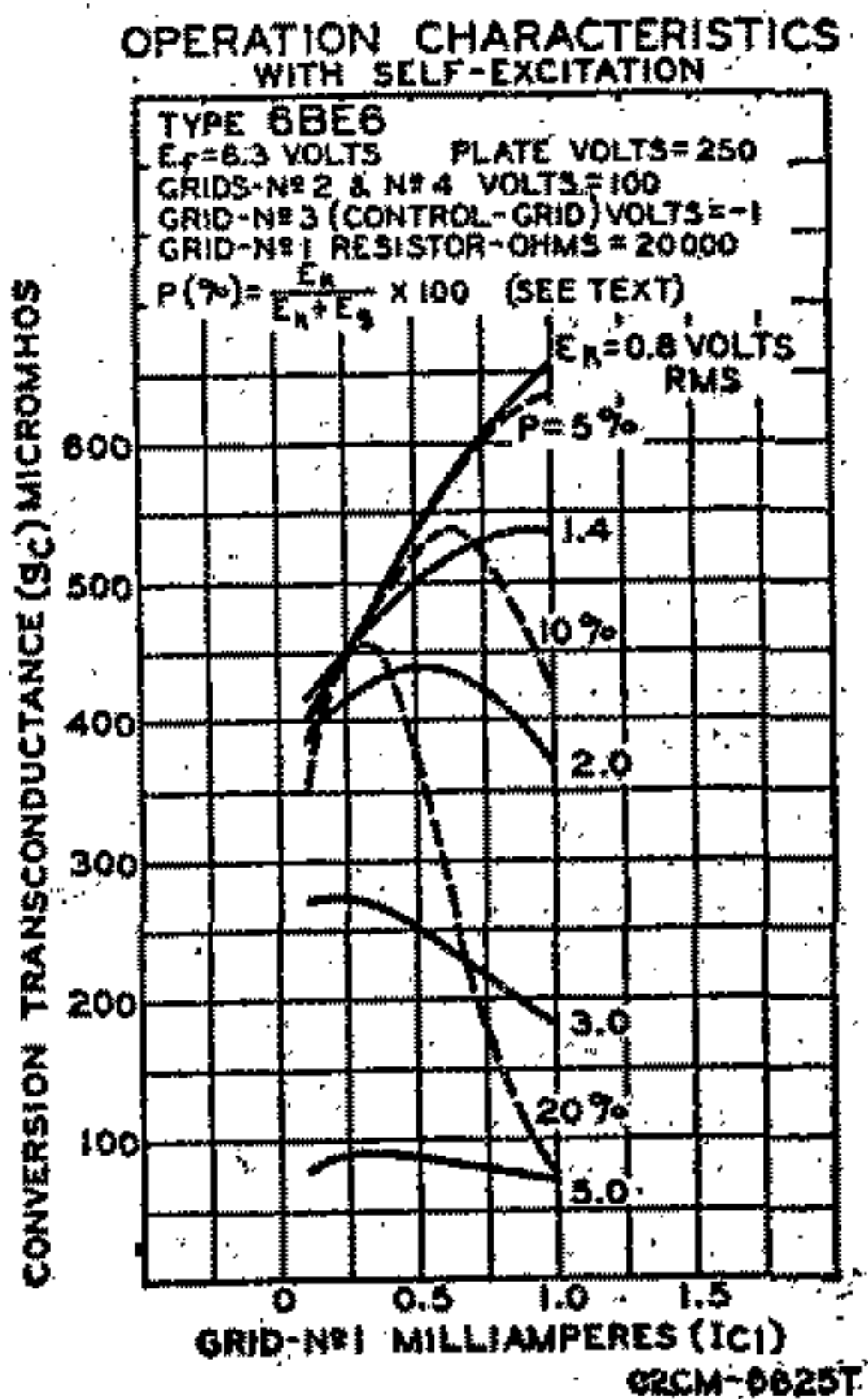
\* The characteristics shown with separate excitation correspond very closely with those obtained in a self-excited circuit operating with zero bias.

### Installation and Application

Because of the special structural arrangement of the 6BE6, a change in signal-grid voltage produces little change in cathode current. Consequently, an rf voltage on the signal grid produces little modulation of the electron current flowing in the cathode circuit. This feature is important because it is desirable that the impedance in the cathode circuit should produce little degeneration or regeneration of the signal-frequency input and intermediate-frequency output. Another important feature is that, because signal-grid voltage has very little effect on the space charge near the cathode, changes in avc bias produce little change in oscillator transconductance and in the input capacitance of grid No.1. There is, therefore, little detuning of the oscillator by avc bias.

A typical self-excited oscillator circuit employing the 6BE6 is given in the Circuits section.

In the 6BE6 operation characteristics curves with self-excitation,  $E_r$  is the voltage across the oscillator-coil section between cathode and ground;  $E_s$  is the oscillator voltage between cathode and grid.

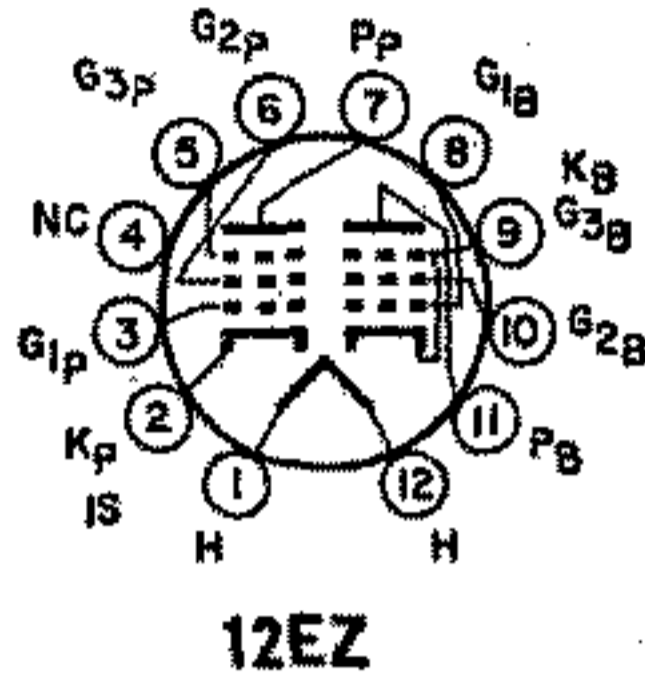


**6BF5**

Refer to chart at end of section.

**6BF6**

Refer to chart at end of section.



**BEAM POWER TUBE—  
SHARP-CUTOFF PENTODE**

**6BF11**

12BF11, 17BF11

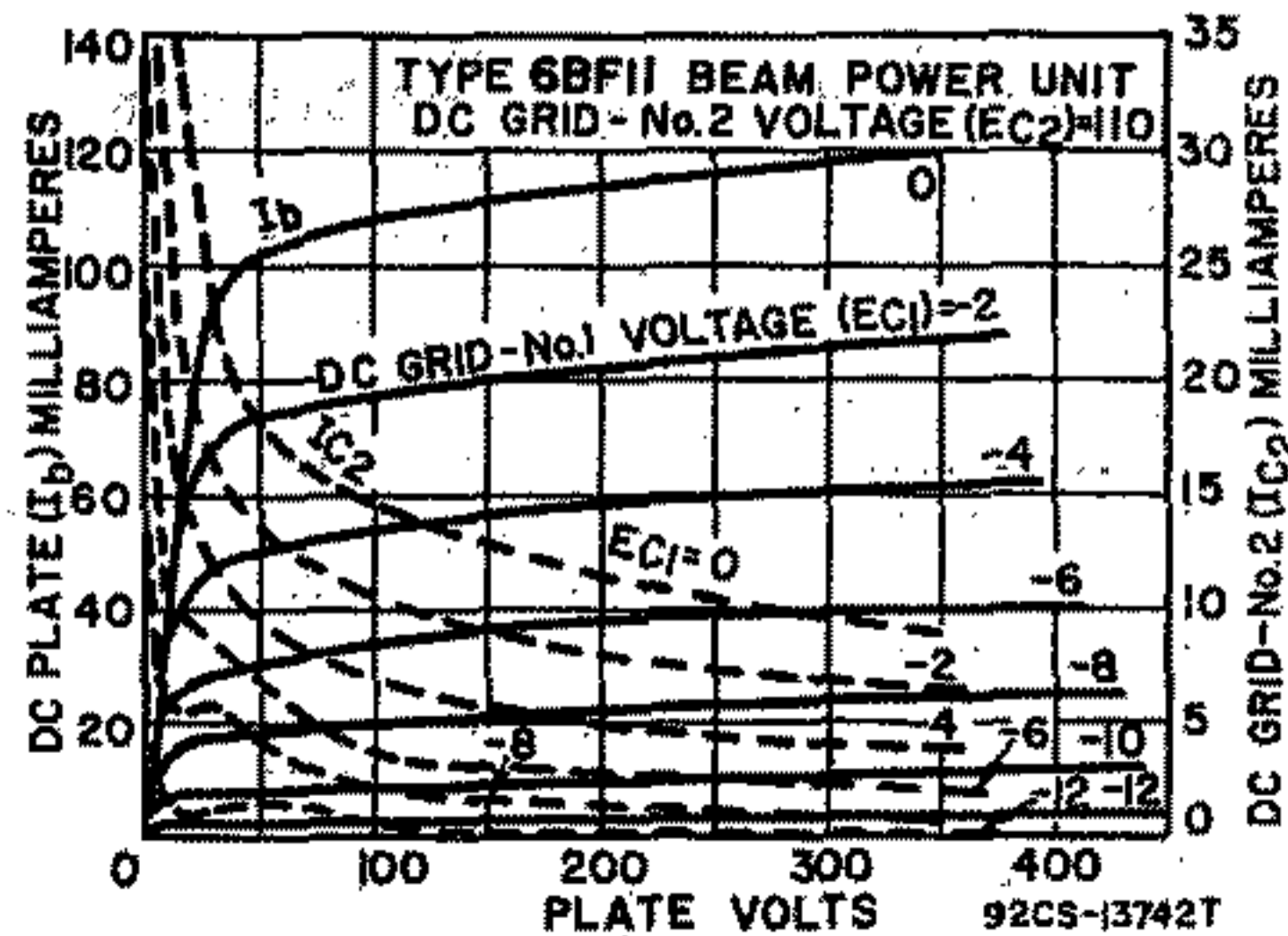
Duodecar type used as combined detector and amplifier tube in color and black-and-white television receivers. The dual-control, sharp-cutoff pentode unit is used as an FM detector and the beam power unit as an af output amplifier. Outlines section, 8C; requires duodecar 12-contact socket. Types 12BF11 and 17BF11 are identical with type 6BC11 except for heater ratings.

	6BF11	12BF11	17BF11	
Heater Voltage (ac/dc)	6.3	12.6	16.8	volts
Heater Current	1.2	0.6	0.45	amperes
Heater Warm-up Time (Average)	—	11	11	seconds
<b>Heater-Cathode Voltage:</b>				
Peak value		100 max	100 max	volts
Average value		±200 max	±200 max	volts
<b>Direct Interelectrode Capacitances:</b>				
<b>Pentode Unit:</b>				
Grid No.1 to Plate		0.36		pF
Grid No.3 to Plate		3.2		pF
Grid No.1 to Cathode, Heater, Grid No.2, Grid No.3, and Internal Shield		6.5		pF
Grid No.3 to Cathode, Heater, Grid No.1, Grid No.2, Plate, and Internal Shield		8.0		pF
Grid No.1 to Grid No.3		0.11		pF
<b>Beam Power Unit:</b>				
Grid No.1 to Plate		0.24		pF
Grid No.1 to Cathode, Heater, Grid No.2, Grid No.3, and Internal Shield		13		pF
Plate to Cathode, Heater, Grid No.2, Grid No.3, and Internal Shield		10		pF
Pentode Plate to Beam Power Plate		0.13		pF

**Beam Power Unit as Class A<sub>1</sub> Amplifier**

**MAXIMUM RATINGS (Design-Maximum Values)**

Plate Voltage	165	volts
Grid-No.2 (Screen-Grid) Voltage	150	volts
Average Cathode Current	65	mA
Plate Dissipation	6.5	watts
Grid-No.2 Input	1.8	watts

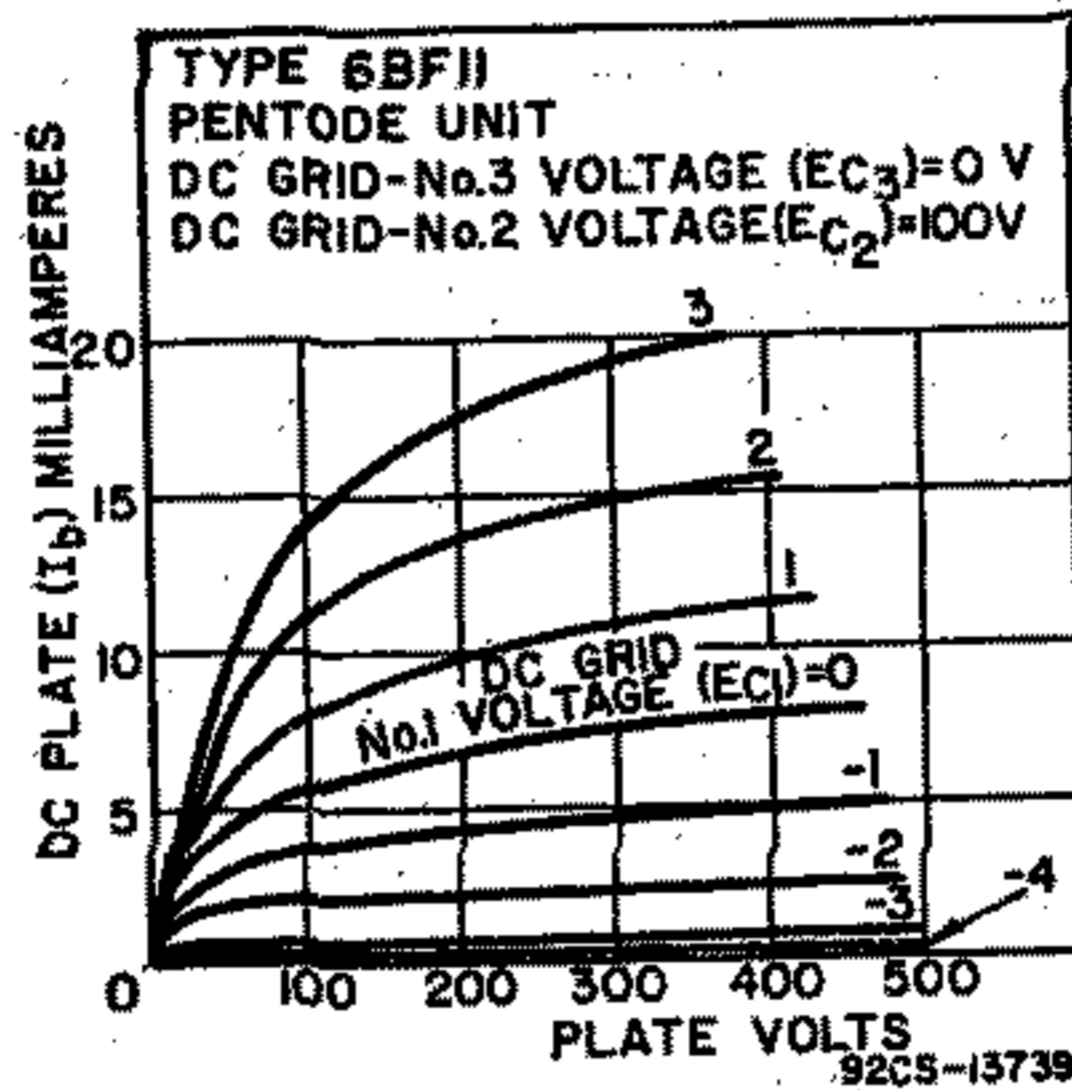


**TYPICAL OPERATION**

Plate Voltage .....	145	volts
Grid-No.2 Voltage .....	110	volts
Grid-No.1 (Control-Grid) Voltage .....	-6	volts
Peak AF Grid-No.1 Voltage .....	6	volts
Zero-Signal Plate Current .....	36	mA
Maximum-Signal Plate Current .....	40	mA
Zero-Signal Grid No.2 Current .....	3	mA
Maximum-Signal Grid-No.2 Current .....	9	mA
Plate Resistance (Approx.) .....	0.03	megohm
Transconductance .....	8600	$\mu$ mhos
Load Resistance .....	3000	ohms
Total Harmonic Distortion .....	10	per cent
Maximum-Signal Power Output .....	2.4	watts

**MAXIMUM CIRCUIT VALUES**

Grid-No.1-Circuit Resistance:		
For fixed-bias operation .....	0.25	megohm
For cathode-bias operation .....	0.5	megohm



**Pentode Unit as Class A<sub>1</sub> Amplifier**

**CHARACTERISTICS**

Plate Supply Voltage .....	150	volts
Grid No.3 (Control-Grid) .....	Connected to negative end of cathode resistor	
Grid-No.2 (Screen-Grid) Supply Voltage .....	100	volts
Grid No.1 (Control Grid) .....	Connected to negative end of cathode resistor	
Cathode-Bias Resistor .....	560	ohms
Plate Resistance (Approx.) .....	0.15	megohm
Transconductance, Grid No.1 to Plate .....	1000	$\mu$ mhos
Transconductance, Grid No.3 to Plate .....	400	$\mu$ mhos
Plate Current .....	1.3	mA
Grid-No.2 Current .....	2	mA
Grid-No.1 Voltage (Approx.) for plate current of 10 $\mu$ A .....	-4.5	volts
Grid-No.3 Voltage (Approx.) for plate current of 10 $\mu$ A .....	-4.5	volts

**Pentode Unit as FM Sound Detector**

**MAXIMUM RATINGS (Design-Maximum Values)**

Plate Voltage .....	330	volts
Grid-No.3 Voltage .....	28	volts
Grid No.2 Supply Voltage .....	330	volts
Grid-No.2 Voltage .....	See curve page 96	
Grid-No.1 (Control-Grid) Voltage, Positive-bias value .....	0	volts
Plate Dissipation .....	1.7	watts
Grid-No.2 Input:		
For grid-No.2 voltages up to 165 volts .....	1.1	watts
For grid-No.2 voltages between 165 and 330 volts .....	See curve page 96	

**MAXIMUM CIRCUIT VALUE**

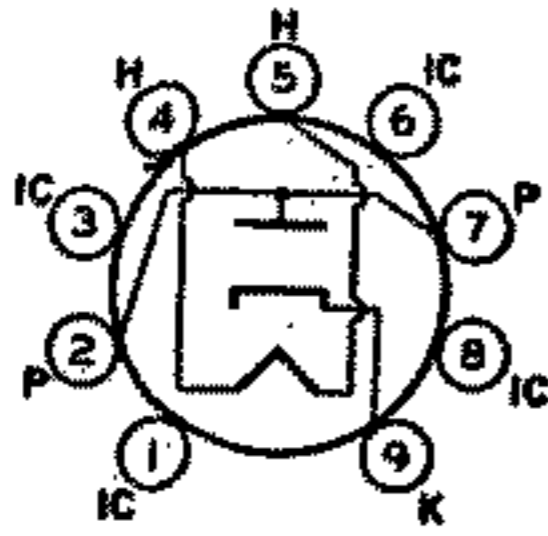
Grid-No.1-Circuit Resistance:		
For fixed-bias operation .....	0.25	megohm
For cathode-bias operation .....	0.5	megohm

**6BG6G**

**6BG6GA**

Refer to chart at end of section.





**9HP**

**HALF-WAVE  
VACUUM RECTIFIER**

**6BH3  
6BH3A**

17BH3, 17BH3A,  
22BH3, 22BH3A

Novar types used as damper tubes in horizontal-deflection circuits of black-and-white television receivers. Outlines section, 11D and 30B, respectively; require novar 9-contact socket. Socket terminals 1, 3, 6, and 8 should not be used as tie points. These tubes, like other power-handling tubes, should be adequately ventilated. Types 17BH3 and 17BH3A and types 22BH3 and 22BH3A are identical with types 6BH3 and 6BH3A, except for heater ratings.

	6BH3 6BH3A	17BH3 17BH3A	22BH3 22BH3A	
Heater Voltage (ac/dc)	6.3	17	22.4	volts
Heater Current	1.6	0.6	0.45	amperes
Heater Warm-up Time (Average)	—	11	11	seconds
Direct Interelectrode Capacitances (Approx.):				
Plate to Cathode and Heater			6.5	pF
Cathode to Plate and Heater			9.0	pF
Heater to Cathode			2.8	pF

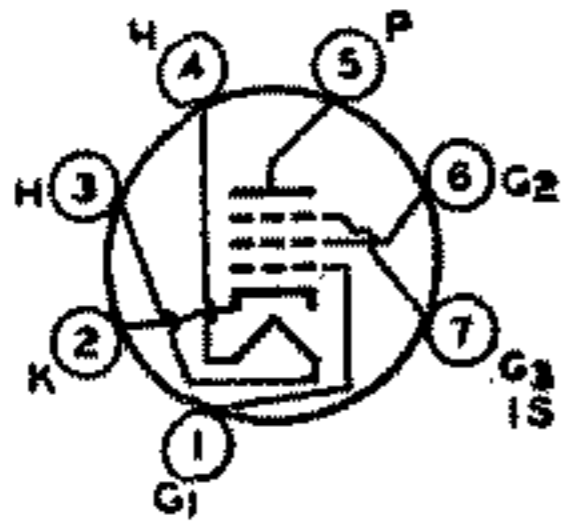
**Damper Service**

For operation in a 525-line, 30-frame system

**MAXIMUM RATINGS (Design-Maximum Values)**

Peak Inverse Plate Voltage#		5500	volts
Peak Plate Current		1100	mA
Average Plate Current		180	mA
Plate Dissipation		6.5	watts
Heater-Cathode Voltage:			
Peak value	+300	—5500	volts
Average value	+100	—900	volts

# Pulse duration must not exceed 15% of a horizontal scanning cycle (10 microseconds).



**7CM**

**SHARP-CUTOFF PENTODE**

**6BH6**

Miniature type used as rf amplifier particularly in ac/dc receivers and in mobile equipment where low heater-current drain is important. It is particularly useful in high-frequency, wide-band applications. Outlines section, 5C; requires miniature 7-contact socket.

Heater Voltage (ac/dc)	6.3	volts
Heater Current	0.15	ampere
Peak Heater-Cathode Voltage	±90 max	volts
Direct Interelectrode Capacitances:*		
Grid No.1 to Plate	0.0035 max	pF
Grid No.1 to Cathode, Heater, Grid No.2, Grid No.3, and Internal Shield	5.4	pF
Plate to Cathode, Heater, Grid No.2, Grid No.3, and Internal Shield	4.4	pF

\* Without external shield, or with external shield connected to cathode.

**Class A<sub>1</sub> Amplifier**

**MAXIMUM RATINGS (Design-Center Values)**

Plate Voltage	300	volts
Grid-No.2 (Screen-Grid) Voltage	See curve page 96	
Grid-No.2 Supply Voltage	300	volts
Grid-No.1 (Control-Grid) Voltage:		
Negative-bias value	—50	volts
Positive-bias value	0	volts

Plate Dissipation .....	3	watts
Grid-No.2 Input:		
For grid-No.2 voltages up to 150 volts .....	0.5	watt
For grid-No.2 voltages between 150 and 300 volts .....		See curve page 96

**CHARACTERISTICS**

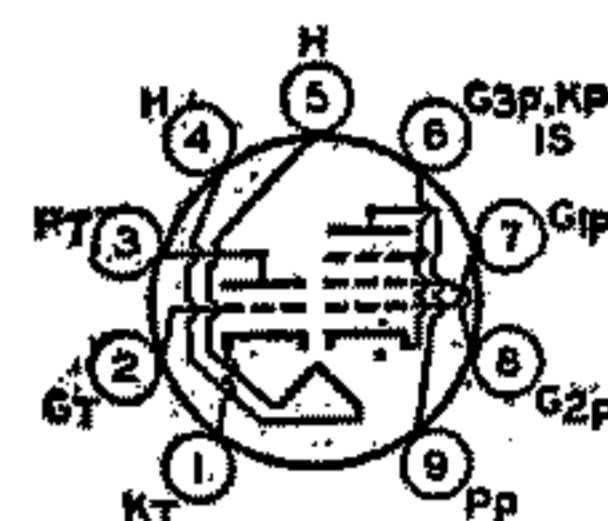
Plate Voltage .....	100	250	volts
Grid No.3 .....	Connected to cathode at socket		
Grid-No.2 Voltage .....	100	150	volts
Grid-No.1 Voltage .....	-7	-7	volt
Plate Resistance (Approx.) .....	0.7	1.4	megohms
Transconductance .....	3400	4600	μmhos
Plate Current .....	3.6	7.4	mA
Grid-No.2 Current .....	1.4	2.9	mA
Grid-No.1 Voltage (Approx.) for plate current of 10 μA .....	-5	-7.7	volts

**6BH8**

8BH8

**MEDIUM-MU TRIODE SHARP-CUTOFF PENTODE**

Miniature type used in color and black-and-white television receiver applications. The pentode unit is used as an if amplifier, video amplifier, or agc amplifier. The triode unit is used in low-frequency oscillator circuits. Outlines section, 6E; requires miniature 9-contact socket. Type 8BH8 is identical with type 6BH8 except for heater ratings.

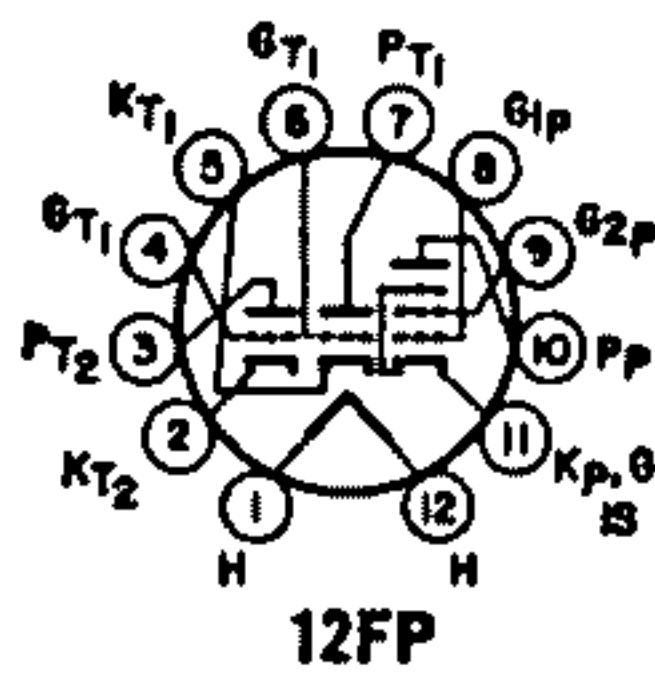


Heater Voltage (ac/dc) .....	6.3	8.4	volts
Heater Current .....	0.6	0.45	ampere
Heater Warm-up Time (Average) .....	11	—	seconds
Heater-Cathode Voltage:			
Peak value .....	±200 max	±200 max	volts
Average value .....	100 max	100 max	volts
Direct Interelectrode Capacitances (Approx.):			
Triode Unit:			
Grid to Plate .....		2.4	pF
Grid to Cathode and Heater .....		2.6	pF
Plate to Cathode and Heater .....		0.38	pF
Pentode Unit:			
Grid No.1 to Plate .....		0.046	pF
Grid No.1 to Cathode, Heater, Grid No.2, Grid No.3, and Internal Shield .....		7	pF
Plate to Cathode, Heater, Grid No.2, Grid No.3, and Internal Shield .....		2.4	pF
Triode Grid to Pentode Plate .....		0.016	pF
Pentode Grid No.1 to Triode Plate .....		0.004	pF
Pentode Plate to Triode Plate .....		0.095	pF

**Class A<sub>1</sub> Amplifier**

<b>MAXIMUM RATINGS (Design-Center Values)</b>	<b>Triode Unit</b>	<b>Pentode Unit</b>	
Plate Voltage .....	300	300	volts
Grid-No.2 (Screen-Grid) Supply Voltage .....	—	300	volts
Grid-No.2 Voltage .....	—	See curve page 96	
Grid-No.1 (Control-Grid) Voltage, Positive-bias value .....	0	0	volts
Plate Dissipation .....	2.5	3	watts
Grid-No.2 Input:			
For grid-No.2 voltages up to 150 volts .....	—	1	watt
For grid-No.2 voltages between 150 and 300 volts .....	—	See curve page 96	
<b>CHARACTERISTICS</b>			
Plate Supply Voltage .....	150	200	volts
Grid-No.2 Supply Voltage .....	—	125	volts
Grid-No.1 Voltage .....	-5	—	volts
Cathode-Bias Resistor .....	—	82	ohms
Amplification Factor .....	17	—	
Plate Resistance (Approx.) .....	5150	150000	ohms
Transconductance .....	3300	7000	μmhos
Plate Current .....	9.5	15	mA
Grid-No.2 Current .....	—	3.4	mA
Grid-No.1 Voltage (Approx.) for plate current of 100 μA .....	-14	-8	volts
<b>MAXIMUM CIRCUIT VALUES</b>			
Grid-No.1-Circuit Resistance:			
For fixed-bias operation .....	0.5	0.25	megohm
For cathode-bias operation .....	1.0	1.0	megohm

## MEDIUM-MU TWIN TRIODE SHARP-CUTOFF PENTODE 6BH11



Duodecar type used in color and black-and-white television receiver applications. The triode units are used for general-purpose applications, and the pentode unit is used for horizontal-deflection service. Outlines section, 8B; requires duodecar 12-contact socket. Heater: volts (ac/dc), 6.3; amperes, 0.8; maximum heater-cathode volts,  $\pm 200$  peak, 100 average.

### Pentode Unit as Horizontal-Deflection Oscillator

**MAXIMUM RATINGS (Design-Maximum Values)**

Plate Voltage .....	350	volts
Grid-No.2 (Screen-Grid) Voltage .....	330	volts
Grid-No.1 (Control-Grid) Voltage:		
Positive-bias value .....	0	volts
Peak negative value .....	-175	volts
Peak Cathode Current .....	300	mA
Average Cathode Current .....	20	mA
Plate Dissipation .....	2.5	watts
Grid-No.2 Input .....	0.55	watt

### Class A<sub>1</sub> Amplifier

**MAXIMUM RATINGS (Design-Maximum Values)**

	<b>Each Triode Unit</b>	
Plate Voltage .....	330	volts
Grid Voltage, Positive-bias Value .....	0	volts
Plate Dissipation .....	2.5	watts

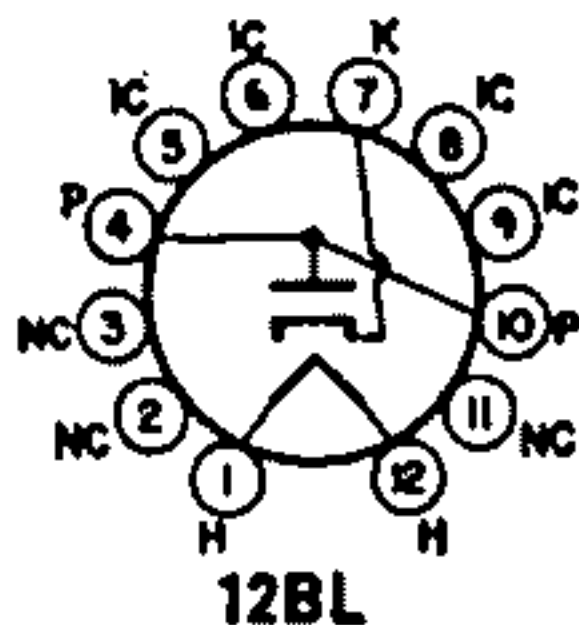
**CHARACTERISTICS**

	<b>Pentode Unit</b>	<b>Each Triode Unit</b>	
Plate Voltage .....	125	125	volts
Grid-No.2 Voltage .....	125	—	volts
Grid-No.1 Voltage .....	-1	-1	volt
Amplification Factor .....	—	46	
Plate Resistance (Approx.) .....	200000	5400	ohms
Transconductance .....	7500	8500	$\mu$ mhos
Plate Current .....	12	13.5	mA
Grid-No.2 Current .....	4	—	mA
Grid-No.1 Voltage (Approx.) for plate current of 10 $\mu$ A .....	-8	-8	volts

**MAXIMUM CIRCUIT VALUES**

Grid-No.1-Circuit Resistance:			
For fixed-bias operation .....	2.2	2.2	megohms
For cathode-bias operation .....	2.2	2.2	megohms

## HALF-WAVE VACUUM RECTIFIER 6BJ3



Duodecar type used as damper tube in horizontal-deflection circuits of black-and-white television receivers. Outlines section, 8C; requires duodecar 12-contact socket. Socket terminals 5, 6, 8, and 9 should not be used as tie points. This tube, like other power-handling tubes, should be adequately ventilated. Heater: volts (ac/dc), 6.3; amperes, 1.2.

### Damper Service

For operation in a 525-line, 30-frame system

**MAXIMUM RATINGS (Design-Maximum Values)**

Peak Inverse Plate Voltage <sup>#</sup> .....	3300	volts	
Peak Plate Current .....	840	mA	
Average Plate Current .....	140	mA	
Plate Dissipation .....	4	watts	
Heater-Cathode Voltage:			
Peak value .....	+300	-3300	volts
Average value .....	+100	-600	volts

**CHARACTERISTICS, Instantaneous Value**

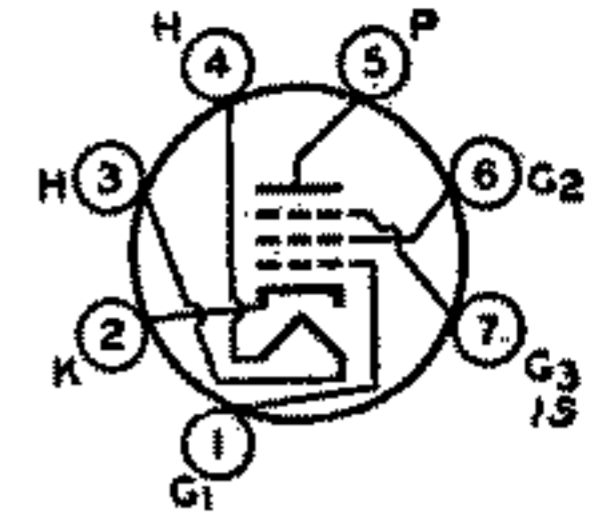
Tube Voltage Drop for plate current of 250 mA .....	21	volts
---	----	-------

<sup>#</sup> Pulse duration must not exceed 15% of a horizontal scanning cycle (10 microseconds).



## 6BJ6 REMOTE-CUTOFF PENTODE

Miniature type used as rf amplifier in high-frequency and wide-band applications. Features high transconductance and low grid-to-plate capacitance. Outlines section, 5C; requires miniature 7-contact socket.



7CM

Heater Voltage (ac/dc) .....	6.3	volts
Heater Current .....	0.15	ampere
Peak Heater-Cathode Voltage .....	±90 max	volts
Direct Interelectrode Capacitances:		
Grid No.1 to Plate .....	0.0035 max	pF
Grid No.1 to Cathode, Heater, Grid No.2, Grid No.3, and Internal Shield .....	4.5	pF
Plate to Cathode, Heater, Grid No.2, Grid No.3, and Internal Shield .....	5.5	pF

• Without external shield, or with external shield connected to cathode.

### Class A<sub>1</sub> Amplifier

#### MAXIMUM RATINGS (Design-Center Values)

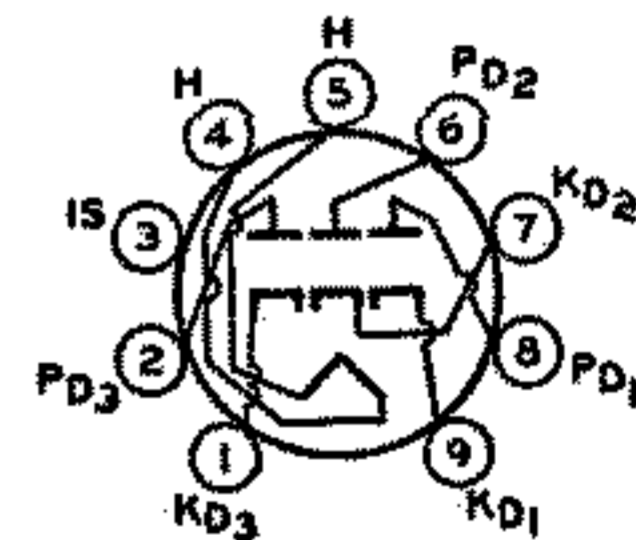
Plate Voltage .....	300	volts
Grid-No.2 (Screen-Grid) Voltage .....	See curve page 96	
Grid-No.2 Supply Voltage .....	300	volts
Plate Dissipation .....	3	watts
Grid-No.2 Input:		
For grid-No.2 voltages up to 150 volts .....	0.6	watt
For grid-No.2 voltages between 150 and 300 volts .....	See curve page 96	
Grid-No.1 (Control-Grid) Voltage:		
Negative-bias value .....	-50	volts
Positive-bias value .....	0	volts

#### CHARACTERISTICS

Plate Voltage .....	100	250	volts
Grid No.3 .....	Connected to cathode at socket		
Grid-No.2 Voltage .....	100	100	volts
Grid-No.1 Voltage .....	-1.0	-1.0	volt
Plate Resistance (Approx.) .....	0.25	1.3	megohms
Transconductance .....	3650	3600	μmhos
Plate Current .....	9.0	9.2	mA
Grid-No.2 Current .....	3.5	3.3	mA
Grid-No.1 Voltage (Approx.) for transconductance of 10 μmhos .....	-20	-20	volts

## 6BJ7 TRIPLE DIODE

Miniature type used as a dc-restorer tube in each of the three signal channels of color-television receivers. Each diode has a separate cathode. Outlines section, 6B; requires miniature 9-contact socket.



9AX

Heater Voltage .....	6.3	volts
Heater Current .....	0.45	ampere
Direct Interelectrode Capacitances:		
Plate of Unit No.1 to Cathode of Unit No.1, Heater, and Internal Shield .....	3	pF
Plate of Unit No.2 to Cathode of Unit No.2, Heater, and Internal Shield .....	2.6	pF
Plate of Unit No.3 to Cathode of Unit No.3, Heater, and Internal Shield .....	2.6	pF
Cathode of Unit No.1 to Plate of Unit No.1, Heater, and Internal Shield .....	4	pF
Cathode of Unit No.2 to Plate of Unit No.2, Heater, and Internal Shield .....	3.8	pF
Cathode of Unit No.3 to Plate of Unit No.3, Heater, and Internal Shield .....	4	pF
Plate of Unit No.1 to Plate of Unit No.2 .....	0.055	pF
Plate of Unit No.2 to Plate of Unit No.3 .....	0.036	pF
Plate of Unit No.3 to Plate of Unit No.1 .....	0.036	pF

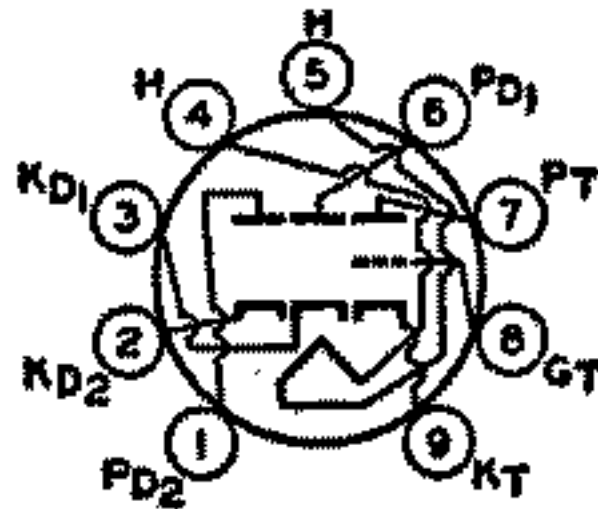
DC Restorer Service

MAXIMUM RATINGS (Design-Center Values, Each Unit)

Peak Inverse Plate Voltage .....	330	volts
Peak Plate Current .....	10	mA
Average Output Current .....	1	mA
Peak Heater-Cathode Voltage .....	+100      -330	volts

TWIN DIODE—  
MEDIUM-MU TRIODE

6BJ8



9ER

Miniature type used in black-and-white and color television receiver applications. The diode units are used in phase-detector, phase-comparator, ratio-detector or discriminator, and horizontal afc discriminator circuits. The triode unit is used in phase-splitter, audio-frequency amplifier, vertical-deflection amplifier, and low-frequency oscillator applications. Outlines section, 6E; requires miniature 9-contact socket.

Heater Voltage (ac/dc) .....	6.3	volts
Heater Current .....	0.6	ampere
Heater Warm-up Time (Average) .....	11	seconds
Heater-Cathode Voltage:		
Peak value .....	±200 max	volts
Average value .....	100 max	volts
Direct Interelectrode Capacitances:		
Triode Unit:		
Grid to Plate .....	2.6	pF
Grid to Cathode and Heater .....	2.8	pF
Plate to Cathode and Heater .....	0.31	pF
Diode Units:		
Plate to Cathode and Heater (Each Unit) .....	1.9	pF
Cathode to Plate and Heater (Each Unit) .....	4.6	pF
Plate of Unit No.1 to Plate of Unit No.2 .....	0.06 max	pF
Plate of Diode Unit No.1 to Triode Grid .....	0.07 max	pF
Plate of Diode Unit No.2 to Triode Grid .....	0.11 max	pF
Plate of Either Diode Unit to All Other Electrodes .....	3.0	pF
Cathode of Either Diode Unit to All Other Electrodes .....	4.8	pF

Triode Unit as Class A<sub>1</sub> Amplifier

MAXIMUM RATINGS (Design-Maximum Values)

Plate Voltage .....	330	volts
Grid Voltage, Positive-bias value .....	0	volts
Average Cathode Current .....	22	mA
Plate Dissipation .....	4	watts

CHARACTERISTICS

Plate Voltage .....	90	250	volts
Grid Voltage .....	0	-9	volts
Amplification Factor .....	22	20	
Plate Resistance (Approx.) .....	4700	7150	ohms
Transconductance .....	4700	2800	μmhos
Plate Current .....	13.5	8	mA
Plate Current for grid voltage of -12.5 volts .....	—	1.7	mA
Grid Voltage (Approx.) for plate current of 10 μA ..	-7	-18	volts

MAXIMUM CIRCUIT VALUE

Grid-Circuit Resistance .....	1	megohm
-------------------------------	---	--------

Triode Unit as Vertical-Deflection Amplifier

For operation in a 525-line, 30-frame system

MAXIMUM RATINGS (Design-Maximum Values)

DC Plate Voltage .....	330	volts
Peak Positive-Pulse Plate Voltage# .....	1200	volts
Peak Negative-Pulse Grid Voltage .....	-275	volts
Peak Cathode Current .....	77	mA
Average Cathode Current .....	22	mA
Plate Dissipation .....	4	watts

MAXIMUM CIRCUIT VALUE

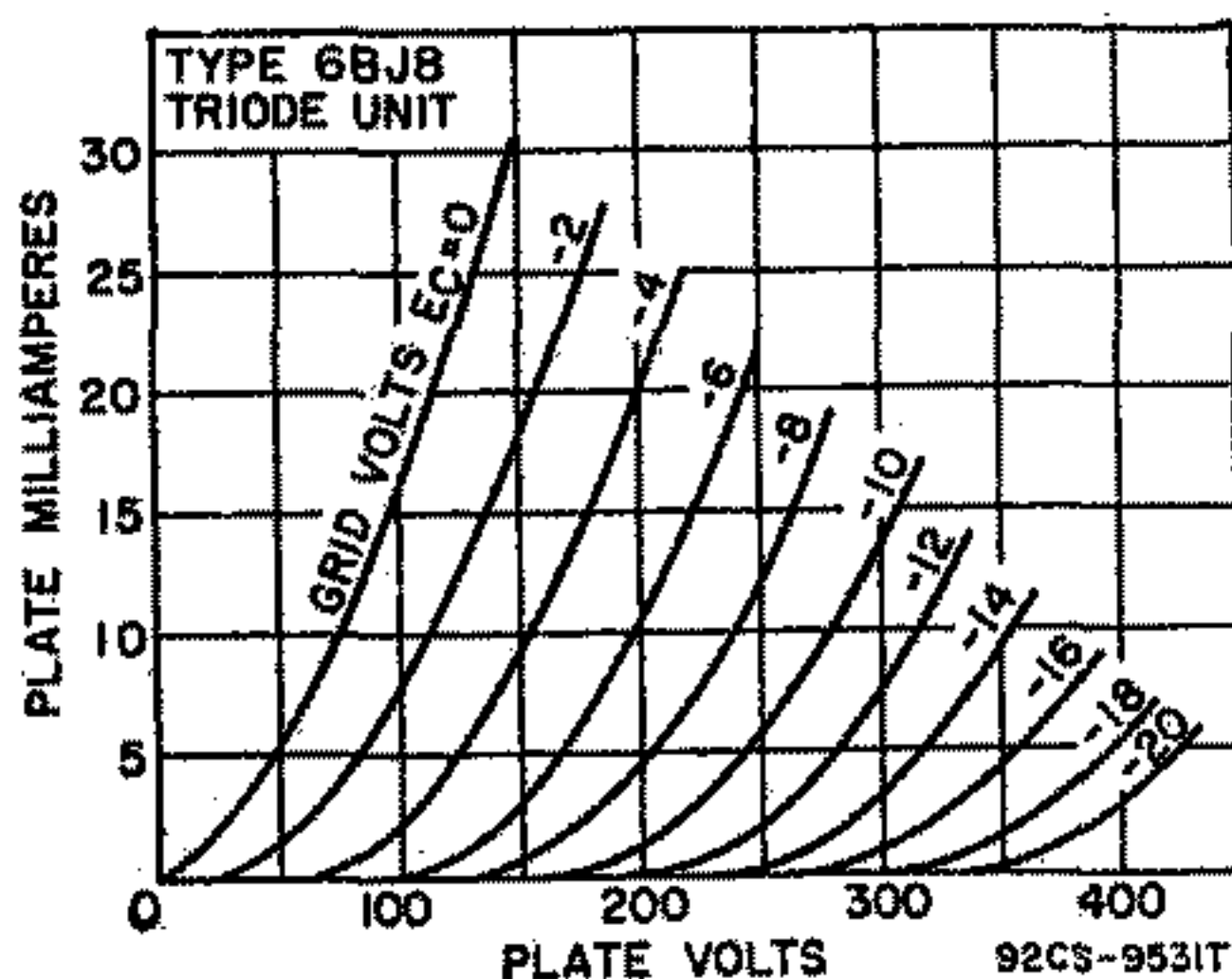
Grid-Circuit Resistance, for cathode-bias operation .....	2.2	megohms
---	-----	---------

# Pulse duration must not exceed 15% of a vertical scanning cycle (2.5 milliseconds).

Diode Units

MAXIMUM RATINGS (Design-Maximum Values)

Plate Current (Each Unit):		
Peak .....	54	mA
Average .....	9	mA



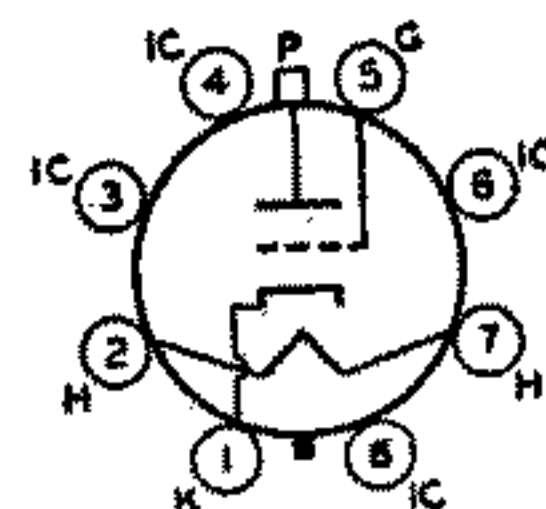
6BK4

Refer to chart at end of section.

**6BK4A**  
**6BK4B**

**SHARP-CUTOFF**  
**BEAM TRIODE**

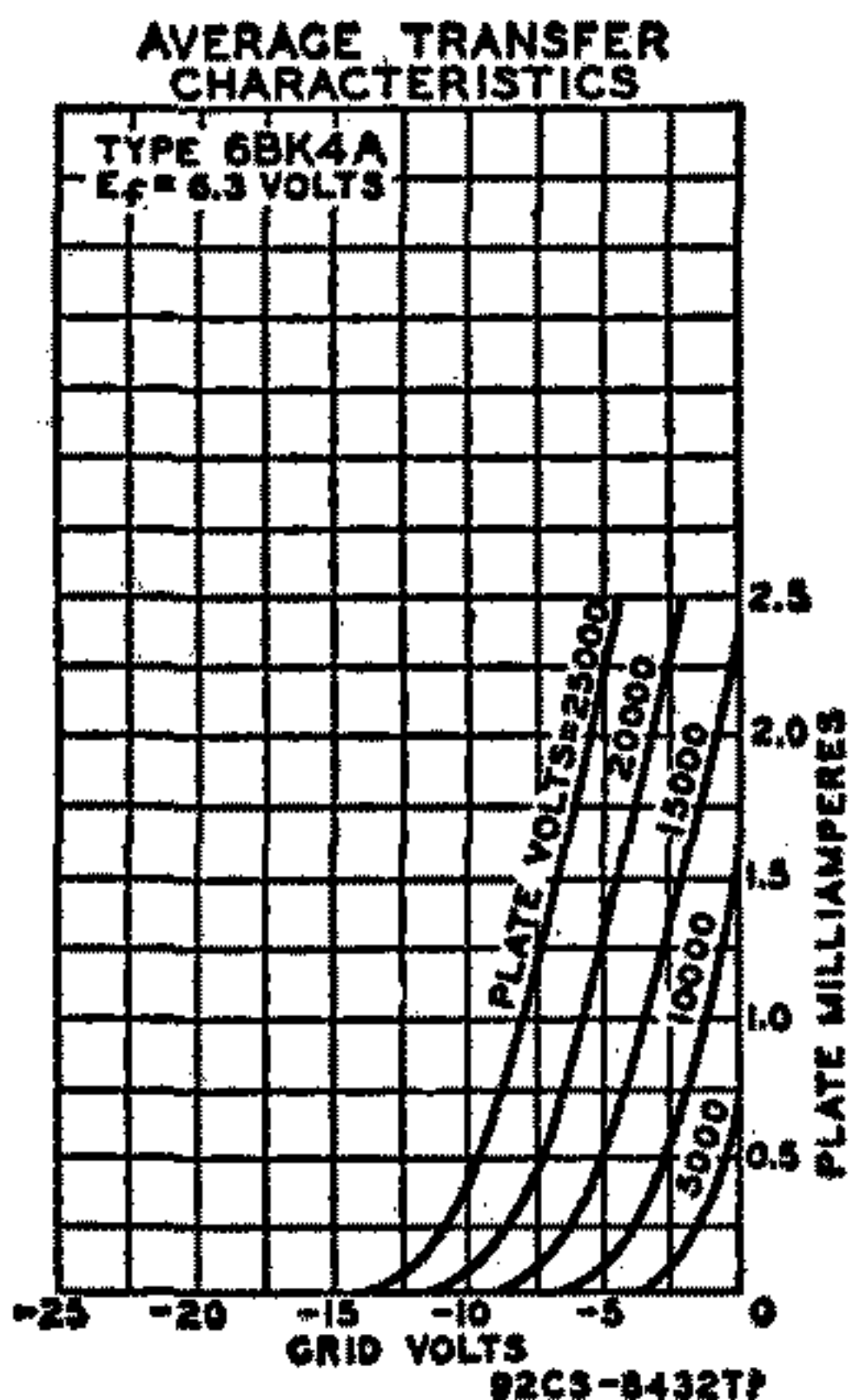
Glass octal types used for the voltage regulation of high-voltage, low-current dc power supplies in color and black-and-white television receivers. Outlines section, 21B; require octal socket. Type 6BK4B is identical with type 6BK4A except for a higher plate dissipation and peak heater-cathode voltage.



8GC

Heater Voltage (ac/dc) .....	6BK4A	6.3	volts
Heater Current .....	6BK4B	0.2	ampere
Peak Heater-Cathode Voltage .....	—200	—450*max	volts

6.3	volts
0.2	ampere
—450*max	volts





Direct Interelectrode Capacitances (Approx.):

Grid to Plate .....	0.03	pF
Grid to Cathode and Heater .....	2.6	pF
Plate to Cathode and Heater .....	1	pF
Amplification Factor (Approx.) .....	2000	

\* Series impedance should be used with the cathode to limit the cathode current under prolonged short-circuit conditions to 450 mA.

Voltage-Control Service

MAXIMUM RATINGS (Design-Maximum Values)

DC Plate Voltage .....	27000	volts
Unregulated DC Supply Voltage .....	60000	volts
DC Grid Voltage .....	-135	volts
Peak Grid Voltage* .....	-440	volts
Average Plate Current .....	1.6	mA
Plate Dissipation (6BK4A) .....	30	watts
Plate Dissipation (6BK4B) .....	40	watts

MAXIMUM CIRCUIT VALUE

Grid-Circuit Resistance:		
For use with "Flyback Transformer" high-voltage supply ....	3	megohms

\* For interval of 20 seconds maximum duration during equipment warm-up period.

Refer to chart at end of section.

**6BK5**

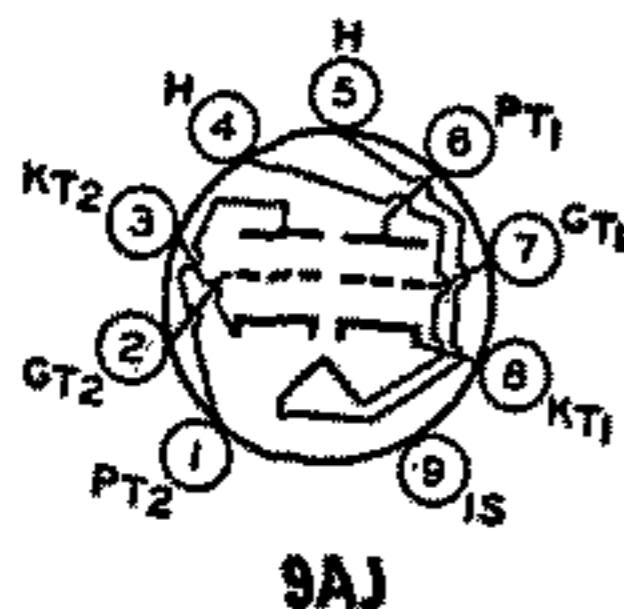
Refer to chart at end of section.

**6BK7A**

MEDIUM-MU TWIN TRIODE

**6BK7B**

**5BK7A**



Miniature type used as a cascode amplifier in vhf color and black-and-white television tuners and in push-pull cathode-drive rf amplifiers. Outlines section, 6B; requires miniature 9-contact socket. For typical operation as a resistance-coupled amplifier, refer to Resistance-Coupled Amplifier section. Type 5BK7A is identical with type 6BK7B except for heater ratings.

	5BK7A	6BK7B	
Heater Voltage (ac/dc) .....	4.7	6.3	volts
Heater Current .....	0.6	0.45	ampere
Heater Warm-up Time (Average) .....	11	11	seconds
Heater-Cathode Voltage:			
Peak value .....	±200*max	±200*max	volts
Average value .....	100 max	100 max	volts
Direct Interelectrode Capacitances:	Unit No.1	Unit No.2	
Grid to Plate .....	1.8	1.8	pF
Grid to Cathode, Heater, and Internal Shield ..	3	3	pF
Plate to Cathode, Heater, and Internal Shield ..	1	0.9	pF
Cathode to Grid, Heater, and Internal Shield ..	6	6	pF
Plate to Grid, Heater, and Internal Shield ....	2.4	2.4	pF
Plate to Cathode .....	0.22	0.22	pF
Heater to Cathode .....	2.8	3	pF
Grid of Unit No.1 to Grid of Unit No.2 .....		0.004 max	pF
Plate of Unit No.1 to Plate of Unit No.2 .....		0.075 max	pF

\* Rating may be as high as 300 volts under cutoff conditions when tube is used as a cascode amplifier, the units are connected in series, and heater is negative with respect to cathode.

Class A<sub>1</sub> Amplifier (Each Unit)

MAXIMUM RATINGS (Design-Center Value)

Plate Voltage .....	300	volts
Grid Voltage, Negative-bias value .....	-50	volts
Plate Dissipation .....	2.7	watts

CHARACTERISTICS

Plate Supply Voltage .....	150	volts
Cathode-Bias Resistor .....	56	ohms
Amplification Factor .....	43	
Plate Resistance (Approx.) .....	4600	ohms
Transconductance .....	9300	μmhos
Plate Current .....	18	mA
Grid Voltage (Approx.) for plate current of 10 μA .....	-11	volts

Refer to chart at end of section.

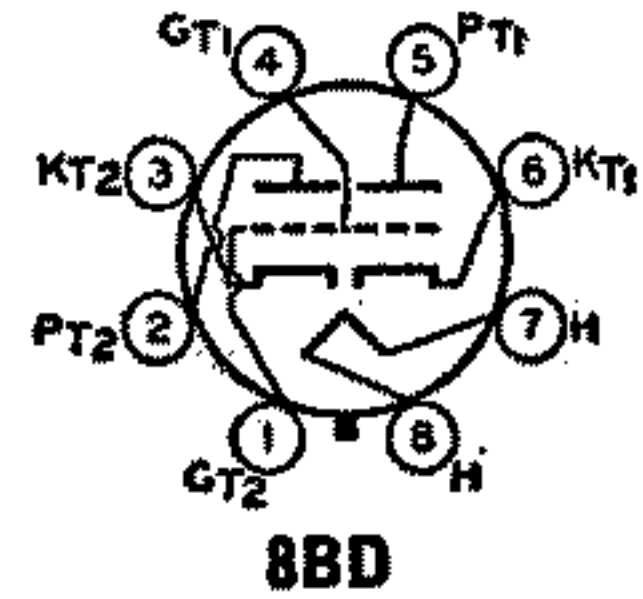
**6BL4**

**6BL7GT**

Refer to chart at end of section.

**6BL7GTA MEDIUM-MU TWIN TRIODE**

Glass octal type used as combined vertical-deflection amplifier and vertical-deflection oscillator in color and black-and-white television receivers. When so operated, it is recommended that unit No.1 (pins 4, 5, and 6) be used as the oscillator. Outlines section, 13D; requires octal socket.



Heater Voltage (ac/dc)	6.3	volts	
Heater Current	1.5	amperes	
Heater-Cathode Voltage:			
Peak value	±200 max	volts	
Average value	100 max	volts	
Direct Interelectrode Capacitances (Approx.):	Unit No. 1	Unit No. 2	
Grid to Plate	6	6	pF
Grid to Cathode and Heater	4.2	4.6	pF
Plate to Cathode and Heater	0.9	0.9	pF

**Class A<sub>1</sub> Amplifier**

**CHARACTERISTICS (Each Unit)**

Plate Voltage	150	250	250	volts
Grid Voltage	0	-17	-9	volts
Amplification Factor	—	—	15	
Plate Resistance (Approx.)	—	—	2150	ohms
Transconductance	—	—	7000	μmhos
Plate Current	65*	4	40	mA
Grid Voltage (Approx.) for plate current of 50 μA	—	—	-23	volts

\* This value can be measured by a method involving a recurrent waveform such that the maximum ratings of the tube will not be exceeded.

**Vertical-Deflection Oscillator or Amplifier\***

For operation in a 525-line, 30-frame system

<b>MAXIMUM RATINGS (Design-Center Values)</b>	<b>Oscillator</b>	<b>Amplifier</b>	
DC Plate Voltage	500	500	volts
Peak Positive-Pulse Plate Voltage# (Absolute Maximum)	—	2000 <sup>Δ</sup>	volts
Peak Negative-Pulse Grid Voltage	-400	-250	volts
Peak Cathode Current	210	210	mA
Average Cathode Current	60	60	mA
Plate Dissipation:			
For either plate	10	10	watts
For both plates with both units operating	12	12	watts

**MAXIMUM CIRCUIT VALUES**

Grid-Circuit Resistance	4.7	4.7†	megohms
-------------------------	-----	------	---------

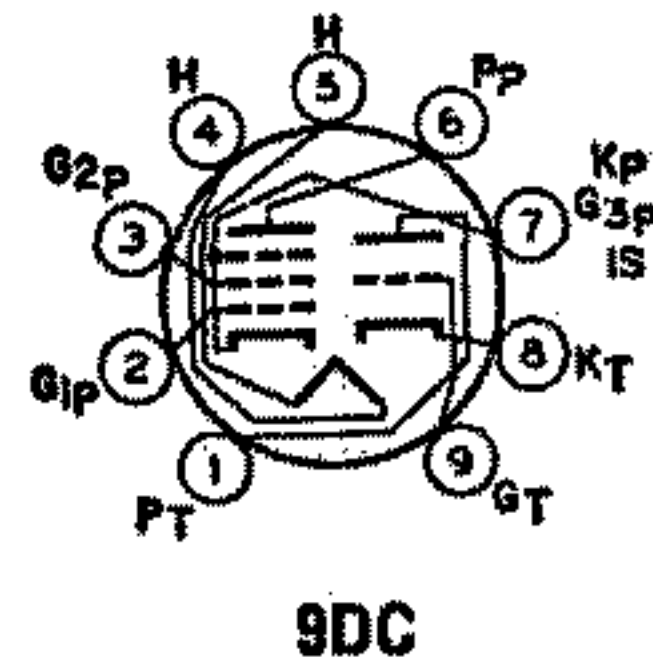
- \* Unless otherwise specified, values are for each unit.
- # Pulse duration must not exceed 15% of a vertical scanning cycle (2.5 milliseconds).
- Δ Under no circumstances should this absolute value be exceeded.
- † For cathode-bias operation.

**6BL8  
6BL8/  
ECF80**

4BL8, 4BL8/XCF80

**MEDIUM-MU TRIODE—  
SHARP-CUTOFF PENTODE**

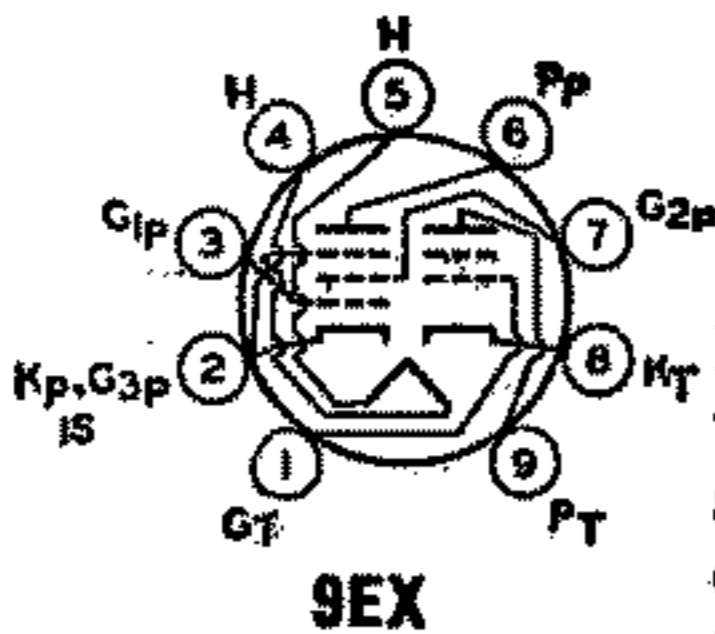
Miniature types used in frequency-changer service in color and black-and-white television receivers. Outlines section, 6B; require miniature 9-contact socket. Types 4BL8/XCF80 and 6BL8/ECF80 are identical with types 4BL8 and 6BL8, respectively. Type 4BL8 is identical with type 6BL8 except for heater ratings.



	<b>4BL8</b>	<b>6BL8</b>	
	<b>4BL8/ XCF80</b>	<b>6BL8/ ECF80</b>	
Heater Voltage (ac/dc) .....	4.6	6.3	volts
Heater Current .....	0.6	0.45	ampere
Peak Heater-Cathode Voltage .....	±100 max	±100 max	volts

**Class A Amplifier**

<b>MAXIMUM RATINGS (Design-Center Values)</b>	<b>Triode Unit</b>	<b>Pentode Unit</b>	
Plate Supply Voltage .....	550	550	volts
Plate Voltage .....	250	250	volts
Grid-No.2 (Screen-Grid) Supply Voltage .....	—	550	volts
Grid-No.2 Voltage:			
With cathode current of 14 mA .....	—	175	volts
With cathode current less than 10 mA .....	—	200	volts
Cathode Current .....	14	14	mA
Plate Dissipation .....	1.5	1.7	watts
Grid-No.2 Input:			
With plate dissipation greater than 1.2 watts ..	—	0.5	watt
With plate dissipation less than 1.2 watts .....	—	0.75	watt
<b>CHARACTERISTICS</b>			
Plate Voltage .....	100	170	volts
Grid-No.2 Input:	—	170	volts
Grid-No.1 Voltage .....	—2	—2	volts
Amplification Factor .....	20	—	
Mu-Factor, Grid No.2 to Grid No.1 .....	—	47	
Plate Resistance (Approx.) .....	—	0.4	megohm
Transconductance .....	5000	6200	μmhos
Plate Current .....	14	10	mA
Grid-No.2 Current .....	—	2.8	mA
Input Resistance at frequency of 50 MHz .....	—	0.01	megohm
Equivalent Noise Resistance .....	—	1500	ohms
<b>MAXIMUM CIRCUIT VALUES</b>			
Grid-No.1-Circuit Resistance:			
For fixed-bias operation .....	0.5	0.5	megohm
For cathode-bias operation .....	0.5	1	megohm



**HIGH-MU TRIODE  
POWER PENTODE**

**6BM8/  
ECL82**

Miniature type used in color and black-and-white television receiver applications. The pentode unit is used as an audio output tube, and the triode unit as an oscillator and af voltage amplifier. Outlines section, 6G; requires miniature 9-contact socket. Heater: volts (ac/dc), 6.3; amperes, 0.78; maximum heater-cathode volts, 100 peak.

**Class A Amplifier**

<b>MAXIMUM RATINGS (Design-Center Values)</b>	<b>Triode Unit</b>	<b>Pentode Unit</b>	
Plate Supply Voltage .....	550	900	volts
Plate Voltage .....	300	600	volts
Grid-No.2 Supply Voltage .....	—	550	volts
Grid-No.2 Voltage .....	—	300	volts
Cathode Current .....	15	50	mA
Plate Dissipation .....	1	7	watts
Grid-No.2 Input .....	—	1.8	watts
<b>CHARACTERISTICS</b>			
Plate Voltage .....	100	200	volts
Grid-No.2 Voltage .....	—	200	volts
Grid-No.1 Voltage .....	0	—16	volts
Amplification Factor .....	70	9.5*	
Plate Resistance (Approx.) .....	—	0.02	megohm
Transconductance .....	2500	6400	μmhos
Plate Current .....	3.5	95	mA
Grid-No.2 Current .....	—	7	mA
<b>MAXIMUM CIRCUIT VALUES</b>			
Grid-No.1-Circuit Resistance:			
For fixed-bias operation .....	1	1	megohm
For cathode-bias operation .....	2	2	megohms

\* Grid No.2 to Grid No.1



**6BN4**

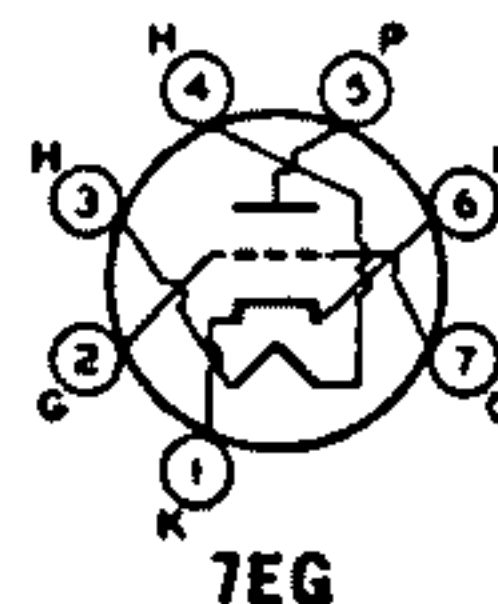
Refer to chart at end of section.

**6BN4A**

2BN4A, 3BN4A

**MEDIUM-MU TRIODE**

Miniature type used as rf amplifier tube in grid-drive circuits of vhf color and black-and-white television tuners. Outlines section, 5C; requires miniature 7-contact socket. Types 2BN4A and 3BN4A are identical with type 6BN4A except for heater ratings.



	2BN4A	3BN4A	6BN4A	
Heat Voltage (ac/dc) .....	2.35	3	6.3	volts
Heater Current .....	0.6	0.45	0.2	ampere
Heater Warm-up Time (Average) .....	11	11	—	seconds
Peak Heater-Cathode Voltage .....	±100 max	±100 max	±100 max	volts
Direct Interelectrode Capacitances (Approx.):*				
Grid to Plate .....			1.2	pF
Grid to Cathode and Heater .....			3.2	pF
Plate to Cathode and Heater .....			1.4	pF

\* With external shield connected to cathode.

**Class A<sub>1</sub> Amplifier**

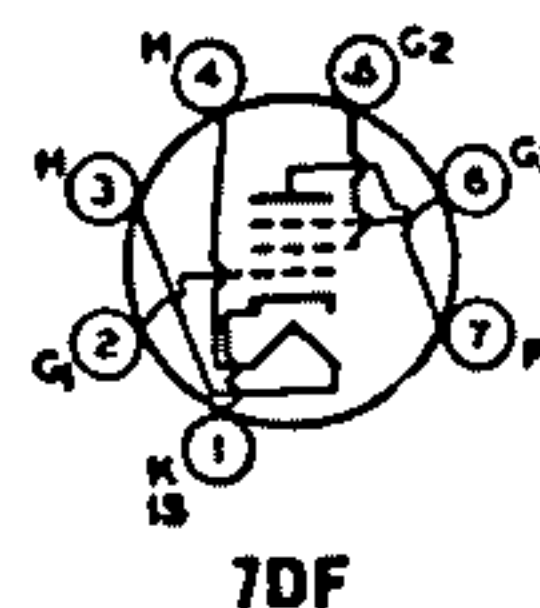
MAXIMUM RATINGS (Design-Center Values)			
Plate Voltage .....	275		volts
Grid Voltage, Positive-bias value .....	0		volts
Cathode Current .....	22		mA
Plate Dissipation .....	2.2		watts
CHARACTERISTICS			
Plate-Supply Voltage .....	150		volts
Cathode-Bias Resistor .....	220		ohms
Amplification Factor .....	43		
Plate Resistance (Approx.) .....	5400		ohms
Transconductance .....	7700		μmhos
Plate Current .....	9		mA
Grid Voltage (Approx.) for plate current of 100 μA .....	-6		volts
MAXIMUM CIRCUIT VALUE			
Grid-Circuit Resistance .....	0.5		megohm

**6BN6**

3BN6, 4BN6  
12BN6

**BEAM TUBE**

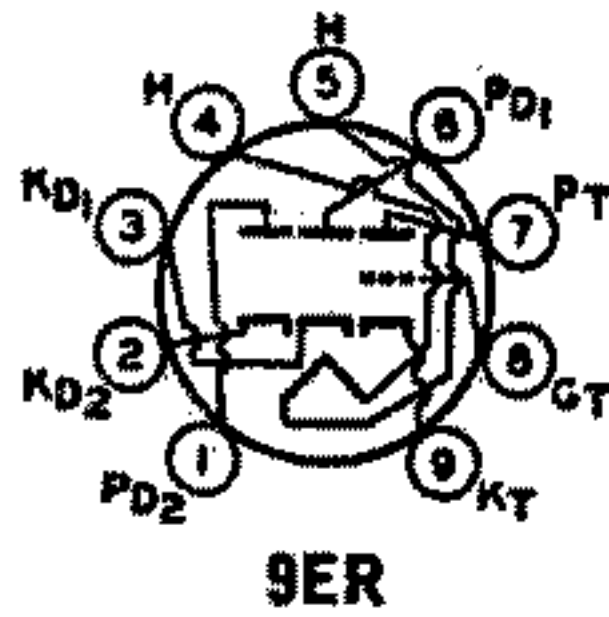
Miniature type used as combined limiter, discriminator, and audio-voltage amplifier in intercarrier television and FM receivers. Outlines section, 5D; requires miniature 7-contact socket. Types 3BN6, 4BN6, and 12BN6 are identical with type 6BN6 except for heater ratings.



	3BN6	4BN6	6BN6	12BN6	
Heater Voltage (ac/dc) .....	3.15	4.2	6.3	12.6	volts
Heater Current .....	0.6	0.45	0.3	0.15	ampere
Heater Warm-up Time (Average) .....	11	11	—	—	seconds
Heater-Cathode Voltage:					
Peak value .....	±200 max	±200 max	±200 max	±200 max	volts
Average value .....	100 max	100 max	100 max	100 max	volts
Direct Interelectrode Capacitances:					
Grid No.1 to Cathode, Heater, Grid No.2, Grid No.3, and Internal Shield .....				4.2	pF
Grid No.3 to Cathode, Heater, Grid No.1, Grid No.2, and Internal Shield .....				8.3	pF
Grid No.1 to Grid No.3 .....				0.004 max	pF

**Limiter and Discriminator Service**

MAXIMUM RATINGS (Design-Maximum Values)		
Plate-Supply Voltage .....	330	volts
Grid-No.2 Voltage .....	110	volts
Grid-No.1 Voltage, Positive peak value .....	60	volts
Cathode Current .....	13	mA



**TWIN DIODE—  
HIGH-MU TWIN TRIODE**

**6BN8  
8BN8**

Miniature type used in color and black-and-white television receiver applications. The triode unit is used in burst-amplifier, af amplifier, and low-frequency oscillator applications. The diode units are used in phase-detector, ratio-detector or discriminator, and horizontal afc discriminator circuits. Outlines section, 6E; requires miniature 9-contact socket. Type 8BN8 is identical with type 6BN8 except for heater ratings.

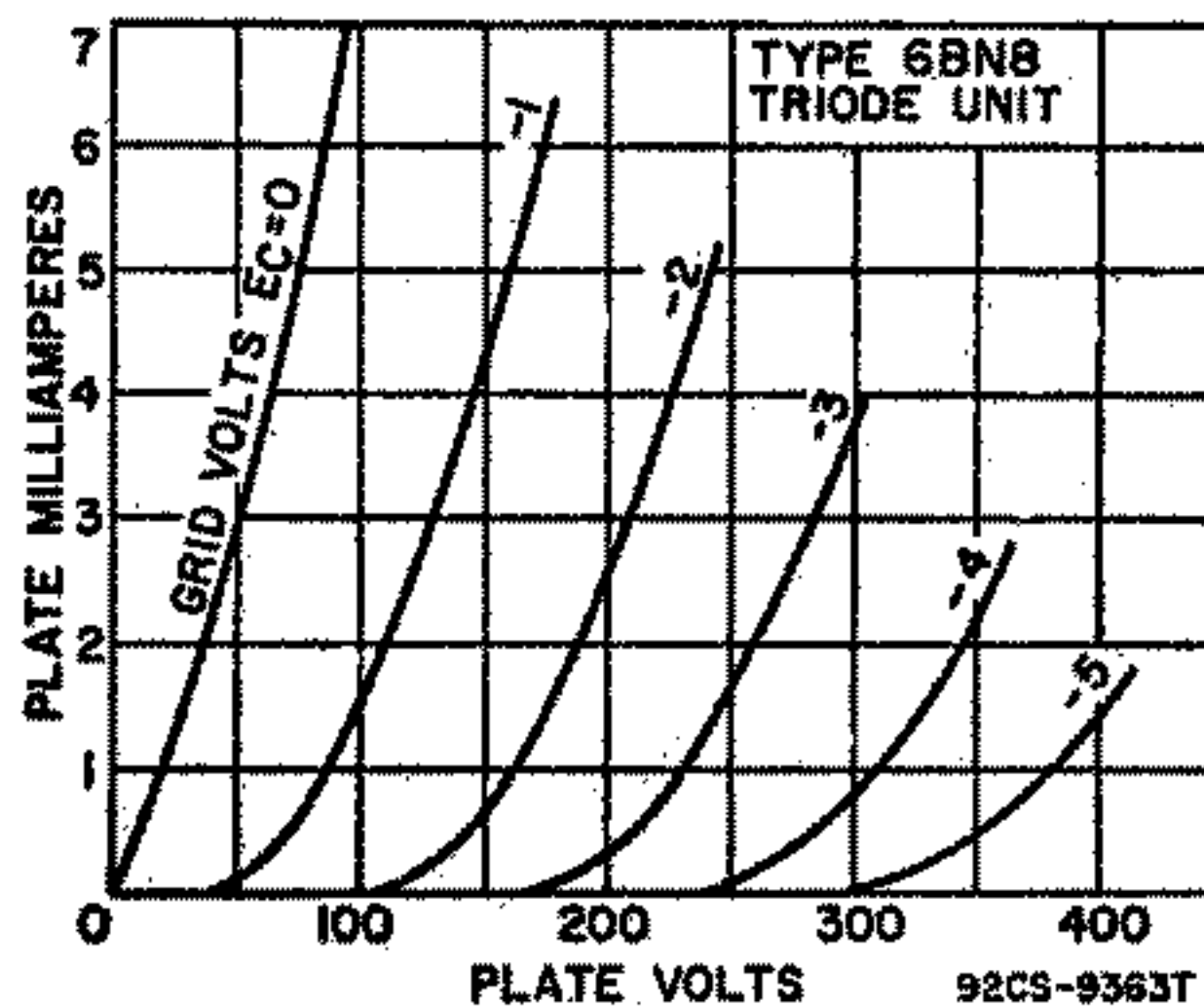
Heater Voltage (ac/dc)	6.3	8.4	volts
Heater Current	0.6	0.45	ampere
Heater Warm-up Time (Average)	11	11	seconds
<b>Heater-Cathode Voltage:</b>			
Peak value	±200 max	±200 max	volts
Average value	100 max	100 max	volts
<b>Direct Interelectrode Capacitances:</b>			
Triode Grid to Triode Plate		2.5	pF
Triode Grid to Cathode and Heater		3.6	pF
Triode Plate to Cathode and Heater		0.25	pF
Plate of Diode Unit No.1 to Triode Grid		0.06 max	pF
Plate of Diode Unit No.2 to Triode Grid		0.1 max	pF
Plate of Diode Unit No.1 to Plate of Diode Unit No.2		0.07 max	pF
Diode Cathode to All Other Electrodes (Each Diode Unit)		5	pF
Diode Plate to Diode Cathode and Heater (Each Diode Unit)		1.9	pF
Diode Cathode to Diode Plate and Heater (Each Diode Unit)		4.8	pF
Diode Plate to All Other Electrodes (Each Diode Unit)		3	pF

**Triode Unit as Class A<sub>1</sub> Amplifier**

<b>MAXIMUM RATINGS (Design-Maximum Values)</b>			
Plate Voltage		330	volts
Grid Voltage, Positive-bias value		0	volts
Plate Dissipation		1.7	watts
<b>CHARACTERISTICS</b>			
Plate Voltage	100	250	volts
Grid Voltage	-1	-3	volts
Amplification Factor	75	70	
Plate Resistance (Approx.)	21000	28000	ohms
Transconductance	3500	2500	μmhos
Plate Current	1.5	1.6	mA
Grid Voltage (Approx.) for plate current of 10 μA	-2.5	-5.5	volts
<b>MAXIMUM CIRCUIT VALUE</b>			
Grid-Circuit Resistance		1.0	megohm

**Diode Units**

<b>MAXIMUM RATINGS (Design-Maximum Values)</b>			
<b>Plate Current (Each Unit):</b>			
Peak		54	mA
Average		9	mA

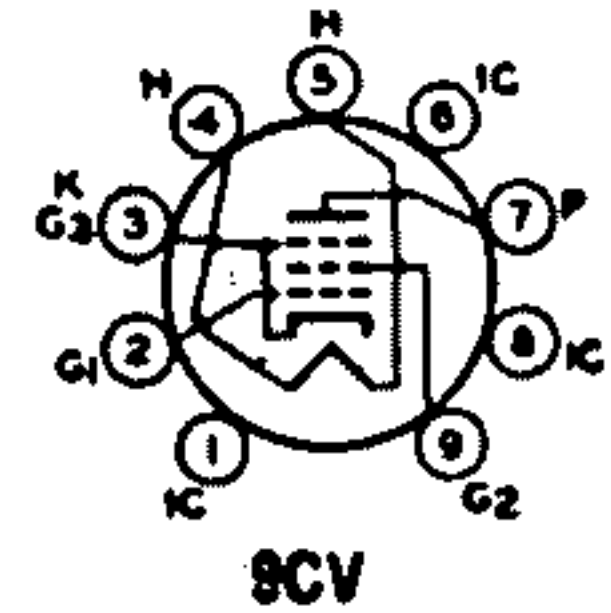


# 6BQ5

8BQ5

## POWER PENTODE

Miniature type used in the output stage of audio-frequency amplifiers. Outlines section, 6G; requires miniature 9-contact socket. Type 8BQ5 is identical with type 6BQ5 except for heater ratings.



	6BQ5	8BQ5	
Heater Voltage (ac/dc)	6.3	8	volts
Heater Current	0.76	0.8	ampere
Heater Warm-up Time (Average)	—	11	seconds
<b>Heater-Cathode Voltage:</b>			
Peak value	±100 max	±100 max	volts
Average value	100 max	100 max	volts
<b>Direct Interelectrode Capacitances:</b>			
Grid No.1 to Plate		0.5 max	pF
Grid No.1 to Cathode, Heater, Grid No.2, and Grid No.3		10.8	pF
Plate to Cathode, Heater, Grid No.2, and Grid No.3		6.5	pF
Grid No.1 to Heater		0.25 max	pF

### Class A<sub>1</sub> Amplifier

#### MAXIMUM RATINGS (Design-Center Values)

Plate Voltage	300	volts
Grid-No.2 (Screen-Grid) Voltage	300	volts
Grid-No.1 (Control-Grid) Voltage, Positive-bias value	0	volts
Cathode Current	65	mA
Plate Dissipation	12	watts
Grid No.2 Input	2	watts

#### TYPICAL OPERATION

Plate Voltage	250	volts
Grid-No.2 Voltage	250	volts
Grid-No.1 (Control-Grid) Voltage	-7.3	volts
Peak AF Grid No.1 Voltage	6.2	volts
Zero-Signal Plate Current	48	mA
Maximum-Signal Plate Current	50.6	mA
Zero-Signal Grid-No.2 Current	5.5	mA
Maximum-Signal Grid-No.2 Current	10	mA
Plate Resistance (Approx.)	38000	ohms
Transconductance	11300	μmhos
Load Resistance	4500	ohms
Total Harmonic Distortion	10	per cent
Maximum-Signal Power Output	5.7	watts

#### MAXIMUM CIRCUIT VALUES

<b>Grid-No.-Circuit Resistance:</b>		
For fixed-bias operation	0.3	megohm
For cathode-bias operation	1.0	megohm

### Push-Pull Class AB<sub>1</sub> Amplifier

#### MAXIMUM RATINGS (Same as for Single-Tube Class A<sub>1</sub> Amplifier)

#### TYPICAL OPERATION (Values are for two tubes)

Plate Supply Voltage	250	300	volts
Grid-No.2 Supply Voltage	250	300	volts
Cathode-Bias Resistor	130	130	ohms
Peak AF Grid-No.1-to-Grid-No.1 Voltage	22.6	28.3	volts
Zero-Signal Plate Current	62	72	mA
Maximum-Signal Plate Current	75	92	mA
Zero-Signal Grid-No.2 Current	7	8	mA
Maximum-Signal Grid-No.2 Current	15	22	mA
Effective Load Resistance (Plate-to-plate)	8000	8000	ohms
Total Harmonic Distortion	3	4	per cent
Maximum-Signal Power Output	11	17	watts

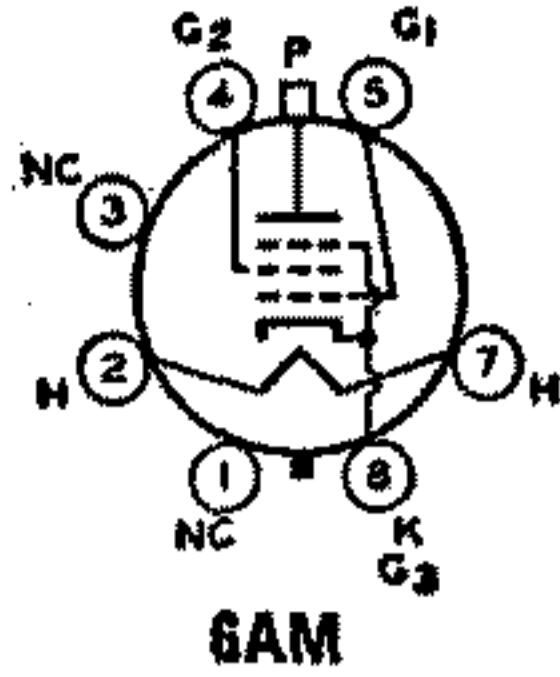
#### MAXIMUM CIRCUIT VALUES

<b>Grid-No.1-Circuit Resistance:</b>		
For fixed-bias operation	0.3	megohm
For cathode-bias operation	1.0	megohm

6BQ6GT

Refer to chart at end of section.





**BEAM POWER TUBE**

**6BQ6GTB  
/6CU6**

12BQ6GTB/12CU6, 17BQ6GTB, 25BQ6GTB/25CU6

Glass octal type used as horizontal-deflection amplifier in color and black-and-white television receivers. Outlines section, 14D; requires octal socket. This type may be supplied with pin No.1 omitted. Types 12BQ6GTB/12CU6, 17BQ6GTB, and 25BQ6GTB/25CU6 are identical with type 6BQ6GTB/6CU6 except for heater ratings.

	6BQ6GTB/ 6CU6	12BQ6GTB/ 12CU6	17BQ6GTB	25BQ6GTB/ 25CU6	
Heater Voltage (ac/dc)	6.3	12.6	16.8	25	volts
Heater Current	1.2	0.6	0.45	0.3	ampere
Heater Warm-up Time (Average)	—	11	11	—	seconds
Heater-Cathode Voltage:					
Peak value	±200 max	±200 max	±200 max	±200 max	volts
Average value	100 max	100 max	100 max	100 max	volts
Direct Interelectrode Capacitances (Approx.):					
Grid No.1 to Plate					0.6 pF
Grid No.1 to Cathode, Heater, Grid No.2, and Grid No.3					15 pF
Plate to Cathode, Heater, Grid No.2, and Grid No.3					7 pF

**Class A<sub>1</sub> Amplifier**

**CHARACTERISTICS**

Plate Voltage	60	150	250	volts
Grid-No.2 Voltage	150	150	150	volts
Grid-No.1 Voltage	0	-22.5	-22.5	volts
Mu-Factor, Grid No.2 to Grid No.1	—	4.3	—	
Plate Resistance (Approx.)	—	—	14500	ohms
Transconductance	—	—	5900	μmhos
Plate Current	260*	—	57	mA
Grid-No.2 Current	26*	—	2.1	mA
Grid-No.1 Voltage (Approx.) for plate mA = 1	—	—	-43	volts

\* These values can be measured by a method involving a recurrent waveform such that the maximum ratings of the tube will not be exceeded.

**Horizontal-Deflection Amplifier**

For operation in a 525-line, 30-frame system

**MAXIMUM RATINGS (Design-Center Values)**

DC Plate Voltage	600	volts
Peak Positive-Pulse Plate Voltage# (Absolute Maximum)	6000†	volts
Peak Negative-Pulse Plate Voltage	-1250	volts
DC Grid-No.2 (Screen-Grid) Voltage	200	volts
Peak Negative-Pulse Grid-No.1 (Control-Grid) Voltage	-300	volts
Peak Cathode Current	400	mA
Average Cathode Current	110	mA
Plate Dissipation*	11	watts
Grid-No.2 Input	2.5	watts
Bulb Temperature (At hottest point)	220	°C

**MAXIMUM CIRCUIT VALUE**

Grid-No.1-Circuit Resistance 0.47 megohm

# Pulse duration must not exceed 15% of a horizontal scanning cycle (10 microseconds).

† Under no circumstances should this absolute value be exceeded.

\* A bias resistor or other means is required to protect the tube in absence of excitation.

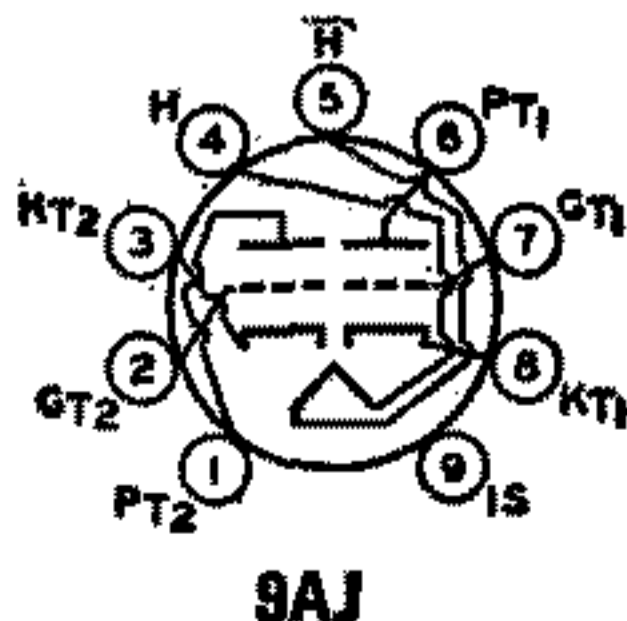
Refer to chart at end of section.

**6BQ7**

**6BQ7A**

4BQ7A, 5BQ7A

**MEDIUM-MU TWIN TRIODE**



Miniature type used as a cascode amplifier in vhf color and black-and-white television tuners in push-pull cathode-drive rf amplifiers. Outlines section, 6B; requires miniature 9-contact socket. For typical operation as a resistance-coupled amplifier, refer to Resistance-Coupled Amplifier section. Types 4BQ7A and 5BQ7A are identical with type 6BQ7A except for heater ratings.

	4BQ7A	5BQ7A	6BQ7A	
Heater Voltage (ac/dc)	4.2	5.6	6.8	volts
Heater Current	0.6	0.45	0.4	ampere
Heater Warm-up Time (Average)	11	11	—	seconds
<b>Heater-Cathode Voltage:</b>				
Peak value	±200*max	±200*max	±200*max	volts
Average value	100 max	100 max	100 max	volts
<b>Direct Interelectrode Capacitances:</b>				
		Unit No.1	Unit No.2	
Grid to Plate		1.2	1.2	pF
Grid to Cathode, Heater, and Internal Shield		2.6	—	pF
Cathode to Grid, Heater, and Internal Shield		—	5.0	pF
Plate to Cathode, Heater, and Internal Shield		1.2	—	pF
Plate to Grid, Heater, and Internal Shield		—	2.2	pF
Plate to Cathode		0.12	0.12	pF
Heater to Cathode		2.6	2.6	pF
Plate of Unit No.1 to Plate of Unit No.2		—	0.010 max	pF
Plate of Unit No.2 to Plate and Grid of Unit No.1		—	0.024 max	pF

\* Rating may be high as 300 volts under cutoff conditions, when tube is used as a cascode amplifier, the two units are connected in series, and heater is negative with respect to cathode.  
 \* With external shield connected to internal shield.

**Class A<sub>1</sub> Amplifier (Each Unit)**

**MAXIMUM RATINGS (Design-Center Values)**

Plate Supply Voltage	250*	volts
Cathode Current	20	mA
Plate Dissipation	2	watts

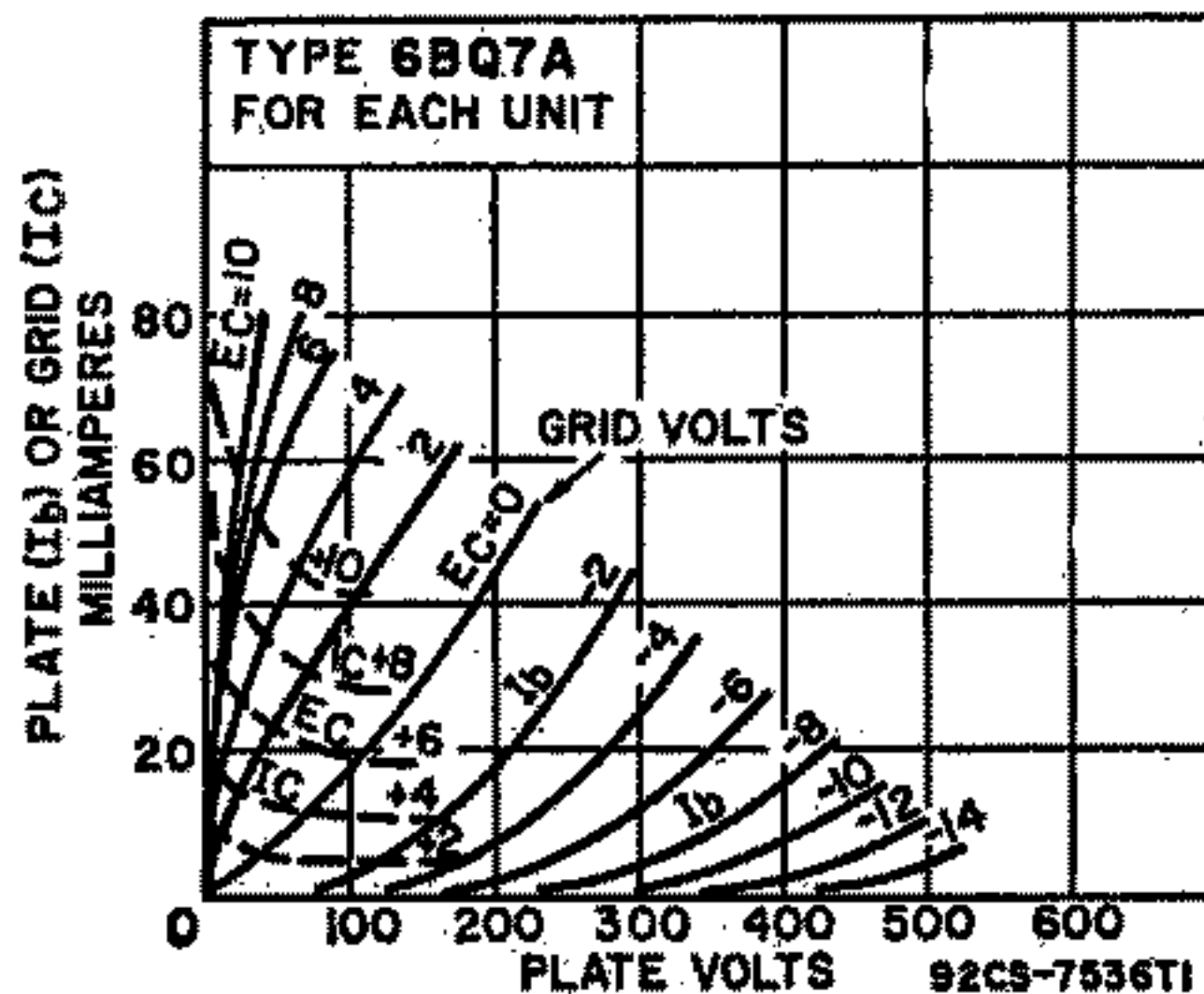
**CHARACTERISTICS**

Plate Supply Voltage	150	volts
Cathode-Bias Resistor	220	ohms
Amplification Factor	38	
Plate Resistance (Approx.)	5900	ohms
Transconductance	6400	μmhos
Plate Current	9	mA
Grid Voltage (Approx.):		
For plate current of 100 μA	-6.5	volts
For plate current of 10 μA	—	volts

**MAXIMUM CIRCUIT VALUE**

Grid-Circuit Resistance	0.5	megohm
-------------------------	-----	--------

\* Rating may be high as 300 volts under cutoff conditions, when tube is used as a cascode amplifier, the two units are connected in series, and heater is negative with respect to cathode.



**6BR8**

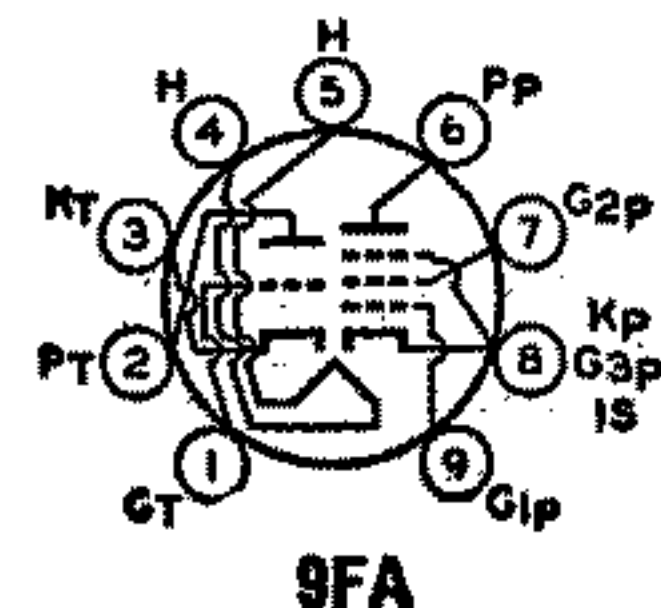
Refer to chart at end of section.

**6BR8A**

**5BR8**

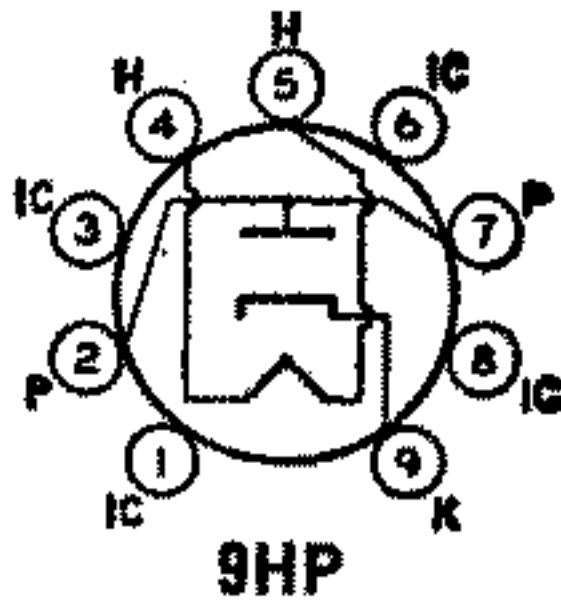
**MEDIUM-MU TRIODE—  
SHARP-CUTOFF PENTODE**

Miniature type used in color and black-and-white television receiver applications. Especially useful as combined triode oscillator and pentode mixer in vhf television tuners. Outlines section, 6B; requires miniature 9-contact socket. Except for basing arrangement and grid-No.1-to-plate capacitance of pentode unit, types 5BR8 and 6BR8A are identical with types 5U8 and 6U8A, respectively.



**9FA**





**HALF-WAVE  
VACUUM RECTIFIER**

**6BS3  
6BS3A**

12BS3, 12BS3A,  
17BS3, 17BS3A

Novar types used as damper tubes in horizontal-deflection circuits of black-and-white television receivers. Outlines section, 11D and 30B, respectively; require novar 9-contact socket. Socket terminals 1, 3, 6, and 8 should not be used as tie points; it is recommended that socket clips for these pins be removed to reduce the possibility of arc-over and to minimize leakage. These tubes, like other power-handling tubes, should be adequately ventilated. Types 12BS3 and 12BS3A and types 17BS3 and 17BS3A are identical with types 6BS3 and 6BS3A, respectively, except for heater ratings.

	6BS3 6BS3A	12BS3 12BS3A	17BS3 17BS3A	
Heater Voltage (ac/dc) .....	6.3	12.6	16.8	volts
Heater Current .....	1.2	0.6	0.45	amperes
Heater Warm-up Time (Average) .....	—	11	11	seconds
Direct Interelectrode Capacitances (Approx.):				
Plate to Cathode and Heater .....			6.5	pF
Cathode to Plate and Heater .....			9	pF
Heater to Cathode .....			2.8	pF

**Damper Service**

For operation in a 525-line, 30-frame system

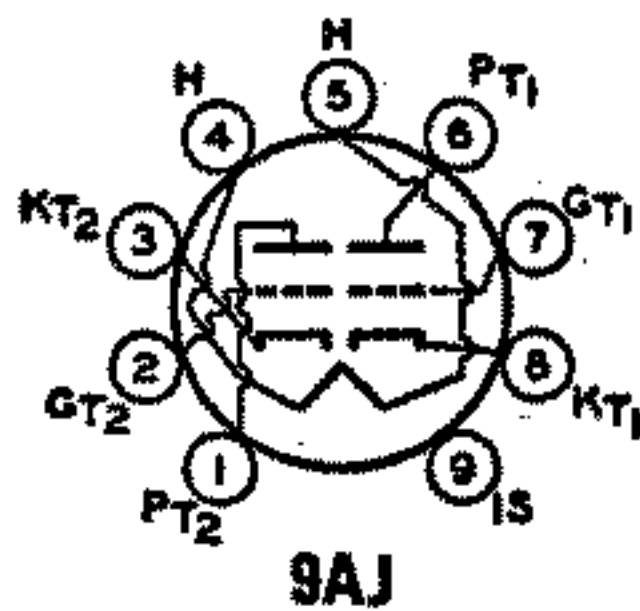
**MAXIMUM RATINGS (Design-Maximum Values)**

Peak Inverse Plate Voltage# .....		5000	volts
Peak Plate Current .....		1100	mA
Average Plate Current .....		200	mA
Plate Dissipation .....		6	watts
Heater-Cathode Voltage:			
Peak value .....	+300	—5000	volts
Average value .....	+100	—900	volts

**CHARACTERISTICS, Instantaneous Value**

Tube Voltage Drop for plate current of 140 mA ..... 12 volts

# Pulse duration must not exceed 15% of a horizontal scanning cycle (10 microseconds).



**MEDIUM-MU TWIN TRIODE**

**6BS8**

4BS8

Miniature type used as a cascode amplifier in vhf color and black-and-white television tuners and in push-pull cathode-drive rf amplifiers. Outlines section, 6B; requires miniature 9-contact socket. Type 4BS8 is identical with type 6BS8 except for heater ratings.

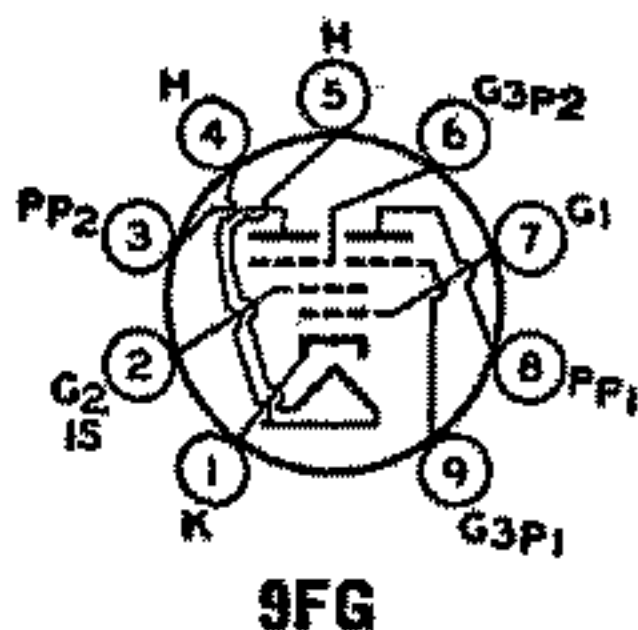
	4BS8	6BS8	
Heater Voltage (ac/dc) .....	4.5	6.3	volts
Heater Current .....	0.6	0.4	ampere
Heater Warm-up Time (Average) .....	11	—	seconds
Peak Heater-Cathode Voltage .....	±200 max	±200 max	volts
Direct Interelectrode Capacitances:			
Grid to Plate (Each Unit) .....		1.15	pF
Grid to Cathode, Heater, and Internal Shield (Unit No.1) .....		2.6	pF
Plate to Cathode, Heater, and Internal Shield (Unit No.1) .....		1.2	pF
Plate to Cathode (Each Unit) .....		0.15 max	pF
Heater to Cathode (Each Unit) .....		2.6	pF
Cathode to Grid, Heater, and Internal Shield (Unit No.2) .....		5	pF
Plate to Grid, Heater, and Internal Shield (Unit No.2) .....		2.2	pF
Plate of Unit No.1 to Plate of Unit No.2 .....		0.010 max	pF
Plate of Unit No.2 to Plate and Grid of Unit No.1 .....		0.024 max	pF



**Class A<sub>1</sub> Amplifier (Each Unit)**

<b>MAXIMUM RATINGS (Design-Center Values)</b>		
Plate Voltage .....	150	volts
Cathode Current .....	20	mA
Plate Dissipation .....	2	watts
<b>CHARACTERISTICS</b>		
Plate-Supply Voltage .....	150	volts
Cathode-Bias Resistor .....	220	ohms
Amplification Factor .....	36	
Plate Resistance (Approx.) .....	5000	ohms
Transconductance .....	7200	μmhos
Plate Current .....	10	mA
Grid Voltage (Approx.) for plate current of 10 μA* .....	-7	volts
<b>MAXIMUM CIRCUIT VALUE</b>		
Grid-Circuit Resistance .....	0.5	megohm

\* This value applies to Unit No.2 only.



**9FG**

**SHARP-CUTOFF  
TWIN PENTODE**

Miniature type used as combined sync separator, sync clipper, and age amplifier tube in color and black-and-white television receivers. Outlines section, 6E; requires miniature 9-contact socket. Types 3BU8, 3BU8/3GS8, 4BU8 and 4BU8/4GS8 are identical with type 6BU8 except for heater ratings.

**6BU8**

3BU8, 3BU8/3GS8  
4BU8, 4BU8/4GS8

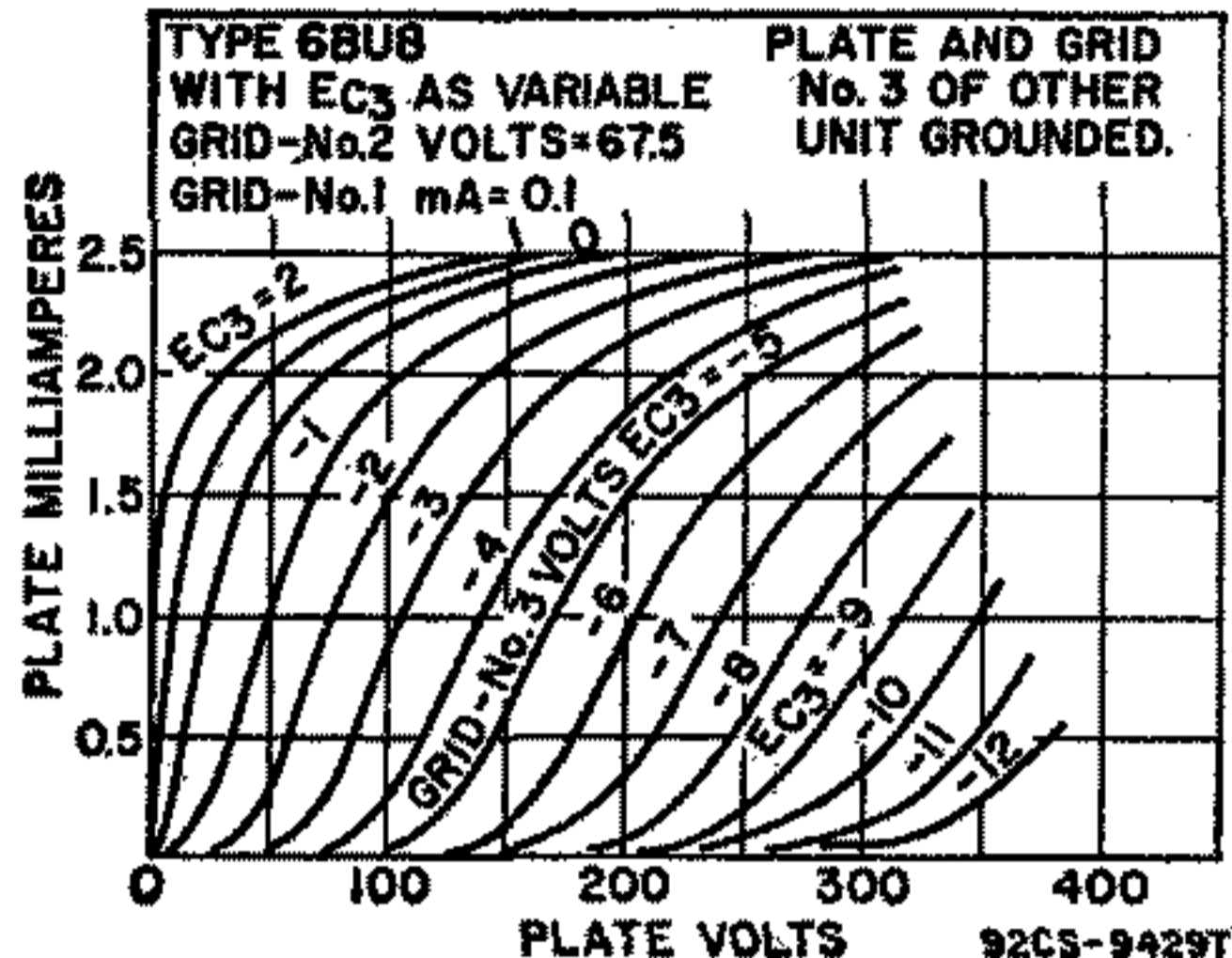
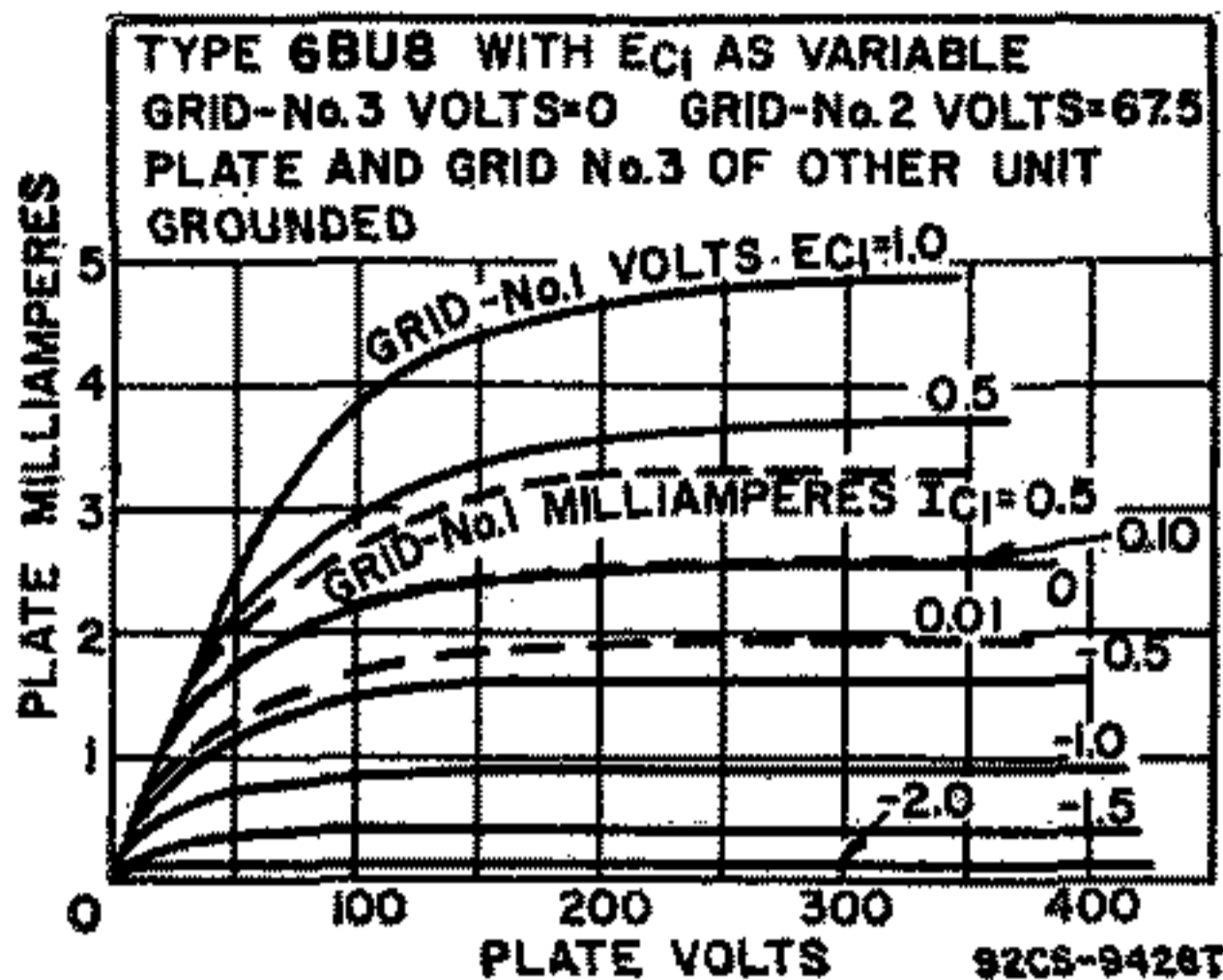
	3BU8 3BU8/3GS8	4BU8 4BU8/4GS8	6BU8	
Heater Voltage (ac/dc) .....	3.15	4.2	6.3	volts
Heater Current .....	0.6	0.45	0.3	ampere
Heater Warm-up Time (Average) .....	11	11	—	seconds
<b>Heater-Cathode Voltage:</b>				
Peak value .....	±200 max	±200 max	±200 max	volts
Average value .....	100 max	100 max	100 max	volts
<b>Direct Interelectrode Capacitances:</b>				
Grid No.3 to Plate (Each Unit) .....			1.9	pF
Grid No.1 to All Other Electrodes .....			6	pF
Grid No.3 to All Other Electrodes (Each Unit) .....			3.6	pF
Plate to All Other Electrodes (Each Unit) .....			3	pF
Grid No.3 of Unit No.1 to Grid No.3 of Unit No.2 .....			0.015 max	pF

**Class A<sub>1</sub> Amplifier**

<b>MAXIMUM RATINGS (Design-Maximum Values)</b>		
Plate Voltage (Each Unit) .....	300	volts
<b>Grid-No.3 (Suppressor-Grid) Voltage (Each Unit):</b>		
Peak positive value .....	50	volts
DC negative value .....	-50	volts
DC positive value .....	3	volts
Grid-No.2 (Screen-Grid) Voltage .....	150	volts
Grid-No.1 (Control-Grid) Voltage, Negative bias value .....	-50	volts
Cathode Current .....	12	mA
Plate Dissipation (Each Unit) .....	1.1	watts
Grid-No.2 Input .....	0.75	watt
<b>CHARACTERISTICS (With Both Units Operating)</b>		
Plate Voltage (Each Unit) .....	100	volts
Grid-No.3 Voltage (Each Unit) .....	-10	volts
Grid-No.2 Voltage .....	67.5	volts
Grid-No.1 Voltage .....	*	volts
Plate Current (Each Unit) .....	—	2.2
Grid-No.2 Current .....	6.5	mA
Cathode Current .....	6.6	mA
<b>CHARACTERISTICS (With One Unit Operating)</b>		
Plate Voltage .....	100	volts
Grid-No.3 Voltage .....	0	volts
Grid-No.2 Voltage .....	67.5	volts
Grid-No.1 Voltage .....	0	volts
Grid-No.3 Transconductance .....	—	180
Grid-No.1 Transconductance .....	1500	μmhos
Plate Current .....	—	2.2
Grid-No.3 Voltage (Approx.) for plate current of 100 μA .....	—	-4.5
Grid-No.1 Voltage (Approx.) for plate current of 100 μA .....	—	-2.3

**MAXIMUM CIRCUIT VALUES**

Grid-No.3-Circuit Resistance (Each Unit) .....	0.5	megohm
Grid-No.1-Circuit Resistance .....	0.5	megohm
* Adjusted to provide a dc grid-No.1 current of 100 microamperes.		
† With plate and grid No.3 of the other unit connected to ground.		

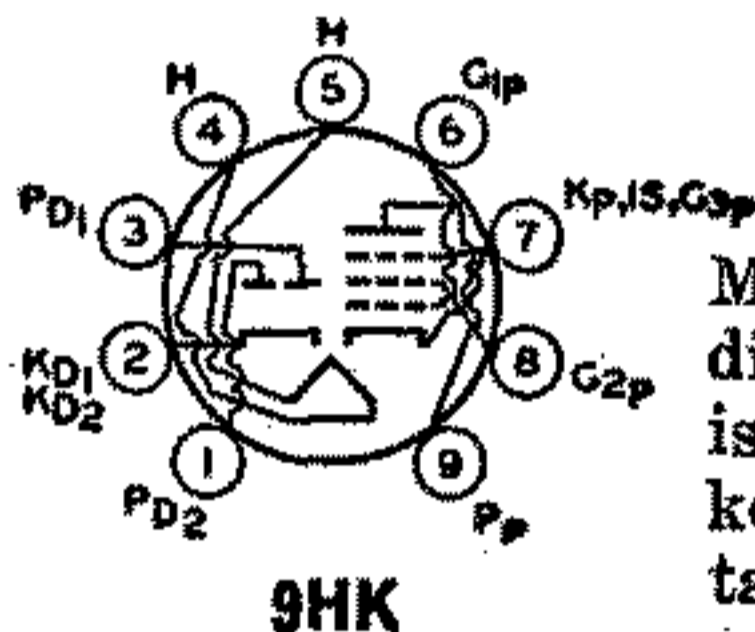


**6BV8**

Refer to chart at end of section.

**6BW4**

Refer to chart at end of section.



**9HK**

**TWIN DIODE—  
SHARP-CUTOFF PENTODE**

**6BW8**

**5BW8**

Miniature type used in television receiver applications; diodes are used as horizontal phase detectors; pentode is used as a sound if amplifier, sound limiter, and age keyer. Outlines section, 6B; requires miniature 9-contact socket. Type 5BW8 is identical with type 6BW8 except for heater ratings.

Heater Voltage (ac/dc) .....	5BW8	6BW8	
Heater Current .....	4.7	6.3	volts
Heater Warm-up Time (Average) .....	0.6	0.45	ampere
Heater-Cathode Voltage:	11	—	seconds
Peak value .....	±200 max	±200 max	volts
Average value .....	100 max	100 max	volts
Direct Interelectrode Capacitances:			
Pentode Unit:			
Grid No.1 to Plate .....		0.02 max	pF
Grid No.1 to Cathode, Heater, Grid No.2, Grid No.3, and Internal Shield .....		4.8	pF
Plate to Cathode, Heater, Grid No.2, Grid No.3, and Internal Shield .....		2.6	pF
Plate of Diode Unit No.1 to Cathode and Heater .....		1.3	pF
Plate of Diode Unit No.2 to Cathode and Heater .....		1.2	pF
Pentode Grid No.1 to Either Diode Plate .....		0.006 max	pF

**Pentode Unit as Class A<sub>1</sub> Amplifier**

**MAXIMUM RATINGS (Design-Maximum Values)**

Plate Voltage .....	330	volts
Grid-No.2 (Screen-Grid) Supply Voltage .....	330	volts
Grid-No.2 Voltage .....	See curve page 96	
Grid-No.1 (Control-Grid) Voltage:		
Positive-bias value .....	0	volts
Negative-bias value .....	-55	volts
Plate Dissipation .....	3	watts
Grid-No.2 Input:		
For grid-No.2 voltages up to 165 volts .....	0.55	watt
For grid-No.2 voltages between 165 and 330 volts .....	See curve page 96	

**CHARACTERISTICS**

Plate Voltage .....	250	volts
Grid-No.2 Voltage .....	110	volts
Cathode-Bias Resistor .....	68	ohms
Plate Resistance (Approx.) .....	0.25	megohm
Transconductance .....	5200	μmhos
Plate Current .....	10	mA
Grid-No.2 Current .....	3.5	mA
Grid-No.1 Voltage (Approx.) for plate current of 10 μA .....	-10	volts

**MAXIMUM CIRCUIT VALUES**

Grid-No.1 Circuit Resistance:		
For fixed-bias operation .....	0.1	megohm
For cathode-bias operation .....	0.6	megohm

**Diode Units (Each Unit)**

**MAXIMUM RATING (Design-Maximum Value)**

Plate Current .....	5	mA
---------------------	---	----

**6BX7GT**

Refer to chart at end of section.

**6BY5GA**

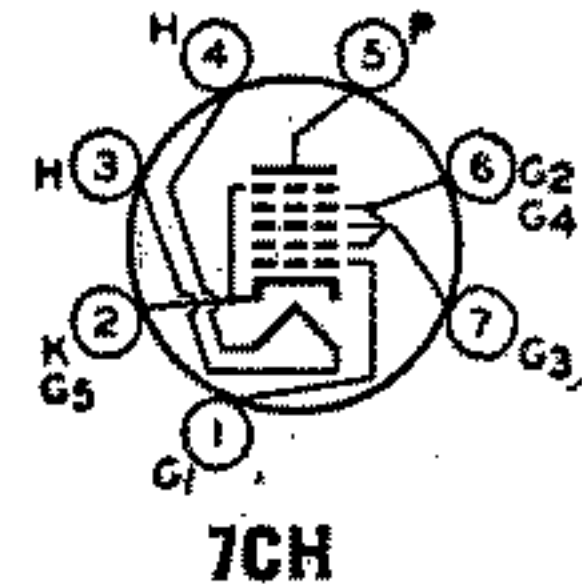
Refer to chart at end of section.

**6BY6**

3BY6

**PENTAGRID AMPLIFIER**

Miniature type used as a gated amplifier in color television receivers. In such service, it may be used as a combined sync separator and sync clipper. Outlines section, 5C; requires miniature 7-contact socket. Type 3BY6 is identical with type 6BY6 except for heater ratings.



Heater Voltage (ac/dc) .....	3BY6	6BY6	
Heater Current .....	3.15	6.3	volts
Heater Warm-up Time (Average) .....	0.6	0.3	ampere
Peak value .....	11	—	seconds
Average value .....	±200 max	±200 max	volts
Direct Interelectrode Capacitances:	100 max	100 max	volts
Grid No.1 to Plate .....		0.08 max	pF
Grid No.3 to Plate .....		0.35 max	pF
Grid No.1 to Grid No.3 .....		0.22 max	pF
Grid No. 1 to All Other Electrodes .....		5.4	pF
Grid No.3 to All Other Electrodes .....		6.9	pF
Plate to All Other Electrodes .....		7.6	pF

**Class A<sub>1</sub> Amplifier**

**CHARACTERISTICS**

Plate Voltage .....	250	volts
Grids-No.2-and-No.4 Voltage .....	100	volts
Grid-No.3 Voltage .....	-2.5	volts
Grid-No.1 Voltage .....	-2.5	volts
Grid-No.3-to-Plate Transconductance .....	500	μmhos
Grid-No.1-to-Plate Transconductance .....	1900	μmhos
Plate Current .....	6.5	mA
Grids-No.2-and-No.4 Current .....	9	mA
Grid-No.3 Volts (Approx.) for plate current of 35 μA and grid-No.1 volts = -4 .....	-15	volts
Grid-No.1 Volts (Approx.) for plate current of 35 μA and grid-No.3 volts = 0 .....	-12	volts

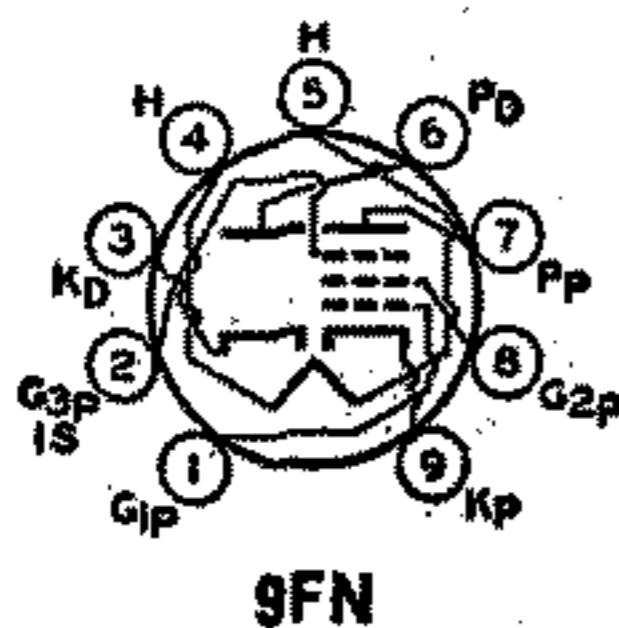
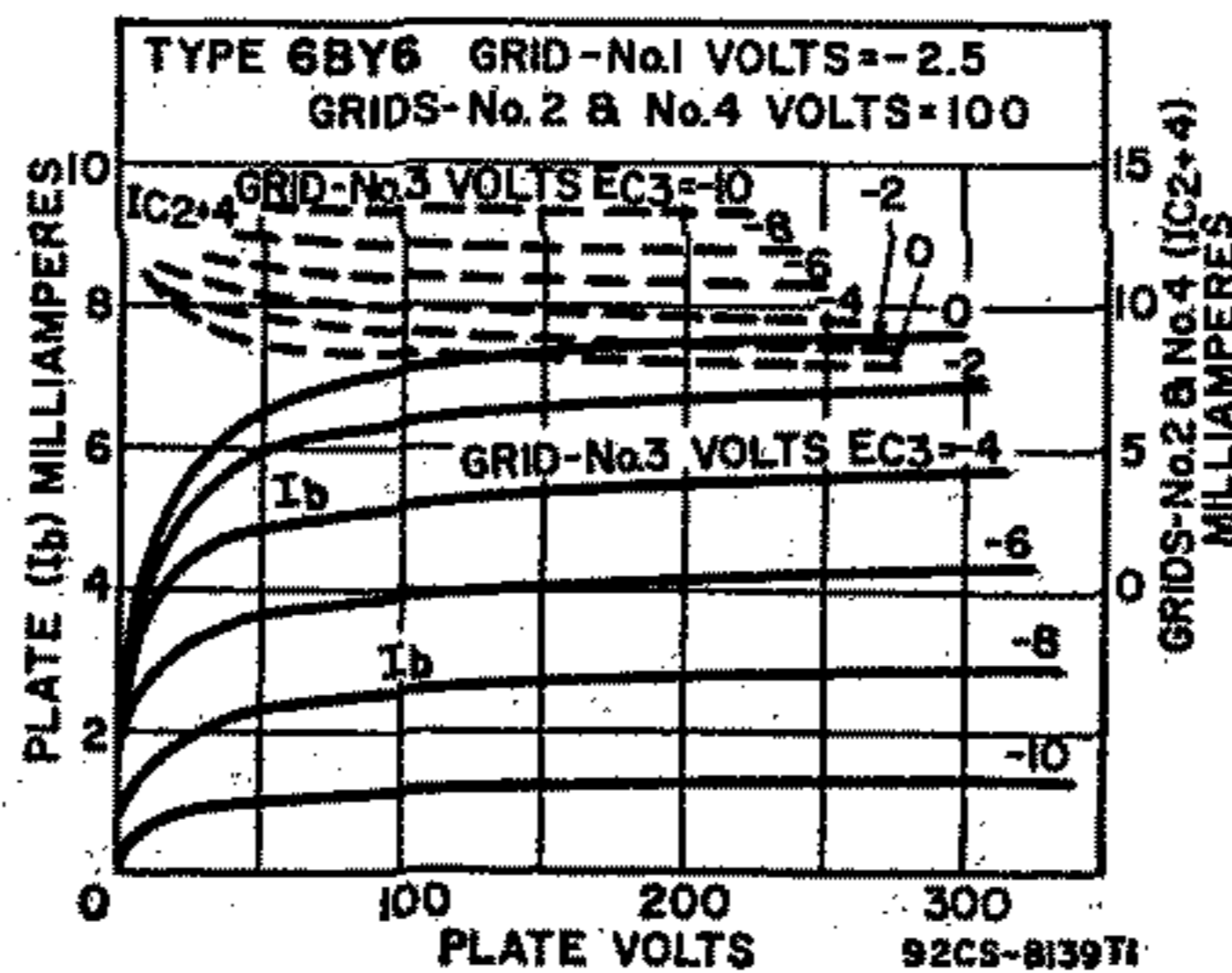
**Gated Amplifier**

**MAXIMUM RATINGS (Design-Maximum Values)**

Plate Voltage .....	330	volts
Grids-No.2-and-No.4 Voltage .....	See curve page 96	
Grids-No.2-and-No.4 Supply Voltage .....	330	volts
Grid-No.3 Voltage:		
Negative-bias value .....	-55	volts
Positive-bias value .....	0	volts
Positive peak value .....	27	volts
Grid-No.1 Voltage, Negative bias value .....	-110	volts
Plate Dissipation .....	2.3	watts
Grid-No.3 Input .....	0.1	watt



Grids-No.2-and-No.4 Input:		
For grids-No.2-and-No.4 voltages up to 165 volts .....	1.1	watts
For grids-No.2-and-No.4 voltages between 165 and 330 volts .....	See curve page 96	watt
Grid-No.1 Input .....	0.1	watt
<b>CHARACTERISTICS AS SYNC SEPARATOR AND SYNC CLIPPER</b>		
Plate Voltage .....	10	volts
Grid-No.3 Voltage .....	0	volts
Grids-No.2-and-No.4 Voltage .....	25	volts
Grid-No.1 Voltage .....	0	volts
Plate Current .....	1.4	mA
Grids-No.2-and-No.4 Current .....	3.5	mA
Grid-No.3 Volts (Approx.) for plate voltage of 25 volts, grids-No.2-and-No.4 voltage of 25 volts, grid-No.1 voltage of 0 volts, and plate current of 50 $\mu$ A .....	-2.5	volts
Grid-No.1 Volts (Approx.) for plate voltage of 25 volts, grids-No.2-and-No.4 voltage of 25 volts, grid-No.3 voltage of 0 volts, and plate current of 50 $\mu$ A .....	-2.3	volts
<b>MAXIMUM CIRCUIT VALUES</b>		
Grid-No.1 or Grid-No.3-Circuit Resistance:		
For fixed-bias operation .....	0.5	megohm
For cathode-bias operation .....	1.0	megohm



**DIODE—  
SHARP-CUTOFF PENTODE**

**6BY8**

Miniature type used in television receiver applications. The pentode unit is used as an rf amplifier and the high-perveance diode as a limiter or detector. Outlines section, 6E; requires miniature 9-contact socket.

Heater Voltage (ac/dc) .....	6.3	volts
Heater Current .....	0.6	ampere
Heater Warm-up Time (Average) .....	11	seconds
Heater-Cathode Voltage:		
Peak value .....	$\pm 200$ max	volts
Average value .....	100 max	volts
Direct Interelectrode Capacitances:*		
Pentode Unit:		
Grid No.1 to Plate .....	0.0035 max	pF
Grid No.1 to Cathode, Heater, Grid No.2, Grid No.3, and Internal Shield .....	5.5	pF
Plate to Cathode, Heater, Grid No.2, Grid No.3, and Internal Shield .....	5	pF
Diode Plate to All Other Electrodes .....	4.8*	pF

\* With external shield connected to cathode of pentode unit (pin 9), except as noted.  
\* With external shield connected to ground.

**Pentode Unit as Class A<sub>1</sub> Amplifier**

<b>MAXIMUM RATINGS (Design-Center Values)</b>		
Plate Voltage .....	300	volts
Grid-No.3 (Suppressor-Grid) Voltage, Positive value .....	0	volts
Grid-No.2 (Screen Grid) Supply Voltage .....	300	volts
Grid-No.2 Voltage .....	See curve page 96	
Grid-No.1 (Control-Grid) Voltage:		
Negative-bias value .....	-50	volts
Positive-bias value .....	0	volts

Plate Dissipation .....	3	watts
Grid-No.2 Input:		
For grid-No.2 voltages up to 150 volts .....	0.65	watt
For grid-No.2 voltages between 150 and 300 volts .....	See curve page 96	

**CHARACTERISTICS**

Plate Supply Voltage .....	100	250	volts
Grid No.3 .....	Connected to cathode at socket		
Grid-No.2 Supply Voltage .....	100	150	volts
Cathode-Bias Resistor .....	150	68	ohms
Plate Resistance (Approx.) .....	0.5	1	megohm
Transconductance .....	3900	5200	$\mu$ mhos
Plate Current .....	5	10.6	mA
Grid-No.2 Current .....	2.1	4.3	mA
Grid-No.1 Voltage (Approx.) for plate current of 10 $\mu$ A .....	-4.2	-6.5	volts

**MAXIMUM CIRCUIT VALUES**

Grid-No.1-Circuit Resistance:		
For fixed-bias operation .....	0.25	megohm
For cathode-bias operation .....	1.0	megohm

**Diode Unit**

**MAXIMUM RATINGS (Design-Center Values)**

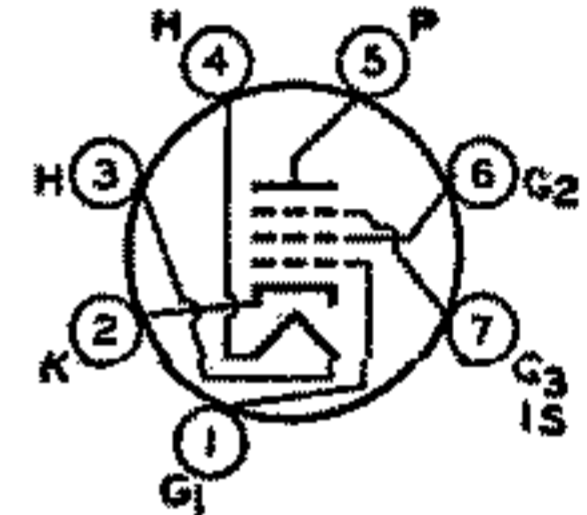
Peak Inverse Plate Voltage .....	430	volts
Peak Plate Current .....	180	mA
Average Plate Current .....	45	mA

**6BZ6**

**SEMIREMOTE-CUTOFF PENTODE**

3BZ6, 4BZ6, 12BZ6

Miniature type used in gain-controlled video if stages of color and black-and-white television receivers. Outlines section, 5C; requires miniature 7-contact socket. Types 3BZ6, 4BZ6, and 12BZ6 are identical with type 6BZ6 except for heater ratings.



7CM

	3BZ6	4BZ6	6BZ6	12BZ6	
Heater Voltage (ac/dc) .....	3.15	4.2	6.3	12.6	volts
Heater Current .....	0.6	0.45	0.3	0.15	ampere
Heater Warm-up Time (Average) .....	11	11	—	—	seconds
Heater-Cathode Voltage:					
Peak value .....	$\pm 200$ max	$\pm 200$ max	$\pm 200$ max	$\pm 200$ max	volts
Average value .....	100 max	100 max	100 max	100 max	volts
Direct Interelectrode Capacitances:			Unshielded	Shielded	
Grid No.1 to Plate .....			0.025 max	0.015 max	pF
Grid No.1 to Cathode, Heater, Grid No.2, Grid No.3, and Internal Shield .....			7	7	pF
Plate to Cathode, Heater, Grid No.2, Grid No.3, and Internal Shield .....			2	3	pF

<sup>a</sup> With external shield connected to cathode.

**Class A<sub>1</sub> Amplifier**

**MAXIMUM RATINGS (Design-Maximum Values)**

Plate Voltage .....	330	volts
Grid No.3 (Suppressor-Grid) Voltage, Positive value .....	0	volts
Grid-No.2 (Screen-Grid) Supply Voltage .....	330	volts
Grid-No.2 Voltage .....	See curve page 96	
Grid-No.1 (Control-Grid) Voltage, Positive-bias value .....	0	volts
Plate Dissipation .....	2.3	watts
Grid-No.2 Input:		
For grid-No.2 voltages up to 165 volts .....	0.55	watt
For grid-No.2 voltages between 165 and 330 volts .....	See curve page 96	

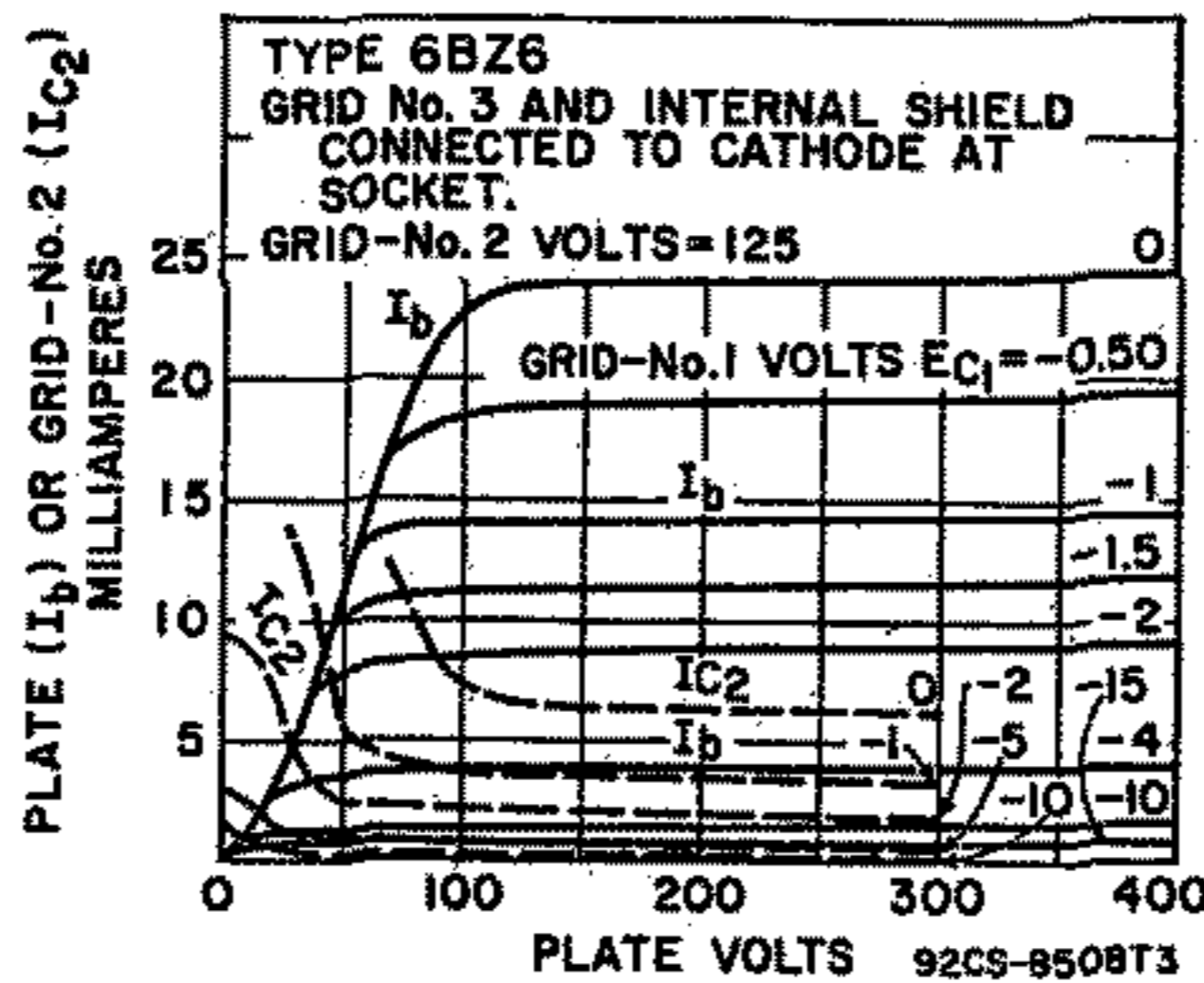
**CHARACTERISTICS**

Plate Supply Voltage .....	125	volts
Grid No.3 .....	Connected to cathode at socket	
Grid-No.2 Supply Voltage .....	125	volts
Cathode-Bias Resistor .....	56	ohms
Plate Resistance (Approx.) .....	0.26	megohm
Transconductance .....	8000	$\mu$ mhos
Plate Current .....	14	mA
Grid-No.2 Current .....	3.6	mA
Grid-No.1 Voltage (Approx.) for transconductance of 50 $\mu$ mhos ..	-19	volts
Grid-No.1 Voltage (Approx.) for transconductance of 700 $\mu$ mhos ..	-4.5	volts

**MAXIMUM CIRCUIT VALUES**

Grid-No.1-Circuit Resistance:

For fixed-bias operation .....	0.25	megohm
For cathode-bias operation .....	1.0	megohm

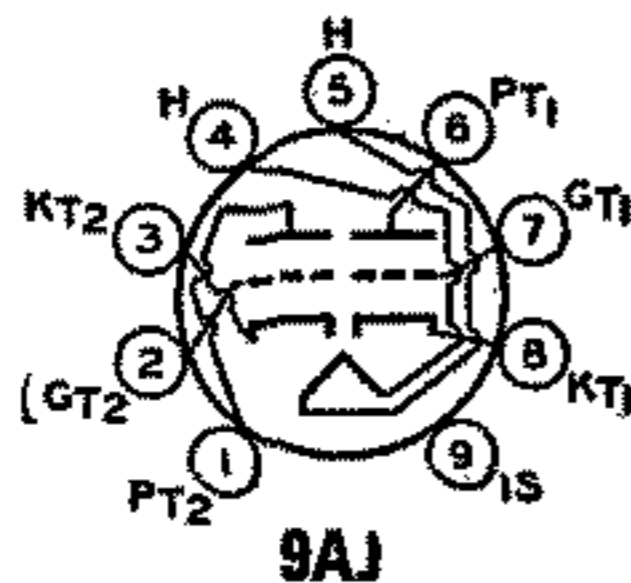


**6BZ7**

4BZ7

**MEDIUM-MU TWIN TRIODE**

Miniature type used as a cascode amplifier in vhf color and black-and-white television tuners and in push-pull cathode-drive rf amplifiers. Outlines section, 6B; requires miniature 9-contact socket. For typical operation as a resistance-coupled amplifier, refer to Resistance-Coupled Amplifier section. Type 4BZ7 is identical with type 6BZ7 except for heater ratings.



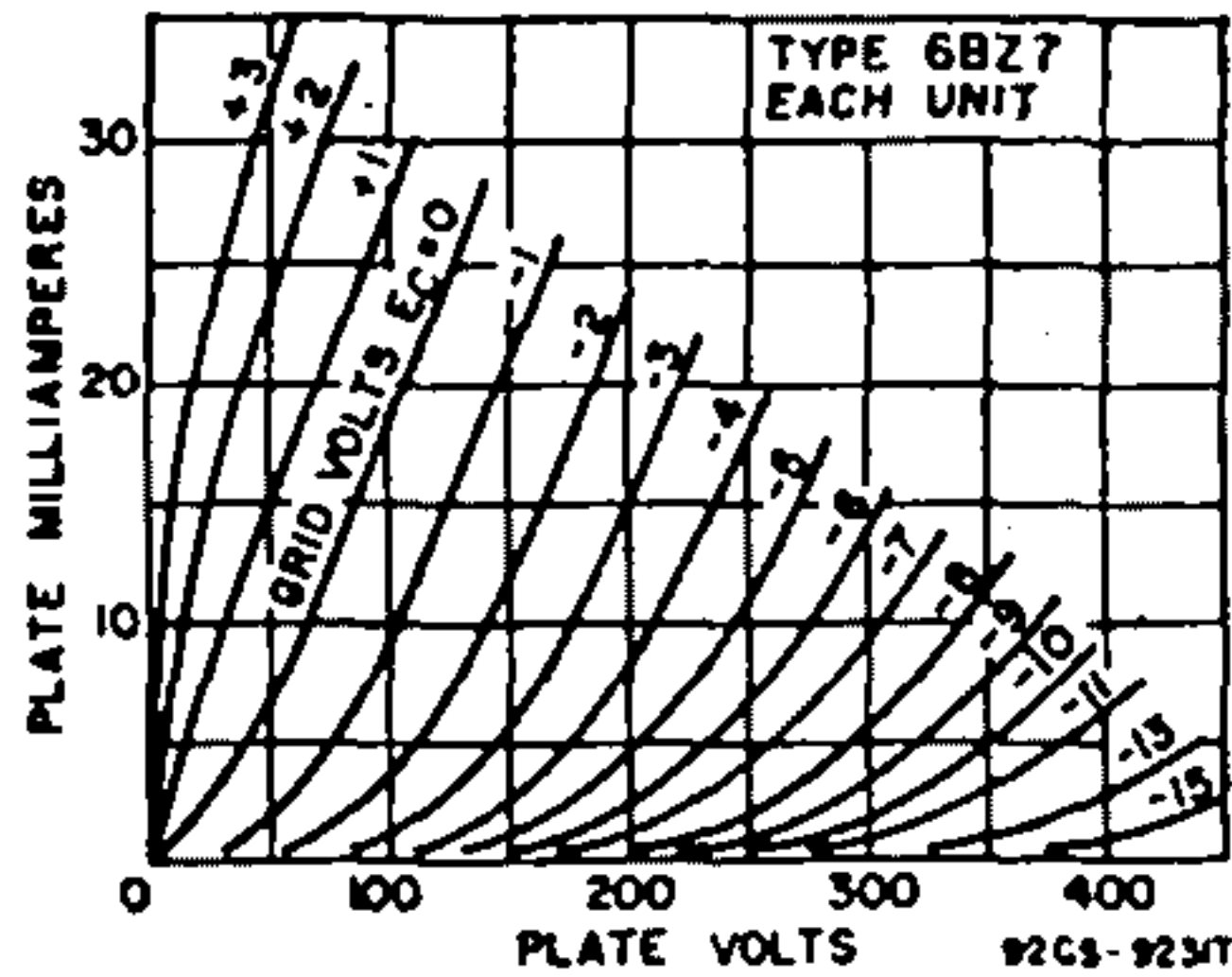
	<b>4BZ7</b>	<b>6BZ7</b>	
Heater Voltage (ac/dc) .....	4.2	6.3	volts
Heater Current .....	0.6	0.4	ampere
Heater Warm-up Time (Average) .....	11	—	seconds
Heater-Cathode Voltage:			
Peak value .....	$\pm 200^*$ max	$\pm 200^*$ max	volts
Average value .....	100 max	100 max	volts
Direct Interelectrode Capacitances:			
Grid to Plate (Each Unit) .....		1.2	pF
Grid to Cathode, Heater, and Internal Shield (Unit No.1) .....		2.6	pF
Plate to Cathode, Heater, and Internal Shield (Unit No.1) .....		1.2	pF
Plate to Cathode (Each Unit) .....		0.12	pF
Heater to Cathode (Each Unit) .....		2.6	pF
Cathode to Grid, Heater, and Internal Shield (Unit No.2) .....		5	pF
Plate to Grid, Heater, and Internal Shield (Unit No.2) .....		2.2	pF
Plate of Unit No.1 to Plate of Unit No.2 .....		0.010 max	pF
Plate of Unit No.2 to Plate and Grid of Unit No.1 .....		0.024 max	pF

\* Rating may be as high as 300 volts under cutoff conditions, when tube is used as a cascode amplifier, the two units are connected in series, and heater is negative with respect to cathode.

**Class A<sub>1</sub> Amplifier**

<b>MAXIMUM RATINGS (Design-Center Values)</b>		
Plate Voltage .....	250*	volts
Cathode Current .....	20	mA
Plate Dissipation .....	2.0	watts
<b>CHARACTERISTICS</b>		
Plate Supply Voltage .....	150	volts
Cathode-Bias Resistor .....	220	ohms
Amplification Factor .....	36	
Plate Resistance (Approx.) .....	5300	ohms
Transconductance .....	6800	$\mu$ mhos
Plate Current .....	10	mA
Grid Voltage (Approx.) for plate current of 100 $\mu$ A .....	-7	volts
<b>MAXIMUM CIRCUIT VALUE</b>		
Grid-Circuit Resistance .....	0.5	megohm





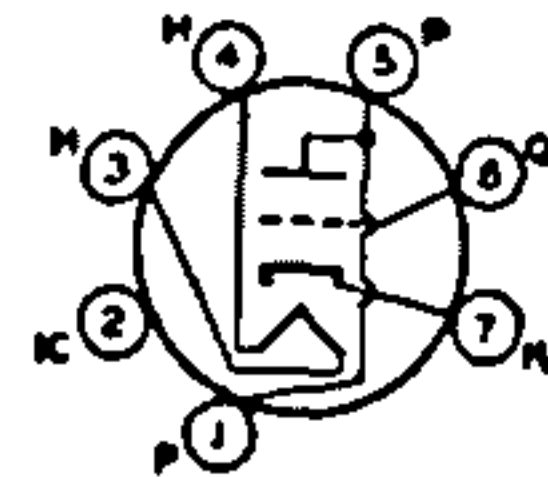
**6BZ8**

Refer to chart at end of section.

**6C4**

**POWER TRIODE**

Miniature type used as a cascode amplifier in vhf color local oscillator in FM and other high-frequency circuits and as a class C rf amplifier. Outlines section, 5C; requires miniature 7-contact socket. For typical operation as a resistance-coupled amplifier, refer to Resistance-Coupled Amplifier section. For additional curve of plate characteristics, refer to type 12AU7A.



**6BG**

Heater Voltage (ac/dc) .....	6.3	volts	
Heater Current .....	0.15	ampere	
Heater-Cathode Voltage:			
Peak value .....	±200 max	volts	
Average value .....	100 max	volts	
Direct Interelectrode Capacitances (Approx.)	Unshielded	Shielded*	
Grid to Plate .....	1.8	1.4	pF
Grid to Cathode and Heater .....	1.8	1.8	pF
Plate to Cathode and Heater .....	1.5	2.5	pF

\* With external shield connected to cathode.

**Class A<sub>1</sub> Amplifier**

<b>MAXIMUM RATINGS (Design-Center Values)</b>		
Plate Voltage .....	800 max	volts
Plate Dissipation .....	3.5 max	watts

<b>CHARACTERISTICS</b>			
Plate Voltage .....	100	250	volts
Grid Voltage* .....	0	-8.5	volts
Amplification Factor .....	19.5	17	
Plate Resistance (Approx.) .....	6250	7700	ohms
Transconductance .....	8100	2200	μmhos
Plate Current .....	11.8	10.6	mA
Grid Voltage (Approx.) for plate current of 10 μA ..	-10	-25	volts

<b>MAXIMUM CIRCUIT VALUES</b>		
Grid-Circuit Resistance:		
For fixed bias operation .....	0.25	megohm
For cathode-bias operation .....	1.0	megohm

\* Transformer- or impedance-type input coupling devices are recommended to minimize resistance in the grid circuit.

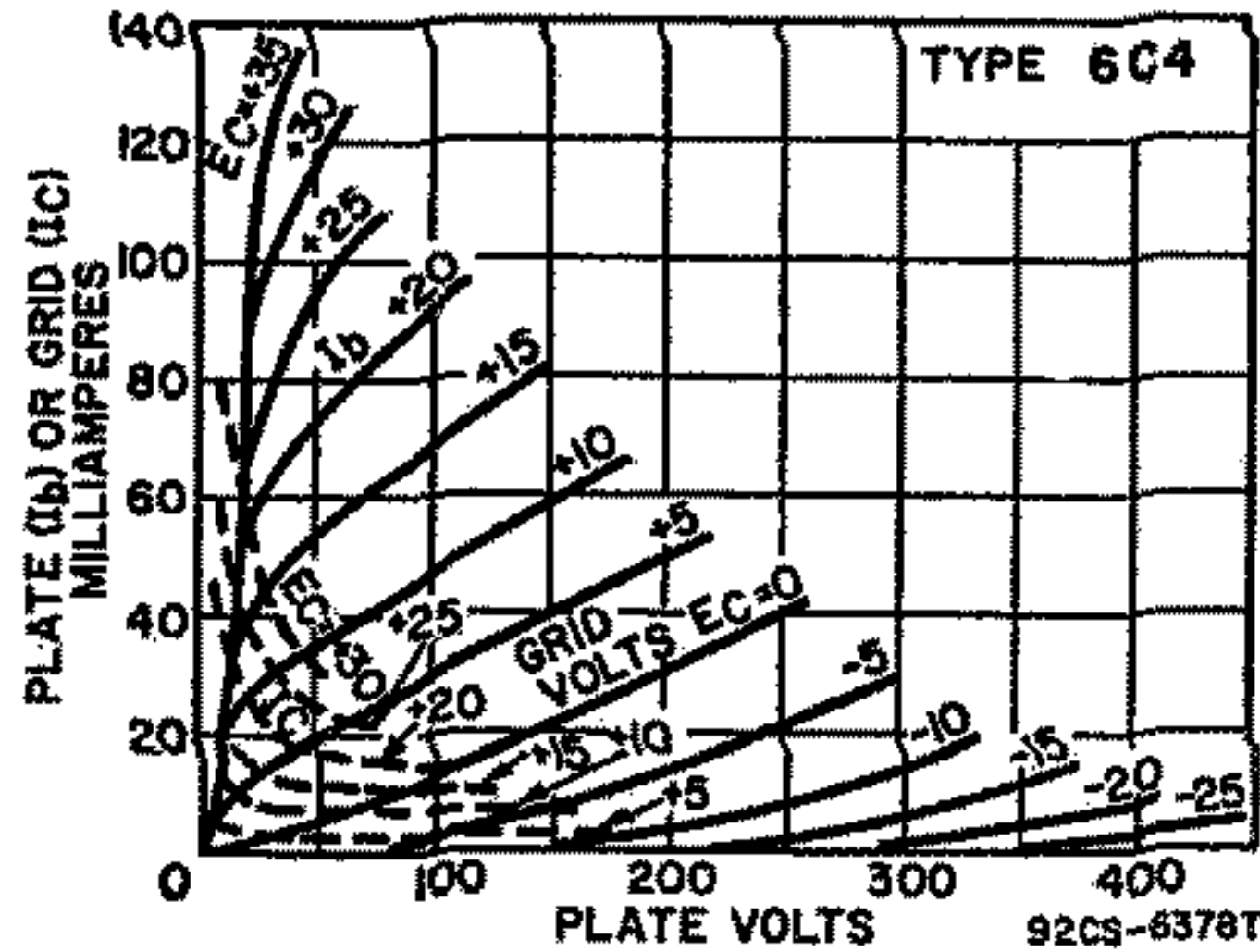
**RF Power Amplifier and Oscillator—Class C Telegraphy**

<b>MAXIMUM RATINGS (Design-Center Values)</b>		
Plate Voltage .....	800	volts
Grid Voltage .....	-80	volts
Plate Current .....	15	mA
Grid Current .....	3	mA
Plate Dissipation .....	5	watts

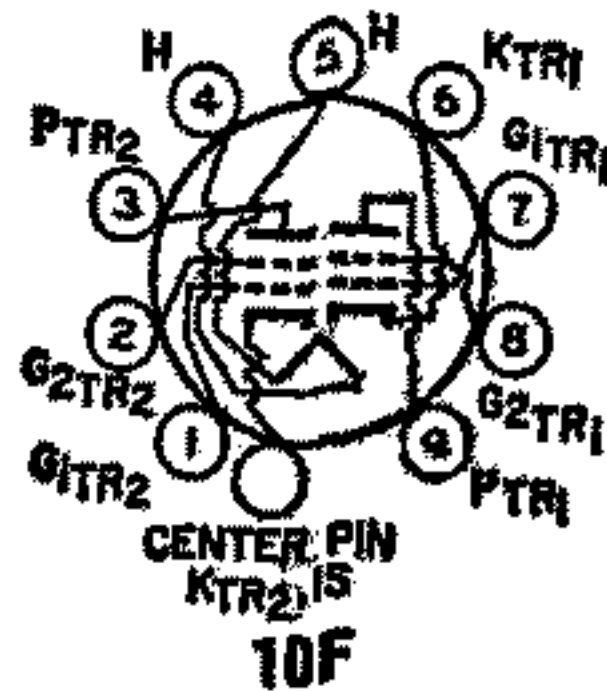
**TYPICAL OPERATION AT FREQUENCIES UP TO 50 MHz**

Plate Voltage .....	300	volts
Grid Voltage .....	-27	volts
Plate Current .....	25	mA
Grid Current (Approx.) .....	7	mA
Driving Power (Approx.) .....	0.35	watt
Power Output (Approx.) .....	5.5	watts

\* Approximately 2.5 watts power output can be obtained when the 6C4 is used at 150 MHz as an oscillator with grid resistor of 10,000 ohms and with maximum rated input.



- 6C5** Refer to chart at end of section.
- 6C5GT** Refer to chart at end of section.
- 6C6** Refer to chart at end of section.
- 6C7** Refer to chart at end of section.
- 6C8G** Refer to chart at end of section.



**SHARP-CUTOFF DUAL TETRODE**

**6C9**  
17C9

Miniature type used as vhf rf-amplifier and autodyne mixer tube. Outlines section, 6B; except center pin is added to base; requires miniature 10-contact socket. Type 17C9 is identical with type 6C9 except for heater ratings.

Heater Voltage (ac/dc) .....	6C9	17C9	
Heater Current .....	6.3	16.8	volts
Peak Heater-Cathode Voltage .....	0.4	0.15	ampere
Direct Interelectrode Capacitances:	±100 max	±100 max	volts
Grid No.1 to Plate .....	Unit No. 1	Unit No. 2	
Grid No.1 to Cathode, Heater, Grid No.2, and Internal Shield .....	0.055 max	0.06 max	pF
Plate to Cathode, Heater, Grid No.2 and Internal Shield .....	4.4	4.2	pF
Heater to Cathode .....	2.2	2.2	pF
Plate of Unit No.1 to Plate of Unit No.2 .....	4.2	4.8	pF
Grid No.1 of Unit No.1 to Grid No.1 of Unit No.2 .....	0.008 max		pF
Grid No.1 of Unit No.1 to Plate of Unit No.2 ..	0.001 max		pF
Grid No.1 of Unit No.2 to Plate of Unit No.1 ..	0.001 max		pF
	0.032 max		pF

**Class A<sub>1</sub> Amplifier (Each Unit)**

**MAXIMUM RATINGS (Design-Maximum Values)**

Plate Voltage .....	250	volts
Grid-No.2 (Screen-Grid) Supply Voltage .....	180	volts
Grid-No.2 Voltage .....	See curve page 96	
Cathode Current .....	20	mA

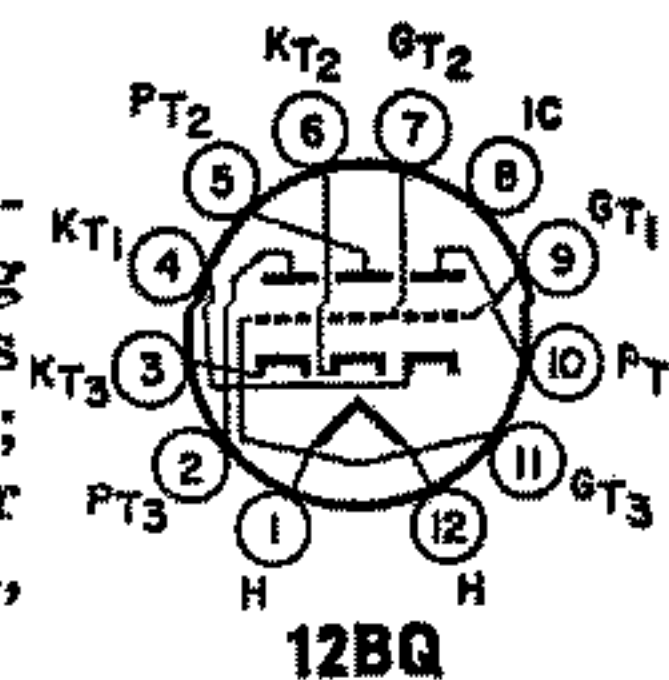
Plate Dissipation:		
Either plate .....	1.5	watts
Both plates (both units operating) .....	2.5	watts
Grid-No.2 Input:		
For grid-No.2 voltages up to 90 volts .....	0.5	watt
For grid-No.2 voltages between 90 and 180 volts .....	See curve page 96	

**CHARACTERISTICS**

Plate Voltage .....	125	volts
Grid-No.2 Voltage .....	80	volts
Grid-No.1 Voltage .....	-1	volt
Plate Resistance (Approx.) .....	0.1	megohm
Transconductance .....	8000	$\mu$ mhos
Plate Current .....	10	mA
Grid-No.2 Current .....	1.5	mA
Grid-No.1 Voltage (Approx.) for plate current of 20 $\mu$ A .....	-6	volts

## 6C10 HIGH-MU TRIPLE TRIODE

Duodecar type used in resistance-coupled voltage amplifiers, phase inverters, and other circuits requiring high voltage gain. Outlines section, 8A; requires duodecar 12-contact socket. Heater: volts (ac/dc), 6.3; amperes, 0.6; average warm-up time (for series heater operation), 11 seconds; maximum heater-cathode volts,  $\pm 200$  peak, 100 average.



### Class A<sub>1</sub> Amplifier

**MAXIMUM RATINGS (Design-Maximum Values, Each Triode Unit)**

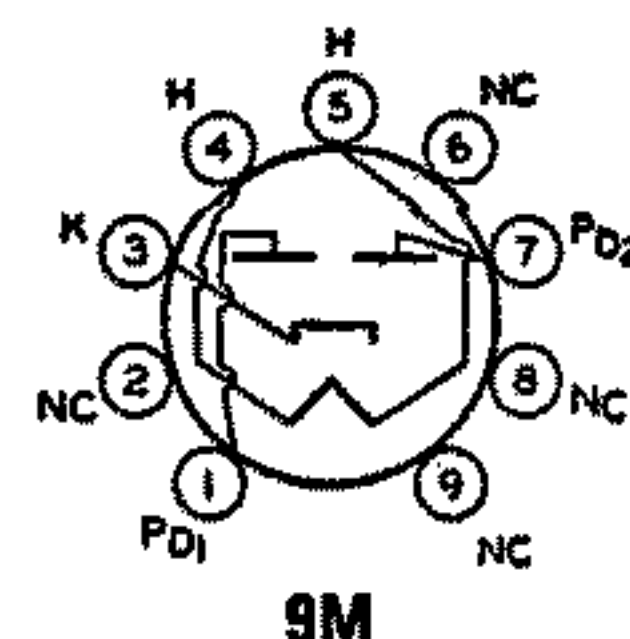
Plate Voltage .....	330	volts
Grid Voltage:		
Positive-bias value .....	0	volts
Negative-bias value .....	-50	volts
Plate Dissipation .....	1	watt
Total Plate Dissipation (All plates) .....	3	watts

**CHARACTERISTICS (Each Triode Unit)**

Plate Voltage .....	100	250	volts
Grid Voltage .....	-1	-2	volts
Amplification Factor .....	100	100	
Plate Resistance (Approx.) .....	80000	62500	ohms
Transconductance .....	1250	1600	$\mu$ mhos
Plate Current .....	0.5	1.2	mA

## 6CA4 FULL-WAVE VACUUM RECTIFIER

Miniature type used in power supply of compact audio equipment having moderate dc requirements. Outlines section, 6G; requires miniature 9-contact socket. This tube, like other power-handling tubes, should be adequately ventilated. Heater: volts (ac/dc), 6.3; amperes, 1.



### Full-Wave Rectifier

**MAXIMUM RATINGS (Design-Center Values)**

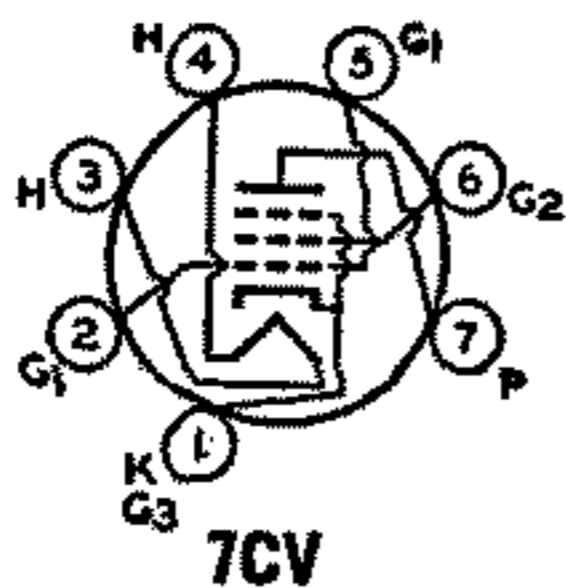
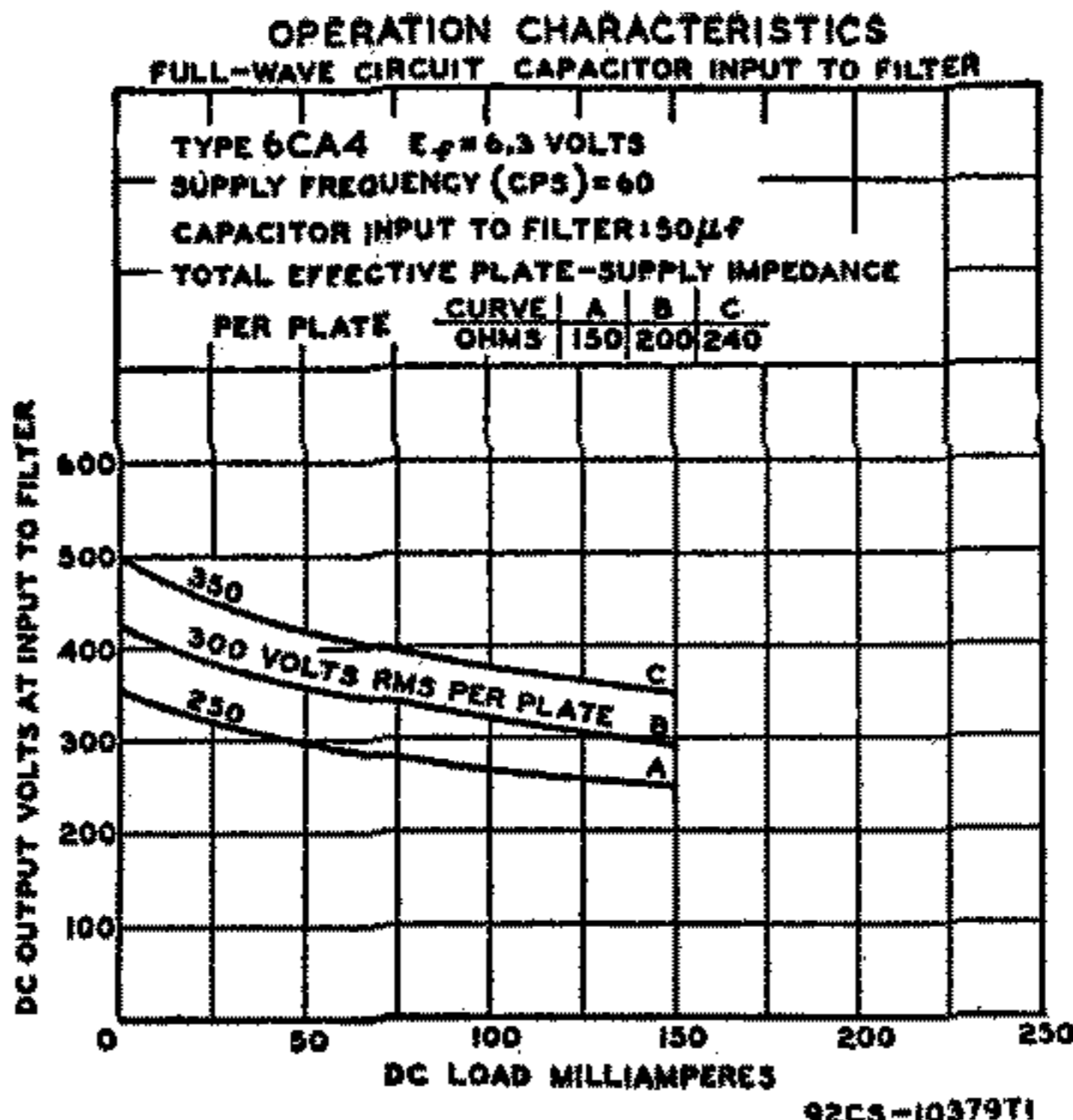
Peak Inverse Plate Voltage .....	1000	volts
Peak Plate Current (Per Plate) .....	450	mA
AC Plate Supply Voltage (Per Plate, rms) with Capacitor Input to Filter .....	350	volts
Average Output Current .....	150	mA
Hot Switching Transient Plate Current (Per Plate) .....	#	
Peak Heater-Cathode Voltage .....	-500	volts

**TYPICAL OPERATION WITH CAPACITOR INPUT TO FILTER**

AC Plate-to-Plate Supply Voltage (rms) .....	500	600	700	volts
Filter-Input Capacitor .....	50	50	50	$\mu$ F
Total Effective Plate Supply Impedance per Plate .....	150	200	240	ohms
DC Output Voltage at Input to Filter (Approx.) For dc output current of 150 mA .....	245	293	347	volts

# When capacitor-input circuits are used, a maximum peak current value per plate of 1 ampere during the initial cycles of the hot-switching transient should not be exceeded.





**BEAM POWER TUBE**

**6CA5**

12CA5, 25CA5

Miniature type used in af power output stage of radio and television receivers. Outlines section, 5D; requires miniature 7-contact socket. Types 12CA5 and 25CA5 are identical with type 6CA5 except for heater ratings.

	6CA5	12CA5	25CA5	
Heater Voltage (ac/dc) .....	6.3	12.6	25	volts
Heater Current .....	1.2	0.6	0.3	ampere
Heater Warm-up Time (Average) .....	—	11	—	seconds
<b>Heater-Cathode Voltage:</b>				
Peak value .....	$\pm 200$ max	+200 —300 max	$\pm 200$ max	volts
Average value .....	100 max	+100 —200 max	100 max	volts

**Class A<sub>1</sub> Amplifier**

**MAXIMUM RATINGS (Design-Center Values)**

Plate Voltage .....	130	volts
Grid-No.2 (Screen-Grid) Voltage .....	130	volts
Grid-No.1 (Control-Grid) Voltage, Positive-bias value .....	0	volts
Plate Dissipation .....	5	watts
Grid-No.2 Input .....	1.4	watts
Bulb Temperature (At hottest point) .....	180	$^{\circ}$ C

**TYPICAL OPERATION**

Plate Voltage .....	110	125	volts
Grid-No.2 Voltage .....	110	125	volts
Grid-No.1 (Control-Grid) Voltage .....	-4	-4.5	volts
Peak AF Grid-No.1 Voltage .....	4	4.5	volts
Zero-Signal Plate Current .....	32	37	mA
Maximum-Signal Plate Current .....	31	36	mA
Zero-Signal Grid-No.2 Current (Approx.) .....	3.5	4	mA
Maximum-Signal Grid-No.2 Current (Approx.) .....	7.5	11	mA
Plate Resistance (Approx.) .....	16000	15000	ohms
Transconductance .....	8100	9200	$\mu$ mhos
Load Resistance .....	3500	4500	ohms
Total Harmonic Distortion .....	5	6	per cent
Maximum-Signal Power Output .....	1.1	1.5	watts

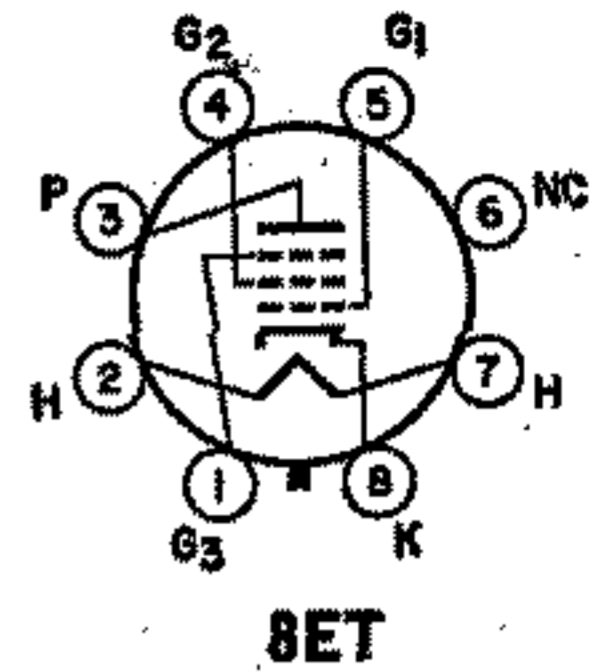
**MAXIMUM CIRCUIT VALUES**

<b>Grid-No.1-Circuit Resistance:</b>			
For fixed-bias operation .....	0.1	megohm	
For cathode-bias operation .....	0.5	megohm	

**6CA7**  
**6CA7/**  
**EL34**

**POWER PENTODE**

Glass octal types used in the output stage of audio-frequency amplifiers. Maximum dimensions: over-all length, 4<sup>7</sup>/<sub>16</sub> inches; seated height, 3<sup>7</sup>/<sub>8</sub> inches; diameter, 1<sup>1</sup>/<sub>2</sub> inches. Tubes require octal socket.



Heater Voltage (ac/dc)	6.3	volts
Heater Current	1.5	amperes
Peak Heater-Cathode Voltage	±200 max	volts
<b>Direct Interelectrode Capacitances:</b>		
Grid No.1 to Plate	1	pF
Grid No.1 to Cathode, Heater, Grid No.2, and Grid No.3	15.5	pF
Plate to Cathode, Heater, Grid No.2, and Grid No.3	7.2	pF

**Class A<sub>1</sub> Amplifier**

<b>MAXIMUM RATINGS (Design-Center Values)</b>		
Plate Voltage	800	volts
Grid-No.2 (Screen-Grid) Voltage	425	volts
Grid-No.2 Input	8	watts
Cathode Current	150	mA
Plate Dissipation	25	watts

**TYPICAL OPERATION**

Plate Voltage	265	volts
Grid-No.2 Voltage	250	volts
Grid-No.1 (Control-Grid) Voltage	-13.5	volts
Peak AF Grid-No.1 Voltage	12.3	volts
Zero-Signal Plate Current	100	mA
Zero-Signal Grid-No.2 Current	15	mA
Transconductance	11000	μmhos
Plate Resistance	15000	ohms
Load Resistance	2000	ohms
Maximum-Signal Power Output	11	watts
Total Harmonic Distortion	10	per cent

**MAXIMUM CIRCUIT VALUE**

Grid-No.1-Circuit Resistance, For cathode-bias operation	0.7	megohm
--	-----	--------

**Push-Pull Class AB<sub>1</sub> Amplifier**

**MAXIMUM RATINGS (Same as for Class A<sub>1</sub> Amplifier)**

**TYPICAL OPERATION (Values are for two tubes)**

Plate Supply Voltage	450	volts
Grid-No.2 Supply Voltage	450	volts
Cathode-Bias Resistor	232	ohms
Grid-No.2 Resistor	1000	ohms
Peak AF Grid-No.1 to Grid-No.1 Voltage	38.2	volts
Zero-Signal Plate Current	120	mA
Maximum-Signal Plate Current	143	mA
Zero-Signal Grid-No.2 Current	20	mA
Maximum-Signal Grid-No.2 Current	44	mA
Effective Load Resistance (Plate-to-plate)	6500	ohms
Total Harmonic Distortion	5.1	per cent
Maximum-Signal Power Output	40	watts

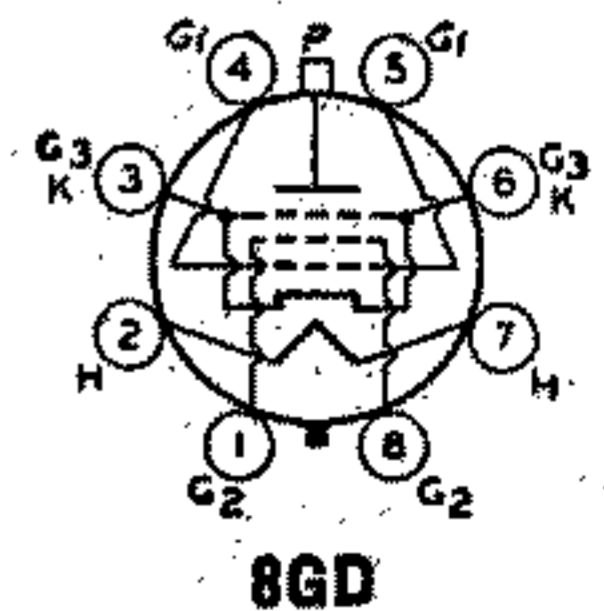
**6CB5**

Refer to chart at end of section.

**6CB5A**

**BEAM POWER TUBE**

Glass octal type used as horizontal-deflection amplifier in color and black-and-white television receivers. Outlines section, 21B; requires octal socket.



Heater Voltage (ac/dc)	6.3	volts
Heater Current	2.5	amperes

<b>Heater-Cathode Voltage:</b>		
Peak value .....	±200 max	volts
Average value .....	100 max	volts
<b>Direct Interelectrode Capacitances (Approx.):</b>		
Grid No.1 to Plate .....	0.4	pF
Grid No.1 to Cathode, Heater, Grid No.2, and Grid No.3 .....	22	pF
Plate to Cathode, Heater, Grid No.2, and Grid No.3 .....	10	pF

**Class A<sub>1</sub> Amplifier**

<b>CHARACTERISTICS</b>			
Plate Voltage .....	75	175	volts
Grid-No.2 Voltage .....	150	175	volts
Grid-No.1 Voltage .....	0	-30	volts
Mu-Factor, Grid No.2 to Grid No.1 .....	—	3.8	
Plate Resistance (Approx.) .....	—	5000	ohms
Transconductance .....	—	8800	amhos
Plate Current .....	460*	90	mA
Grid-No.2 Current .....	42*	6	mA
Grid-No.1 Voltage (Approx.) for plate current of 1 mA .....	—	-60	volts

\* These values can be measured by a method involving a recurrent waveform such that the maximum rating of the tube will not be exceeded.

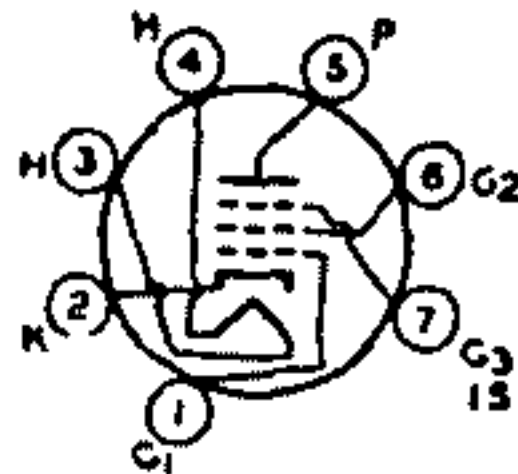
**Horizontal-Deflection Amplifier**

For operation in a 525-line, 30-frame system

<b>MAXIMUM RATINGS (Design-Maximum Values)</b>		
DC Plate Voltage .....	880	volts
Peak Positive-Pulse Plate Voltage# .....	6900	volts
Peak Negative-Pulse Plate Voltage .....	-1650	volts
DC Grid-No.2 (Screen-Grid) Voltage .....	220	volts
DC Grid-No.1 (Control-Grid) Voltage .....	-55	volts
Peak Negative-Pulse Grid-No.1 Voltage .....	-220	volts
Peak Cathode Current .....	850	mA
Average Cathode Current .....	240	mA
Grid-No.2 Input .....	4	watts
Plate Dissipation† .....	26	watts
Bulb Temperature (At hottest point) .....	220	°C

<b>MAXIMUM CIRCUIT VALUE</b>		
Grid-No.1-Circuit Resistance .....	0.47	megohm

# Pulse duration must not exceed 15% of a horizontal scanning cycle (10 microseconds).  
 † A bias resistor or other means is required to protect the tube in absence of excitation.



7CM

**6CB6**  
**6CB6A**  
 3CB6, 4CB6

**SHARP-CUTOFF PENTODE**

Miniature types used in color and black-and-white television receivers as if amplifier at frequencies up to about 45 MHz and as rf amplifiers in vhf television tuners. Outlines section, 5C; require miniature 7-contact socket. For typical operation as resistance-coupled amplifiers, refer to Resistance-Coupled Amplifier section. Types 3CB6, 4CB6, and 6CB6 are identical with type 6CB6A except for heater ratings.

	<b>3CB6</b>	<b>4CB6</b>	<b>6CB6</b>	<b>6CB6A</b>	
Heater Voltage (ac/dc) .....	3.15	4.2	6.3	6.3	volts
Heater Current .....	0.6	0.45	0.3	0.3	ampere
Heater Warm-up Time (Average) .....	11	11	—	11	seconds
<b>Heater-Cathode Voltage:</b>					
Peak value .....	{ +200 max -300 max	{ +200 max -300 max	±200 max		volts
Average value .....	100 max	{ +100 max -200 max	100 max		volts
<b>Direct Interelectrode Capacitances:</b>					
Grid No.1 to Plate .....			Unshielded	Shielded <sup>a</sup>	
Grid No.1 to Cathode, Heater, Grid No.2, Grid No.3, and Internal Shield .....			0.025 max	0.015 max	pF
Plate to Cathode, Heater, Grid No.2, Grid No.3, and Internal Shield .....			6.5	6.5	pF
			2	2	pF

<sup>a</sup> With external shield connected to cathode.



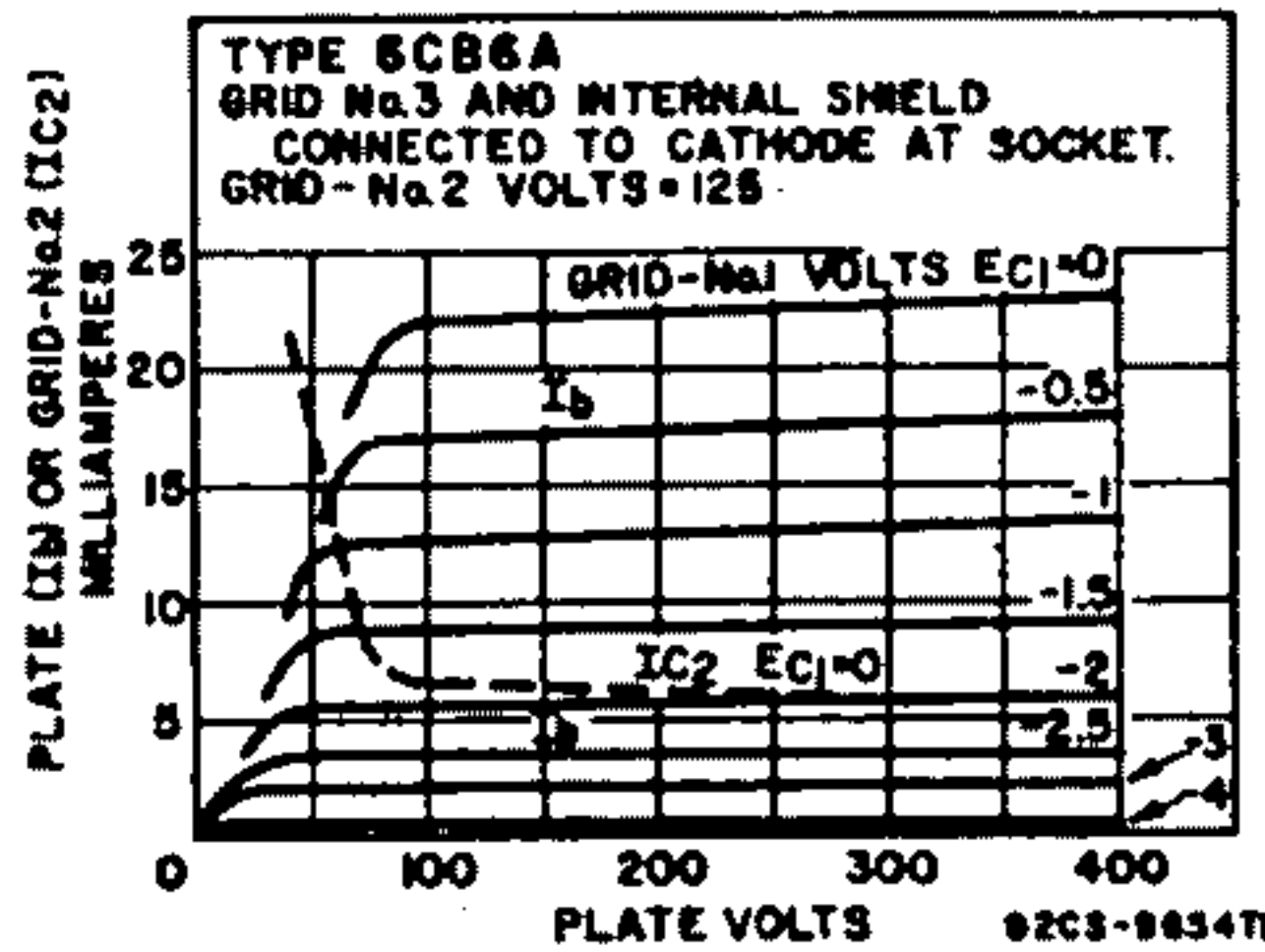
**Class A<sub>1</sub> Amplifier**

**MAXIMUM RATINGS (Design-Maximum Values)**

Plate Voltage .....	330	volts
Grid-No.3 (Suppressor-Grid) Voltage, Positive value .....	0	volts
Grid-No.2 (Screen-Grid) Voltage .....	See curve page 96	
Grid-No.2 Supply Voltage .....	330	volts
Grid-No.1 (Control-Grid) Voltage, Positive-bias value .....	0	volts
Plate Dissipation .....	2.8	watts
Grid-No.2 Input:		
For grid-No.2 voltages up to 165 volts .....	0.55	watt
For grid-No.2 voltages between 165 and 330 volts .....	See curve page 96	

**CHARACTERISTICS**

Plate Supply Voltage .....	125	volts
Grid No.3 .....	Connected to cathode at socket	
Grid-No.2 Supply Voltage .....	125	volts
Cathode-Bias Resistor .....	56	ohms
Plate Resistance (Approx.) .....	0.28	megohm
Transconductance .....	8000	ambos
Plate Current .....	13	mA
Grid-No.2 Current .....	3.7	mA
Grid-No.1 Voltage (Approx.) for plate current of 20 $\mu$ A .....	-8.5	volts
Grid-No.1 Voltage (Approx.) for plate current of 2.8 mA .....	-3	volts



**6CD6G**

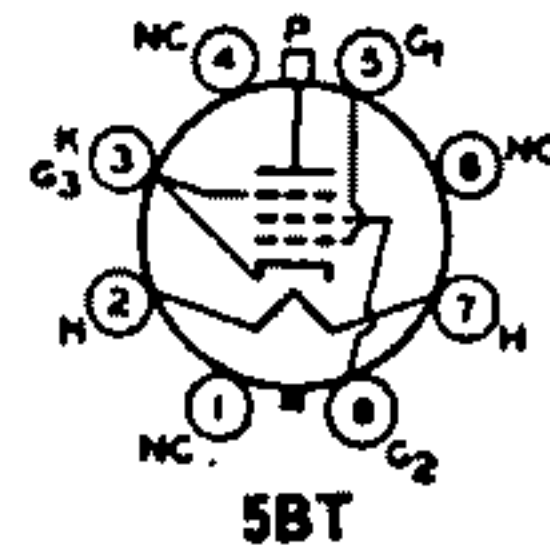
Refer to chart at end of section.

**6CD6GA**

25CD6GB

**BEAM POWER TUBE**

Glass octal type used as horizontal-deflection amplifier in high-efficiency deflection circuits of color and black-and-white television receivers. Outlines section, 21B; requires octal socket. This type may be supplied with pins 1, 4, and 6 omitted. Vertical tube mounting is preferred, but horizontal operation is permissible if pins No.2 and 7 are in vertical plane. Type 25CD6GB is identical with type 6CD6GA except for heater ratings.



Heater Voltage (ac/dc) .....	6CD6GA	25CD6GB	
Heater Current .....	6.3	25	volts
Heater Warm-up Time (Average) .....	2.5	0.6	amperes
Heater-Cathode Voltage:		11	seconds
Peak value .....	$\pm 200$ max	$\pm 200$ max	volts
Average value .....	100 max	100 max	volts
Direct Interelectrode Capacitances (Approx.):			
Grid No.1 to Plate .....		1.1	pF
Grid No.1 to Cathode, Heater, Grid No.2, and Grid No.3 .....		22	pF
Plate to Cathode, Heater, Grid No.2, and Grid No.3 .....		8.5	pF

**Class A<sub>1</sub> Amplifier**

**CHARACTERISTICS**

Plate Voltage	60	175	volts
Grid-No.2 (Screen-Grid) Voltage	100	175	volts
Grid-No.1 (Control-Grid) Voltage	0	-30	volts
Mu-Factor, Grid No.2 to Grid No.1	—	3.9	
Plate Resistance (Approx.)	—	7200	ohms
Transconductance	—	7700	μmhos
Plate Current	230*	5.5	mA
Grid-No.2 Current	21*	5.5	mA
Grid-No.1 Voltage (Approx.) for plate current of 1 mA	—	-55	volts

\* This value can be measured by a method involving a recurrent waveform such that the maximum ratings of the tube will not be exceeded.

**Horizontal-Deflection Amplifier**

For operation in a 525-line, 30-frame system

**MAXIMUM RATINGS (Design-Center Values)**

DC Plate Voltage	700	volts
Peak Positive-Pulse Plate Voltage# (Absolute Maximum)	7000*	volts
Peak Negative-Pulse Plate Voltage	-1500	volts
DC Grid-No.2 (Screen-Grid) Voltage	175	volts
Peak Negative-Pulse Grid-No.1 Voltage	700	volts
Peak Cathode Current	200	mA
Average Cathode Current	-200	mA
Plate Dissipation†	20	watts
Grid-No.2 Input	3	watts
Bulb Temperature (At hottest point)	225	°C

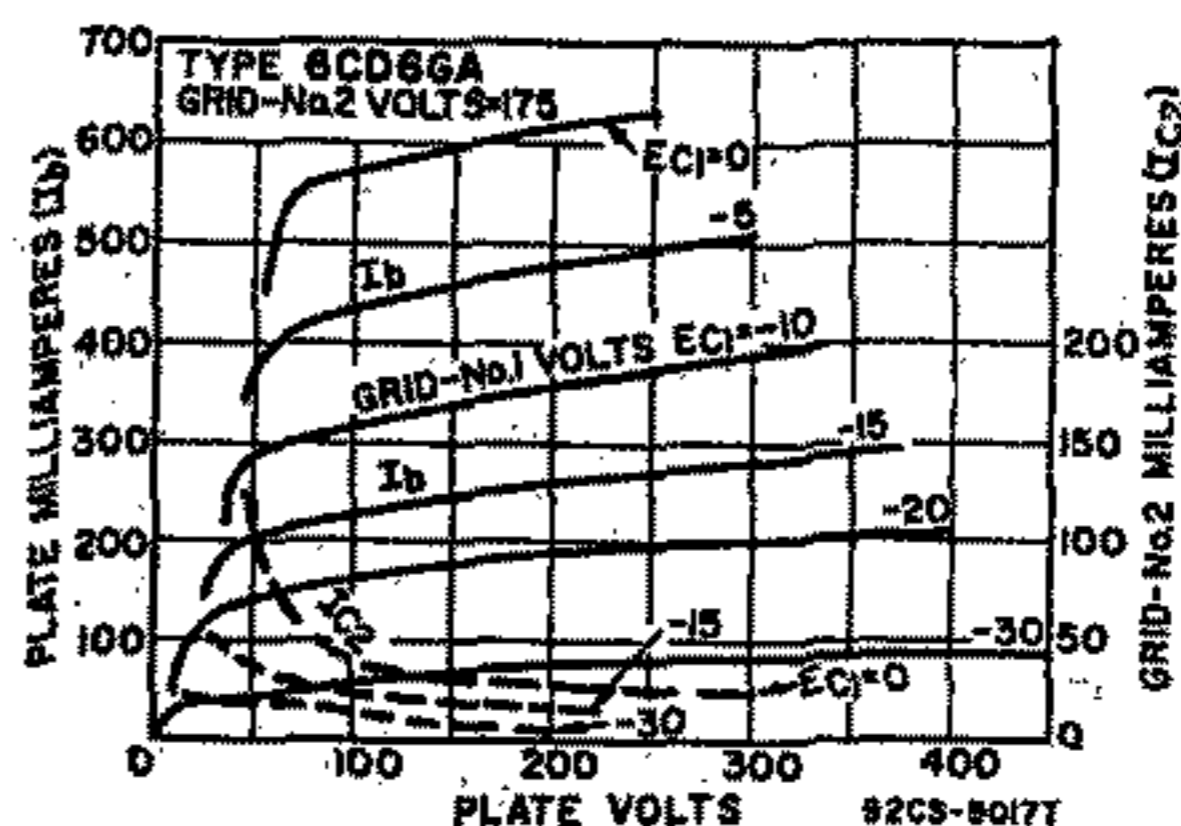
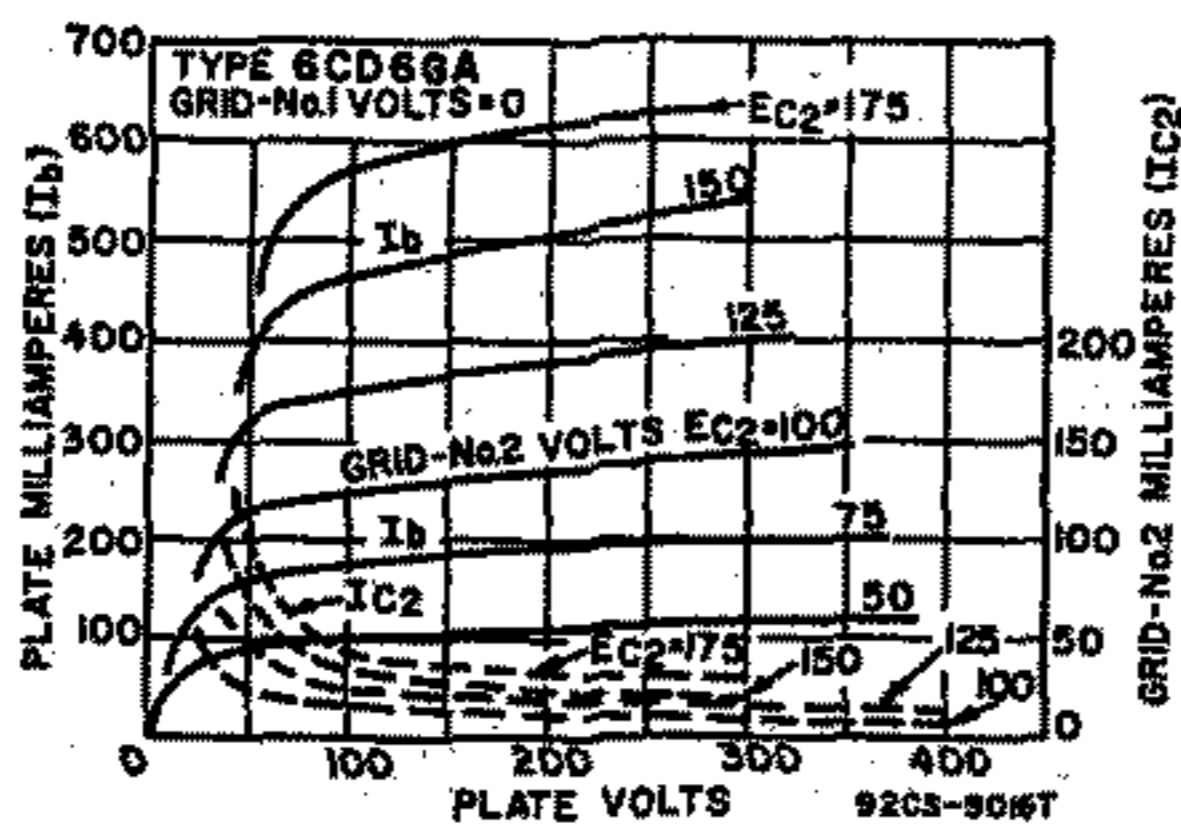
**MAXIMUM CIRCUIT VALUE**

Grid-No.-Circuit Resistance, for grid-resistor-bias operation ..... 0.47 megohm

# Pulse duration must not exceed 15% of a horizontal scanning cycle (10 microseconds).

\* Under no circumstances should this absolute value be exceeded.

† A bias resistor or other means is required to protect the tube in absence of excitation.



7BD

**SHARP-CUTOFF PENTODE**

Miniature type used as rf and if amplifier in vhf television receivers. Outlines section, 5C; requires miniature 7-contact socket. Type 3CE5 is identical with type 6CE5 except for heater ratings.

**6CE5**

3CE5

Heater Voltage (ac/dc)	3.15	6.3	volts
Heater Current	0.6	0.3	ampere
Heater Warm-up Time (Average)	11	11	seconds
Heater-Cathode Voltage:			
Peak value	±200 max	±200 max	volts
Average value	100 max	100 max	volts

Direct Interelectrode Capacitances:		
Grid No.1 to Plate .....	0.03 max	pF
Grid No.1 to Cathode, Heater, Grid No.2, Grid No.3, and Internal Shield .....	6.5	pF
Plate to Cathode, Heater, Grid No.2, Grid No.3, and Internal Shield .....	1.9	pF

**Class A<sub>1</sub> Amplifier**

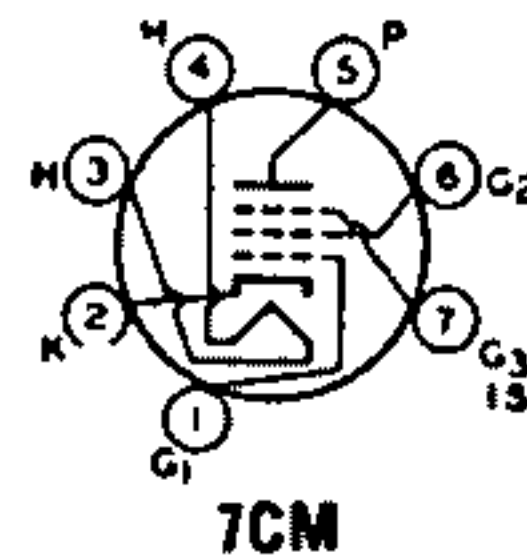
<b>MAXIMUM RATINGS (Design-Center Values)</b>		
Plate Voltage .....	300	volts
Grid-No.2 (Screen-Grid) Voltage .....	150	volts
Grid-No.1 (Control-Grid) Voltage, Positive-bias value .....	0	volts
Plate Dissipation .....	2	watts
Grid-No.2 Input .....	0.5	watt

<b>CHARACTERISTICS</b>		
Plate Voltage .....	125	volts
Grid-No.2 Voltage .....	125	volts
Grid-No.1 Supply Voltage .....	-1	volt
Grid-No.1 Resistor (Bypassed) .....	1	megohm
Plate Resistance (Approx.) .....	0.8	megohm
Transconductance .....	7800	μmhos
Plate Current .....	11	mA
Grid-No.2 Current .....	2.3	mA
Grid-No.1 Voltage (Approx.) for plate current of 35 μA .....	-5	volts

**6CF6**  
3CF6

**SHARP-CUTOFF PENTODE**

Miniature type used in television receivers as an if amplifier at frequencies up to about 45 MHz and as an rf amplifier in vhf television tuners. This type is electrically similar to type 6CB6. Outlines section, 5C; requires 7-contact socket. Type 3CF6 is identical with type 6CF6 except for heater ratings.



	3CF6	6CF6	
Heater Voltage (ac/dc) .....	3.15	6.3	volts
Heater Current .....	0.6	0.3	ampere
Heater Warm-up Time (Average) .....	11	11	seconds
Heater-Cathode Voltage:			
Peak value .....	+200, -300 max	±200 max	volts
Average value .....	100 max	100 max	volts

Direct Interelectrode Capacitances:			
	Unshielded	Shielded	
Grid No.1 to Plate .....	0.025 max	0.015 max	pF
Grid No.1 to Cathode, Heater, Grid No.2, Grid No.3, and Internal Shield .....	6.5	6.5	pF
Plate to Cathode, Heater, Grid No.2, Grid No.3, and Internal Shield .....	2	2	pF

<b>CHARACTERISTICS</b>		
Plate Supply Voltage .....	125	volts
Grid No.3 .....	Connected to cathode at socket	
Grid-No.2 Supply Voltage .....	125	volts
Cathode-Bias Resistor .....	58	ohms
Plate Resistance (Approx.) .....	0.8	megohm
Transconductance .....	7800	μmhos
Plate Current .....	12.5	mA
Grid No.2 Current .....	3.7	mA
Grid-No.1 Voltage (Approx.) for plate current of 20 μA .....	-6	volts
Grid-No.1 Voltage (Approx.) for plate current of 2.2 mA .....	-3	volts

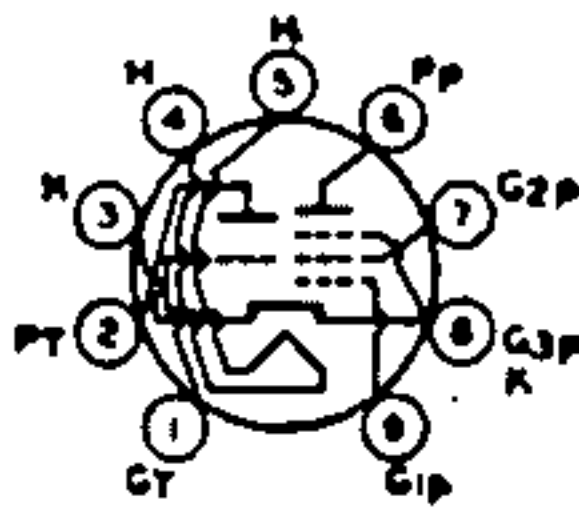
**6CG7**

Refer to type 6FQ7/6CG7.

**6CG8**

Refer to chart at end of section.





6GF

**MEDIUM-MU TRIODE—  
SHARP-CUTOFF PENTODE**

**6CG8A**  
5CG8

Miniature type used as combined oscillator and mixer tube in color and black-and-white television receivers utilizing an intermediate frequency in the order of 40 MHz. When used in an AM/FM receiver, the triode unit is used as an oscillator for both sections. In the AM section, the pentode unit is used as a high-gain pentode mixer; in the FM section, the pentode unit is used either as a pentode mixer or as a triode-connected mixer depending on signal-to-noise considerations. Outlines section, 6B; requires miniature 9-contact socket. Type 5CG8 is identical with type 6CG8A except for heater ratings. These types are electrically identical with miniature type 6X8 except for inter-electrode capacitances.

	5CG8	6CG8A	
Heater Voltage (ac/dc)	4.7	6.3	volts
Heater Current	0.6	0.45	amperes
Heater Warm-up Time (Average)	11	11	seconds
Heater-Cathode Voltage:			
Peak value	±200 max	±200 max	volts
Average value	100 max	100 max	volts
Direct Interelectrode Capacitances:	Unshielded	Shielded*	
Triode Unit:			
Grid to Plate	1.5	1.5	pF
Grid to Cathode, Heater, and Pentode Grid No.3	2	2.4	pF
Plate to Cathode, Heater, and Pentode Grid No.3	0.5	1	pF
Pentode Unit:			
Grid No.1 to Plate	0.04 max	0.02 max	pF
Grid No.1 to Cathode, Heater, Grid No.2, and Grid No.3	4.6	4.8	pF
Plate to Cathode, Heater, Grid No.2, and Grid No.3	0.9	1.6	pF
Pentode Grid No.1 to Triode Plate	0.05 max	0.04 max	pF
Pentode Plate to Triode Plate	0.05 max	0.008 max	pF
Heater to Cathode	6.5	6.5*	pF

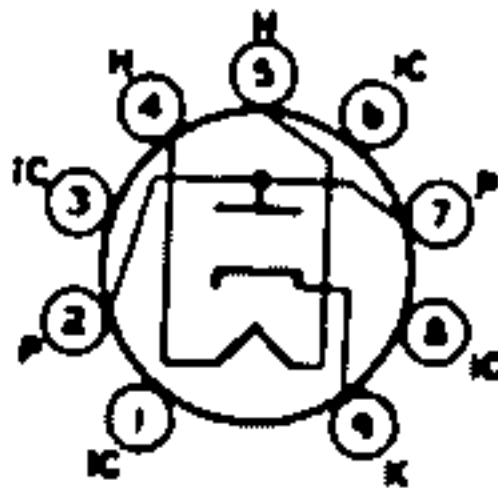
\* With external shield connected to cathode, except as noted.  
 \* With external shield connected to plate.

See chart at end of section.

6CH8

**HALF-WAVE  
VACUUM RECTIFIER**

**6CK3**  
12CK3, 17CK3



9HP

Novar type used as damper tube in horizontal-deflection circuits of black-and-white television receivers. Outlines section, 11D; requires novar 9-contact socket. Socket terminals 1, 3, 6, and 8 should not be used as tie points; it is recommended that socket tabs be removed to reduce the possibility of arc-over and to minimize leakage. This tube, like other power-handling tubes, should be adequately ventilated. Types 12CK3 and 17CK3 are identical with type 6CK3 except for heater ratings.

	6CK3	12CK3	17CK3	
Heater Voltage (ac/dc)	6.3	12.6	16.8	volts
Heater Current	1.2	0.6	0.45	amperes
Heater Warm-up Time (Average)	—	11	11	seconds
Direct Interelectrode Capacitances (Approx.):				
Plate to Cathode and Heater			6.5	pF
Cathode to Plate and Heater			9.0	pF
Heater to Cathode			2.0	pF

**Damper Service**

For operation in a 525-line, 30-frame system

<b>MAXIMUM RATINGS (Design-Maximum Values)</b>			
Peak Inverse Plate Voltage#	5200		volts
Peak Plate Current	1200		mA
Average Plate Current	250		mA
Plate Dissipation	6.5		watts
<b>Heater-Cathode Voltage:</b>			
Peak value	+300	-5200	volts
Average value	+100	-900	volts

<b>CHARACTERISTICS</b>			
Tube Voltage Drop for plate current of 350 mA	16		volts

# Pulse duration must not exceed 15% of a horizontal scanning cycle (10 microseconds).

**6CK4**

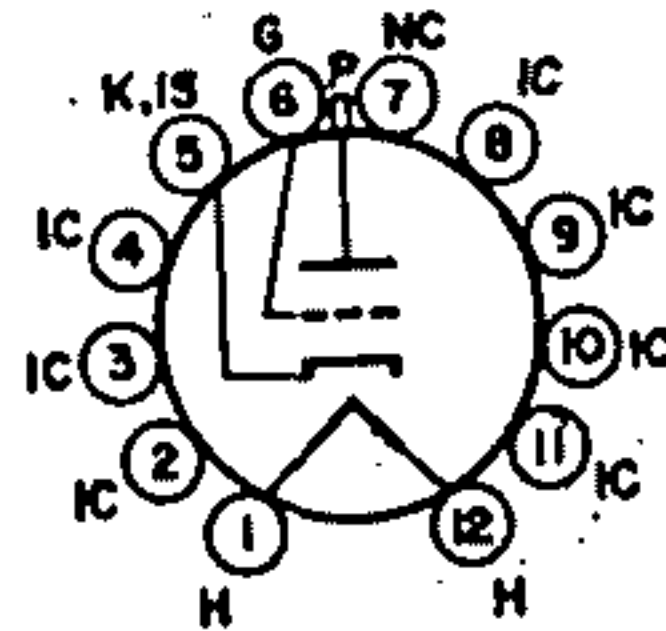
See chart at end of section.

**6CL3**

12CL3, 17CL3

**HALF-WAVE VACUUM RECTIFIER**

Novar type used as a damper tube in horizontal-deflection circuits of color and black-and-white television receivers. Outlines section, 30B; requires novar 9-contact socket. Socket terminals 1, 3, 6, and 8 should not be used as tie points. This tube, like other power-handling tubes, should be adequately ventilated. Types 12CL3 and 17CL3 are identical with type 6CL3 except for heater ratings.



**9HP**

	<b>6CL3</b>	<b>12CL3</b>	<b>17CL3</b>	
Heater Voltage (ac/dc)	6.3	12.6	16.8	volts
Heater Current	1.2	0.6	0.45	amperes
Heater Warm-up Time (Average)	—	11	11	seconds
<b>Direct Interelectrode Capacitances:</b>				
Plate to Cathode and Heater			6.5	pF
Cathode to Plate and Heater			9.0	pF
Heater to Cathode			3.0	pF

**Damper Service**

For operation in a 525-line, 30-frame system

<b>MAXIMUM RATINGS (Design-Maximum Values)</b>			
Peak Inverse Plate Voltage#	5500		volts
Peak Plate Current	1300		mA
Average Plate Current	250		mA
Plate Dissipation	8.5		watts
Bulb Temperature (At hottest point)	220		°C
<b>Heater-Cathode Voltage:</b>			
Peak value	+300	-5000	volts
Average value	+100	-900	volts

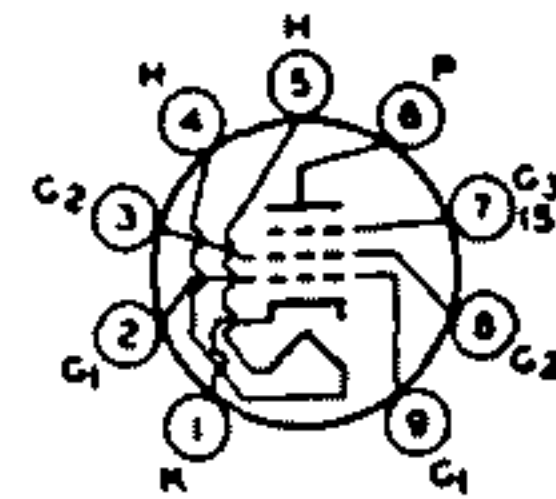
<b>CHARACTERISTICS</b>			
Tube Voltage Drop for plate current of 350 mA	16		volts

# Pulse duration must not exceed 15% of a horizontal scanning cycle (10 microseconds).

**6CL6**

**POWER PENTODE**

Miniature type used in output stage of video amplifier of color and black-and-white television receivers and as wide-band amplifier tube in industrial and laboratory equipment. Outlines section, 6E; requires miniature 9-contact socket.



**9BV**

Heater Voltage (ac/dc)	6.3		volts
Heater Current	0.65		ampere
Peak Heater-Cathode Voltage	±100 max		volts
<b>Direct Interelectrode Capacitances (Approx.):</b>			
Grid No.1 to Plate	0.12		pF

Grid No.1 to Cathode, Heater, Grid No.2, Grid No.3, and Internal Shield .....	11	pF
Plate to Cathode, Heater, Grid No.2, Grid No.3, and Internal Shield .....	5.5	pF

**Class A<sub>1</sub> Amplifier**

**MAXIMUM RATINGS (Design-Center Values)**

Plate Voltage .....	300	volts
Grid-No.3 (Suppressor-Grid) Voltage, Positive value .....	0	volts
Grid-No.2 (Screen-Grid) Supply Voltage .....	300	volts
Grid-No.2 Voltage .....	150	volts
Grid-No.1 (Control-Grid) Voltage:		
Negative-bias value .....	-50	volts
Positive-bias value .....	0	volts
Plate Dissipation .....	7.5	watts
Grid-No.2 Input .....	1.7	watts
Bulb Temperature (At hottest point) .....	200	°C

**TYPICAL OPERATION**

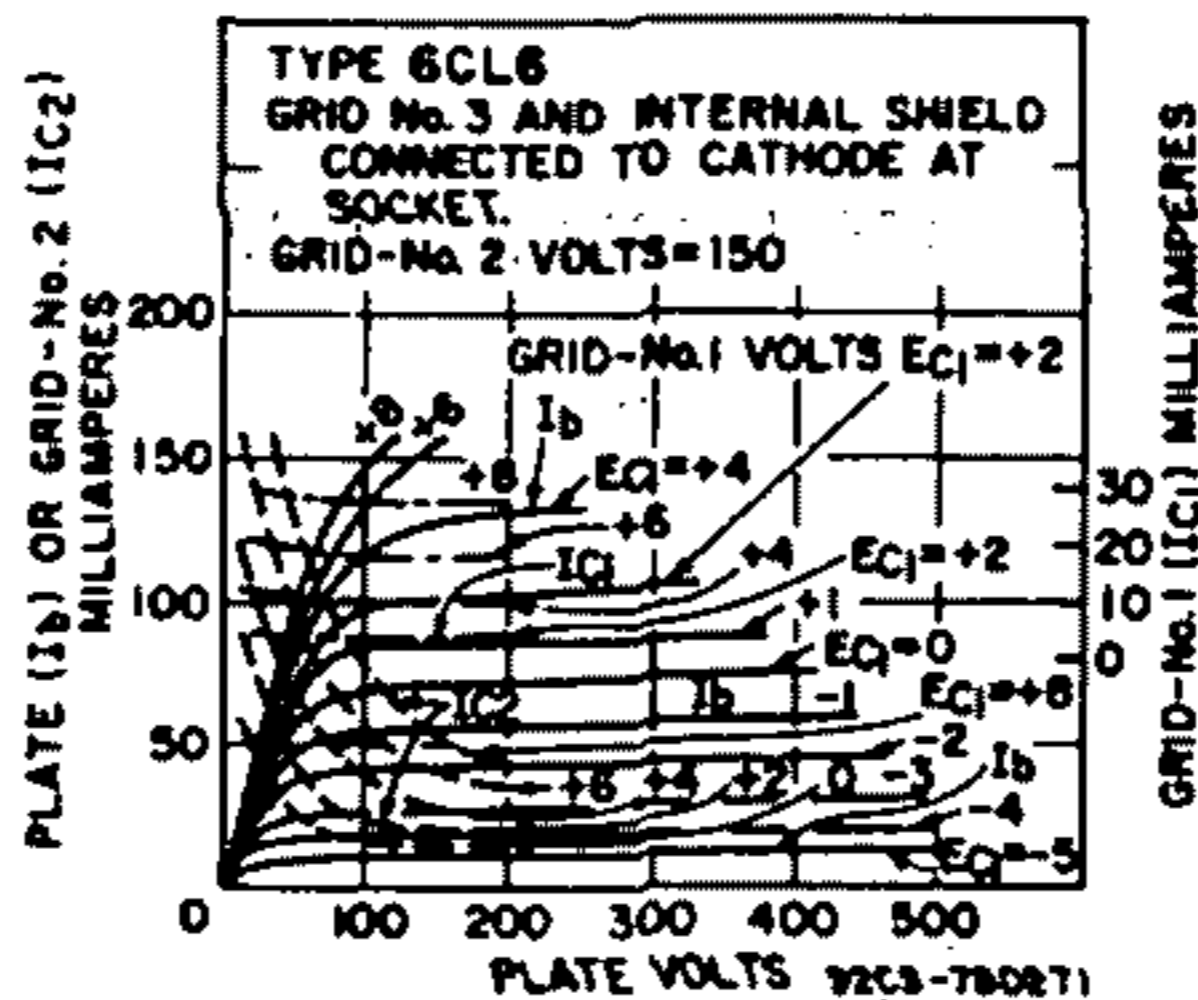
Plate Voltage .....	250	volts
Grid No.3 .....	Connected to cathode at socket	
Grid-No.2 Voltage .....	150	volts
Grid-No.1 Voltage .....	-8	volts
Peak AF Grid-No.1 Voltage .....	3	volts
Zero-Signal Plate Current .....	30	mA
Maximum-Signal Plate Current .....	31	mA
Zero-Signal Grid-No.2 Current .....	7	mA
Maximum-Signal Grid-No.2 Current .....	7.2	mA
Plate Resistance (Approx.) .....	0.09	megohm
Transconductance .....	11000	μmhos
Load Resistance .....	7500	ohms
Total Harmonic Distortion .....	8	per cent
Maximum-Signal Power Output .....	2.8	watts
Grid-No.1 Voltage (Approx.) for plate current of 10 μA .....	-14	volts

**TYPICAL OPERATION IN MH-BANDWIDTH VIDEO AMPLIFIER**

Plate Supply Voltage .....	300	volts
Grid No.3 .....	Connected to cathode at socket	
Grid-No.2 Supply Voltage .....	300	volts
Grid-No.1 Bias Voltage .....	-2	volts
Grid-No.1 Signal Voltage (Peak to Peak) .....	8	volts
Grid-No.2 Resistor .....	24000	ohms
Grid-No.1 Resistor .....	0.1	megohm
Load Resistor .....	3900	ohms
Zero-Signal Plate Current .....	30	mA
Zero-Signal Grid-No.2 Current .....	7.0	mA
Voltage Output (Peak to Peak) .....	132	volts

**MAXIMUM CIRCUIT VALUES**

Grid-No.1 Circuit Resistance:		
For fixed-bias operation .....	0.1	megohm
For cathode-bias operation .....	0.6	megohm



Refer to chart at end of section.

6CL8

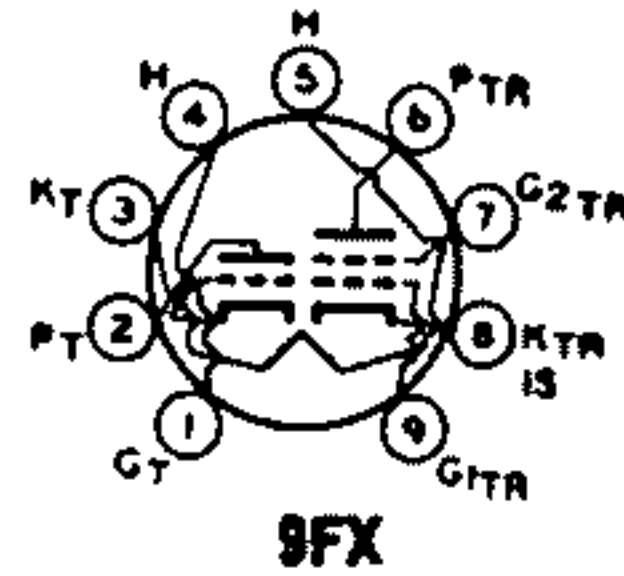


# 6CL8A

5CL8A, 19CL8A

## MEDIUM-MU TRIODE— SHARP-CUTOFF TETRODE

Miniature type used as combined vhf oscillator and mixer in color and black-and-white television receivers. Outlines section, 6B; requires miniature 9-contact socket. For maximum ratings as class A<sub>1</sub> amplifier, see type 6U8A. Types 5CL8A and 19CL8A are identical with type 6CL8A except for heater ratings.



	5CL8A	6CL8A	19CL8A	
Heater Voltage (ac/dc)	4.7	6.8	18.9	volts
Heater Current	0.6	0.45	0.15	ampere
Heater Warm-up Time (Average)	11	11	11	seconds
Heater-Cathode Voltage:				
Peak value	±200 max	±200 max	±200 max	volts
Average value	100 max	100 max	100 max	volts
Direct Interelectrode Capacitances:				
Triode Unit:				
Grid to Plate		1.8	1.8	pF
Grid to Cathode, Tetrode Cathode, Heater, and Internal Shield		2.8	2.8	pF
Plate to Cathode, Tetrode Cathode, Heater, and Internal Shield		1.5	2	pF
Tetrode Unit:				
Grid No. 1 to Plate		0.02 max	0.01 max	pF
Grid No.1 to Cathode, Heater, Grid No.2, and Internal Shield		5	5	pF
Plate to Cathode, Heater, Grid No.2, and Internal Shield		2	3	pF
Tetrode Grid No.1 to Triode Plate		0.015 max	0.01 max	pF
Tetrode Plate to Triode Plate		0.15 max	0.03 max	pF
Heater to Cathode (Each Unit)		3	3	pF

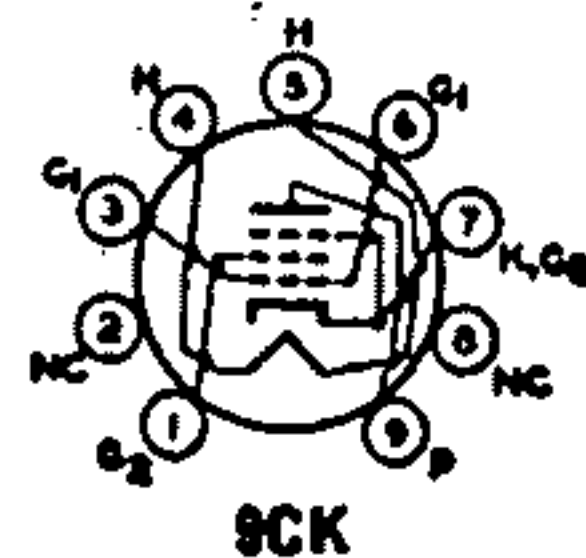
### Class A<sub>1</sub> Amplifier

CHARACTERISTICS	Triode Unit	Tetrode Unit	
Plate Supply Voltage	125	125	volts
Grid-No.2 (Screen-Grid) Voltage	—	125	volts
Grid-No.1 Voltage	—1	—1	volt
Amplification Factor	40	—	
Plate Resistance (Approx.)	0.005	0.2	megohm
Transconductance	8000	6500	ambos
Plate Current	14	12	mA
Grid-No.2 Current	—	4	mA
Grid-No.1 Voltage (Approx.) for plate current of 20 mA	—9	—9	volts
MAXIMUM CIRCUIT VALUES			
Grid-No.1-Circuit Resistance:			
For fixed-bias operation	0.5	0.25	megohm
For cathode-bias operation	1	1	megohm

# 6CM6

## BEAM POWER TUBE

Miniature type used as vertical-deflection amplifier in color and black-and-white television receivers and as audio power amplifier in radio and television receivers. Outlines section, 6E; requires miniature 9-contact socket. For typical operation and maximum circuit values as class A<sub>1</sub> amplifier, refer to type 6V6GTA. For curves of average plate characteristics, refer to type 6AQ5A.



Heater Voltage (ac/dc)	6.3	volts
Heater Current	0.45	ampere
Heater-Cathode Voltage:		
Peak value	±200 max	volts
Average value	100 max	volts
Direct Interelectrode Capacitances:		
Grid No.1 to Plate	0.7	pF
Grid No.1 to Cathode, Heater, Grid No.2, and Grid No.3	8	pF
Plate to Cathode, Heater, Grid No.2, and Grid No.3	2.5	pF

**Class A<sub>1</sub> Amplifier**

**MAXIMUM RATINGS (Design-Center Values)**

Plate Voltage .....	315	volts
Grid-No.2 (Screen-Grid) Voltage .....	285	volts
Plate Dissipation .....	12	watts
Grid-No.2 Input .....	2	watts

**CHARACTERISTICS**

Plate Voltage .....	250	volts
Grid-No.1 Voltage .....	-12.5	volts
Amplification Factor .....	9.8	
Plate Resistance (Approx.) .....	1960	ohms
Transconductance .....	5000	μmhos
Plate Current .....	49.5	mA
Grid-No.1 Voltage (Approx.) for plate current of 0.5 mA .....	-37	volts

**Vertical-Deflection Amplifier**

For operation in a 525-line, 30-frame system

**MAXIMUM RATINGS (Design-Center Values)**

	Triode Connection*	Pentode Connection	
DC Plate Voltage .....	315	315	volts
Peak Positive-Pulse Plate Voltage <sup>‡</sup> (Absolute Maximum) .....	2000 <sup>Δ</sup>	2000 <sup>Δ</sup>	volts
DC Grid-No.2 (Screen-Grid) Voltage .....	—	285	volts
Peak Negative-Pulse Grid-No.1 (Control-Grid) Voltage .....	-250	-250	volts
Peak Cathode Current .....	120	120	mA
Average Cathode Current .....	40	40	mA
Plate Dissipation .....	9	8	watts
Grid-No.2 Input .....	—	1.75	watts

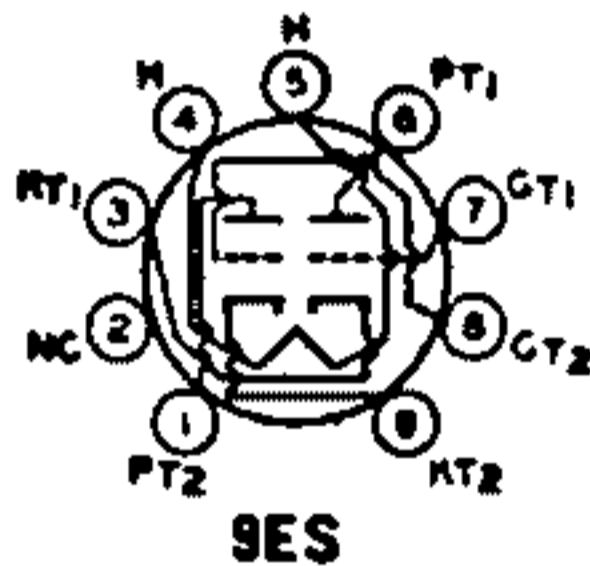
**MAXIMUM CIRCUIT VALUES**

Grid-No.1-Circuit Resistance, For cathode-bias operation .....	2.2	2.2	megohms
--	-----	-----	---------

\* Grid No.2 connected to plate.

‡ Pulse duration must not exceed 15% of a vertical scanning cycle (2.5 milliseconds).

Δ Under no circumstances should this absolute value be exceeded.



**MEDIUM-MU DUAL TRIODE**

**6CM7**  
8CM7

Miniature type used as combined vertical-deflection oscillator and vertical-deflection amplifier in black-and-white television receivers. Unit No.1 is used as a conventional blocking oscillator in vertical-deflection circuits, and unit No.2 as a vertical-deflection amplifier. Outlines section, 6E; requires miniature 9-contact socket. Types 8CM7 is identical with type 6CM7 except for heater ratings.

	6CM7	8CM7	
Heater Voltage (ac/dc) .....	6.3	8.4	volts
Heater Current .....	0.6	0.45	ampere
Heater Warm-up Time (Average) .....	11	11	seconds
Heater-Cathode Voltage:			
Peak value .....	±200 max	±200 max	volts
Average value .....	100 max	100 max	volts
Direct Interelectrode Capacitances (Approx.):	Unit No.1	Unit No.2	
Grid to Plate .....	3.8	3	pF
Grid to Cathode and Heater .....	2	3.5	pF
Plate to Cathode and Heater .....	0.5	0.4	pF

**Class A<sub>1</sub> Amplifier**

**CHARACTERISTICS**

	Unit No.1	Unit No.2	
Plate Voltage .....	200	250	volts
Grid Voltage .....	-7	-8	volts
Amplification Factor .....	21	18	
Plate Resistance (Approx.) .....	10500	4100	ohms
Transconductance .....	2000	4400	μmhos
Plate Current .....	5	20	mA
Plate Current for grid voltage of -10 volts .....	1	—	mA
Grid Voltage (Approx.) for plate current of 10 μA ..	-14	—	volts

**Vertical-Deflection Oscillator and Amplifier**

For operation in a 525-line, 30-frame system

**MAXIMUM RATINGS (Design-Maximum Values)**

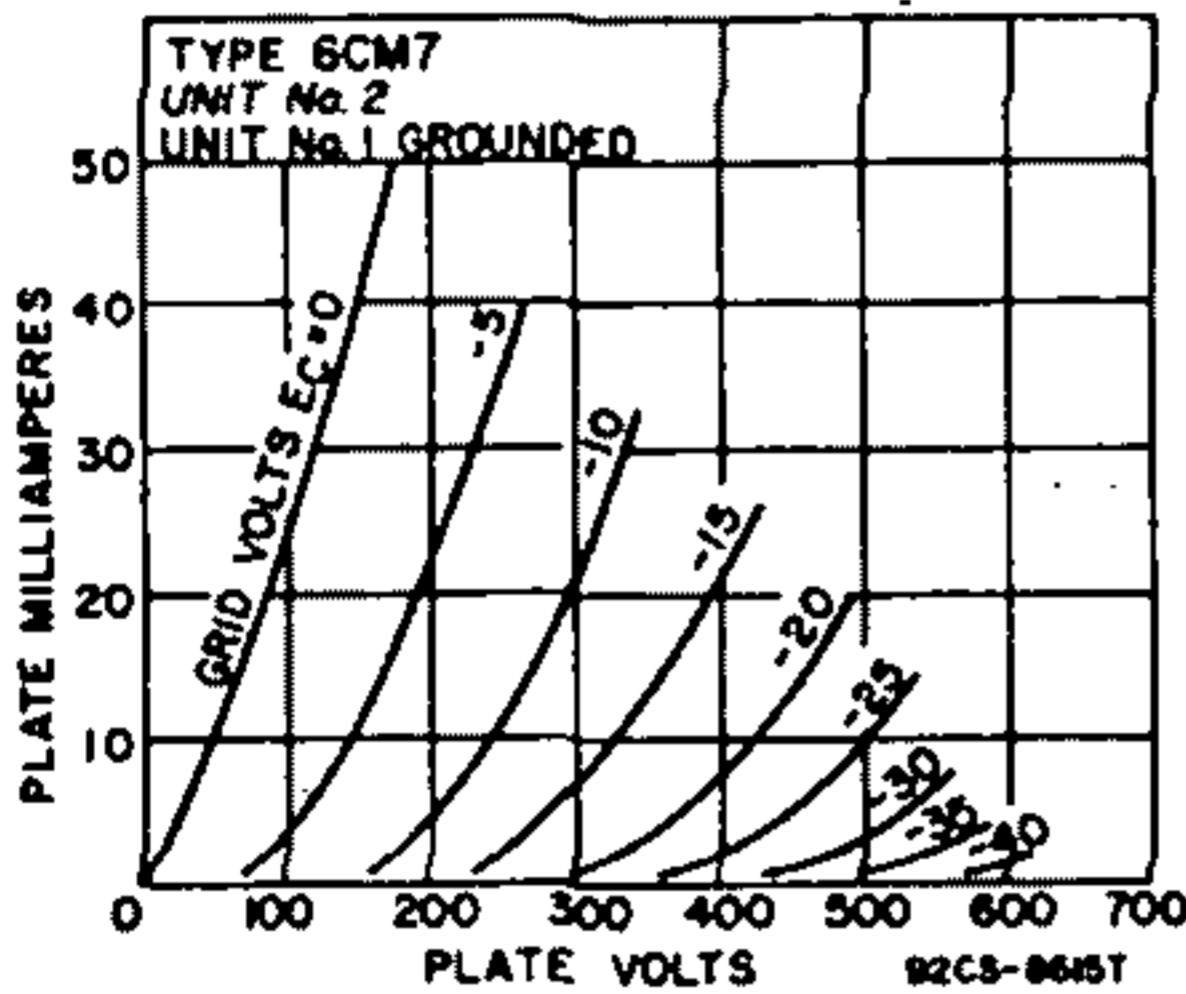
	Unit No.1 Oscillator	Unit No.2 Amplifier	
DC Plate Voltage	550	550	volts
Peak Positive-Pulse Plate Voltage*	—	2200	volts
Peak Negative-Pulse Grid Voltage	-220	-220	volts
Peak Cathode Current	77	77	mA
Average Cathode Current	17	22	mA
Plate Dissipation	1.45	6	watts

**MAXIMUM CIRCUIT VALUES**

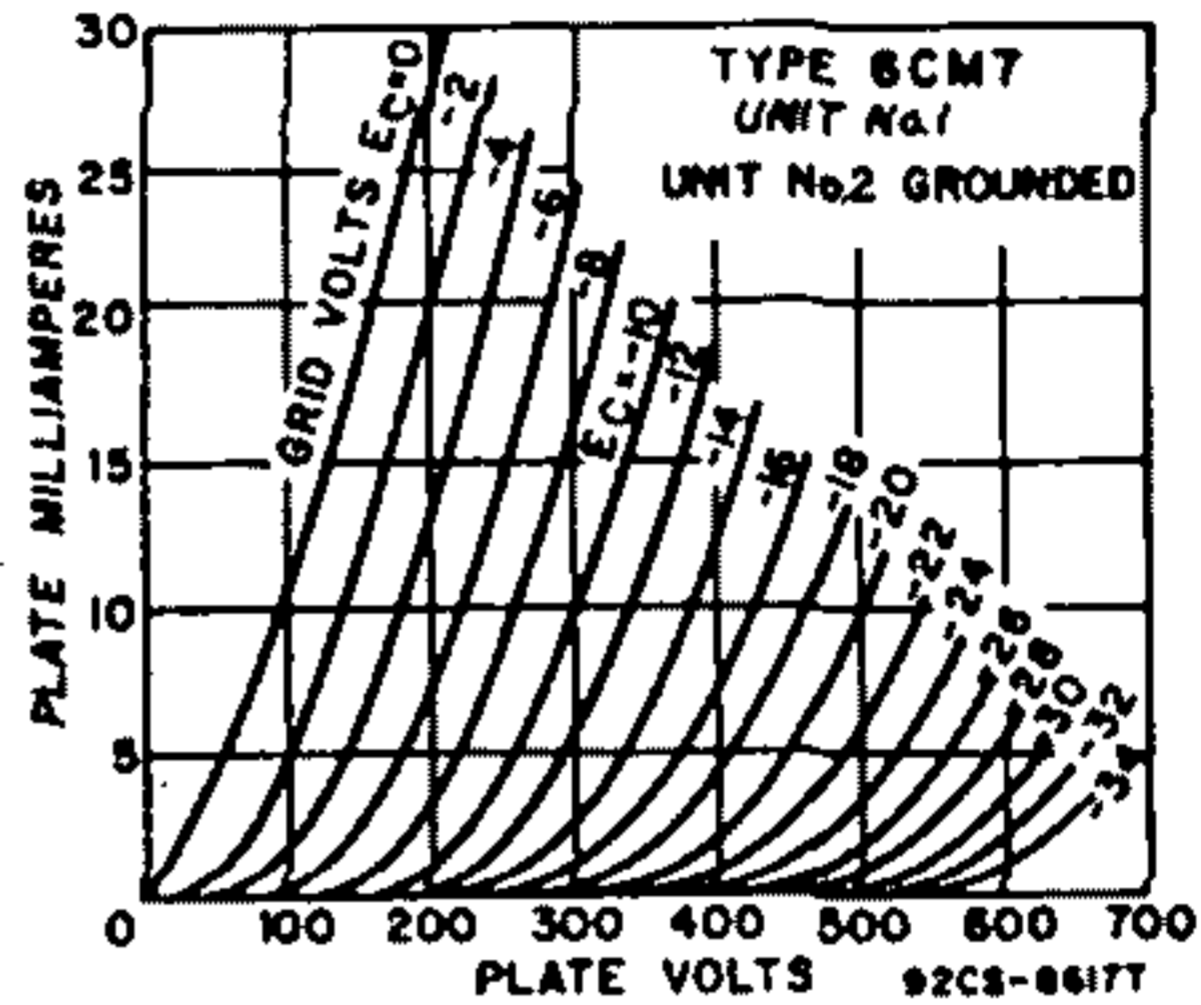
**Grid-Circuit Resistance:**

	Unit No.1	Unit No.2	
For fixed-bias operation	2.2	1.0	megohms
For cathode-bias operation	2.2	2.5	megohms
For grid-resistor-bias operation	2.2	—	megohms

\* Pulse duration must not exceed 15% of a vertical scanning cycle (2.5 milliseconds).



6CM8



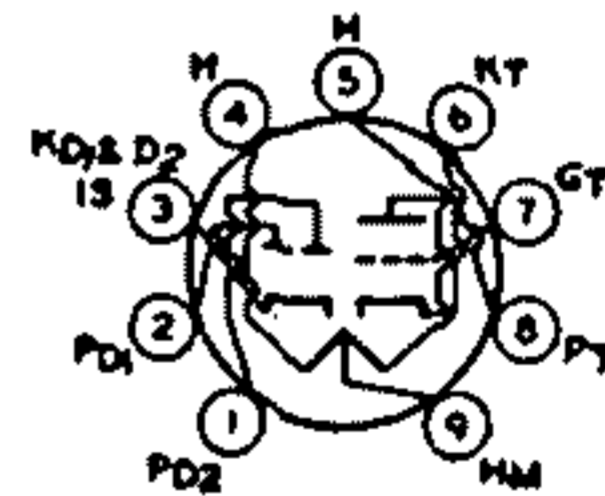
See chart at end of section.

**6CN7**

8CN7

**TWIN DIODE—  
HIGH-MU TRIODE**

Miniature type used as combined horizontal phase detector and reactance tube in color and black-and-white television receivers. The triode unit is used in sync-separator, sync-amplifier, or audio amplifier circuits. Outlines section, 6B; requires miniature 9-contact socket. For typical operation of triode unit as resistance-coupled amplifier, refer to Resistance-Coupled Amplifier section. Type 8CN7 is identical with type 6CN7 except for heater ratings.



	6CN7	8CN7	
Heater Voltage (ac/dc):			
Series	6.3	8.4	volts
Parallel	3.15	4.2	volts
Heater Current:			
Series	0.8	0.225	ampere
Parallel	0.8	0.45	ampere
Heater Warm-up Time (Average)	11	11	seconds
Heater-Cathode Voltage:			
Peak value	±200 max	±200 max	volts
Average value	100 max	100 max	volts
Direct Interelectrode Capacitances:			
Triode Unit:			
Grid to Plate		1.8	pF
Grid to Cathode and Heater		1.5	pF
Plate to Cathode and Heater		0.5	pF
Diode Units:			
Diode-No.1 Plate to Cathode of Diodes No.1 and No. 2, Heater, and Internal Shield		3.6	pF



Diode-No.2 Plate to Cathode of Diodes No.1 and No. 2, Heater, and Internal Shield .....	3.8	pF
Triode Grid to Either Diode Plate .....	0.006	pF

**Triode Unit as Class A<sub>1</sub> Amplifier**

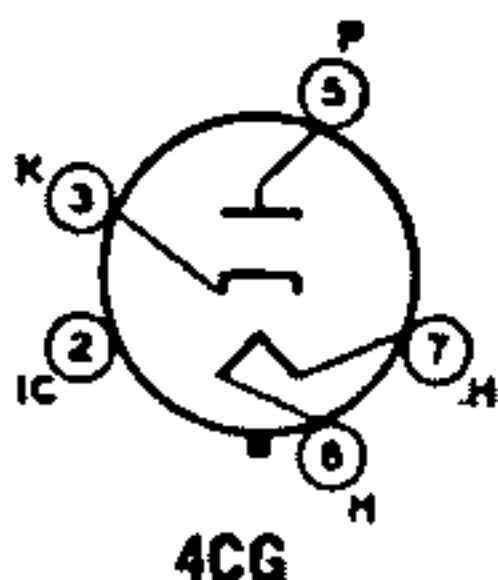
<b>MAXIMUM RATINGS (Design-Maximum Values)</b>			
Plate Voltage .....	330	volts	
Grid Voltage, Positive-bias value .....	0	volts	
Plate Dissipation .....	1.1	watt	
<b>CHARACTERISTICS</b>			
Plate Voltage .....	100	250	volts
Grid Voltage .....	-1	-3	volts
Amplification Factor .....	70	70	
Plate Resistance (Approx.) .....	54000	58000	ohms
Transconductance .....	1300	1200	μmhos
Plate Current .....	0.8	1	mA

**Diode Units**

<b>MAXIMUM RATINGS (Design-Maximum Values)</b>		
Plate Current (Each Unit) .....	5.5	mA

**HALF-WAVE  
VACUUM RECTIFIER**

**6CQ4**



Octal type used as damper tube in horizontal-deflection circuits of black-and-white television receivers. Outlines section, 13G; requires octal socket. Socket terminals 1, 2, 4, and 6 should not be used as tie points. This tube, like other power-handling tubes, should be adequately ventilated. Heater: volts (ac/dc), 6.3; amperes, 1.6.

**Damper Service**

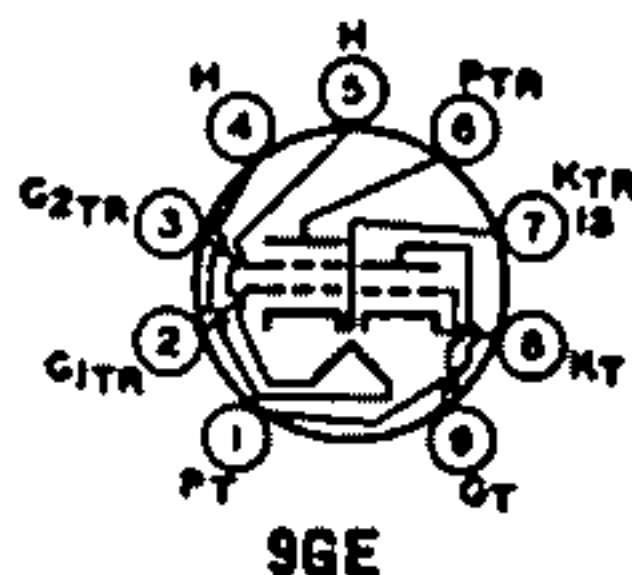
For operation in a 525-line, 30-frame system

<b>MAXIMUM RATINGS (Design-Maximum Values)</b>			
Peak Inverse Plate Current* .....	5500	volts	
Peak Plate Current .....	1200	mA	
Average Plate Current .....	190	mA	
Plate Dissipation .....	8.5	watts	
<b>Heater-Cathode Voltage:</b>			
Peak value .....	+300	-5500	volts
Average value .....	+100	-900	volts
<b>CHARACTERISTICS, Instantaneous Value</b>			
Tube Voltage Drop for plate current of 250 mA .....	25	volts	

\* Pulse duration must not exceed 15% of a horizontal scanning cycle (10 microseconds).

**MEDIUM-MU TRIODE—  
SHARP-CUTOFF TETRODE**

**6CQ8  
5CQ8**



Miniature type used in color and black-and-white television receiver applications. The tetrode unit is used as a mixer, video if amplifier, or sound if amplifier tube. The triode unit is used in vhf oscillator, phase-splitter, sync-clipper, sync-separator, and rf amplifier circuits. Outlines section, 6B; requires miniature 9-contact socket. Type 5CQ8 is identical with type 6CQ8 except for heater ratings.

Heater Voltage (ac/dc) .....	5CQ8 4.7	6CQ8 6.3	volts
Heater Current .....	0.6	0.45	ampere
Heater Warm-up Time (Average) .....	11	11	seconds
<b>Heater-Cathode Voltage:</b>			
Peak value .....	±200 max	±200 max	volts
Average value .....	100 max	100 max	volts
<b>Direct Interelectrode Capacitances:</b>			
<b>Triode Unit:</b>			
Grid to Plate .....	1.8	1.8	pF
Grid to Cathode and Heater .....	2.7	2.7	pF
Plate to Cathode and Heater .....	0.4	1.2	pF

<b>Tetrode Unit:</b>			
Grid No.1 to Plate .....	0.019 max	0.015 max	pF
Grid No.1 to Cathode, Heater, Grid No.2 and Internal Shield .....	5.0	5.0	pF
Plate to Cathode, Heater, Grid No.2, and Internal Shield .....	2.5	3.3	pF
Tetrode Plate to Triode Plate .....	0.07 max	0.01 max	pF
Heater to Cathode (Each Unit) .....	3.0	3.0†	pF

\* With external shield connected to cathode of unit under test.  
† With external shield connected to ground.

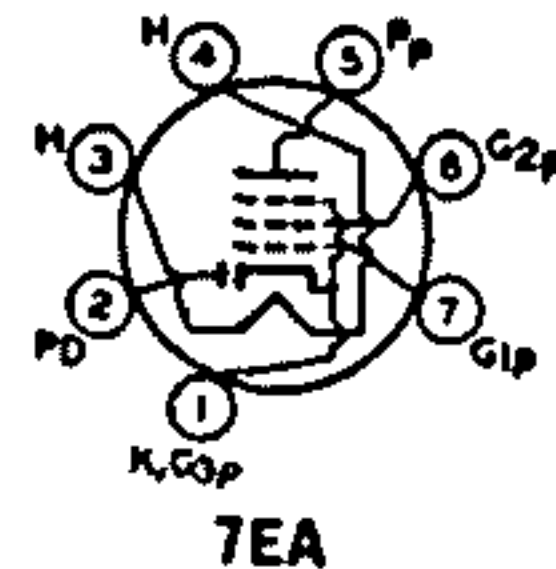
**Class A<sub>1</sub> Amplifier**

<b>MAXIMUM RATINGS (Design-Maximum Values)</b>			
Plate Voltage .....	330	330	volts
Grid-No.2 (Screen-Grid) Supply Voltage .....	—	330	volts
Grid-No.2 Voltage .....	—	See curve page 96	
Grid-No.1 (Control-Grid) Voltage, Positive-bias value .....	0	0	volts
Plate Dissipation .....	3.1	3.2	watts
Grid-No.2 Input:			
For grid-No.2 voltages up to 165 volts .....	—	0.7	watt
For grid-No.2 voltages between 165 and 330 volts .....	—	See curve page 96	
Grid Input .....	0.55	—	watt
<b>CHARACTERISTICS</b>			
Plate-Supply Voltage .....	125	125	volts
Grid-No.2 Supply Voltage .....	—	125	volts
Grid-No.1 Voltage .....	—	—1	volts
Cathode-Bias Resistor .....	58	—	ohms
Amplification Factor .....	40	—	
Plate Resistance (Approx.) .....	5000	140000	ohms
Transconductance .....	8000	5800	μmhos
Plate Current .....	15	12	mA
Grid-No.2 Current .....	—	4.2	mA
Grid-No.1 Voltage (Approx.) for plate current of 100 μA .....	—7	—7	volts
<b>MAXIMUM CIRCUIT VALUES</b>			
Grid-No.1-Circuit Resistance:			
For fixed-bias operation .....	0.6	0.25	megohm
For cathode-bias operation .....	1.0	1.0	megohm

**6CR6**  
12CR6

**DIODE—  
REMOTE-CUTOFF PENTODE**

Miniature type used as combined detector and audio amplifier in automobile and ac-operated radio receivers. The diode unit is used as an AM detector, and the pentode unit as an automatic-volume-controlled audio amplifier. Outlines section, 5C; requires miniature 7-contact socket. Type 12CR6 is identical with type 6CR6 except for heater ratings.



Heater Voltage (ac/dc) .....	6CR6	12CR6	
Heater Current .....	6.3	12.5	volts
Peak Heater-Cathode Voltage .....	0.8	0.15	amperes
	±100 max	±100 max	volts

**Pentode Unit as Class A<sub>1</sub> Amplifier**

<b>MAXIMUM RATINGS (Design-Center Values)</b>			
Plate Voltage .....		300	volts
Grid-No.2 (Screen-Grid) Voltage .....		See curve page 96	
Grid-No.2 Supply Voltage .....		300	volts
Grid-No.1 (Control-Grid) Voltage, Positive-bias value .....		0	volts
Plate Dissipation .....		2.5	watts
Grid-No.2 Input:			
For grid-No.2 voltages up to 150 volts .....		0.3	watt
For grid-No.2 voltages between 150 and 300 volts .....		See curve page 96	
<b>CHARACTERISTICS</b>			
Plate Voltage .....		250	volts
Grid-No.2 Voltage .....		100	volts
Grid-No.1 Voltage .....		—2	volts
Plate Resistance (Approx.) .....		0.8	megohm
Transconductance .....		2200	μmhos
Plate Current .....		9.6	mA
Grid-No.2 Current .....		2.6	mA
Grid-No.1 Voltage (Approx.) for transconductance of 10 μmhos .....		—33	volts

**MAXIMUM CIRCUIT VALUES**

Grid-No.1-Circuit Resistance:

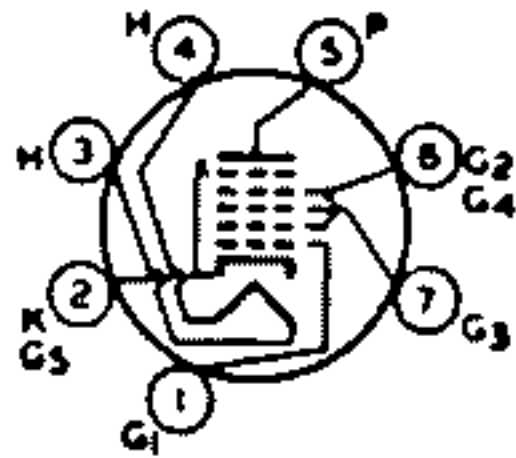
For fixed-bias operation .....	0.25	megohm
For cathode-bias operation .....	1.0	megohm

**Diode Unit**

**MAXIMUM RATINGS (Design-Center Values)**

Plate Current .....	1	mA
---------------------	---	----

**6CS6**  
3CS6, 4CS6



7CH

**PENTAGRID AMPLIFIER**

Miniature type used as a gated amplifier in color and black-and-white television receivers. In such service, it may be used as a combined sync separator and sync clipper. Outlines section, 5C; requires miniature 7-contact socket. Types 3CS6 and 4CS6 are identical with type 6CS6 except for heater ratings.

	3CS6	4CS6	6CS6	
Heater Voltage (ac/dc) .....	3.15	4.2	6.3	volts
Heater Current .....	0.6	0.45	0.3	ampere
Heater Warm-up Time (Average) .....	11	11	11	seconds
Heater-Cathode Voltage:				
Peak value .....	±200 max	±200 max	±200 max	volts
Average Value .....	100 max	100 max	100 max	volts
Direct Interelectrode Capacitances (Approx.)				
Grid No.1 to Plate .....			0.07 max	pF
Grid No.3 to Plate .....			0.36 max	pF
Grid No.1 to Grid No.3 .....			0.22 max	pF
Grid No.1 to Cathode, Heater, Grid No.2, Grid No.3, Grid No.4, and Grid No.5 .....			5.5	pF
Grid No.3 to Cathode, Heater, Grid No.1, Grid No.2, Grid No.4, and Grid No.5 .....			7	pF
Plate to Cathode, Heater, Grid No.1, Grid No.2, Grid No.3, Grid No.4, and Grid No.5 .....			7.5	pF

**Class A<sub>1</sub> Amplifier**

**CHARACTERISTICS**

Plate Voltage .....	100	100	volts
Grids-No.2-and-No.4 Voltage .....	30	30	volts
Grid-No.3 Voltage .....	-1	0	volt
Grid-No.1 Voltage .....	0	-1	volt
Plate Resistance (Approx.) .....	0.7	1	megohm
Grid-No.3-to-Plate Transconductance .....	1500	—	μmhos
Grid-No.1-to-Plate Transconductance .....	—	1100	μmhos
Plate Current .....	0.8	1.0	mA
Grids-No.2-and-No.4 Current .....	5.6	1.3	mA
Grid-No.3 Voltage (Approx.) for plate current of 50 μA .....	-2.2	—	volts
Grid-No.1 Voltage (Approx.) for plate current of 50 μA .....	—	-2.5	volts

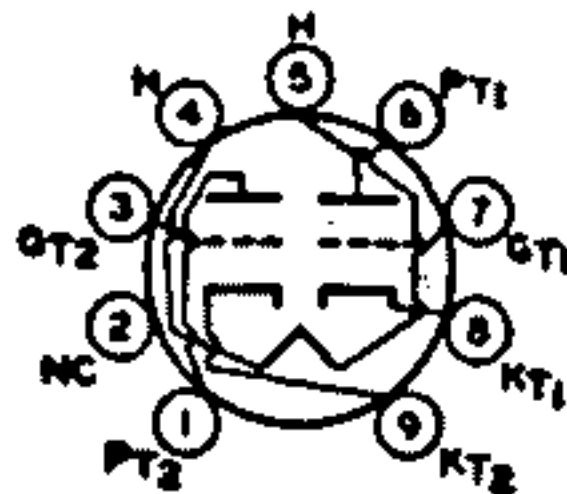
**Gated Amplifier Service**

**MAXIMUM RATINGS (Design-Center Values)**

Plate Voltage .....	300	volts
Grids-No.2-and-No.4 Supply Voltage .....	300	volts
Grids-No.2-and-No.4 Voltage .....	See curve page 96	
Cathode Current .....	14	mA
Plate Dissipation .....	1	watt
Grids-No.2-and-No.4 Input:		
For grids-No.2-and-No.4 voltages up to 150 volts .....	1	watt
For grids-No.2-and-No.4 voltages between 150 and 300 volts .....	See curve page 96	

**MAXIMUM CIRCUIT VALUES**

Grid-No.1-Circuit Resistance .....	0.47	megohm
Grid-No.3-Circuit Resistance .....	2.2	megohms



9EF

**MEDIUM-MU DUAL TRIODE**

Miniature type used as combined vertical-deflection oscillator and vertical-deflection amplifier in television receivers. Unit No.1 is used as a conventional blocking oscillator in vertical-deflection circuits, and unit

**6CS7**  
8CS7



No.2 as a vertical-deflection amplifier. Outlines section, 6E; require miniature 9-contact socket. Type 8CS7 is identical with type 6CS7 except for heater ratings.

	6CS7	8CS7	
Heater Voltage (ac/dc)	6.3	8.4	volts
Heater Current	0.6	0.45	ampere
Heater Warm-up Time (Average)	11	11	seconds
Heater-Cathode Voltage:			
Peak value	±200 max	±200 max	volts
Average value	100 max	100 max	volts
Direct Interelectrode Capacitances (Approx.):	Unit No.1	Unit No.2	
Grid to Plate	2.6	2.6	pF
Grid to Cathode and Heater	1.8	3	pF
Plate to Cathode and Heater	0.5	0.5	pF

**Class A<sub>1</sub> Amplifier**

CHARACTERISTICS	Unit No.1 Oscillator	Unit No.2 Amplifier	
Plate Voltage	250	250	volts
Grid Voltage	-8.5	-10.5	volts
Amplification Factor	17	15.5	
Plate Resistance (Approx.)	7700	8450	ohms
Transconductance	2200	4500	μmhos
Plate Current	10.5	19	mA
Plate Current for grid voltage of -16 volts	—	3	mA
Grid Voltage (Approx.) for plate current of 10 μA	-24	—	volts
Grid Voltage (Approx.) for plate current of 50 μA	—	-22	volts

**Vertical-Deflection Oscillator and Amplifier**

For operation in a 525-line, 30-frame system

	Unit No.1 Oscillator	Unit No.2 Amplifier	
<b>MAXIMUM RATINGS (Design-Center Values)</b>			
DC Plate Voltage	500	500	volts
Peak Positive-Pulse Plate Voltage* (Absolute Maximum)	—	2200 <sup>Δ</sup>	volts
Peak Negative-Pulse Grid Voltage	-400	-250	volts
Peak Cathode Current	70	105	mA
Average Cathode Current	20	30	mA
Plate Dissipation	1.25	6.5	watts
<b>MAXIMUM CIRCUIT VALUES</b>			
Grid-Circuit Resistance	2.2	2.2	megohms

\* Pulse duration must not exceed 15% of a vertical scanning cycle (2.5 milliseconds).

<sup>Δ</sup> Under no circumstances should this absolute value be exceeded.

**6CU5**

12CU5/12C5, 17CU5

**BEAM POWER TUBE**

Miniature type used in the audio output stage of television receivers. Outlines section, 5D; requires miniature 7-contact socket. Types 12CU5/12C5 and 17CU5 are identical with type 6CU5 except for heater ratings.



7CV

	6CU5	12CU5/12C5	17CU5	
Heater Voltage (ac/dc)	6.3	12.6	16.8	volts
Heater Current	1.2	0.6	0.45	ampere
Heater Warm-up Time (Average)	—	11	11	seconds
Heater-Cathode Voltage:				
Peak value	±200 max	±200 max	±200 max	volts
Average value	100 max	100 max	100 max	volts
Direct Interelectrode Capacitances (Approx.):				
Grid No.1 to Plate			0.6	pF
Grid No.1 to Cathode, Heater, Grid No.2, and Grid No.3			13	pF
Plate to Cathode, Heater, Grid No.2, and Grid No.3			8.5	pF

**Class A<sub>1</sub> Amplifier**

MAXIMUM RATINGS (Design-Maximum Values)		
Plate Voltage	150	volts
Grid-No.2 (Screen-Grid) Voltage	130	volts
Grid-No.1 (Control-Grid) Voltage, Positive-bias value	0	volts
Plate Dissipation	7	watts
Grid-No.2 Input	1.4	watts
Bulb Temperature (At hottest point)	220	°C

**TYPICAL OPERATION**

Plate Voltage	120	volts
Grid-No.2 Voltage	110	volts
Grid-No.1 Voltage	-8	volts
Peak AF Grid-No.1 Voltage	8	volts
Zero-Signal Plate Current	49	mA
Maximum-Signal Plate Current	60	mA
Zero-Signal Grid-No.2 Current	4	mA
Maximum-Signal Grid-No.2 Current	8.5	mA
Plate Resistance (Approx.)	10000	ohms
Transconductance	7500	μmhos
Load Resistance	2500	ohms
Total Harmonic Distortion	10	per cent
Maximum-Signal Power Output	2.3	watts

**MAXIMUM CIRCUIT VALUES**

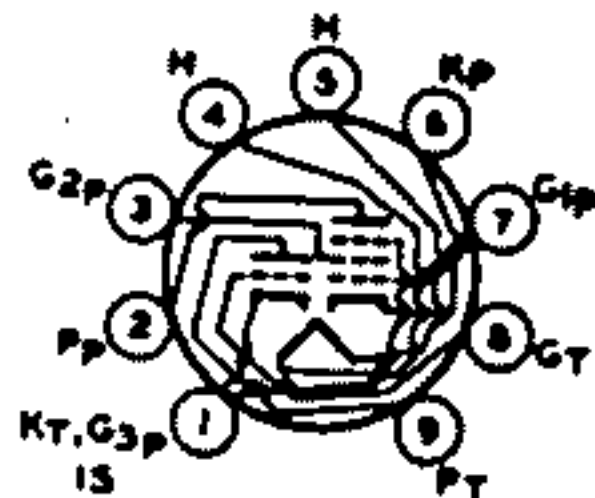
Grid-No.1-Circuit Resistance:		
For fixed-bias operation	0.1	megohm
For cathode-bias operation	0.5	megohm

Refer to type 6BQ6GTB/6CU6.

**6CU6**

**MEDIUM-MU TRIODE—  
SHARP-CUTOFF PENTODE**

**6CU8**



**9GM**

Miniature type used in color and black-and-white television receiver applications. The pentode unit is used as an if amplifier, video amplifier, agc amplifier, and reactance tube. The triode unit is used in low-frequency oscillator, sync-separator, sync-clipper, and phase-splitter circuits. Outlines section, 6B; requires miniature 9-contact socket.

Heater Voltage (ac/dc)	6.3	volts
Heater Current	0.45	ampere
Heater-Cathode Voltage:		
Peak value	±200 max	volts
Average value	100 max	volts
Direct Interelectrode Capacitances:		
Triode Unit:		
Grid to Plate	1.6	pF
Grid to Cathode, Heater, Pentode Grid No.3, and Internal Shield	1.9	pF
Plate to Cathode, Heater, Pentode Grid No.3 and Internal Shield	1.6	pF
Pentode Unit:		
Grid No.1 to Plate	0.025 max	pF
Grid No.1 to Cathode, Heater, Grid No.2, Grid No.3, Triode Cathode, and Internal Shield	7	pF
Plate to Cathode, Heater, Grid No.2, Grid No.3, Triode Cathode, and Internal Shield	2.4	pF
Pentode Grid No.1 to Triode Plate	0.03 max	pF
Pentode Plate to Triode Plate	0.07 max	pF

**Class A<sub>1</sub> Amplifier**

MAXIMUM RATINGS (Design-Maximum Values)	Triode Unit	Pentode Unit	
Plate Voltage	330	330	volts
Grid-No.2 Supply Voltage	—	330	volts
Grid-No.2 (Screen-Grid) Voltage	—	See curve page 96	
Grid-No.1 (Control-Grid) Voltage, Positive-bias value	0	0	volts
Plate Dissipation	2.8	2.3	watts
Grid-No.2 Input:			
For grid-No.2 voltages up to 165 volts	—	0.55	watt
For grid-No.2 voltages between 165 and 330 volts	—	See curve page 96	
<b>CHARACTERISTICS</b>			
Plate Supply Voltage	125	125	volts
Grid-No.2 Supply Voltage	—	125	volts
Grid-No.1 Voltage	-1	—	volts
Cathode-Bias Resistor	—	56	ohms
Amplification Factor	24	—	
Plate Resistance (Approx.)	4100	170000	ohms
Transconductance	5800	7800	μmhos
Plate Current	17	12	mA
Plate Current for grid-No.1 voltage of -3 volts	—	-1.6	mA
Grid-No.2 Current	—	3.8	mA
Grid-No.1 Voltage (Approx.) for plate current of 20 μA	-19	-8	volts

# 6CW4

2CW4, 13CW4

## HIGH-MU TRIODE

Nuvistor type used as a grounded-cathode, neutralized rf amplifier in vhf tuners of color and black-and-white television and FM receivers. Outlines section, 1; requires nuvistor socket. Types 2CW4 and 13CW4 are identical with type 6CW4 except for heater ratings.



	2CW4	6CW4	13CW4	
Heater Voltage (ac/dc)	2.1	6.3	13.5	volts
Heater Current	0.45	0.135	0.06	ampere
Heater Warm-up Time (Average)	8	—	—	seconds
Peak Heater-Cathode Voltage	±100 max	±100 max	±100 max	volts
<b>Direct Interelectrode Capacitances (Approx.)</b>				
Grid to Plate			0.92	pF
Grid to Cathode, Heater, and Shell			4.3	pF
Plate to Cathode, Heater, and Shell			1.8	pF
Plate to Cathode			0.18	pF
Heater to Cathode			1.6	pF

### Class A<sub>1</sub> Amplifier

#### MAXIMUM RATINGS (Design-Maximum Values)

Plate Supply Voltage	300*	volts
Plate Voltage	185	volts
Grid Voltage:		
Negative-bias value	55	volts
Peak positive value	0	volts
Cathode Current	15	mA
Plate Dissipation	1.5	watt

#### CHARACTERISTICS AND TYPICAL OPERATION

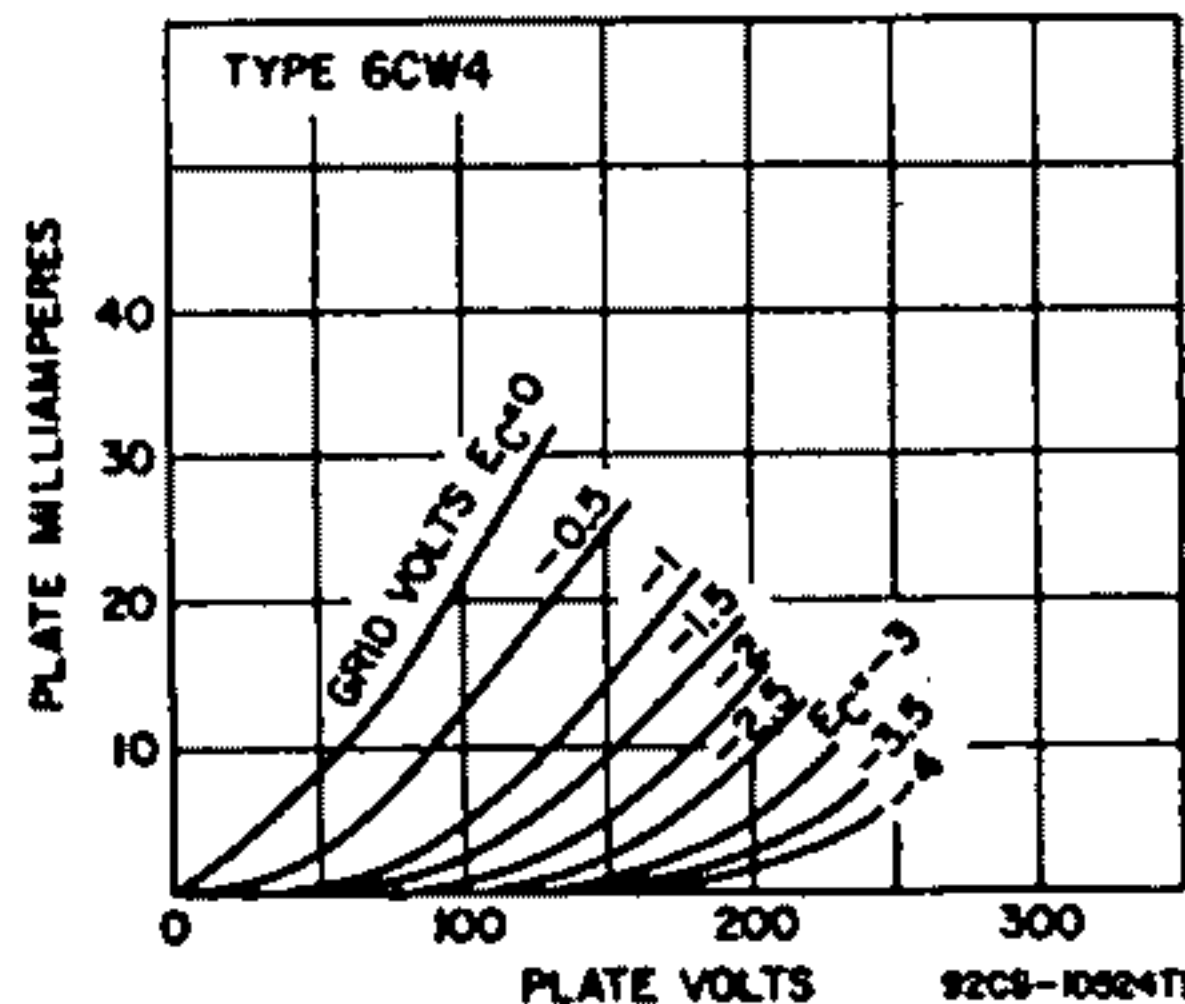
	Characteristics	Typical Operation	
Plate Supply Voltage	110	70	volts
Grid Supply Voltage	0	0	volts
Cathode-Bias Resistor	180	—	ohms
Grid Resistor	—	47000	ohms
Amplification Factor	65	68	
Plate Resistance (Approx.)	6600	5440	ohms
Transconductance	9800	12500	μmhos
Plate Current	7	7.2	mA
Grid Voltage (Approx.) for plate current of 10 μA	-4	—	volts

#### MAXIMUM CIRCUIT VALUES

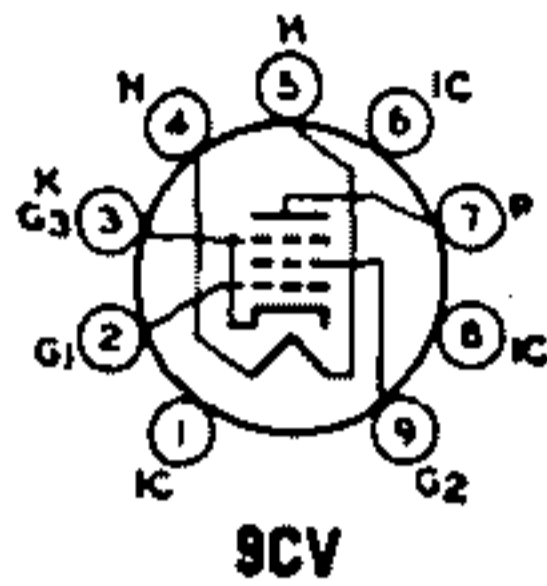
<b>Grid-Circuit Resistance:</b>		
For fixed-bias operation	0.5	megohm
For cathode-bias operation	2.2	megohms

\* A plate supply voltage of 300 volts may be used provided a sufficiently large resistor is used in the plate circuit to limit the plate dissipation to 1.5 watts under any condition of operation.

• For operation at metal-shell temperatures up to 185° C.







**POWER PENTODE**

**6CW5  
6CW5/  
EL86**

8CW5, 10CW5,  
15CW5, 15CW5/PL84

Miniature types with frame grid used for vertical-deflection amplifier service in color and black-and-white television receivers. Outlines section, 6G; require miniature 9-contact socket. Types 8CW5, 10CW5, 15CW5, and 15CW5/PL84 are identical with types 6CW5 and 6CW5/EL86 except for heater ratings.

	6CW5 6CW5/EL86	8CW5	10CW5	15CW5 15CW5/PL84	
Heater Voltage (ac/dc) .....	6.3	8	10.6	15	volts
Heater Current .....	0.76	0.6	0.45	0.3	ampere
Heater Warm-up Time .....	—	—	11	—	seconds
Heater-Cathode Voltage:					
Peak value .....	±330 max	±330 max	±330 max	±330 max	volts
Average value .....	±220 max	±220 max	±220 max	±220 max	volts
Direct Interelectrode Capacitances:					
Grid No.1 to Plate .....				0.6	pF
Grid No.1 to Heater .....				0.25 max	pF
Grid No.1 to Cathode, Heater, Grid No.2, and Grid No.3 .....				13	pF
Plate to Cathode, Heater, Grid No.2, and Grid No.3 .....				6.8	pF

**Class A<sub>1</sub> or Class AB<sub>1</sub> Amplifier**

MAXIMUM RATINGS (Design-Maximum Values)		
Plate Voltage .....	275	volts
Plate Supply Voltage .....	600	volts
Grid-No.2 Voltage .....	220	volts
Grid-No.2 (Screen-Grid) Supply Voltage .....	600	volts
Cathode Current .....	110	mA
Plate Dissipation .....	14	watts
Grid-No.2 Input .....	2.1	watts
Peak Grid-No.2 Input .....	7	watts
CHARACTERISTICS		
Plate Voltage .....	170	volts
Grid-No.2 Voltage .....	170	volts
Grid-No.1 (Control-Grid) Voltage .....	-12.5	volts
Mu Factor (Grid No.2 to Grid No.1) .....	8	
Plate Resistance .....	26000	ohms
Transconductance .....	11000	μmhos
Plate Current .....	70	mA
Grid-No.2 Current .....	2.5	mA
MAXIMUM CIRCUIT VALUE		
Grid-No.1-Circuit Resistance .....	1	megohm

**Vertical-Deflection Amplifier**

For operation in a 525-line, 30-frame system

MAXIMUM RATINGS (Design-Maximum Values)		
Plate Voltage .....	275	volts
Peak Positive-Pulse Plate Voltage# .....	2200	volts
Grid-No.2 Voltage .....	275	volts
Peak Negative-Pulse Grid-No.1 Voltage .....	-250	volts
Peak Cathode Current .....	240	mA
Average Cathode Current .....	110	mA
Plate Dissipation .....	12	watts
Grid-No.2 Input .....	2.1	watts
MAXIMUM CIRCUIT VALUE		
Grid-No.1-Circuit Resistance .....	2.2	megohms

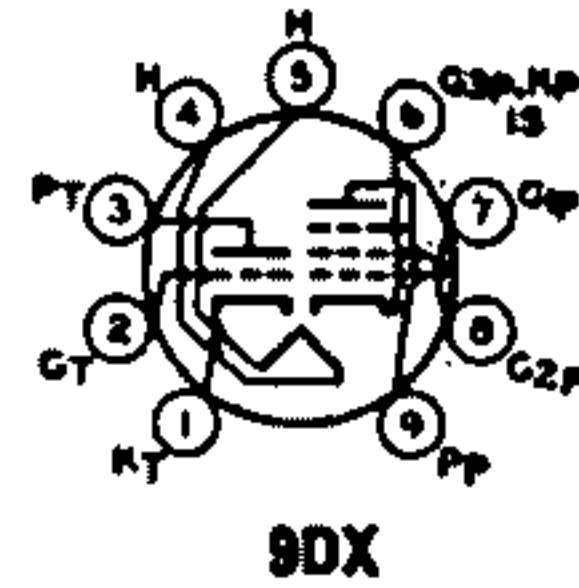
# Pulse duration must not exceed 6% of a vertical scanning cycle (1.2 milliseconds).

# 6CX8

8CX8

## MEDIUM-MU TRIODE— SHARP-CUTOFF PENTODE

Miniature type used in television receiver applications. Pentode unit is used as video amplifier; triode unit is used in sound if-amplifier, sweep-oscillator, sync-separator, sync-amplifier, and sync-clipper circuits. Outlines section, 6E; requires miniature 9-contact socket. Type 8CX8 is identical with type 6CX8 except for heater ratings.



	6CX8	8CX8	
Heater Voltage (ac/dc)	6.3	8	volts
Heater Current	0.75	0.6	ampere
Heater Warm-up Time (Average)	—	11	volts
Heater-Cathode Voltage:			
Peak value	±200 max	±200 max	volts
Average value	100 max	100 max	volts
Direct Interelectrode Capacitances:			
Triode Unit:			
Grid to Plate		4.4	pF
Grid to Cathode and Heater		2.2	pF
Plate to Cathode and Heater		0.38	pF
Pentode Unit:			
Grid No.1 to Plate		0.06	pF
Grid No.1 to Cathode, Heater, Grid No.2, Grid No.3, and Internal Shield		0	pF
Plate to Cathode, Heater, Grid No.2, Grid No.3, and Internal Shield		4.4	pF
Triode Grid to Pentode Plate		0.018 max	pF
Pentode Grid No.1 to Triode Plate		0.006 max	pF
Pentode Plate to Triode Plate		0.17 max	pF

### Class A<sub>1</sub> Amplifier

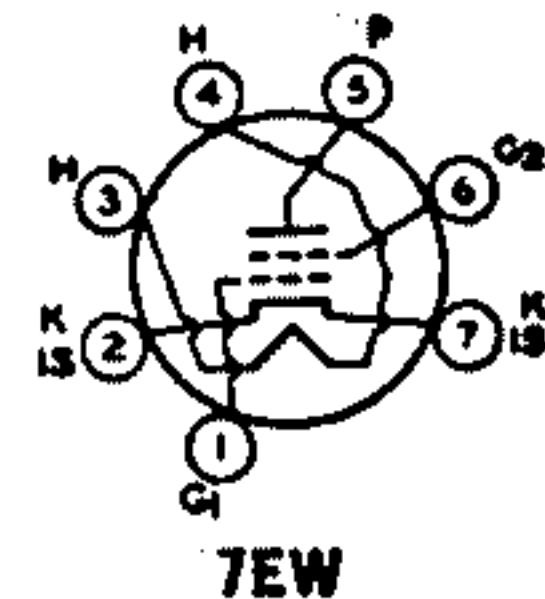
	Triode Unit	Pentode Unit	
<b>MAXIMUM RATINGS (Design-Maximum Values)</b>			
Plate Voltage	330	330	volts
Grid-No.2 (Screen-Grid) Voltage	—	330	volts
Grid-No.2 Voltage	—	See curve page 96	
Grid-No.1 (Control-Grid) Voltage, Positive-bias value	0	0	volts
Plate Dissipation	2	5	watts
Grid-No.2 Input:			
For grid-No.2 voltages up to 165 volts	—	1.1	watts
For grid-No.2 voltages between 165 and 330 volts	—	See curve page 96	
<b>CHARACTERISTICS</b>			
Plate Supply Voltage	150	200	volts
Grid-No.2 Supply Voltage	—	125	volts
Cathode-Bias Resistor	150	68	ohms
Amplification Factor	40	—	
Plate Resistance (Approx.)	8700	70000	ohms
Transconductance	4500	10000	μmhos
Plate Current	9.2	24	mA
Grid-No.2 Current	—	52	mA
Grid-No.1 (Voltage Approx.) for plate current of 100 μA	-5	-8.5	volts
<b>MAXIMUM CIRCUIT VALUES</b>			
Grid-No.1-Circuit Resistance:			
For fixed-bias operation	0.5	0.25	megohm
For cathode-bias operation	1	1	megohm

# 6CY5

2CY5, 3CY5, 4CY5

## SHARP-CUTOFF TETRODE

Miniature type used as rf amplifier in vhf tuners of television receivers. Outlines section, 5C; requires miniature 7-contact socket. Types 2CY5, 3CY5, and 4CY5 are identical with type 6CY5 except for heater ratings.



	2CY5	3CY5	4CY5	6CY5	
Heater Voltage (ac/dc)	2.4	2.9	4.5	6.3	volts
Heater Current	0.6	0.45	0.3	0.2	ampere
Heater Warm-up Time (Average)	11	11	11	—	seconds
Peak Heater-Cathode Voltage	±100 max	±100 max	±100 max	±100 max	volts

Direct Interelectrode Capacitances (Approx.):

Grid-No.1 to Plate .....	0.08	pF
Grid-No.1 to Cathode, Heater, Grid No.2 and Internal Shield ..	4.5	pF
Plate to Cathode, Heater, Grid No.2, and Internal Shield ..	3	pF

\* With external shield connected to cathode.

**Class A<sub>1</sub> Amplifier**

**MAXIMUM RATINGS (Design-Maximum Values)**

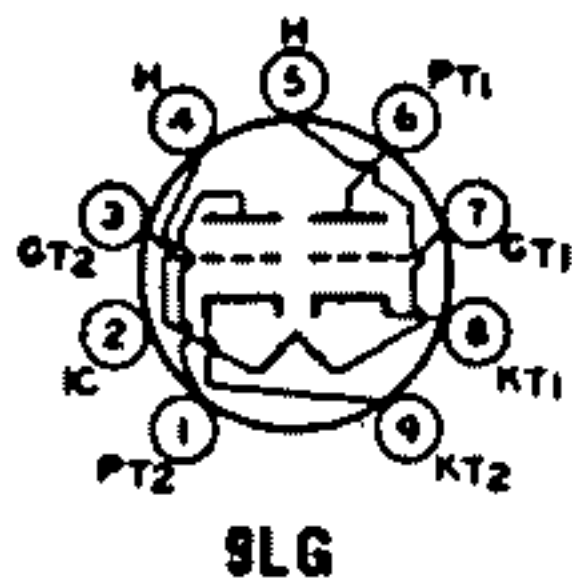
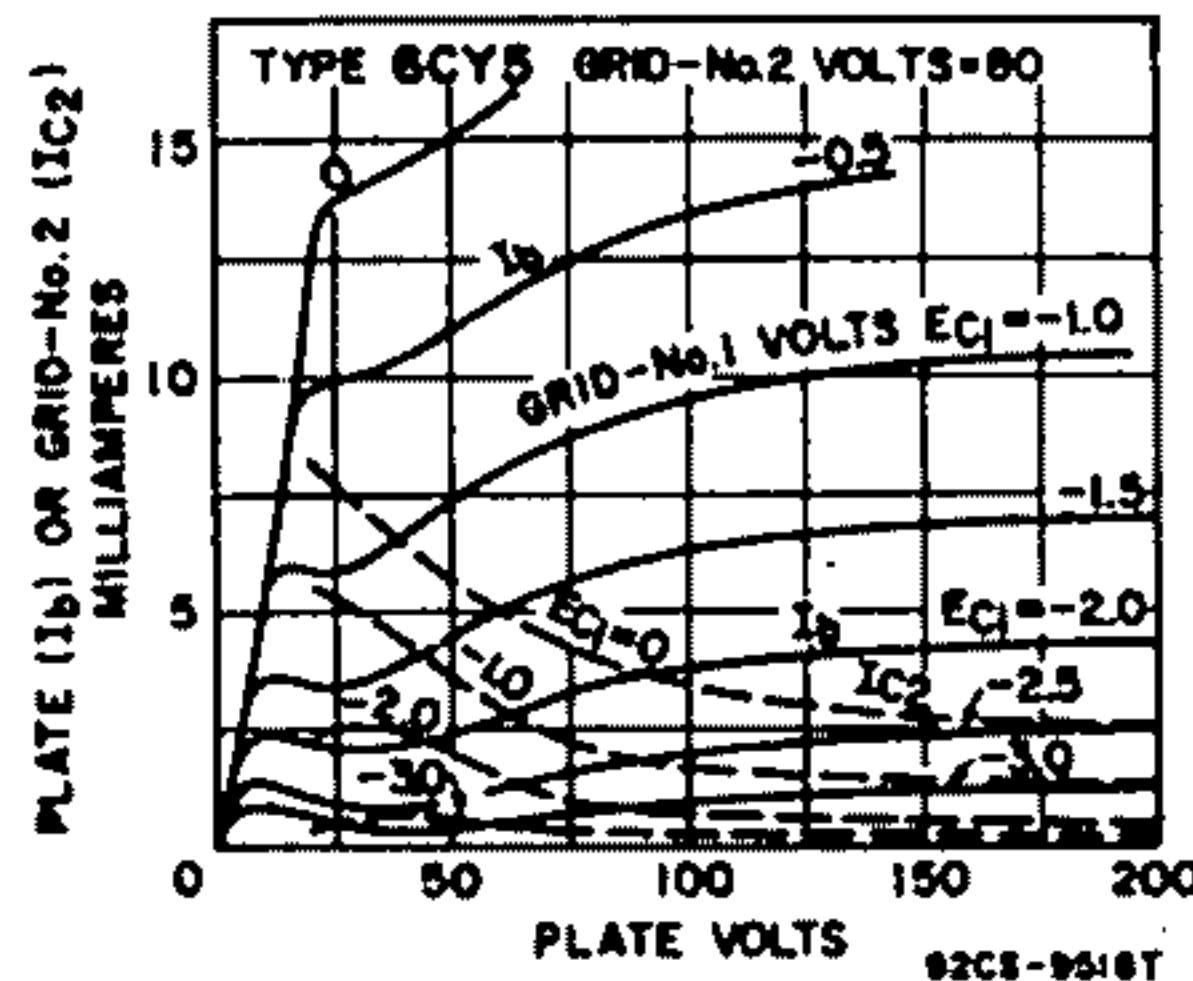
Plate Voltage .....	180	volts
Grid-No.2 (Screen-Grid) Supply Voltage .....	180	volts
Grid-No.2 Voltage .....	See curve page 96	
Grid-No.1 (Control-Grid) Voltage, Positive-bias value .....	0	volts
Cathode Current .....	20	mA
Plate Dissipation .....	2	watts
Grid-No.2 Input:		
For grid-No.2 voltages up to 90 volts .....	0.5	watt
For grid-No.2 voltages between 90 and 180 volts .....	See curve page 96	

**CHARACTERISTICS**

Plate Voltage .....	125	volts
Grid-No.2 Voltage .....	80	volts
Grid-No.1 Voltage .....	-1	volt
Plate Resistance (Approx.) .....	0.1	megohm
Transconductance .....	8000	$\mu$ mhos
Plate Current .....	10	mA
Grid-No.2 Current .....	1.5	mA
Grid-No.1 Voltage (Approx.) for plate current of 20 $\mu$ A .....	-6	volts

**MAXIMUM CIRCUIT VALUE**

Grid-No.1-Circuit Resistance .....	0.5	megohm
------------------------------------	-----	--------



**DUAL TRIODE**

Miniature type used as combined vertical oscillator and vertical-deflection amplifier in television receivers. Unit No.1 is used as a blocking oscillator in vertical-deflection circuits, and unit No.2 is used as a vertical-deflection amplifier. Outlines section, 6E; requires miniature 9-contact socket. Type 11CY7 is identical with type 6CY7 except for heater ratings.

**6CY7**  
11CY7

Heater Voltage (ac/dc) .....	6.3	11	volts
Heater Current .....	0.75	0.45	ampere
Heater Warm-up Time (Average) .....	—	11	seconds
Heater-Cathode Voltage:			
Peak value .....	±200 max	±200 max	volts
Average value .....	100 max	100 max	volts

**Class A<sub>1</sub> Amplifier**

<b>CHARACTERISTICS</b>	Unit No.1	Unit No.2	
Plate Supply Voltage .....	250	150	volts
Grid Voltage .....	-3	—	volts



Cathode-Bias Resistor .....	—	620	ohms
Amplification Factor .....	68	5	
Plate Resistance (Approx.) .....	52000	920	ohms
Transconductance .....	1300	5400	μmhos
Plate Current .....	1.2	30	mA
Plate Current for grid voltage of —30 volts .....	—	2.5	mA
Grid Voltage (Approx.) for plate current of 10 μA ..	—5.5	—	volts
Grid Voltage (Approx.) for plate current of 200 μA ..	—	—40	volts

**Vertical-Deflection Oscillator and Amplifier**

For operation in a 525-line, 30-frame system

	Unit No.1 Oscillator	Unit No.2 Amplifier	
<b>MAXIMUM RATINGS (Design-Maximum Values)</b>			
DC Plate Voltage .....	350	350	volts
Peak Positive-Pulse Plate Voltage# .....	—	1800	volts
Peak Negative-Pulse Grid Voltage .....	—400	—250	volts
Peak Cathode Current .....	—	120	mA
Average Cathode Current .....	—	35	mA
Plate Dissipation .....	1	5.5	watts
<b>MAXIMUM CIRCUIT VALUES</b>			
Grid-Circuit Resistance .....	2.2	2.2†	megohms

# Pulse duration must not exceed 15% of a vertical scanning cycle (2.5 milliseconds).

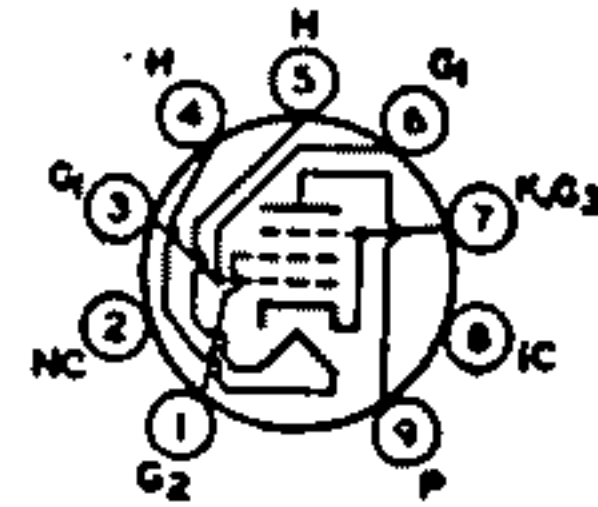
† For cathode-bias operation.

**6CZ5**

5CZ5

**BEAM POWER TUBE**

Miniature type used as a vertical-deflection amplifier in high-efficiency deflection circuits of color and black-and-white television receivers and in the audio output stage of television and radio receivers. Outlines section, 6G; requires miniature 9-contact socket. Type 5CZ5 is identical with type 6CZ5 except for heater ratings.



9HN

	5CZ5	6CZ5	
Heater Voltage (ac/dc) .....	4.7	6.3	volts
Heater Current .....	0.6	0.45	ampere
Heater Warm-up Time (Average) .....	11	11	seconds
Heater-Cathode Voltage:			
Peak value .....	±200 max	±200 max	volts
Average value .....	100 max	100 max	volts
Direct Interelectrode Capacitances:			
Grid No.1 to Plate .....		0.4 max	pF
Grid No.1 to Cathode, Heater, Grid No.2, and Grid No.3 .....		9	pF
Plate to Cathode, Heater, Grid No.2, and Grid No.3 .....		6	pF

**Class A<sub>1</sub> Amplifier**

	5CZ5	6CZ5	
<b>CHARACTERISTICS</b>			
Plate Voltage .....	75	250	volts
Grid-No.2 Voltage .....	250	250	volts
Grid-No.1 Voltage .....	0	—15	volts
Plate Resistance .....	—	7200	ohms
Transconductance .....	—	4500	μmhos
Plate Current .....	130*	48	mA
Grid-No.2 Current .....	16*	4.0	mA
Grid-No.1 Voltage (Approx.) for plate current of 100 μA .....	—	—40	volts

**Vertical-Deflection Amplifier**

For operation in a 525-line, 30-frame system

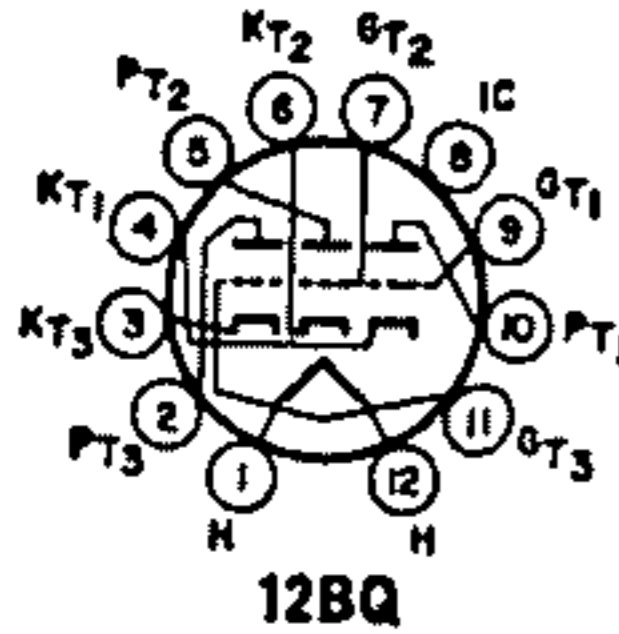
<b>MAXIMUM RATINGS (Design-Maximum Values)</b>		
DC Plate Voltage .....	350	volts
Peak Positive-Pulse Plate Voltage# .....	2200	volts
Grid-No.2 (Screen-Grid) Voltage .....	315	volts
Peak Negative-Pulse Grid-No.1 (Control-Grid) Voltage .....	—275	volts
Peak Cathode Current .....	155	mA
Average Cathode Current .....	45	mA
Plate Dissipation .....	10	watts
Grid-No.2 Input .....	2.2	watts
Bulb Temperature (At hottest point) .....	250	°C
<b>MAXIMUM CIRCUIT VALUES</b>		
Grid-No.1-Circuit Resistance:		
For fixed-bias operation .....	0.5	megohm
For cathode-bias operation .....	1.0	megohm

# Pulse duration must not exceed 15% of a vertical scanning cycle (2.5 milliseconds).  
 \* This value can be measured by a method involving a recurrent waveform such that the maximum ratings of the tube will not be exceeded.

Refer to chart at end of section. **6D6**

Refer to chart at end of section. **6D7**

Refer to chart at end of section. **6D8G**



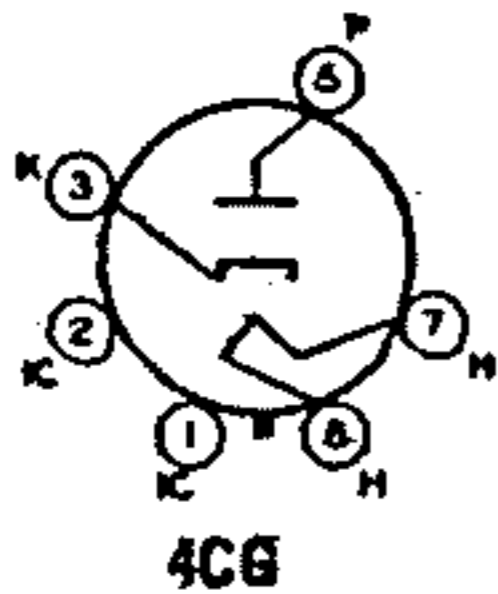
**HIGH-MU TRIPLE TRIODE 6D10**

Duodecar type used in oscillator-mixer, grounded-grid amplifier, and automatic-frequency-control circuits. Outlines section, 8A; requires duodecar 12-contact socket. Heater: volts (ac/dc), 6.3; amperes, 0.45; maximum heater-cathode volts,  $\pm 200$  peak, 100 average.

**Class A<sub>1</sub> Amplifier**

<b>MAXIMUM RATINGS (Design-Maximum Values, Each Triode Unit)</b>		
Plate Voltage .....	330	volts
Grid Voltage:		
Positive-bias value .....	0	volts
Negative-bias value .....	-50	volts
Plate Dissipation .....	2	watts
Total Plate Dissipation (All plates) .....	6	watts
<b>CHARACTERISTICS (Each Triode Unit)</b>		
Plate Voltage .....	125	volts
Grid Voltage .....	-1	volts
Amplification Factor .....	57	
Plate Resistance (Approx.) .....	13600	ohms
Transconductance .....	4200	$\mu$ mhos
Plate Current .....	4.2	mA
Grid Voltage (Approx.) for plate current of 20 $\mu$ A .....	-4	volts

**HALF-WAVE VACUUM RECTIFIER 6DA4**  
12D4, 17D4



Glass octal type used as damper tube in horizontal-deflection circuits of television receivers. Outlines section, 13D; requires octal socket. May be supplied with pin No.1 omitted. Socket terminals 1, 2, 4, and 6 should not be used as tie points. This tube, like other power-handling tubes, should be adequately ventilated. Types 12D4 and 17D4 are identical with type 6DA4 except for heater ratings.

Heater Voltage (ac/dc) .....	6DA4	12D4	17D4	
Heater Current .....	1.2	0.6	0.45	amperes
Heater Warm-up Time (Average) .....	—	.11	.11	seconds

**Damper Service**

For operation in a 525-line, 30-frame system

<b>MAXIMUM RATINGS (Design-Maximum Values)</b>				
Peak Inverse Plate Current# .....	4400			volts
Peak Plate Current .....	900			mA
Average Plate Current .....	155			mA
Plate Dissipation .....	5.5			watts
Heater-Cathode Voltage:				
Peak value .....	+300	-4400		volts
Average value .....	+100	-900		volts

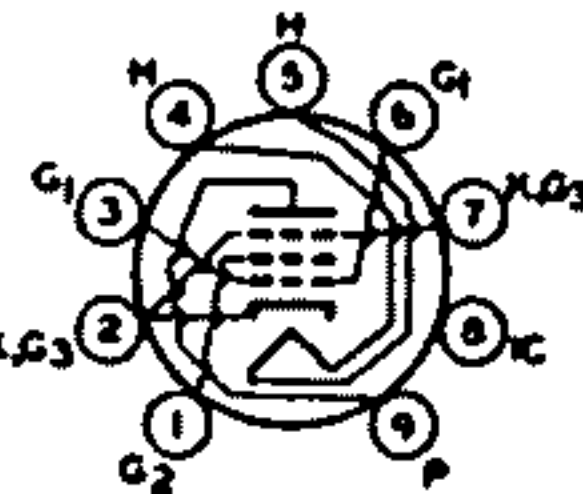
# Pulse duration must not exceed 15% of a horizontal scanning cycle (10 microseconds).

# 6DB5

12DB5

## BEAM POWER TUBE

Miniature type used as vertical-deflection-amplifier tube in television receivers. Outlines section, 6F; requires miniature 9-contact socket. Type 12DB5 is identical with type 6DB5 except for heater ratings.



9GR

	6DB5	12DB5	
Heater Voltage (ac/dc) .....	8.8	12.6	volts
Heater Current .....	1.2	0.6	ampere
Heater Warm-up Time (Average) .....	—	11	seconds
Heater-Cathode Voltage:			
Peak value .....	±200 max	±200 max	volts
Average value .....	100 max	100 max	volts

### Class A<sub>1</sub> Amplifier

#### MAXIMUM RATINGS (Design-Center Values)

Plate Voltage .....	300	volts
Grid-No.2 (Screen-Grid) Voltage .....	150	volts
Plate Dissipation .....	10	watts
Grid-No.2 Input .....	1.25	watts

#### TYPICAL OPERATION

Plate Supply Voltage .....	200	volts
Grid-No.2 Supply Voltage .....	125	volts
Cathode-Bias Resistor .....	180	ohms
Peak AF Grid-No.1 Voltage .....	8.5	volts
Zero-Signal Plate Current .....	46	mA
Maximum-Signal Plate Current .....	47	mA
Zero-Signal Grid-No.2 Current .....	2.2	mA
Maximum-Signal Grid-No.2 Current .....	8.5	mA
Plate Resistance (Approx.) .....	28000	ohms
Transconductance .....	8000	amhos
Load Resistance .....	4000	ohms
Total Harmonic Distortion .....	10	per cent
Maximum-Signal Power Output .....	3.8	watts

#### MAXIMUM CIRCUIT VALUES

Grid-No.1 Circuit Resistance:		
For fixed-bias operation .....	0.1	megohm
For cathode-bias operation .....	2.2	megohms

### Vertical-Deflection Amplifier

For operation in a 525-line, 30-frame system

#### MAXIMUM RATINGS (Design-Center Values)

DC Plate Voltage .....	300	volts
Peak Positive-Pulse Plate Voltage (Absolute Maximum)* .....	2000*	volts
DC Grid-No.2 (Screen-Grid) Voltage .....	150	volts
Peak Negative-Pulse Grid-No.1 (Control-Grid) Voltage .....	-250	volts
Peak Cathode Current .....	200	mA
Average Cathode Current .....	55	mA
Plate Dissipation .....	10	watts
Grid-No.2 Input .....	1.25	watts

#### MAXIMUM CIRCUIT VALUES

Grid-No.1-Circuit Resistance:		
For fixed-bias operation .....	0.1	megohm
For cathode-bias operation .....	2.2	megohms

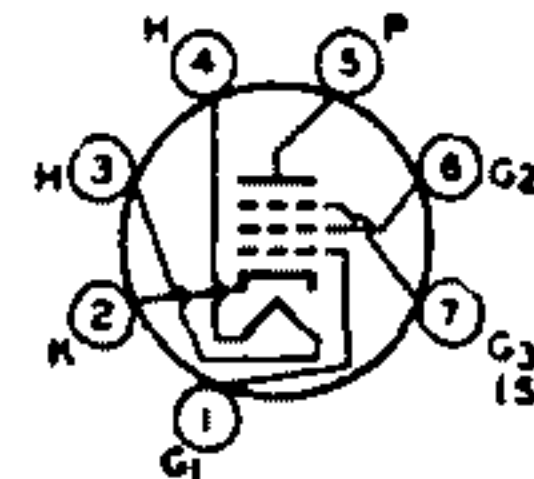
\* Pulse duration must not exceed 15% of a vertical scanning cycle (2.5 milliseconds).

\* Under no circumstances should this absolute maximum value be exceeded.

# 6DC6

## SHARP-CUTOFF PENTODE

Miniature type used in the gain-controlled picture if stages of color and black-and-white television receivers and as an rf amplifier in the tuners of such receivers. Outlines section, 5C; requires 7-contact miniature socket.



7CM



Heater Voltage (ac/dc) .....	6.3	volts
Heater Current .....	0.8	ampere
Heater-Cathode Voltage:		
Peak value .....	±200 max	volts
Average value .....	100 max	volts
Direct Interelectrode Capacitances:		
Grid No.1 to Plate .....	0.02 max	pF
Grid No.1 to Cathode, Heater, Grid No.2, Grid No.3, and Internal Shield .....	6.5	pF
Plate to Cathode, Heater, Grid No.2, Grid No.3, and Internal Shield .....	2	pF

**Class A<sub>1</sub> Amplifier**

**MAXIMUM RATINGS (Design-Center Values)**

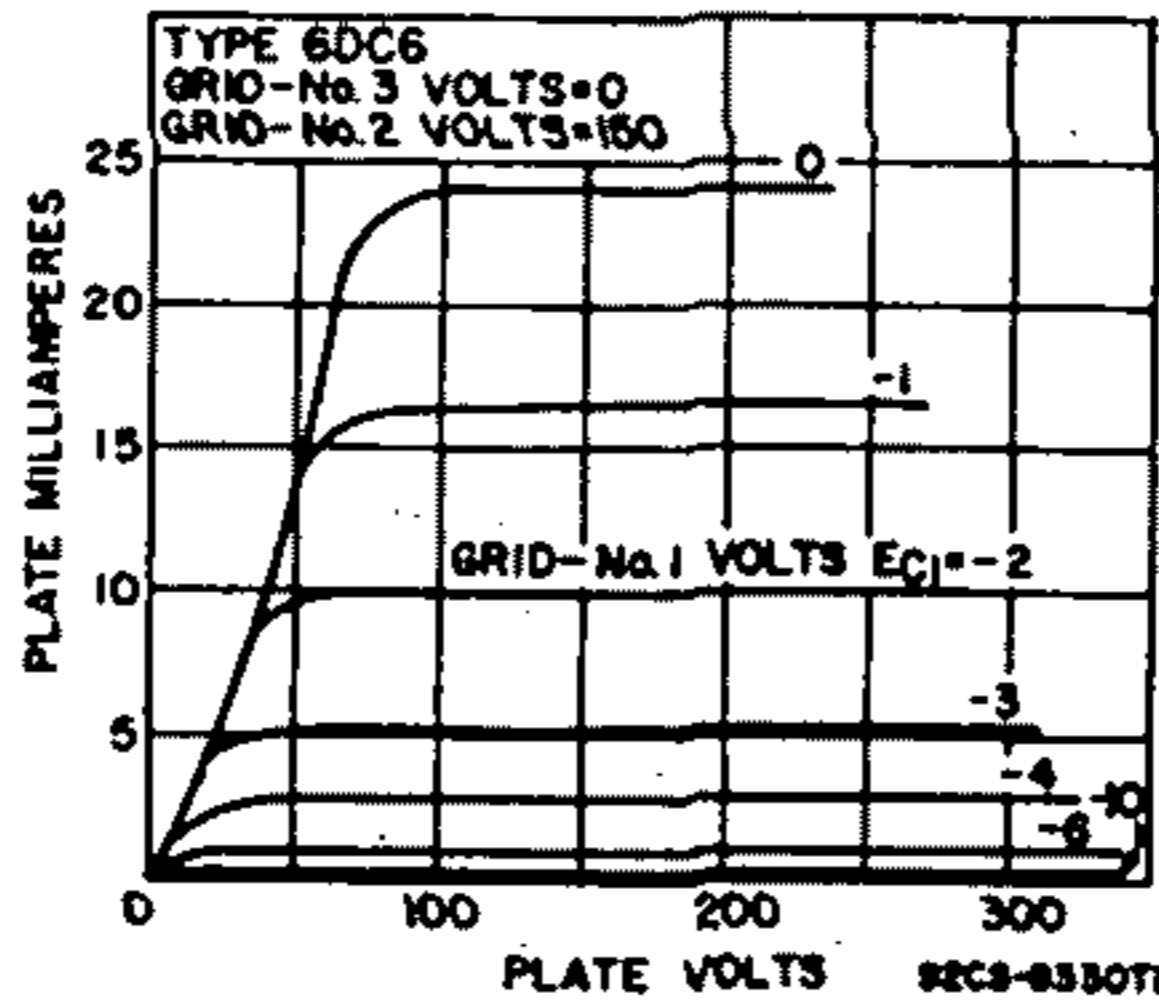
Plate Voltage .....	800	volts
Grid-No.3 (Suppressor-Grid) Voltage, Positive value .....	0	volts
Grid-No.2 Supply Voltage .....	300	volts
Grid-No.2 (Screen-Grid) Voltage .....	See curve page 96	
Grid-No.1 (Control-Grid) Voltage, Positive-bias value .....	0	volts
Plate Dissipation .....	2	watts
Grid-No.2 Input:		
For grid-No.2 voltages up to 150 volts .....	0.5	watt
For grid-No.2 voltages between 150 and 300 volts .....	See curve page 96	

**CHARACTERISTICS**

Plate Supply Voltage .....	200	volts
Grid No.3 .....	Connected to cathode at socket	
Grid-No.2 Supply Voltage .....	150	volts
Cathode-Bias Resistor .....	180	ohms
Plate Resistance (Approx.) .....	0.6	megohm
Transconductance .....	5500	μmhos
Plate Current .....	9	mA
Grid-No.2 Current .....	3	mA
Grid-No.1 Voltage (Approx.) for transconductance of 50 μmhos ..	-12.5	volts

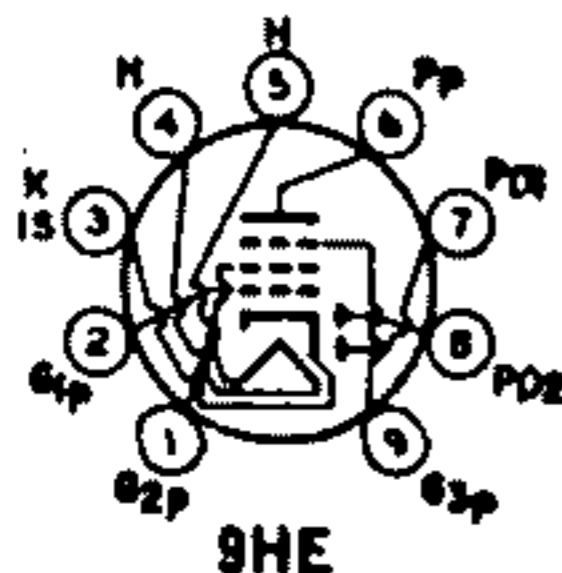
**MAXIMUM CIRCUIT VALUES**

Grid-No.1-Circuit Resistance:		
For fixed-bias operation .....	0.25	megohm
For cathode-bias operation .....	1.0	megohm



See chart at end of section.

6DC8



**TWIN DIODE—SEMIREMOTE-CUTOFF PENTODE**

Miniature type used as rf- and if-amplifier tube in radio and television receivers. Outlines section, 6E; requires 9-contact socket.

**6DC8/  
EBF89**

Heater Voltage (ac/dc) .....	6.3	volts
Heater Current .....	0.8	ampere
Peak Heater-Cathode Voltage .....	±100 max	volts

Direct Interelectrode Capacitances:

Pentode Unit:		
Grid No.1 to Plate .....	0.0025 max	pF
Grid No.1 to All Other Electrodes Except Plate .....	5	pF
Plate to All Other Electrodes Except Grid No.1 .....	5.2	pF
Grid No.1 to Heater .....	0.05 max	pF
Plate of Each Diode Unit to All Other Electrodes .....	2.5	pF
Plate of Diode Unit No.1 to Plate of Diode Unit No.2 .....	0.25 max	pF
Plate of Diode Unit No.1 to Heater .....	0.015 max	pF
Plate of Diode Unit No.2 to Heater .....	0.008 max	pF
Plate of Diode Unit No.1 to Pentode Grid No.1 .....	0.0008 max	pF
Plate of Diode Unit No.2 to Pentode Grid No.1 .....	0.001 max	pF
Plate of Diode Unit No.1 to Pentode Plate .....	0.15 max	pF
Plate of Diode Unit No.2 to Pentode Plate .....	0.025 max	pF

Pentode Unit as Class A<sub>1</sub> Amplifier

MAXIMUM RATINGS (Design-Center Values)

Plate Supply Voltage .....	550	volts
Plate Voltage .....	300	volts
Grid-No.2 Voltage:		
With plate current greater than 8 mA .....	125	volts
With plate current less than 4 mA .....	300	volts
Cathode Current .....	16.5	mA
Plate Dissipation .....	2.25	watts
Grid-No.2 Input .....	0.45	watts

CHARACTERISTICS

Plate Voltage .....	200	250	volts
Grid No.3 .....	Connected to cathode at socket		
Grid-No.2 Voltage .....	100	100	volts
Grid-No.1 Voltage .....	-1.5	-2	volts
Mu Factor, Grid No.2 to Grid No.1 .....	20	20	
Plate Resistance (Approx.) .....	0.6	1	megohm
Transconductance .....	4500	3800	μmhos
Plate Current .....	11	9	mA
Grid-No.2 Current .....	3.3	2.7	mA
Transconductance, at grid-No.1 voltage of -20 volts .....	120	200	μmhos

MAXIMUM CIRCUIT VALUE

Grid-No.1-Circuit Resistance .....	3	megohms
------------------------------------	---	---------

Diode Units (Each Unit)

MAXIMUM RATINGS (Design-Center Values)

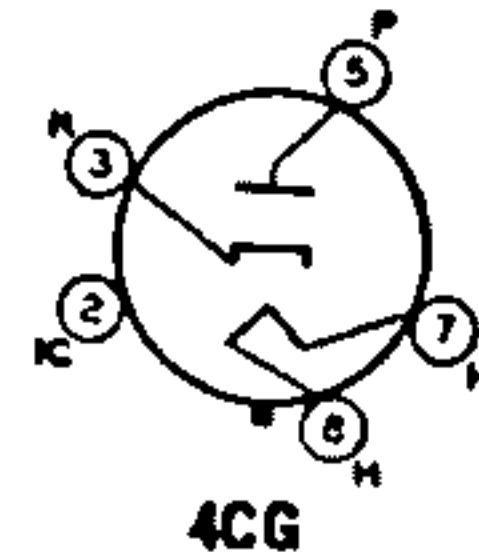
Peak Inverse Plate Voltage .....	200	volts
Peak Plate Current .....	5	mA
Average Plate Current .....	0.8	mA

**6DE4**

17DE4, 22DE4

**HALF-WAVE  
VACUUM RECTIFIER**

Glass octal type used as damper tube in horizontal-deflection circuits of television receivers. Outlines section, 13G; requires octal socket. Socket terminals 1, 2, 4, and 6 should not be used as tie points. This tube, like other power-handling tubes, should be adequately ventilated. Types 17DE4 and 22DE4 are identical with type 6DE4 except for heater ratings.



	<b>6DE4</b>	<b>17DE4</b>	<b>22DE4</b>	
Heater Voltage (ac/dc) .....	6.3	17	22.4	volts
Heater Current .....	1.6	0.6	0.45	amperes
Heater Warm-up Time (Average) .....	—	11	11	seconds
Direct Interelectrode Capacitances (Approx.):				
Plate to Cathode and Heater .....			8.5	pF
Cathode to Plate and Heater .....			11.5	pF
Heater to Cathode .....			4	pF

Damper Service

For operation in a 525-line, 30-frame system

MAXIMUM RATINGS (Design-Maximum Values)

Peak Inverse Plate Voltage .....	5500	volts
Peak Plate Current .....	1100	mA
Average Plate Current .....	180	mA
Plate Dissipation .....	6.5	watts

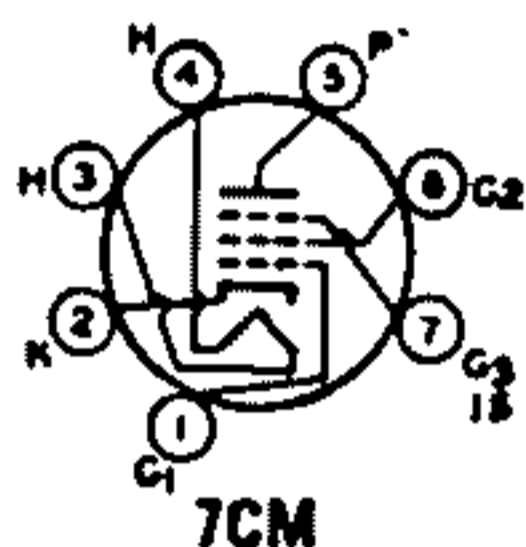
Heater-Cathode Voltage:

Peak value .....	+300	-5500	volts
Average value .....	+100	-900	volts

CHARACTERISTICS, Instantaneous Value

Tube Voltage Drop for plate current of 350 mA .....	34	volts
---	----	-------

\* Pulse duration must not exceed 15% of a horizontal scanning cycle (10 microseconds).



SHARP-CUTOFF PENTODE

6DE6  
4DE6

Miniature type used in the gain-controlled picture if stages of television receivers utilizing an intermediate frequency in the order of 40 MHz and as an rf amplifier in vhf television tuners. Outlines section, 5C; requires miniature 7-contact socket. Type 4DE6 is identical with type 6DE6 except for heater ratings.

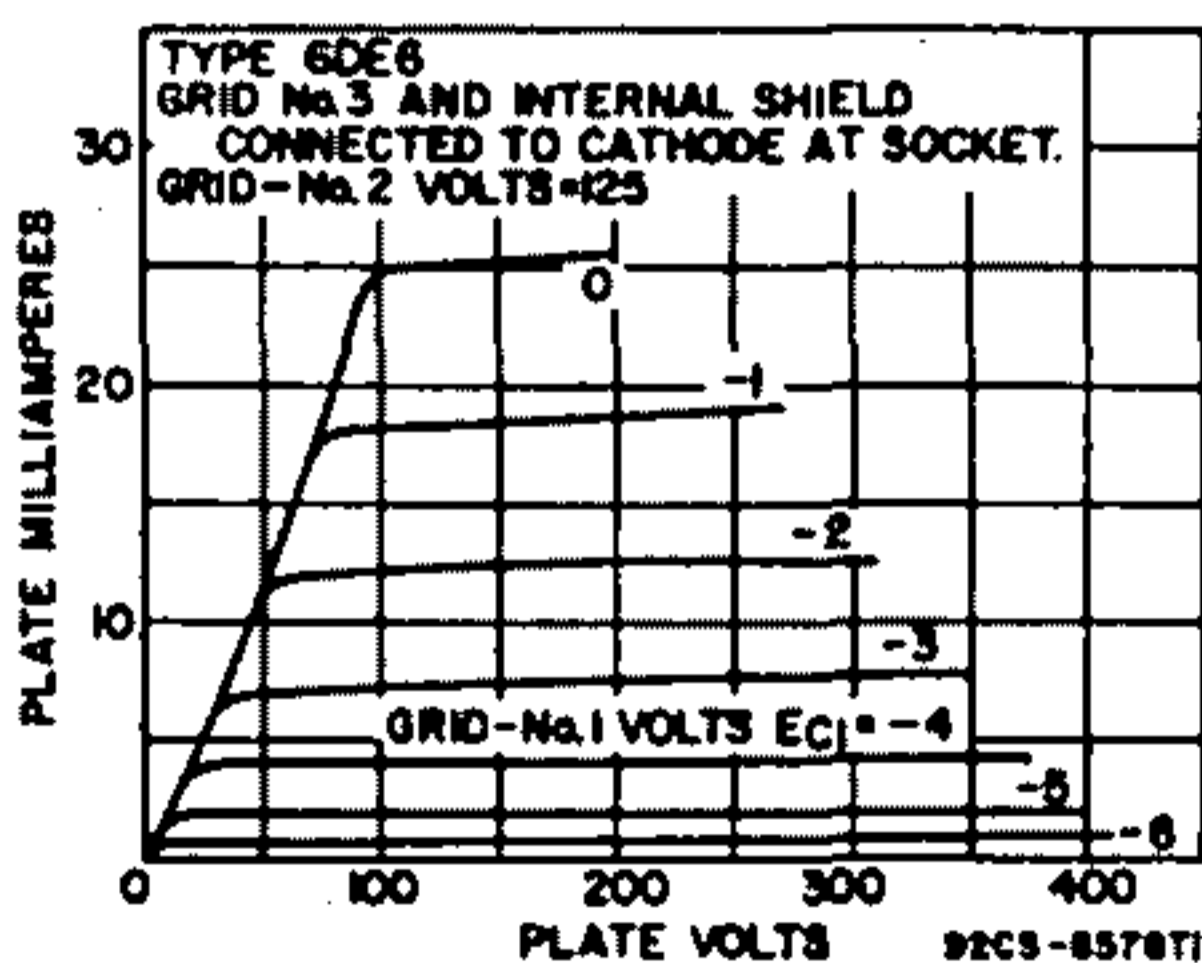
Heater Voltage (ac/dc) .....	4DE6	6DE6	
Heater Current .....	4.2	6.3	volts
Heater Warm-up Time (Average) .....	0.45	0.8	ampere
Heater-Cathode Voltage:			seconds
Peak value .....	±200 max	±200 max	volts
Average value .....	100 max	100 max	volts
Direct Interelectrode Capacitances:	Unshielded	Shielded*	
Grid No.1 to Plate .....	0.025 max	0.015 max	pF
Grid No.1 to Cathode, Heater, Grid No.2, Grid No.3, and Internal Shield .....	6.5	6.5	pF
Plate to Cathode, Heater, Grid No.2, Grid No.3, and Internal Shield .....	2	3	pF

\* With external shield connected to cathode.

Class A<sub>1</sub> Amplifier

MAXIMUM RATINGS (Design-Maximum Values)

Plate Voltage .....	330	volts
Grid-No.3 (Suppressor-Grid) Voltage, Positive value .....	0	volts
Grid-No.2 (Screen-Grid) Supply Voltage .....	330	volts
Grid-No.2 Voltage .....	See curve page 96	
Grid-No.1 (Control-Grid) Voltage, Positive-bias value .....	0	volts
Plate Dissipation .....	2.3	watts
Grid-No.2 Input:		
For grid-No.2 voltages up to 165 volts .....	0.55	watt
For grid-No.2 voltages between 165 and 330 volts .....	See curve page 96	



CHARACTERISTICS

Plate Supply Voltage .....	125	volts
Grid No.3 .....	Connected to cathode at socket	
Grid-No.2 Supply Voltage .....	125	volts
Cathode-Bias Resistor .....	56	ohms
Plate Resistance (Approx.) .....	0.25	megohm
Transconductance .....	8000	μmhos



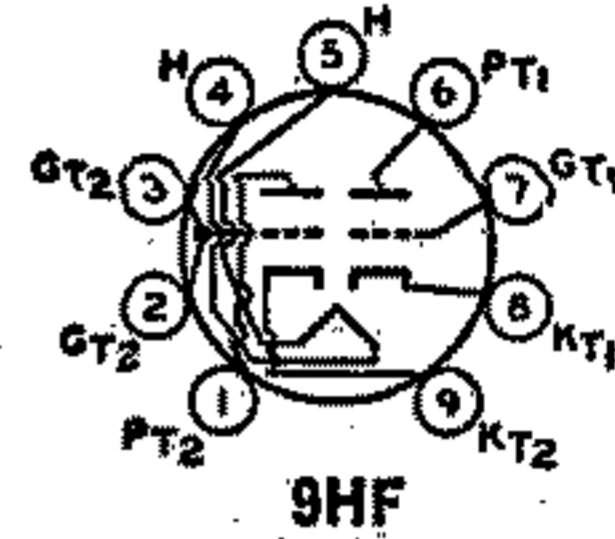
Transconductance for grid-No.1 volts of —5.5 and cathode resistor of 0 ohms .....	700	μmhos
Plate Current .....	15.5	mA
Grid-No.2 Current .....	4.2	mA
Grid-No.1 Voltage (Approx.) for plate current of 20 μA .....	—9	volts

## 6DE7

10DE7, 13DE7

### DUAL TRIODE

Miniature type used as combined vertical oscillator and vertical-deflection amplifier in television receivers. Unit No.1 is used as a blocking oscillator in vertical-deflection circuits, and unit No.2 is used as a vertical-deflection amplifier. Outlines section, 6E; requires miniature 9-contact socket. For curve of average plate characteristics, Unit No.2, refer to type 6DR7. Types 10DE7 and 13DE7 are identical with type 6DE7 except for heater ratings.

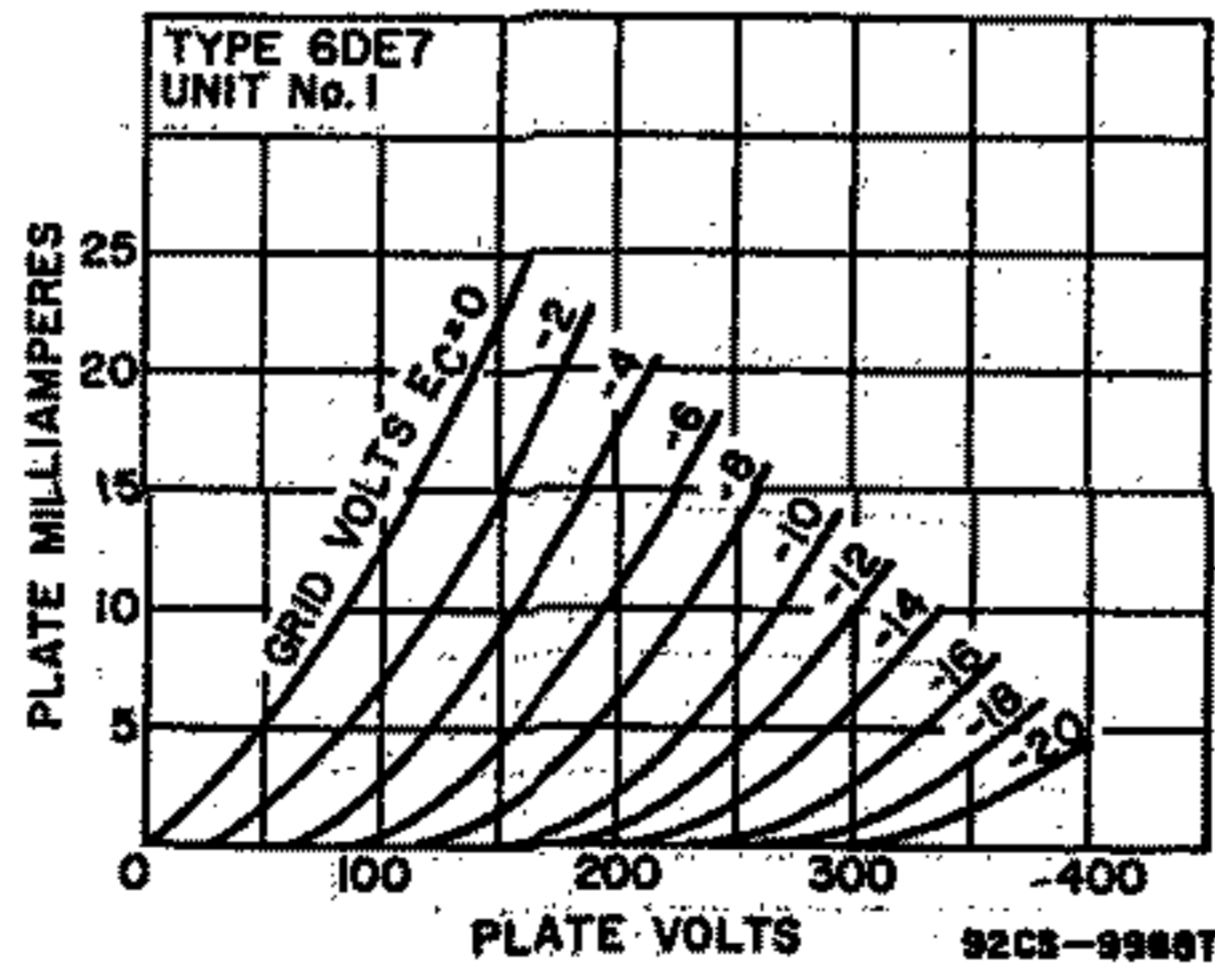


9HF

Heater Voltage (ac/dc) .....	6.3	9.7	13	volts
Heater Current .....	0.9	0.6	0.45	ampere
Heater Warm-up Time (Average) .....	—	11	11	seconds
Heater-Cathode Voltage:				
Peak value .....	±200 max	±200 max	±200 max	volts
Average value .....	100 max	100 max	100 max	volts
Direct Interelectrode Capacitances (Approx.):	Unit No.1	Unit No.2		
Grid to Plate .....	4	8.5		pF
Grid to Cathode and Heater .....	2.2	5.5		pF
Plate to Cathode and Heater .....	0.52	1		pF

### Class A<sub>1</sub> Amplifier

<b>CHARACTERISTICS</b>	Unit No.1	Unit No.2	
Plate Voltage .....	250	150	volts
Grid Voltage .....	—11	—17.5	volts
Amplification Factor .....	17.5	6	
Plate Resistance (Approx.) .....	8750	925	ohms
Transconductance .....	2000	6500	μmhos
Plate Current .....	5.5	35	mA
Plate Current for grid voltage of —24 volts .....	—	10	mA
Grid Voltage (Approx.) for plate current of 10 μA .....	—20	—	volts
Grid Voltage (Approx.) for plate current of 50 μA .....	—	—44	volts



### Vertical-Deflection Oscillator and Amplifier

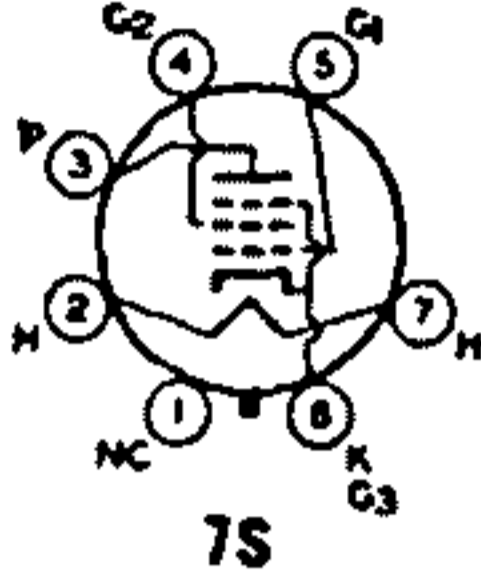
For operation in a 525-line, 30-frame system

<b>MAXIMUM RATINGS (Design-Maximum Values)</b>	Unit No.1 Oscillator	Unit No.2 Amplifier	
DC Plate Voltage .....	330	275	volts
Peak Positive-Pulse Plate Voltage# .....	—	1500	volts
Peak Negative-Pulse Grid Voltage .....	—400	—250	volts
Peak Cathode Current .....	77	175	mA

Average Cathode Current .....	22	50	mA
Plate Dissipation .....	1.5	7	watts

**MAXIMUM CIRCUIT VALUES**

Grid-Circuit Resistance:  
 For grid-resistor bias or cathode-bias operation . . . . . 2.2 2.2 megohms  
 # Pulse duration must not exceed 15% of a vertical scanning cycle (2.5 milliseconds).



**BEAM POWER TUBE**

**6DG6GT**

Glass octal type used as output tube in audio-amplifier applications Outlines section, 13D; requires octal socket. This type may be supplied with pin 1 omitted.

Heater Voltage (ac/dc) .....	6.3	volts
Heater Current .....	1.2	amperes
Heater-Cathode Voltage:		
Peak value .....	±200 max	volts
Average value .....	100 max	volts
Direct Interelectrode Capacitances (Approx.):		
Grid No.1 to Plate .....	0.6	pF
Grid No.1 to Cathode, Heater, Grid No.2, and Grid No.3 .....	15	pF
Plate to Cathode, Heater, Grid No.2, and Grid No.3 .....	10	pF

**Class A, Audio-Frequency Power Amplifier**

**MAXIMUM RATINGS (Design-Center Values)**

Plate Voltage .....	200	volts
Grid-No.2 (Screen-Grid) Voltage .....	125	volts
Plate Dissipation .....	10	watts
Grid-No.2 Input .....	1.25	watts

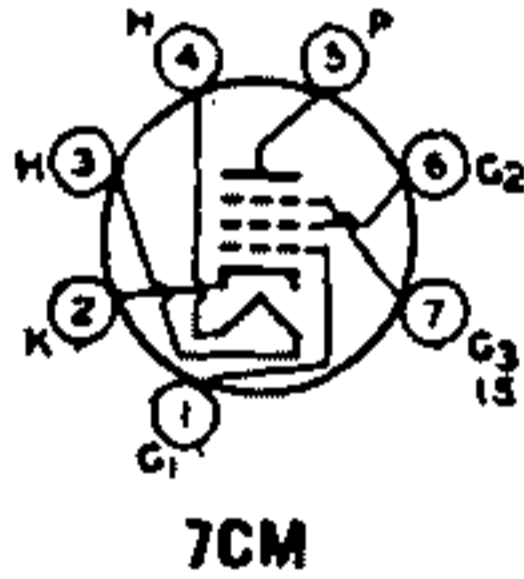
**TYPICAL OPERATION**

Plate Supply Voltage .....	110	200	volts
Grid-No.2 Supply Voltage .....	110	125	volts
Grid-No.1 (Control-Grid) Supply Voltage .....	-7.5	—	volts
Peak AF Grid-No.1 Voltage .....	7.5	8.5	volts
Cathode-Bias Resistor .....	—	180	ohms
Zero-Signal Plate Current .....	49	46	mA
Maximum-Signal Plate Current .....	50	47	mA
Zero-Signal Grid-No.2 Current .....	4	2.2	mA
Maximum-Signal Grid-No.2 Current .....	10	8.5	mA
Plate Resistance (Approx.) .....	18000	28000	ohms
Transconductance .....	8000	8000	μmhos
Load Resistance .....	2000	4000	ohms
Total Harmonic Distortion .....	10	10	per cent
Maximum-Signal Power Output .....	2.1	3.8	watts

**MAXIMUM CIRCUIT VALUES**

Grid-No.1-Circuit Resistance:  
 For fixed-bias operation .....
 0.1 | megohm |

For cathode-bias operation .....
 0.5 | megohm |



**SHARP-CUTOFF PENTODE**

**6DK6**

3DK6, 4DK6, 12DK6

Miniature type used as if-amplifier tube in color and black-and-white television receivers. Outlines section, 5C; requires miniature 7-contact socket. Types 3DK6, 4DK6, and 12DK6 are identical with type 6DK6 except for heater ratings.

Heater Voltage (ac/dc) .....	3DK6	4DK6	6DK6	12DK6	volts
Heater Current .....	3.15	4.2	6.3	12.6	ampere
Heater Warm-up Time (Average) .....	0.6	0.45	0.3	0.15	seconds
Heater-Cathode Voltage:					
Peak value .....	{ +200 max	±200 max	±200 max	±200 max	volts
Average value .....	{ -300 max	100 max	100 max	100 max	volts
100 max .....					
Direct Interelectrode Capacitances:					
Grid No.1 to Plate .....			0.025 max		pF
Grid No.1 to Cathode, Heater, Grid No.2, Grid No.3 and Internal Shield .....			6.8		pF
Plate to Cathode, Heater, Grid No.2, Grid No.3, and Internal Shield .....			1.9		pF

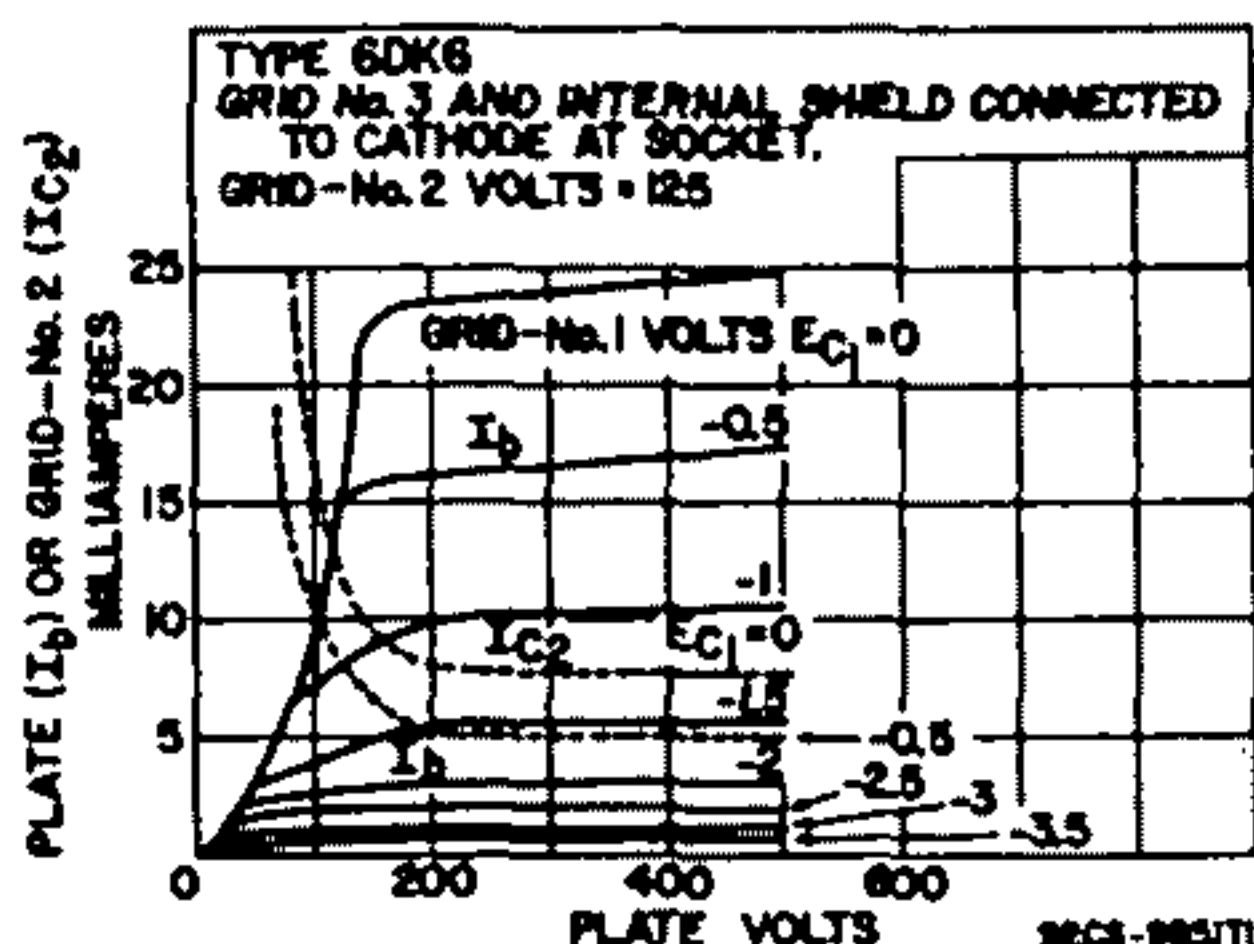
**Class A<sub>1</sub> Amplifier**

**MAXIMUM RATINGS (Design-Maximum Values)**

Plate Voltage .....	330	volts
Grid-No.3 (Suppressor-Grid) Voltage, Positive value .....	0	volts
Grid-No.2 (Screen-Grid) Supply Voltage .....	330	volts
Grid-No.2 Voltage .....	See curve page 96	
Grid-No.1 (Control-Grid) Voltage, Positive-bias value .....	0	volts
Plate Dissipation .....	2.3	watts
Grid-No.2 Input:		
For grid-No.2 voltages up to 165 volts .....	0.55	watt
For grid-No.2 voltages between 165 and 330 volts .....	See curve page 96	

**CHARACTERISTICS**

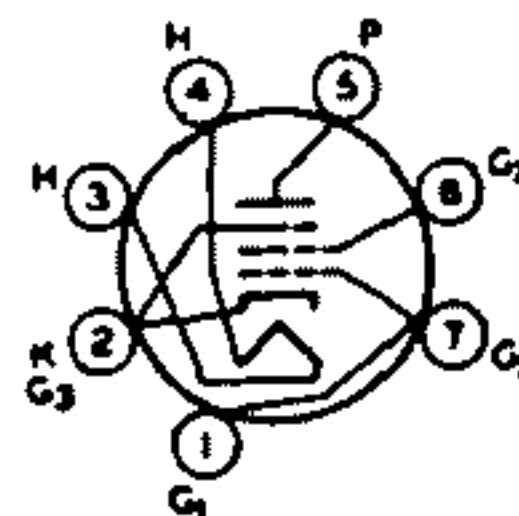
Plate Supply Voltage .....	125	volts
Grid No.3 .....	Connected to cathode at socket	
Grid-No.2 Supply Voltage .....	125	volts
Cathode-Bias Resistor .....	56	ohms
Plate Resistance (Approx.) .....	0.35	megohm
Transconductance .....	9800	μmhos
Plate Current .....	12	mA
Grid-No.2 Current .....	3.8	mA
Grid-No.1 Voltage (Approx.) for plate current of 20 μA .....	-8.5	volts



**6DL5**

**POWER PENTODE**

Miniature type used in audio output applications in automobile radios. Outlines section, 5E; requires miniature 9-contact socket. Heater: volts 6.3; amperes 0.2; maximum heater-cathode volts, ±100.



7DQ

**Class A<sub>1</sub> Amplifier**

**MAXIMUM RATINGS (Design-Maximum Values)**

Plate Supply Voltage .....	550	volts
Plate Voltage .....	300	volts
Grid-No.2 (Screen-Grid) Supply Voltage .....	550	volts
Grid-No.2 Voltage .....	300	volts
Cathode Current .....	35	mA
Plate Dissipation .....	2.5	watts
Grid-No.2 Input .....	6	watts

**TYPICAL OPERATION**

Plate Voltage .....	200	250	volts
Grid-No.2 Voltage .....	200	250	volts
RMS AF Grid-No.1 (Control-Grid) Voltage .....	4.5	5	volts
Cathode-Bias Resistor .....	230	320	ohms
Plate Current .....	23	24	mA
Grid-No.2 Current .....	4.2	4.5	mA
Load Resistance .....	8000	10000	ohms
Total Harmonic Distortion .....	12	12	per cent
Power Output .....	2.3	3.0	watts

**MAXIMUM CIRCUIT VALUE**

Grid-No.1-Circuit Resistance, for cathode-bias operation .....	3	megohms
--	---	---------



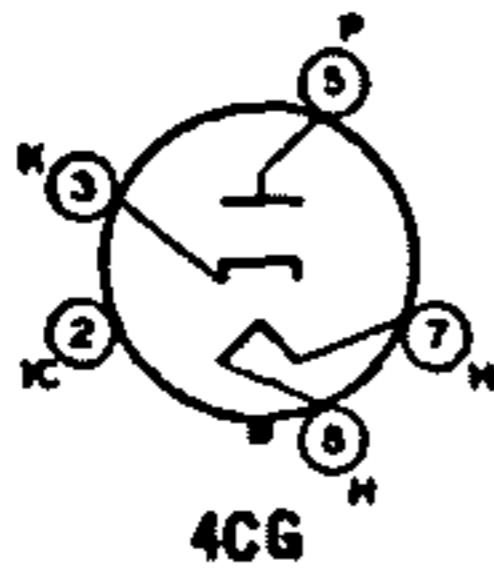
See chart at end of section.

6DM4

**HALF-WAVE  
VACUUM RECTIFIER**

**6DM4A**

12DM4A, 17DM4A



Glass octal type used as damper tube in horizontal-deflection circuits of television receivers. Outlines section, 13G; requires octal socket. Socket terminals 1, 2, 4, and 6 should not be used as tie points. This tube, like other power-handling tubes, should be adequately ventilated. Types 12DM4A and 17DM4A are identical with type 6DM4A except for heater ratings.

	6DM4A	12DM4A	17DM4A	
Heater Voltage (ac/dc)	6.3	12.6	16.8	volts
Heater Current	1.2	0.6	0.45	amperes
Heater Warm-up Time (Average)	—	11	11	seconds

**Damper Service**

For operation in a 525-line, 30-frame system

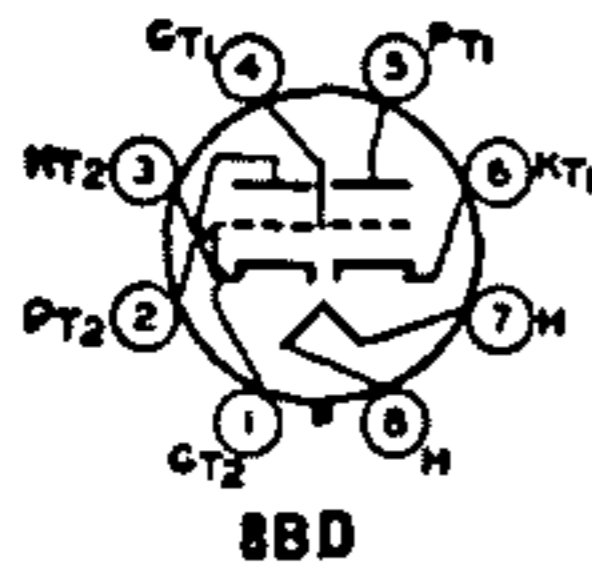
**MAXIMUM RATINGS (Design-Maximum Values)**

Peak Inverse Plate Voltage#	5000	volts	
Peak Plate Current	1200	mA	
Average Plate Current	200	mA	
Plate Dissipation	6.5	watts	
<b>Heater-Cathode Voltage:</b>			
Peak value	+300	—5000	volts
Average value	+100	—900	volts

# Pulse duration must not exceed 15% of a horizontal scanning cycle (10 microseconds).

See chart at end of section.

6DN6



**MEDIUM-MU DUAL TRIODE**

**6DN7**

Glass octal type used as combined vertical-deflection-oscillator and vertical-deflection-amplifier tube in television receivers. Outlines section, 13B; requires octal socket. Heater: volts (ac/dc), 6.3; amperes, 0.9; maximum heater-cathode volts,  $\pm 200$  peak, 100 average.

**Class A<sub>1</sub> Amplifier**

CHARACTERISTICS	Unit No.1	Unit No.2	
Plate Voltage	250	250	volts
Grid Voltage	—8	—9.5	volts
Amplification Factor	22.5	15.4	
Plate Resistance (Approx.)	9000	2000	ohms
Transconductance	2500	7700	$\mu$ mhos
Plate Current	8	41	mA
Grid Voltage (Approx.) for plate current of 10 $\mu$ A	—18	—	volts
Grid Voltage (Approx.) for plate current of 50 $\mu$ A	—	—23	volts

**Vertical-Deflection Oscillator and Amplifier**

For operation in a 525-line, 30-frame system

MAXIMUM RATINGS (Design-Maximum Values)	Unit No.1 Oscillator	Unit No.2 Amplifier	
DC Plate Voltage	350	550	volts
Peak Positive-Pulse Plate Voltage#	—	2500	volts
Peak Negative-Pulse Grid Voltage	—400	—250	mA
Peak Cathode Current	—	150	mA
Average Cathode Current	—	50	mA
Plate Dissipation	1	10	watts

**MAXIMUM CIRCUIT VALUES**

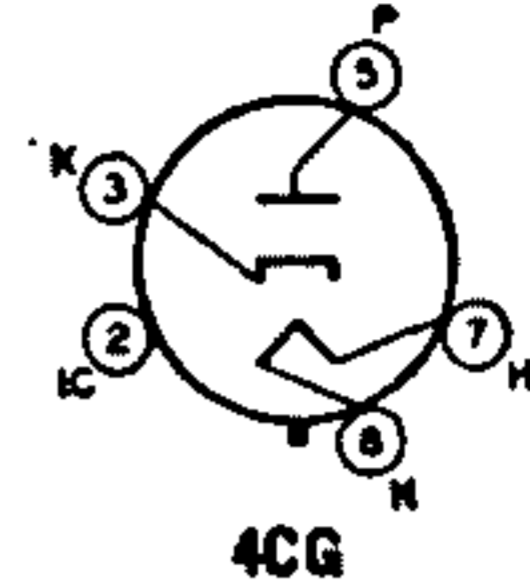
<b>Grid-Circuit Resistance:</b>			
For fixed-bias operation	2.2	2.2	megohms
For cathode-bias operation	2.2	—	megohms

# Pulse duration must not exceed 15% of a vertical scanning cycle (2.5 milliseconds).

# 6DQ4

## HALF-WAVE VACUUM RECTIFIER

Glass octal type used as damper tube in horizontal-deflection circuits of television receivers. Outlines section, 13F; requires octal socket. Socket terminals 1, 2, 4, and 6 should not be used as tie points. Heater: volts (ac/dc), 6.3; amperes, 1.2.



### Damper Service

For operation in a 525-line, 30-frame system

#### MAXIMUM RATINGS (Design-Maximum Values)

Peak Inverse Plate Voltage#	5500	volts
Peak Plate Current	1000	mA
Average Plate Current	175	mA
Plate Dissipation	6	watts
Heater-Cathode Voltage:		
Peak value	+300      -5500	volts
Average value	+100      -900	volts

#### CHARACTERISTICS, Instantaneous Value

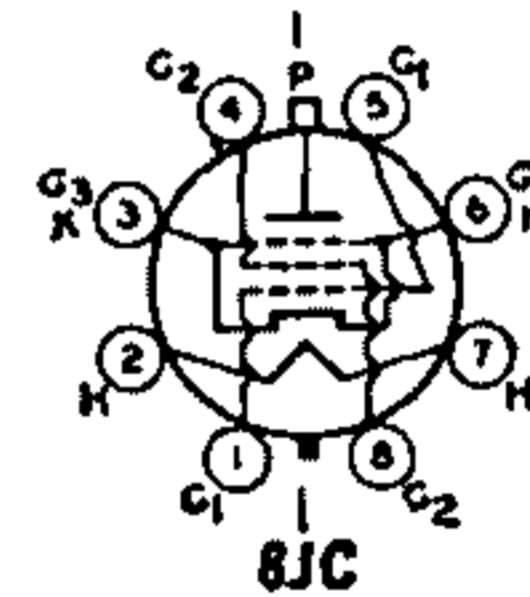
Tube Voltage Drop for plate current of 250 mA	32	volts
---	----	-------

# Pulse duration must not exceed 15% of a horizontal scanning cycle (10 microseconds).

# 6DQ5

## BEAM POWER TUBE

Glass octal type used as horizontal-deflection amplifier in color and black-and-white television receivers. Outlines section, 21B; requires octal socket.



Heater Voltage (ac/dc)	6.3	volts
Heater Current	2.6	amperes
Heater-Cathode Voltage:		
Peak value	±200 max	volts
Average value	100 max	volts
Direct Interelectrode Capacitances (Approx.):		
Grid No.1 to Plate	0.5	pF
Grid No.1 to Cathode, Heater, Grid No.2, and Grid No.3	23	pF
Plate to Cathode, Heater, Grid No.2, and Grid No.3	11	pF

### Class A<sub>1</sub> Amplifier

#### CHARACTERISTICS

	Pentode Connection		Triode Connection	
Plate Voltage	70	175	125	volts
Grid No.2 (Screen-Grid) Voltage	125	125	—	volts
Grid No.1 (Control-Grid) Voltage	0	-25	-25	volts
Amplification Factor	—	—	3.3	
Plate Resistance (Approx.)	—	5500	—	ohms
Transconductance	—	10500	—	μmhos
Plate Current	550*	110	—	mA
Grid-No.2 Current	42*	5	—	mA
Grid-No.1 Voltage (Approx.) for plate mA = 1	—	-55	—	volts

\* Grid No.2 connected to plate.

\* These values can be measured by a method involving a recurrent waveform such that the maximum ratings of the tube will not be exceeded.

### Horizontal-Deflection Amplifier

For operation in a 525-line, 30-frame system

#### MAXIMUM RATINGS (Design-Maximum Values)

DC Plate Voltage	990	volts
Peak Positive-Pulse Plate Voltage#	6500	volts
Peak Negative-Pulse Plate Voltage	-1100	volts
DC Grid-No.2 (Screen-Grid) Voltage	190	volts
Peak Negative-Pulse Grid-No.1 (Control-Grid) Voltage	-250	volts
Peak Cathode Current	1100	mA
Average Cathode Current	315	mA
Grid-No.2 Input	3.2	watts

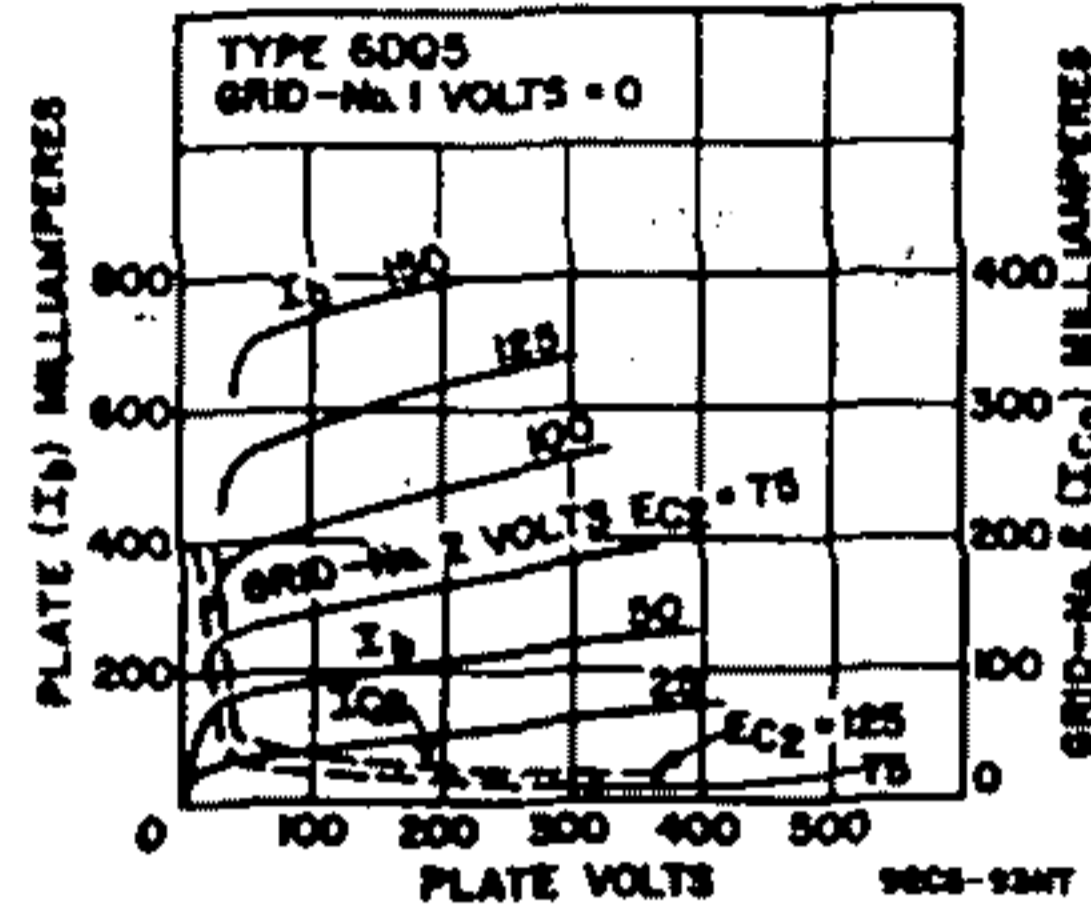
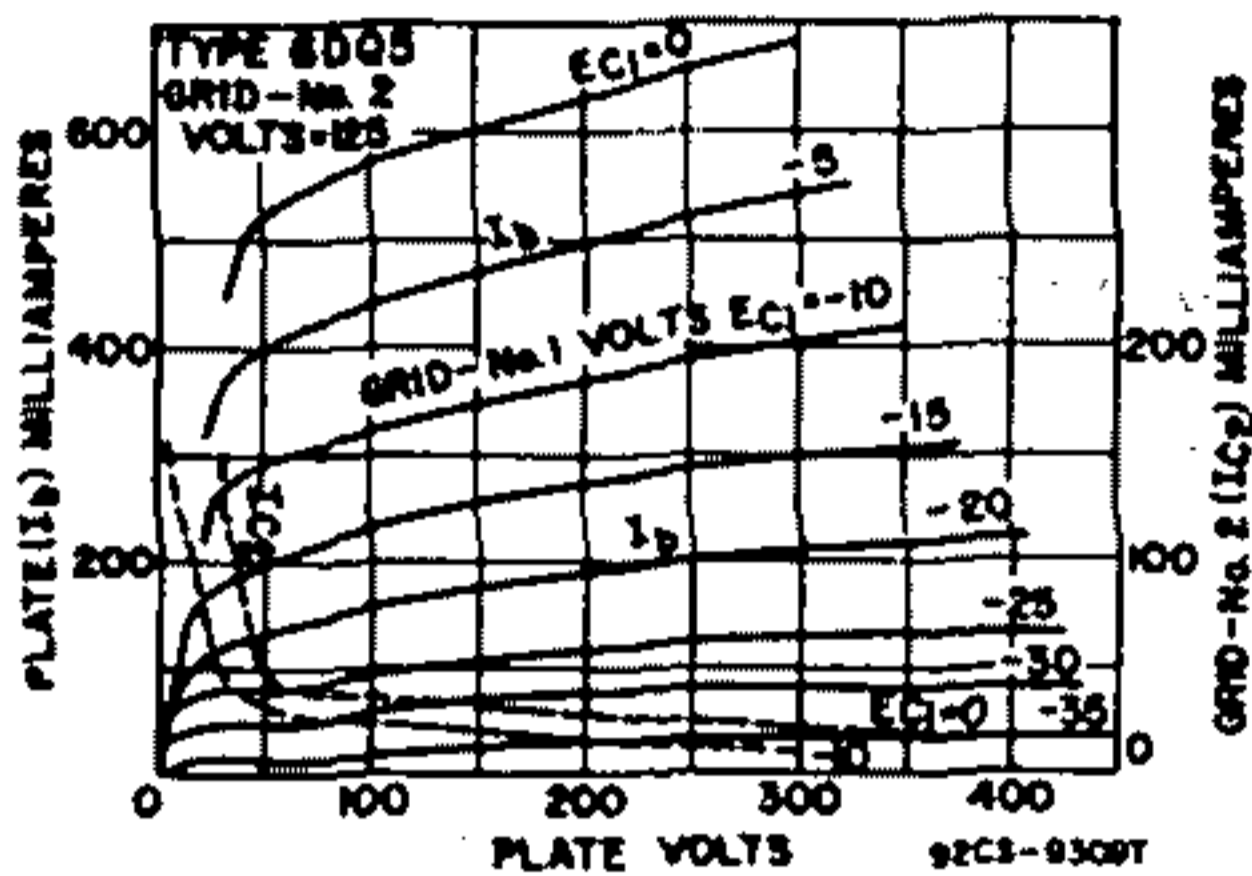
Plate Dissipation\* ..... 24 watts  
 Bulb Temperature (At hottest point) ..... 320 °C

**MAXIMUM CIRCUIT VALUE**

Grid-No.1-Circuit Resistance, For grid-resistor-bias operation .... 0.47 megohm

\* Pulse duration must not exceed 15% of a horizontal scanning cycle (10 microseconds).

\* A bias resistor or other means is required to protect the tube in absence of excitation.



Refer to chart at end of section.

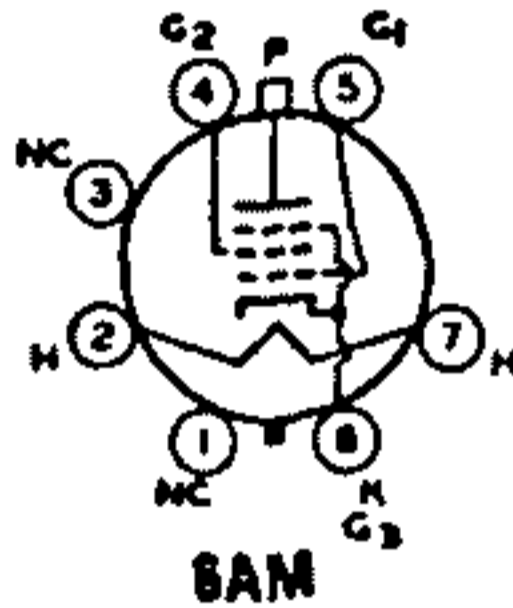
6DQ6A

**6DQ6B**

12DQ6B, 17DQ6B

**BEAM POWER TUBE**

Glass octal type used as horizontal-deflection-amplifier tube in high-efficiency deflection circuits of color and black-and-white television receivers. Outlines section, 20; requires octal socket. This type may be supplied with pin 1 omitted. Types 12DQ6B and 17DQ6B are identical with type 6DQ6B except for the heater ratings.



	6DQ6B	12DQ6B	17DQ6B	
Heater Voltage (ac/dc) .....	6.3	12.6	16.8	volts
Heater Current .....	1.2	0.6	0.45	ampere
Heater Warm-up Time (Average) .....	—	11	11	seconds
Heater-Cathode Voltage:				
Peak value .....	±200 max	±200 max	±200 max	volts
Average value .....	100 max	100 max	100 max	volts
Direct Interelectrode Capacitances (Approx.)				
Grid No.1 to Plate .....		0.5		pF
Grid No.1 to Cathode, Heater, Grid No.2, and Grid No.3 .....		15		pF
Plate to Cathode, Heater, Grid No.2, and Grid No.3 .....		7		pF

**Class A<sub>1</sub> Amplifier**

CHARACTERISTICS	60	250	
Plate Voltage .....	150	150	volts
Grid-No.2 Voltage .....	0	-22.5	volts
Grid-No.1 Voltage .....	—	18000	ohms
Plate Resistance (Approx.) .....	—	7300	μmhos
Transconductance .....	345*	65	mA
Plate Current .....	27*	1.8	mA
Grid-No.2 Current .....			
Grid-No.1 Voltage (Approx.) for			
grid-No.2 volts = 150, plate mA = 1,			
plate volts = 250 .....	—	-42	volts
plate volts = 5000 .....	—	-100	volts

**Horizontal-Deflection Amplifier**

Per operation in a 525-line, 30-frame system

**MAXIMUM RATINGS (Design-Maximum Values)**

DC Plate-Supply Voltage .....	770	volts
Peak Positive-Pulse Plate Voltage* .....	6500	volts
Peak Negative-Pulse Plate Voltage .....	-1500	volts



DC Grid-No.2 (Screen-Grid) Voltage .....	220	volts
Peak Negative-Pulse Grid-No.1 Voltage .....	-830	volts
Peak Cathode Current .....	610	mA
Average Cathode Current .....	175	mA
Grid-No.2 Input .....	3.6	watts
Plate Dissipation* .....	18	watts
Bulb Temperature (At hottest point) .....	220	°C

**MAXIMUM CIRCUIT VALUE**

Grid-No.1-Circuit Resistance for grid-resistor-bias operation .....	1	megohm
---	---	--------

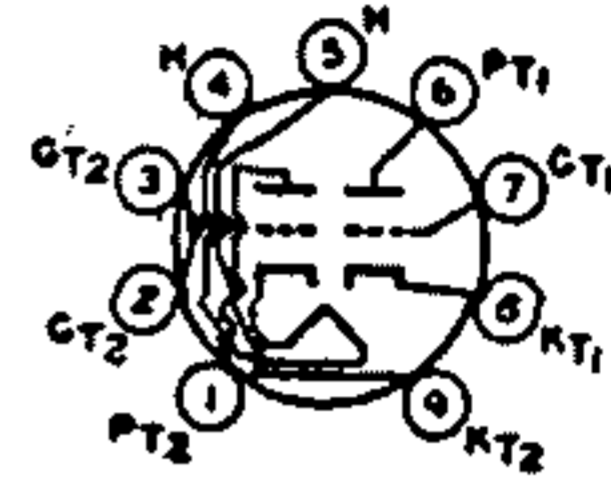
# Pulse duration must not exceed 15% of a horizontal scanning cycle (10 microseconds).  
 \* A bias resistor or other means is required to protect the tube in absence of excitation.

**6DR7**

10DR7, 13DR7

**DUAL TRIODE**

Miniature type containing high-mu and low-mu triodes; used as combined vertical-deflection-oscillator and vertical-deflection-amplifier tube in television receivers. Outlines section, 6E; requires miniature 9-contact socket. Types 10DR7 and 13DR7 are identical with type 6DR7 except for heater ratings.

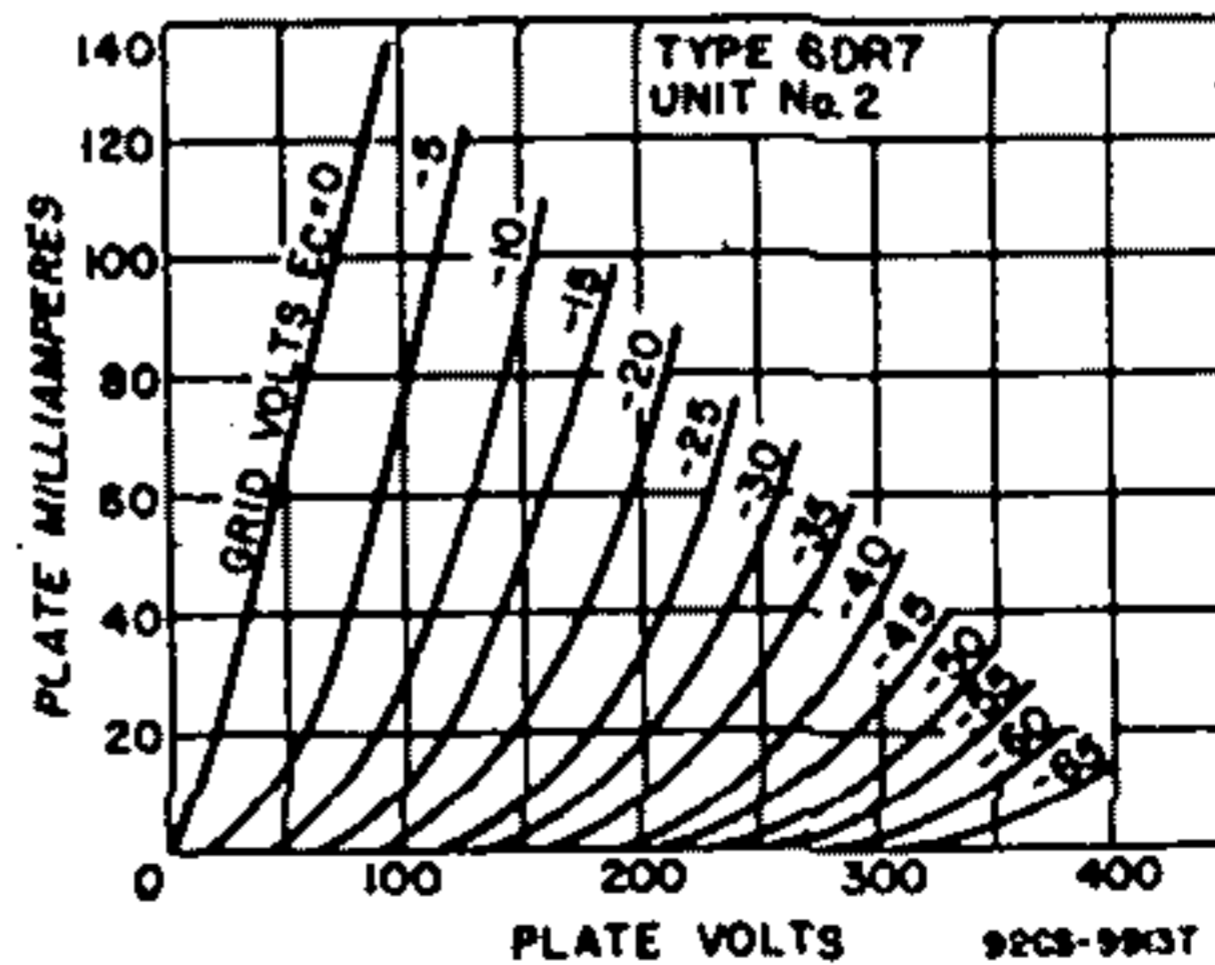
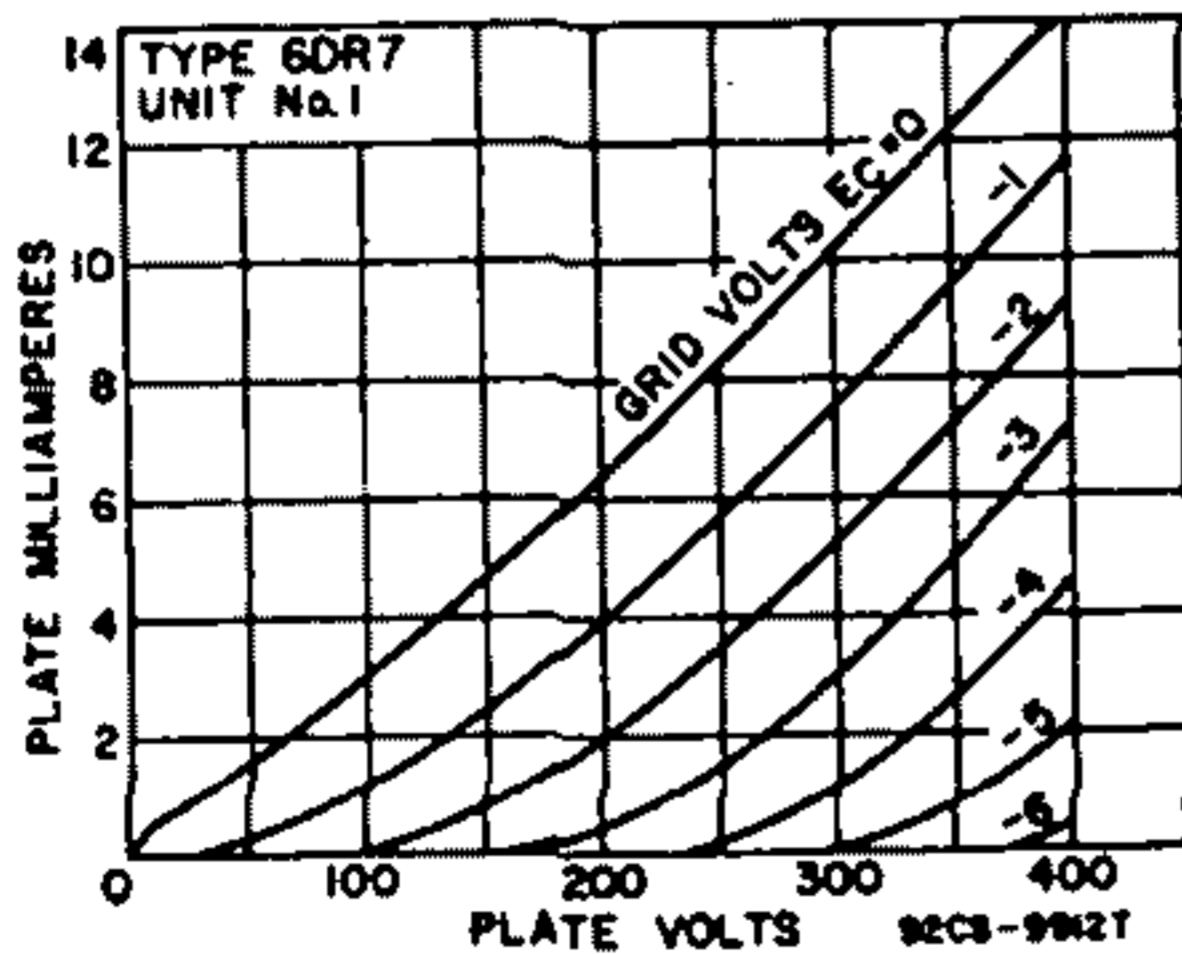


9HF

Heater Voltage (ac/dc) .....	6DR7	10DR7	13DR7	
Heater Current .....	6.3	9.7	13	volts
Heater Warm-up Time (Average) .....	0.9	0.6	0.45	ampere
Heater-Cathode Voltage:				seconds
Peak value .....	±200 max	±200 max	±200 max	volts
Average value .....	100 max	100 max	100 max	volts
Direct Interelectrode Capacitances (Approx.):		Unit No.1	Unit No.2	
Grid to Plate .....		4.5	8.5	pF
Grid to Cathode and Heater .....		2.2	5.5	pF
Plate to Cathode and Heater .....		0.34	1	pF

**Class A<sub>1</sub> Amplifier**

<b>CHARACTERISTICS</b>	Unit No.1	Unit No.2	
Plate Voltage .....	250	150	volts
Grid Voltage .....	-3	-17.5	volts
Amplification Factor .....	88	6	
Plate Resistance (Approx.) .....	40000	925	ohms
Transconductance .....	1600	6500	μmhos
Plate Current .....	1.4	35	mA
Plate Current for grid voltage of -24 volts .....	—	10	mA
Grid Voltage (Approx.) for plate current of 10 μA .....	-5.5	—	volts
Grid Voltage (Approx.) for plate current of 50 μA .....	—	-44	volts



**Vertical-Deflection Oscillator and Amplifier**

For operation in a 525-Line, 30-frame system

**MAXIMUM RATINGS (Design-Maximum Values)**

DC Plate Voltage .....	330	275	volts
Peak Positive-Pulse Plate Voltage# .....	—	1500	volts
Peak Negative-Pulse Grid Voltage .....	-400	-250	volts

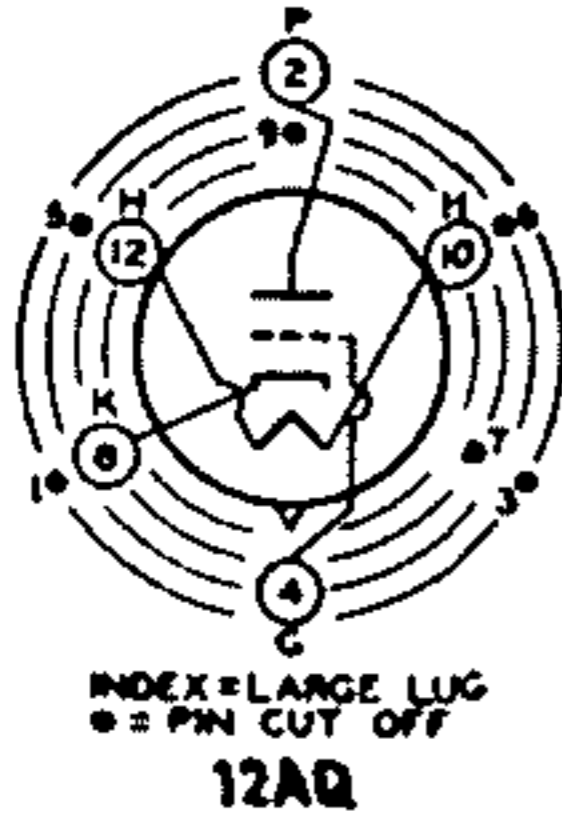
Peak Cathode Current .....	70	175	mA
Average Cathode Current .....	20	50	mA
Plate Dissipation .....	1	7	watts

**MAXIMUM CIRCUIT VALUES**

Grid-Circuit Resistance:

For grid-resistance-bias or cathode-bias operation	2.2	2.2	megohms
--	-----	-----	---------

\* Pulse duration must not exceed 15% of a vertical scanning cycle (2.5 milliseconds).



**HIGH-MU TRIODE**

Nuvistor type used as grounded-cathode, neutralized rf amplifier in vhf tuners of color and black-and-white television and FM receivers. Outlines section, 1; requires nuvistor socket. Type 2DS4 is identical with type 6DS4 except for heater ratings.

**6DS4**  
2DS4

Heater Voltage (ac/dc) .....	2.1	6.3	volts
Heater Current .....	0.45	1.35	amperes
Heater Warm-up Time (Average) .....	8	—	seconds
Peak Heater-Cathode Voltage .....	±100 max	±100 max	volts
Direct Interelectrode Capacitances (Approx.)			
Grid to Plate .....		0.92	pF
Grid to Cathode, Heater, and Shell .....		4.3	pF
Plate to Cathode, Heater, and Shell .....		1.8	pF
Plate to Cathode .....		0.18	pF
Heater to Cathode .....		1.6	pF

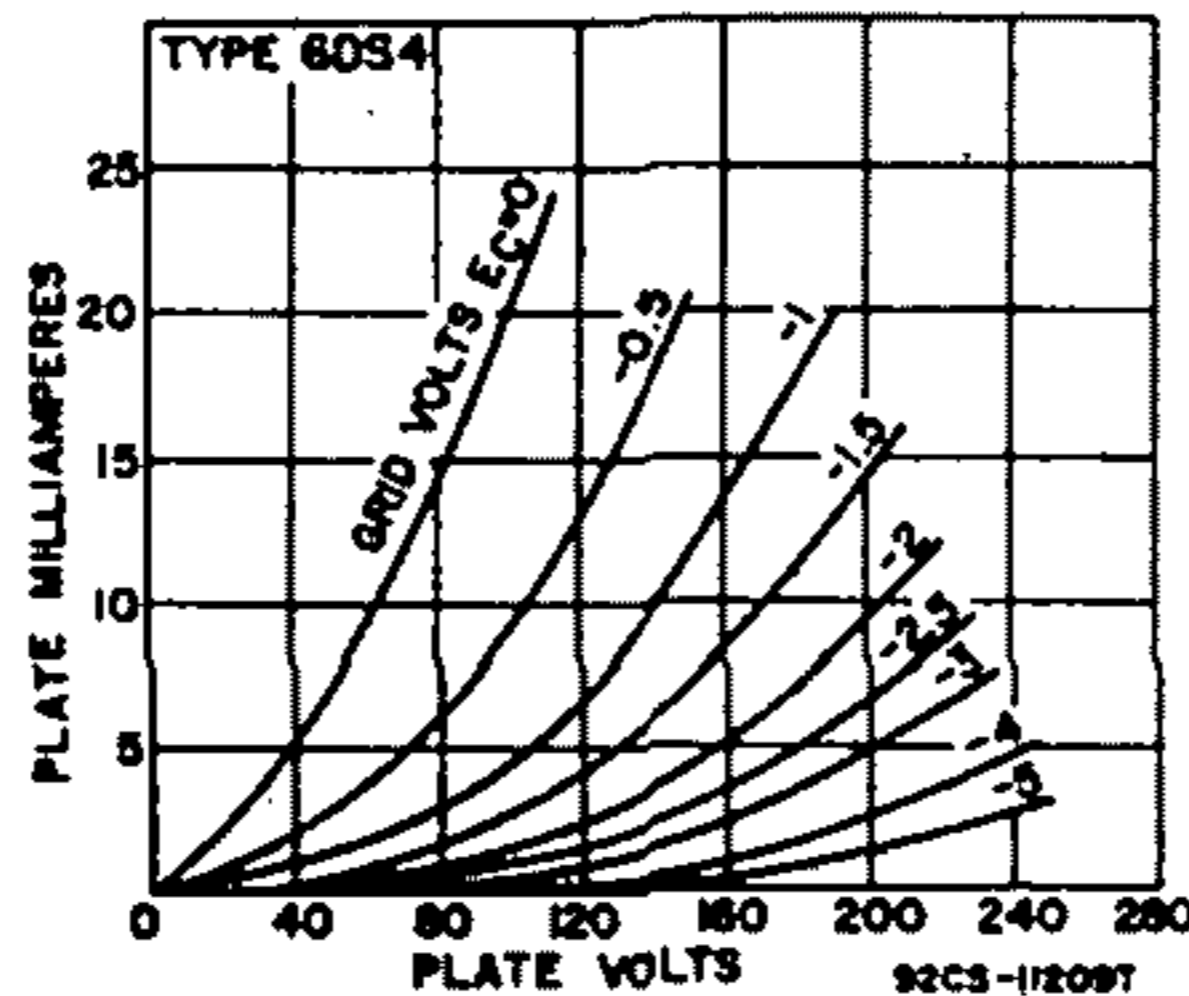
**Class A<sub>1</sub> Amplifier**

**MAXIMUM RATINGS (Design-Maximum Values)**

Plate Supply Voltage .....	300*	volts
Plate Voltage .....	135	volts
Grid Voltage, Negative-bias value .....	-55	volts
Grid Voltage, Peak positive value .....	0	volts
Cathode Current .....	15	mA
Plate Dissipation .....	1.5	watt

**CHARACTERISTICS**

Plate Supply Voltage .....	110	volts
Grid Supply Voltage .....	0	volts
Cathode-Bias Resistor .....	120	ohms
Amplification Factor .....	62	
Plate Resistance (Approx.) .....	7000	ohms
Transconductance .....	9000	μmhos
Plate Current .....	6.5	mA
Grid Voltage (Approx.) for plate current of 100 μA .....	-6	volts
Grid Voltage (Approx.) for plate current of 10 μA .....	-8.8	volts



**TYPICAL OPERATION**

Plate Voltage .....	70	volts
Grid Supply Voltage .....	0	volts
Grid Resistor .....	47000	ohms
Amplification Factor .....	68	
Plate Resistance (Approx.) .....	5440	ohms
Transconductance .....	12500	$\mu$ mbos
Plate Current .....	7	mA

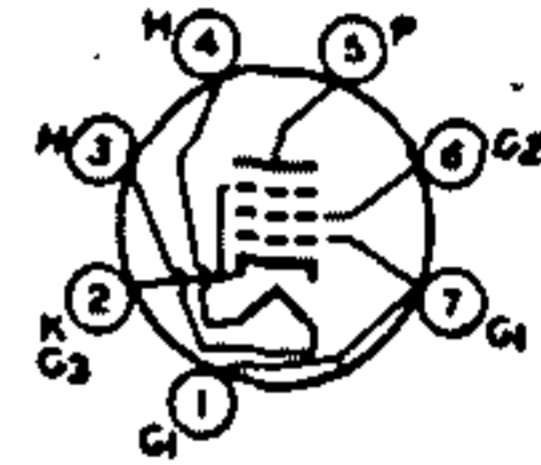
**MAXIMUM CIRCUIT VALUES**

Grid-Circuit Resistance:*		
For fixed-bias operation .....	0.5	megohm
For cathode-bias operation .....	2.2	megohm

\* A plate supply voltage of 300 volts may be used provided a sufficiently large resistor is used in the plate circuit to limit the plate dissipation to 1.5 watts under any condition of operation.  
 \* For operation at metal-shell temperatures up to 125°C.

**6DS5 BEAM POWER TUBE**

Miniature type used in the audio output stages of television and radio receivers. Outlines section, 5D; requires miniature 7-contact socket.



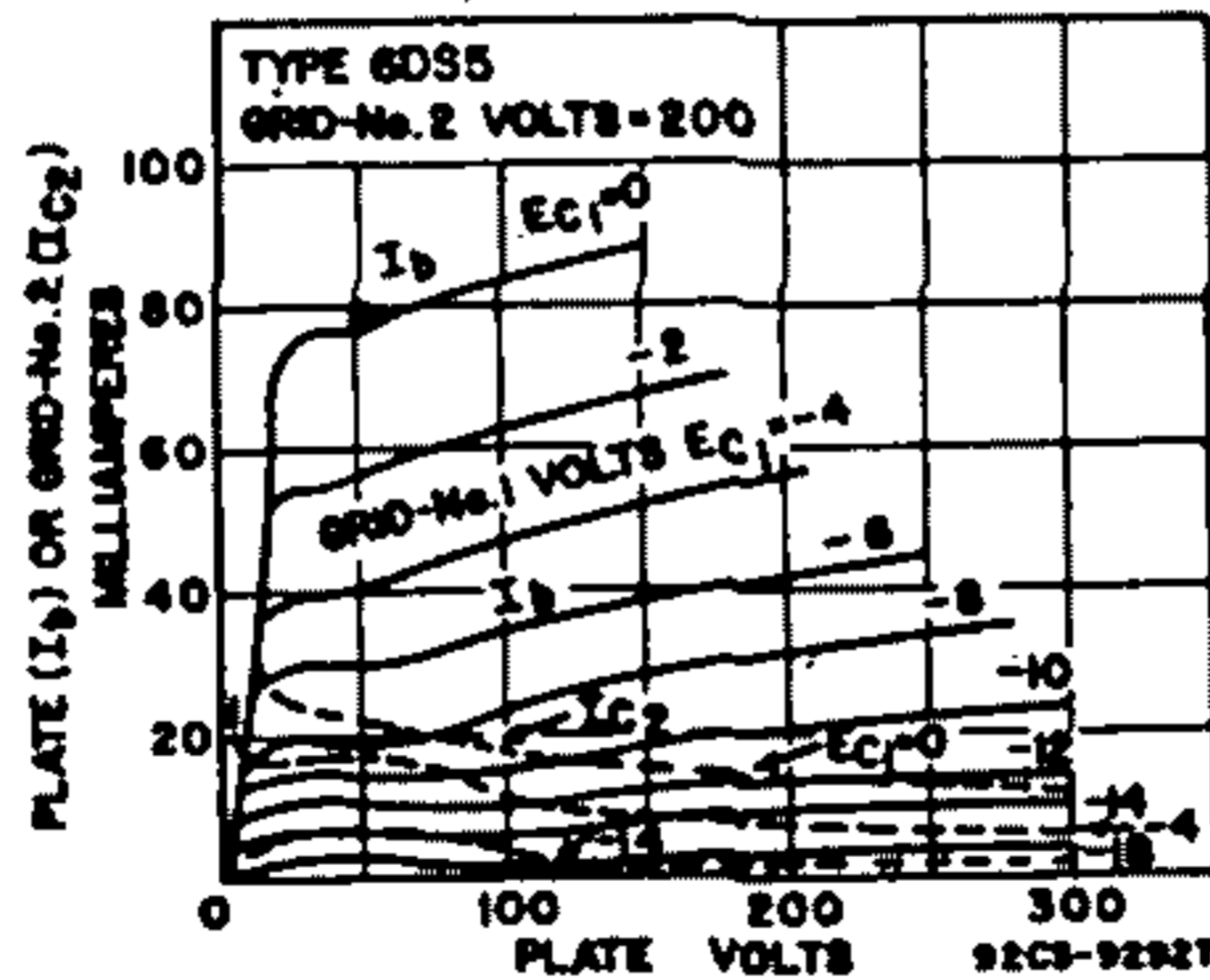
7BZ

Heater Voltage (ac/dc) .....	6.3	volts
Heater Current .....	0.8	ampere
Peak Heater-Cathode Voltage .....	$\pm 200$ max	volts
Direct Interelectrode Capacitances (Approx.):		
Grid No.1 to Plate .....	0.19	pF
Grid No.1 to Cathode, Heater, Grid No.2, and Grid No.3 .....	9.5	pF
Plate to Cathode, Heater, Grid No.2, and Grid No.3 .....	6.3	pF

**Class A<sub>1</sub> Amplifier**

**MAXIMUM RATINGS (Design-Maximum Values)**

Plate Voltage .....	275	volts
Grid-No.2 (Screen-Grid) Voltage .....	275	volts
Grid-No.1 (Control-Grid) Voltage, Positive-bias value .....	0	volts
Plate Dissipation .....	9	watts
Grid-No.2 Input .....	2.2	watts
Bulb Temperature (At hottest point) .....	250	°C



**TYPICAL OPERATION AND CHARACTERISTICS**

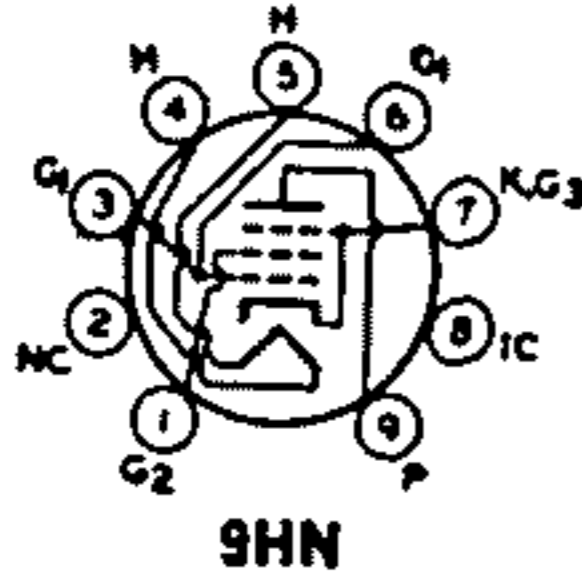
	Cathode-Bias Operation		Fixed-Bias Operation		
	200	250	200	250	
Plate Supply Voltage .....	200	250	200	250	volts
Grid-No.2 Supply Voltage .....	200	250	200	200	volts
Grid-No.1 Voltage .....	—	—	-7.5	-8.5	
Cathode-Bias Resistor .....	180	270	—	—	ohms
Peak AF Grid-No.1 Voltage .....	7.5	9.2	7.5	8.5	volts
Zero-Signal Plate Current .....	34.5	27	35	29	mA
Maximum-Signal Plate Current .....	32.5	25	36	32	mA
Zero-Signal Grid-No.2 Current .....	3.5	3	3	3	mA
Maximum-Signal Grid-No.2 Current .....	9	9	9	10	mA
Plate Resistance (Approx.) .....	28000	28000	28000	28000	ohms
Transconductance .....	6000	5800	6000	5800	$\mu$ mbos



	Cathode-Bias Operation		Fixed-Bias Operation		
	6000	8000	6000	8000	
Load Resistance .....					ohms
Total Harmonic Distortion .....	10	10	9	16	per cent
Maximum-Signal Power Output .....	2.8	3.6	3	3.8	watts

**MAXIMUM CIRCUIT VALUES**

Grid-No.1-Circuit Resistance:					
For fixed-bias operation .....			0.1		megohm
For cathode-bias operation .....			1.0		megohm



**BEAM POWER TUBE**

Miniature type used as a vertical-deflection-amplifier tube in television receivers employing 110-degree picture-tube systems. Outlines section, 6E; requires miniature 9-contact socket. Type 12DT5 is identical with type 6DT5 except for heater ratings.

**6DT5**

12DT5

	6DT5	12DT5	
Heater Voltage (ac/dc) .....	6.3	12.6	volts
Heater Current .....	1.2	0.6	amperes
Heater Warm-up Time (Average) .....	—	11	seconds
Heater-Cathode Voltage:			
Peak value .....	±200 max	±200 max	volts
Average value .....	100 max	100 max	volts

**Class A<sub>1</sub> Amplifier**

**CHARACTERISTICS**

Plate Voltage .....	60	80	250	volts
Grid-No. 2 Voltage .....	150	250	250	volts
Grid-No.1 Voltage .....	0	0	-16.5	volts
Transconductance .....	—	—	6200	μmhos
Plate Current .....	95*	196*	44	mA
Grid-No.2 Current .....	8.5*	19*	1.5	mA
Grid-No.1 Voltage (Approx.) for plate current of 100 mA .....	—	—	-35	volts

\* These values can be measured by a method involving a recurrent waveform such that the maximum ratings of the tube will not be exceeded.

**Vertical-Deflection Amplifier**

For operation in a 525-line, 30-frame system

**MAXIMUM RATINGS (Design-Maximum Values)**

DC Plate Voltage .....	315	volts
Peak Positive-Pulse Plate Voltage# .....	2200	volts
Grid-No.2 (Screen-Grid) Voltage .....	285	volts
Peak Negative-Pulse Grid-No.1 (Control-Grid) Voltage .....	-250	volts
Peak Cathode Current .....	190	mA
Average Cathode Current .....	55	mA
Plate Dissipation .....	9	watts
Grid-No.2 Input .....	2	watts

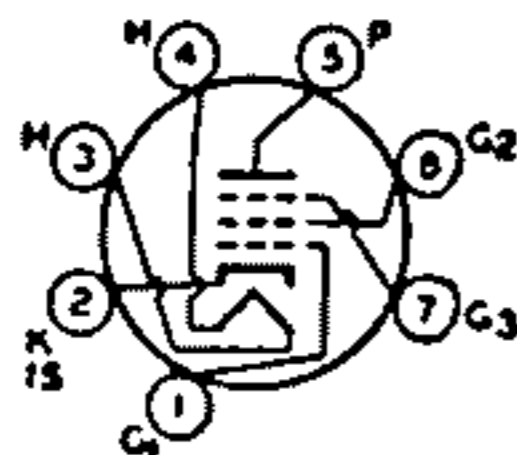
**MAXIMUM CIRCUIT VALUES**

Grid-No.1-Circuit Resistance:			
For fixed-bias operation .....	0.5		megohm
For cathode-bias operation .....	1		megohm

# Pulse duration must not exceed 15% of a vertical scanning cycle (2.5 milliseconds).

Refer to chart at end of section.

**6DT6**



**SHARP-CUTOFF PENTODE**

Miniature type used as FM detector in color and black-and-white television receivers. Outlines section, 5C; requires miniature 7-contact socket. Types 3DT6A and 4DT6A are identical with type 6DT6A except for heater ratings.

**6DT6A**

3DT6A, 4DT6A

	3DT6A	4DT6A	6DT6A	
Heater Voltage (ac/dc) .....	3.15	4.2	6.3	volts
Heater Current .....	0.8	0.45	0.3	ampere
Heater Warm-up Time (Average) .....	11	11	—	seconds
Heater-Cathode Voltage:				
Peak value .....	±200 max	±200 max	±200 max	volts
Average value .....	100 max	100 max	100 max	volts

Direct Interelectrode Capacitances (Approx.)*		
Grid No.1 to Plate .....	0.02	pF
Grid No.1 to Cathode, Heater, Grid No.2, Grid No.3, and Internal Shield .....	5.8	pF
Grid No.3 to Plate .....	1.7	pF
Grid No.1 to Grid No.3 .....	0.1	pF
Grid No.3 to Cathode, Heater, Grid No.1, Grid No.2, and Internal Shield .....	6.1	pF

\* External shield connected to cathode.

**Class A<sub>1</sub> Amplifier**

**CHARACTERISTICS**

Plate Supply Voltage .....	150	volts
Grid No.3 (Suppressor Grid) .....	Connected to cathode at socket	
Grid-No.2 (Screen-Grid) Supply Voltage .....	100	volts
Cathode-Bias Resistor .....	560	ohms
Plate Resistance (Approx.) .....	0.15	megohm
Transconductance, Grid No.1 to Plate .....	1350	μmhos
Transconductance, Grid No.3 to Plate .....	515	μmhos
Plate Current .....	1.55	mA
Grid-No.2 Current .....	1.8	mA
Grid-No.1 Voltage (Approx.) for plate current of 10 μA .....	-5.2	volts
Grid-No.3 Voltage (Approx.) for plate current of 10 μA .....	-4.2	volts

**FM Detector**

**MAXIMUM RATINGS (Design-Maximum Values)**

Plate Voltage .....	330	volts
Grid-No.3 Voltage .....	28	volts
Grid-No.2 Supply Voltage .....	330	volts
Grid-No.2 Voltage .....	See curve page 96	
Grid-No.1 (Control-Grid) Voltage, Positive-bias value .....	0	volts
Plate Dissipation .....	1.7	watts
Grid-No.2 Input:		
For grid-No.2 voltages up to 165 volts .....	1.1	watts
For grid-No.2 voltages between 165 and 330 volts .....	See curve page 96	

**MAXIMUM CIRCUIT VALUES**

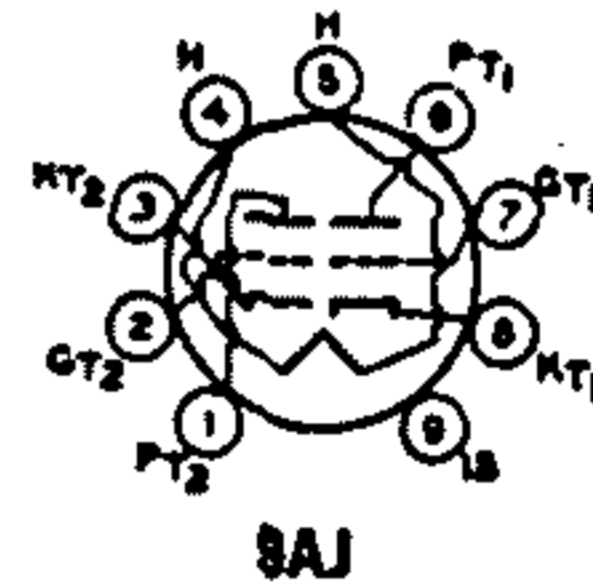
Grid-No.1-Circuit Resistance:		
For fixed-bias operation .....	0.25	megohm
For cathode-bias operation .....	0.5	megohm

**6DT8**

12DT8

**HIGH-MU TWIN TRIODE**

Miniature type used in radio and television receiver applications and in push-pull rf amplifiers or as frequency converter in FM tuners. Outlines section, 6B; requires miniature 9-contact socket. Type 12DT8 is identical with type 6DT8 except for the heater ratings. Except for heater and heater-cathode ratings, interelectrode capacitances, and basing arrangement, these types are identical with miniature type 12AT7.



	<b>6DT8</b>	<b>12DT8</b>	
Heater Voltage (ac/dc) .....	6.3	12.6	volts
Heater Current .....	0.8	0.15	ampere
Heater-Cathode Voltage:			
Peak value .....	±200 max	±200 max	volts
Average value .....	100 max	100 max	volts
Direct Interelectrode Capacitances (Approx., Each Unit Except as Noted:			
Grid to Plate .....	1.6*		pF
Grid to Cathode, Heater, and Internal Shield .....	2.7*		pF
Plate to Cathode, Heater, and Internal Shield .....	1.6*		pF
Heater to Cathode .....	3*		pF
Cathode to Grid, Heater, and Internal Shield (Unit No.2) .....	5.3†		pF
Plate to Grid, Heater, and Internal Shield (Unit No.2) .....	2.8†		pF

† With external shield connected to grid of unit under test.  
 \* With external shield connected to ground.  
 \* With external shield connected to cathode of unit under test.



INDEX - LARGE LUG  
 • - SHORT PIN

12EA

**HIGH-MU TRIODE**

**6DV4**

2DV4

Nuvistor type used at frequencies up to 1000 MHz in uhf oscillator stages of color and black-and-white television receivers. Outlines section, 1; requires nuvistor socket. Type 2DV4 is identical with type 6DV4 except for heater ratings.

	<b>2DV4</b>	<b>6DV4</b>	
Heater Voltage (ac/dc) .....	2.1	6.3	volts
Heater Current .....	0.45	0.135	ampere
Heater Warm-up Time (Average) .....	8	—	seconds
Peak Heater-Cathode Voltage .....	±100 max	±100 max	volts
<b>Direct Interelectrode Capacitance (Approx.):</b>			
Grid to Plate .....		1.8	pF
Grid to Cathode, Heater, and Shell .....		4.4	pF
Plate to Cathode, Heater, and Shell .....		1.9	pF
Plate to Cathode .....		0.25	pF
Heater to Cathode .....		1.4	pF
Grid to Cathode .....		8.7	pF

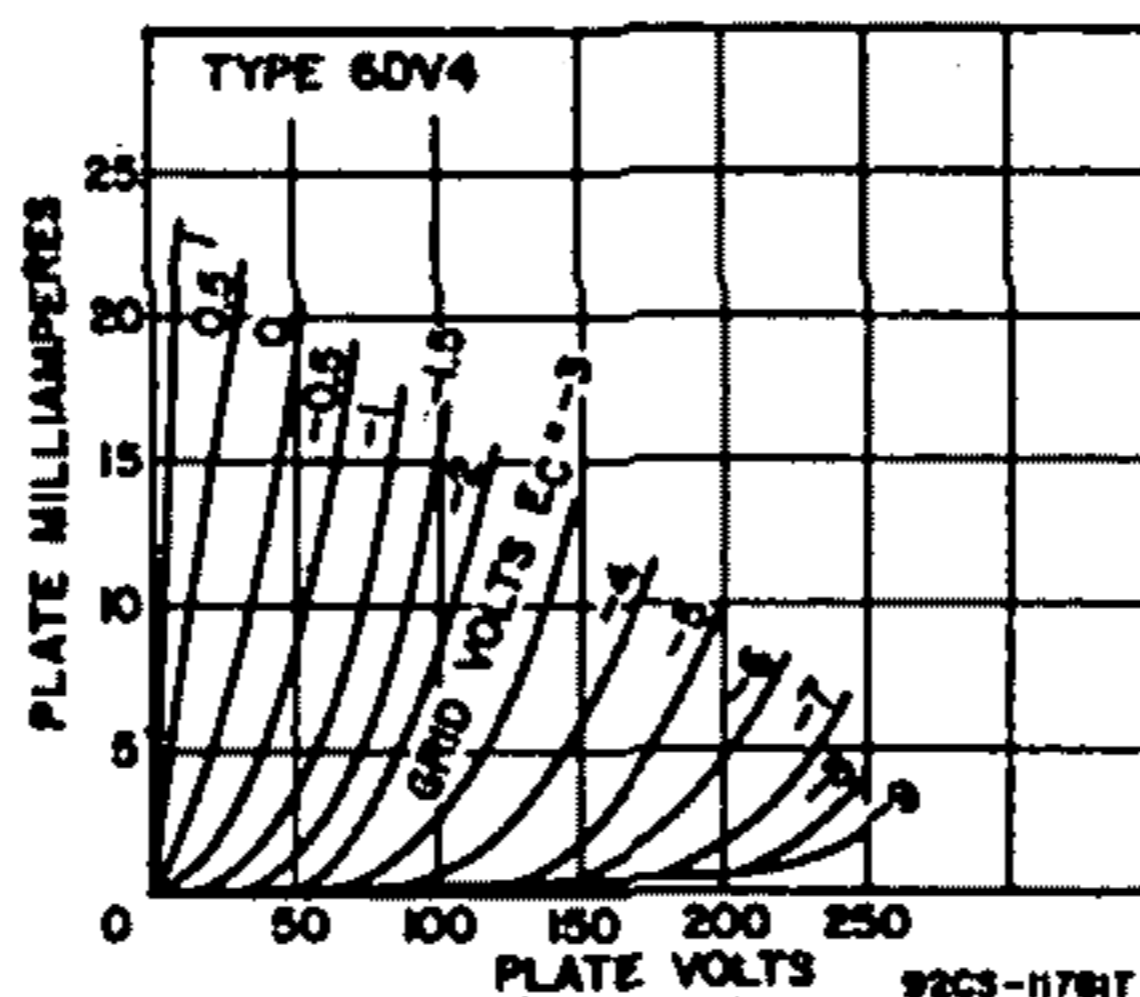
**Class A<sub>1</sub> Amplifier**

**MAXIMUM RATINGS (Design-Maximum Values)**

Plate Supply Voltage .....	300	volts
Plate Voltage .....	125	volts
Grid Voltage:		
Negative-bias value .....	-55	volts
Peak positive value .....	2	volts
Plate Dissipation .....	1	watt
Cathode Current .....	15	mA

**CHARACTERISTICS**

Plate Supply Voltage .....	75	volts
Cathode-Bias Resistor .....	100	ohms
Amplification Factor .....	36	
Plate Resistance (Approx.) .....	3100	ohms
Transconductance .....	11500	μmhos
Plate Current .....	10.6	mA
Grid Voltage (Approx.) for plate current of 10 μA .....	-7	volts



**TYPICAL OPERATION AS OSCILLATOR AT 950 MHz**

Plate Voltage .....	60	volts
Grid Voltage .....	-2	volts
Grid Resistor .....	5600	ohms
Plate Current .....	8	mA
Grid Current .....	350	μA



**MAXIMUM CIRCUIT VALUES**

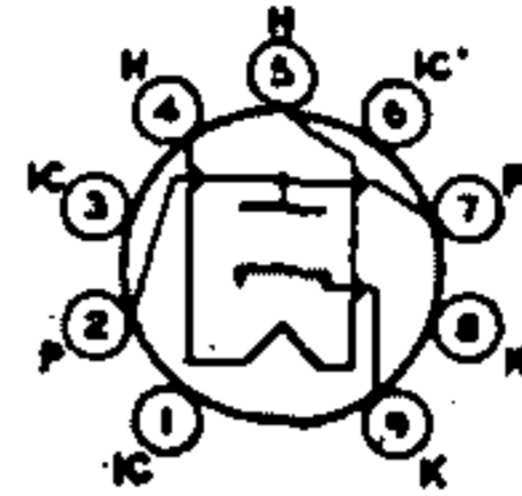
Grid-Circuit Resistance:*		
For fixed-bias operation .....	0.1	megohm
For cathode-bias operation .....	0.2	megohm

\* For operation at metal-shell temperatures up to 135°C.

**6DW4  
6DW4B**

**HALF-WAVE  
VACUUM RECTIFIER**

Novar types used as damper tubes in horizontal-deflection circuits of color and black-and-white television receivers. Outlines section, 11D and 30B, respectively; require novar 9-contact socket. Socket terminals 1, 3, 6, and 8 should not be used as tie points; it is recommended that socket clips for these pins be removed to reduce the possibility of arc-over and to minimize leakage. These tubes, like other power-handling tubes, should be adequately ventilated.



**9HP**

Heater Voltage (ac/dc) .....	6.3	volts
Heater Current .....	1.2	amperes
Direct Interelectrode Capacitances (Approx.):		
Plate to Cathode and Heater .....	6.5	pF
Cathode to Plate and Heater .....	9	pF
Heater to Cathode .....	2.8	pF

**Damper Service**

For operation in a 525-line, 30-frame system

**MAXIMUM RATINGS (Design-Maximum Values)**

Peak Inverse Plate Voltage# (6DW4) .....	5000	volts	
Peak Inverse Plate Voltage# (6DW4B) .....	5500	volts	
Peak Plate Current .....	1300	mA	
Average Plate Current .....	250	mA	
Plate Dissipation .....	8.5	watts	
Heater-Cathode Voltage:			
Peak value .....	+300	-5000	volts
Average value .....	+100	-900	volts

**CHARACTERISTICS, Instantaneous Value**

Tube Voltage Drop for plate current of 850 mA .....	25	volts
---	----	-------

# Pulse duration must not exceed 15% of a horizontal scanning cycle (10 microseconds).

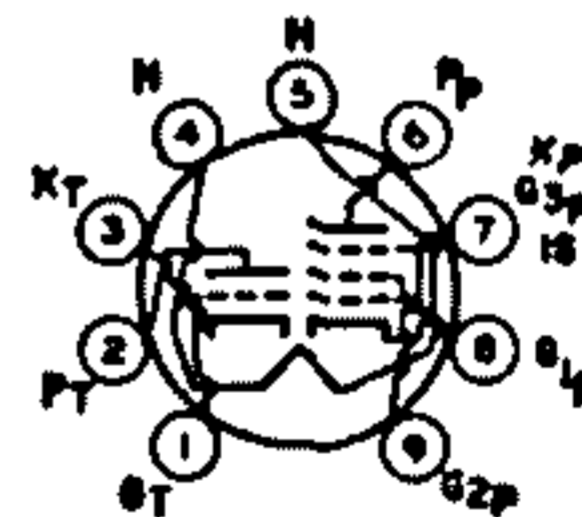
**6DW5**

See chart at end of section.

**6DX8  
6DX8/  
ECL84**

**HIGH-MU TRIODE—  
SHARP-CUTOFF PENTODE**

10DX8  
10DX8/LCL84



**9HX**

Miniature type used in color and black-and-white television-receiver applications. The triode unit is used as a sync-separator, sync-amplifier, keyed-agc, or noise-suppressor tube. The pentode unit is used as a video-output tube. Outlines section, 6E; requires miniature 9-contact socket. Type 10DX8 is identical with type 6DX8 except for heater ratings.

	<b>6DX8</b>	<b>10DX8</b>	
	<b>6DX8/ECL84</b>	<b>10DX8/LCL84</b>	
Heater Voltage (ac/dc) .....	6.3	10.2	volts
Heater Current .....	0.72	0.45	ampere
Peak Heater-Cathode Voltage .....	±200 max	±200 max	volts

**Class A<sub>1</sub> Amplifier**

**MAXIMUM RATINGS (Design-Center Values)**

	<b>Triode Unit</b>	<b>Pentode Unit</b>	
Plate Supply Voltage .....	550	550	volts
Peak Plate Voltage, with maximum plate current of 0.1 mA .....	600	—	volts

Plate Voltage .....	300	300	volts
Grid-No.2 (Screen-Grid) Supply Voltage .....	—	550	volts
Grid-No.2 Voltage .....	—	300	volts
Cathode Current .....	12	40	mA
Plate Dissipation .....	1	4	watts
Grid-No.2 Input .....	—	1.7	watts

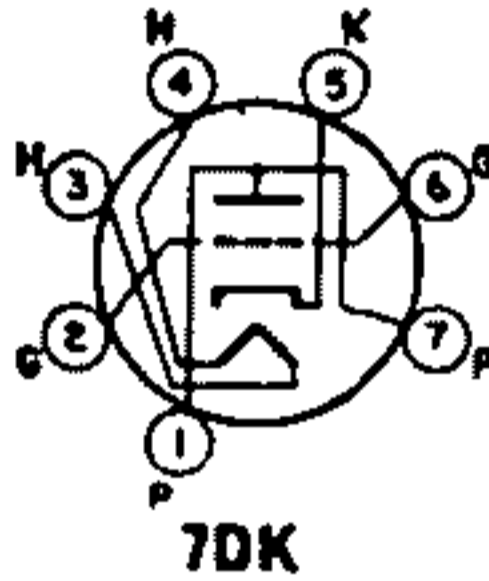
CHARACTERISTICS	Triode Unit		Pentode Unit		
Plate Voltage .....	200	170	200	220	volts
Grid-No.2 Voltage .....	—	170	200	220	volts
Grid No.1 Voltage .....	-1.7	-2.1	-2.9	-3.4	volts
Amplification Factor .....	55	—	—	—	
Mu-Factor, Grid-No.2 to Grid-No.1 .....	—	34	36	35	
Plate Resistance (Approx.) .....	—	0.1	0.13	0.15	megohm
Transconductance .....	4000	11000	10400	10000	μmhos
Plate Current .....	3	18	18	18	mA
Grid-No.2 Current .....	—	3	3	3	mA

MAXIMUM CIRCUIT VALUES	Triode Unit	Pentode Unit	
Grid-No.1- Circuit Resistance:			
For fixed-bias operation .....	1	1	megohm
For cathode-bias operation .....	3	2	megohms

\* With maximum duty factor of 0.18 and maximum pulse duration of 18 microseconds.

## 6DZ4

2DZ4, 3DZ4



### MEDIUM-MU TRIODE

Miniature type used as a local-oscillator tube in uhf color and black-and-white television receivers covering the frequency range from 470 to 890 MHz. Outlines section, 5B; requires miniature 7-contact socket. For curve of average plate characteristics, refer to type 6AF4A. Types 2DZ4 and 3DZ4 are identical with type 6DZ4 except for heater ratings.

	2DZ4	3DZ4	6DZ4	
Heater Voltage (ac/dc) .....	2.35	3.2	6.3	volts
Heater Current .....	0.6	0.45	0.225	ampere
Heater Warm-up Time (Average) .....	11	11	—	seconds
Heater-Cathode Voltage:				
Peak value .....	±180 max	±180 max	±50 max	volts
Average value .....	100 max	100 max	25 max	volts
Direct Interelectrode Capacitances (Approx.):*				
Grid to plate .....			1.8	pF
Grid to Cathode and Heater .....			2.2	pF
Plate to Cathode and Heater .....			1.3	pF

\* With external shield connected to cathode.

### Class A<sub>1</sub> Amplifier

CHARACTERISTICS		
Plate Supply Voltage .....	80	volts
Plate Resistor .....	2700	ohms
Amplification Factor .....	14	
Plate Resistance (Approx.) .....	2000	ohms
Transconductance .....	6700	μmhos
Plate Current .....	15	mA
Grid Voltage (Approx.) for plate current of 20 μA .....	-11	volts

### UHF Oscillator

MAXIMUM RATINGS (Design-Maximum Values)		
Plate Voltage .....	135	volts
Grid Voltage, Negative-bias value .....	-50	volts
Grid Current .....	2	mA
Cathode Current .....	20	mA
Plate Dissipation .....	2.3	watts
TYPICAL OPERATION AS OSCILLATOR AT 1000 MHz		
Plate Supply Voltage .....	135	volts
Plate-Circuit Resistance .....	2700	ohms
Grid Resistor .....	10000	ohms
Plate Current .....	15.5	mA
Grid Current (Approx.) .....	800	μA
MAXIMUM CIRCUIT VALUES		
Grid-Circuit Resistance:		
For fixed-bias operation .....	Not recommended	
For cathode-bias operation .....	0.5	megohm

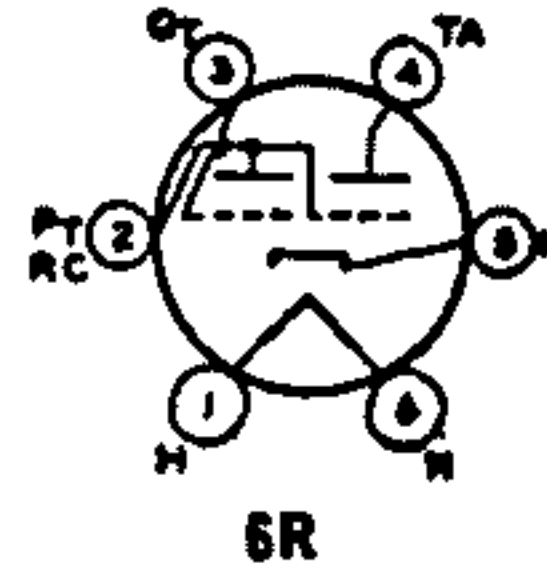
**6DZ7**

Refer to chart at end of section.

**6E5**

**ELECTRON-RAY TUBE**

Glass type used to indicate the effects of a change in a controlling voltage. It is used to indicate accurate radio-receiver tuning. Outlines section, 13H; requires 6-contact socket. Heater: volts (ac/dc), 6.3; amperes, 0.3. For additional considerations, refer to Tuning Indication with Electron-Ray Tubes in Electron Tube Applications section.



**Tuning Indicator**

**MAXIMUM AND MINIMUM RATINGS (Design-Center Values)**

Plate-Supply Voltage .....		250 max	volts
Target Voltage .....		{ 250 max	volts
		125 min	volts
<b>TYPICAL OPERATION</b>			
Plate and Target Supply Voltage .....	200	250	volts
Series Triode-Plate Resistor .....	1	1	megohm
Target Current*† .....	3	4	mA
Triode-Plate Current* .....	0.19	0.24	mA
Triode-Grid Voltage (Approx.):			
For shadow angle of 0° .....	-6.5	-8.0	volts
For shadow angle of 90° .....	0	0	volts

\* For zero triode-grid voltage.  
 † Subject to wide variations.

**6E6**

Refer to chart at end of section.

**6E7**

Refer to chart at end of section.

**6EA4**

**HIGH-MU TRIODE**

Duodecar type used as low-current, high-voltage beam triode as a shunt regulator in the high-voltage power supply of color television receivers. Outlines section, 10D; requires duodecar 12-contact socket. Heater: volts (ac/dc), 6.3; amperes, 0.2; maximum heater-cathode volts; +0, -200.

12FA

**Class A<sub>1</sub> Amplifier**

<b>MAXIMUM RATINGS (Design-Maximum Values)</b>			
DC Plate Voltage .....		60000	volts
Unregulated DC Supply Voltage .....		27000	volts
DC Grid Voltage .....		-135	volts
Peak Grid Voltage .....		-440	volts
Average Plate Current .....		1.6	mA
Plate Dissipation .....		30	watts
<b>MAXIMUM CIRCUIT VALUE</b>			
Grid-Circuit Resistance .....		3	megohms

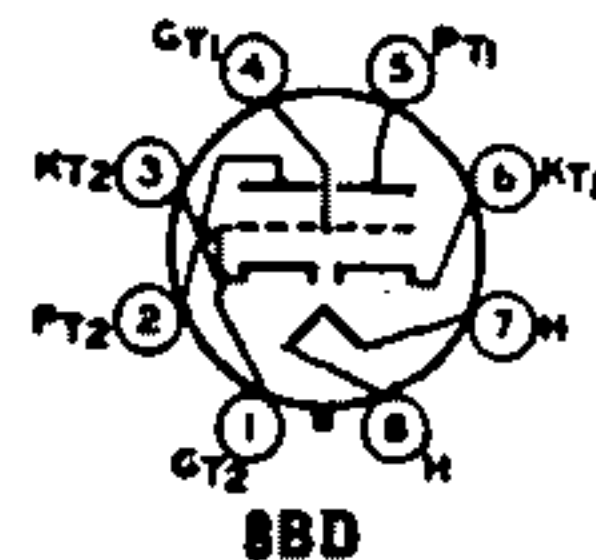
**6EA5**

Refer to chart at end of section.

**6EA7**

**DUAL TRIODE**

Glass octal type used as a combined vertical-deflection oscillator and vertical-deflection amplifier in television receivers. Outlines section, 13B; requires octal socket. Heater: volts (ac/dc), 6.3; amperes, 1.05; maximum heater-cathode volts, ±200 peak, 100 average.





**Class A<sub>1</sub> Amplifier**

CHARACTERISTICS	Unit No.1	Unit No.2		
Plate Voltage	250	60	175	volts
Grid Voltage	-3	0	-25	volts
Amplification Factor	66	—	5.5	
Plate Resistance (Approx.)	30000	—	920	ohms
Transconductance	2200	—	6000	μmhos
Plate Current	2	100*	40	mA
Grid Voltage (Approx.):				
For plate current of 20 μA	-5.3	—	—	volts
For plate current of 200 μA	—	—	-45	volts

\* This value can be measured by a method involving a recurrent waveform such that the maximum ratings of the tube will not be exceeded.

**Vertical-Deflection Oscillator and Amplifier**

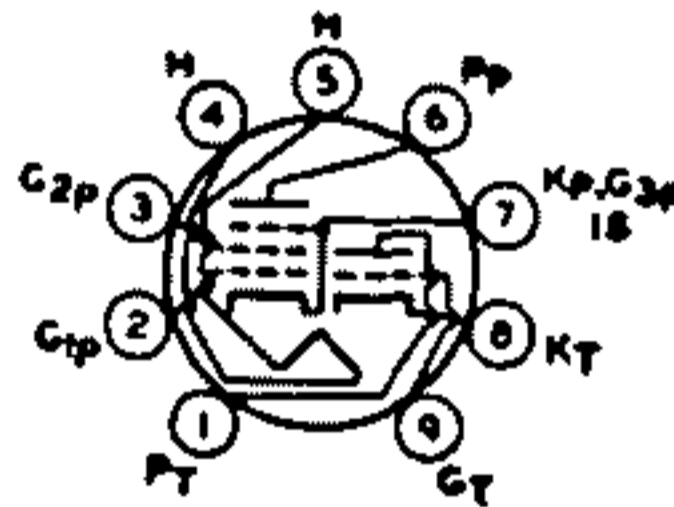
For operation in a 525-line, 30-frame system

MAXIMUM RATINGS (Design-Maximum Values)	Unit No.1 Oscillator	Unit No.2 Amplifier	
DC Plate Voltage	350	550	volts
Peak Positive-Pulse Plate Voltage#	—	1500	volts
Peak Negative-Pulse Grid Voltage	-400	-250	volts
Peak Cathode Current	—	175	mA
Average Cathode Current	—	50	mA
Plate Dissipation	1	10	watts

**MAXIMUM CIRCUIT VALUES**

Grid-Circuit Resistance:			
For grid-resistor-bias operation	1	1	megohm
For cathode-bias operation	2.2	2.2	megohms

# Pulse duration must not exceed 15% of a vertical scanning cycle (2.5 milliseconds).



8AE

**MEDIUM-MU TRIODE—SHARP-CUTOFF PENTODE 6EA8**

5EA8, 9EA8, 19EA8

Miniature type used as combined oscillator and mixer in color and black-and-white television receivers utilizing an intermediate frequency in the order of 40 MHz. Outlines section, 6B; requires miniature 9-contact socket. Types 5EA8, 9EA8, and 19EA8 are identical with type 6EA8 except for heater ratings.

	5EA8	6EA8	9EA8	19EA8	
Heater Voltage (ac/dc)	4.7	6.3	9.5	18.9	volts
Heater Current	0.6	0.45	0.15	0.15	ampere
Heater Warm-up Time (Average)	11	11	11	11	seconds
Heater-Cathode Voltage:					
Peak value	±200 max	±200 max	±200 max	±200 max	volts
Average value	100 max	100 max	100 max	100 max	volts

Unshielded    Shielded

Direct Interelectrode Capacitances:	Unshielded	Shielded	
Triode Unit:			
Grid to Plate	1.7	1.7	pF
Grid to Cathode, Heater, Pentode Cathode, Pentode Grid No.3, and Internal Shield	3	3.2	pF
Plate to Cathode, Heater, Pentode Cathode, Pentode Grid No.3, and Internal Shield	1.4	1.9	pF
Cathode to Heater	3	3*	pF
Pentode Unit:			
Grid No.1 to Plate	0.02 max	0.01 max	pF
Grid No.1 to Cathode, Heater, Grid No.2, Grid No.3, and Internal Shield	5	5	pF
Plate to Cathode, Heater, Grid No.2, Grid No.3, and Internal Shield	2.6	3.4	pF
Heater to Cathode	3	3*	pF

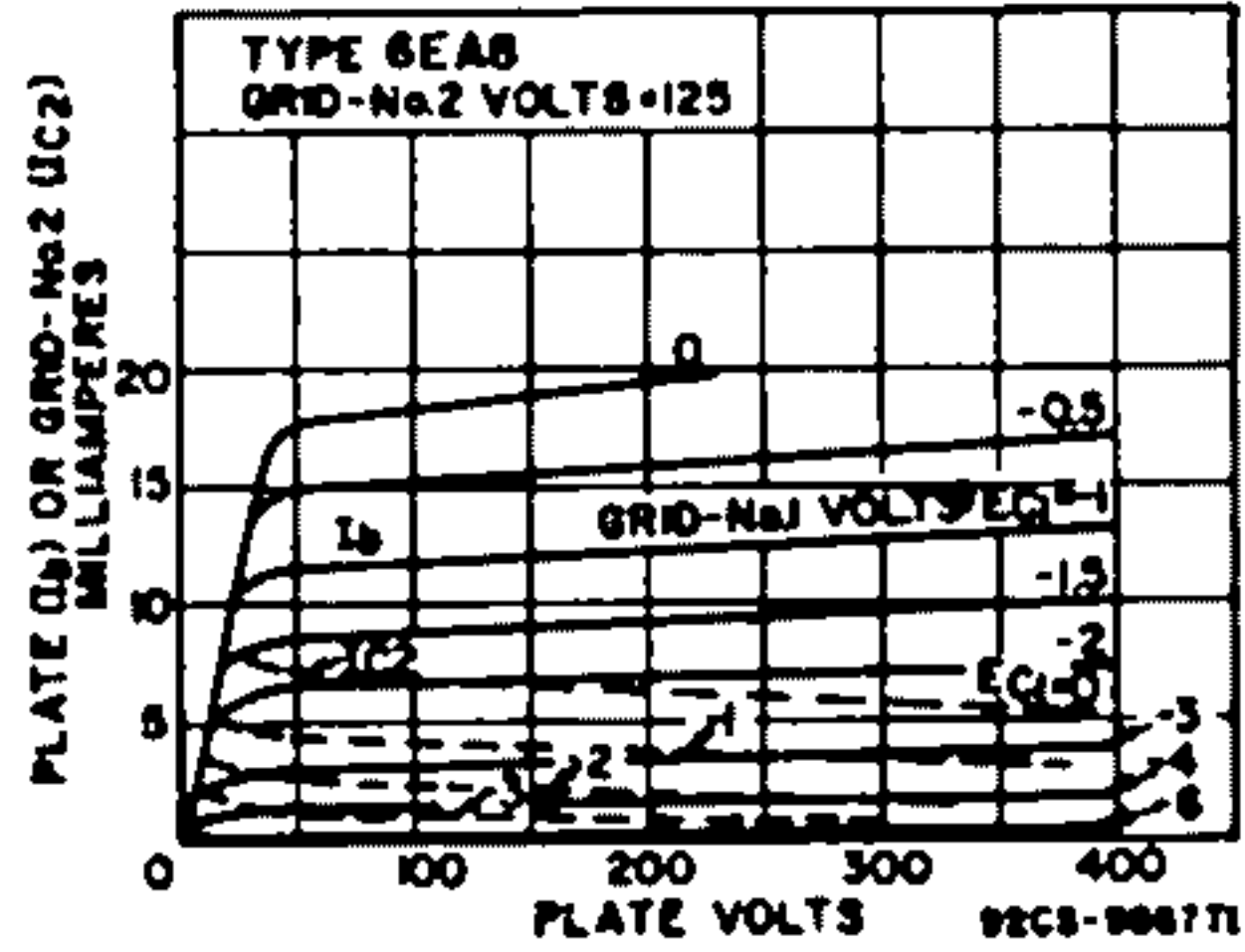
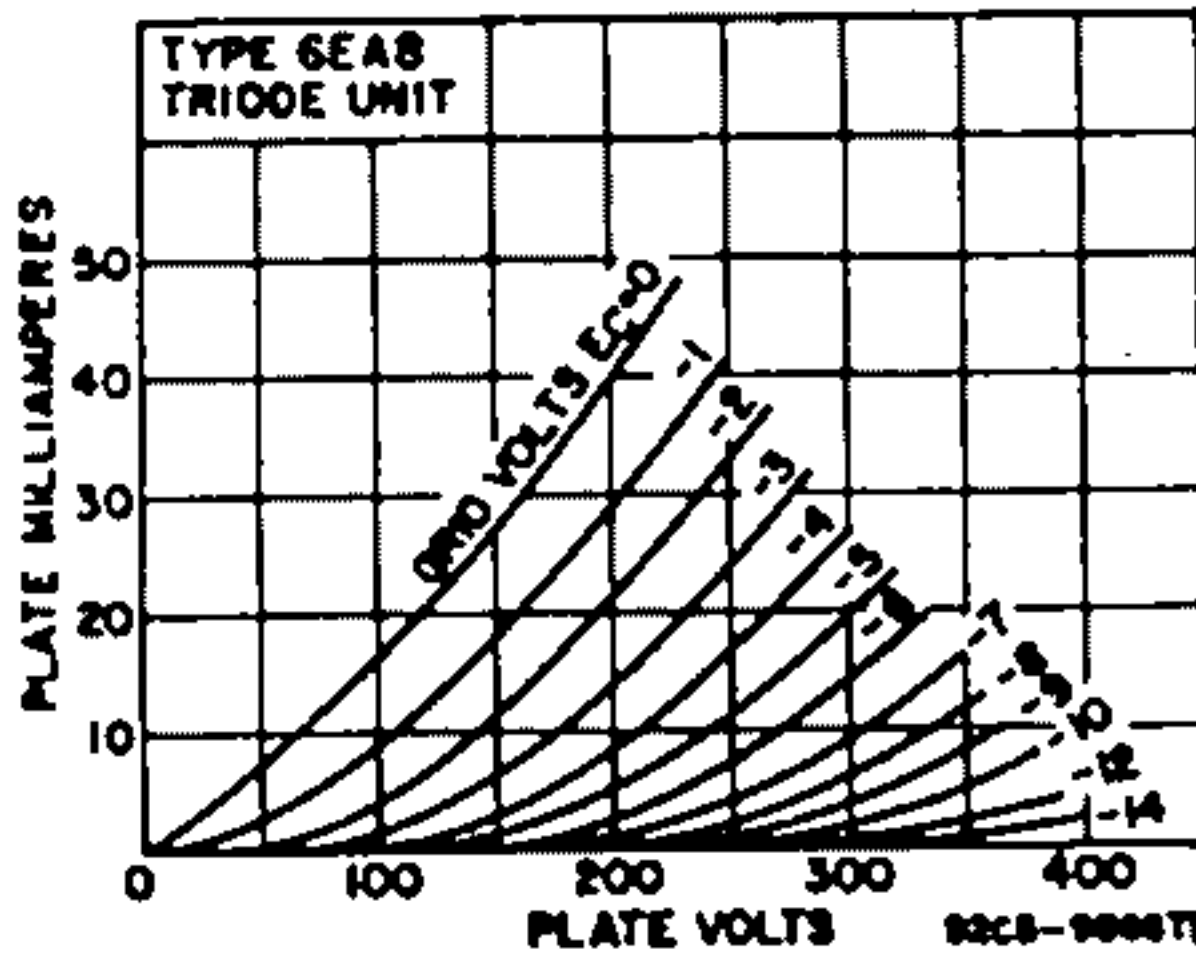
\* With external shield connected to cathode of unit under test except as noted.

\* With external shield connected to ground.

**Class A<sub>1</sub> Amplifier**

MAXIMUM RATINGS (Design-Maximum Values)	Triode Unit	Pentode Unit	
Plate Voltage	330	330	volts
Grid-No.2 (Screen-Grid) Supply Voltage	—	330	volts
Grid-No.2 Voltage	—	See curve page 96	
Grid-No.1 (Control-Grid) Voltage, Positive-bias value	0	0	volts

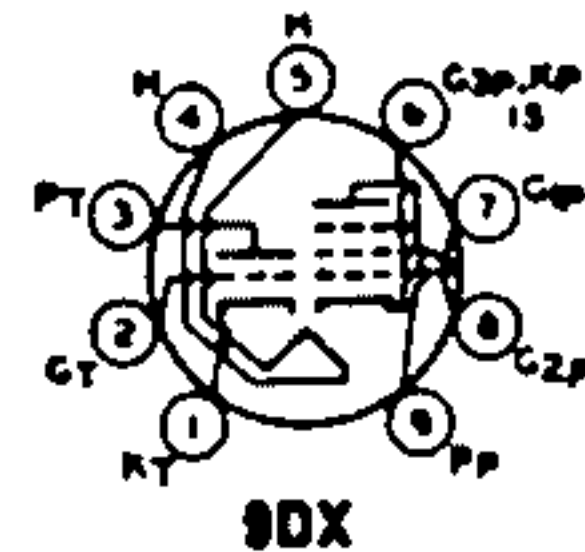
Plate Dissipation .....	2.5	3.1	watts
Grid-No.2 Input:			
For grid-No.2 voltages up to 165 volts .....	—	0.55	watt
For grid-No.2 voltages between 165 and 230 volts .....	—	See curve page 96	
<b>CHARACTERISTICS</b>			
Plate Supply Voltage .....	150	125	volts
Grid-No.2 Voltage .....	—	125	volts
Grid-No.1 Voltage .....	—	-1	volt
Cathode-Bias Resistor .....	66	—	ohms
Amplification Factor .....	40	—	
Plate Resistance (Approx.) .....	5000	200000	ohms
Transconductance .....	8500	6400	μmhos
Plate Current .....	18	12	mA
Grid-No.2 Current .....	—	4	mA
Grid-No.1 Voltage for plate current of 10 μA .....	-12	-9	volts



# 6E8B

## HIGH-MU TRIODE— SHARP-CUTOFF PENTODE

Miniature type used in color and black-and-white television receiver applications. Pentode unit is used as video output amplifier; triode unit is used in sync-separator, sync-clipper, and phase-inverter circuits. Outlines section, 6E; requires miniature 9-contact socket. Type 8E8B is identical with type 6E8B except for heater ratings.



Heater Voltage (ac/dc) .....	6.3	8	volts
Heater Current .....	0.75	0.8	ampere
Heater Warm-up Time (Average) .....	—	11	seconds
Heater-Cathode Voltage:			
Peak value .....	±200 max	±200 max	volts
Average value .....	100 max	100 max	volts
Direct Interelectrode Capacitances:			
Triode Unit:			
Grid to Plate .....		4.4	pF
Grid to Cathode and Heater .....		2.4	pF
Plate to Cathode and Heater .....		0.86	pF
Pentode Unit:			
Grid No.1 to Plate .....		0.1 max	pF
Grid No.1 to Cathode, Heater, Grid No.2, Grid No.3, and Internal Shield .....		11	pF
Plate to Cathode, Heater, Grid No.2, Grid No.3, and Internal Shield .....		4.2	pF
Triode Grid to Pentode Plate .....		0.018 max	pF
Pentode Grid No.1 to Triode Plate .....		0.005 max	pF
Pentode Plate to Triode Plate .....		0.17 max	pF

### Class A<sub>1</sub> Amplifier

<b>MAXIMUM RATINGS (Design-Maximum Values)</b>	<b>Triode Unit</b>	<b>Pentode Unit</b>	
Plate Voltage .....	230	230	volts
Grid-No.2 (Screen-Grid) Supply Voltage .....	—	330	volts
Grid-No.2 Voltage .....	—	See curve page 96	
Grid-No.1 (Control-Grid) Voltage, Positive-bias value .....	0	0	volts
Plate Dissipation .....	1	5	watts

Grid-No.2 Input:  
 For grid-No.2 voltages up to 165 volts ..... — 1.1 watts  
 For grid-No.2 voltages between 165 and 330 volts ..... — See curve page 96

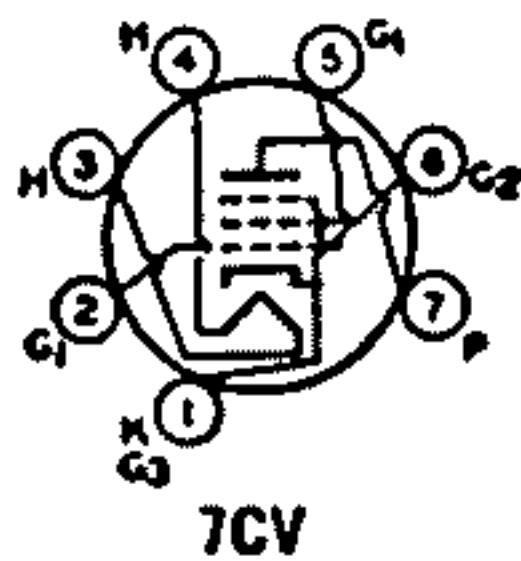
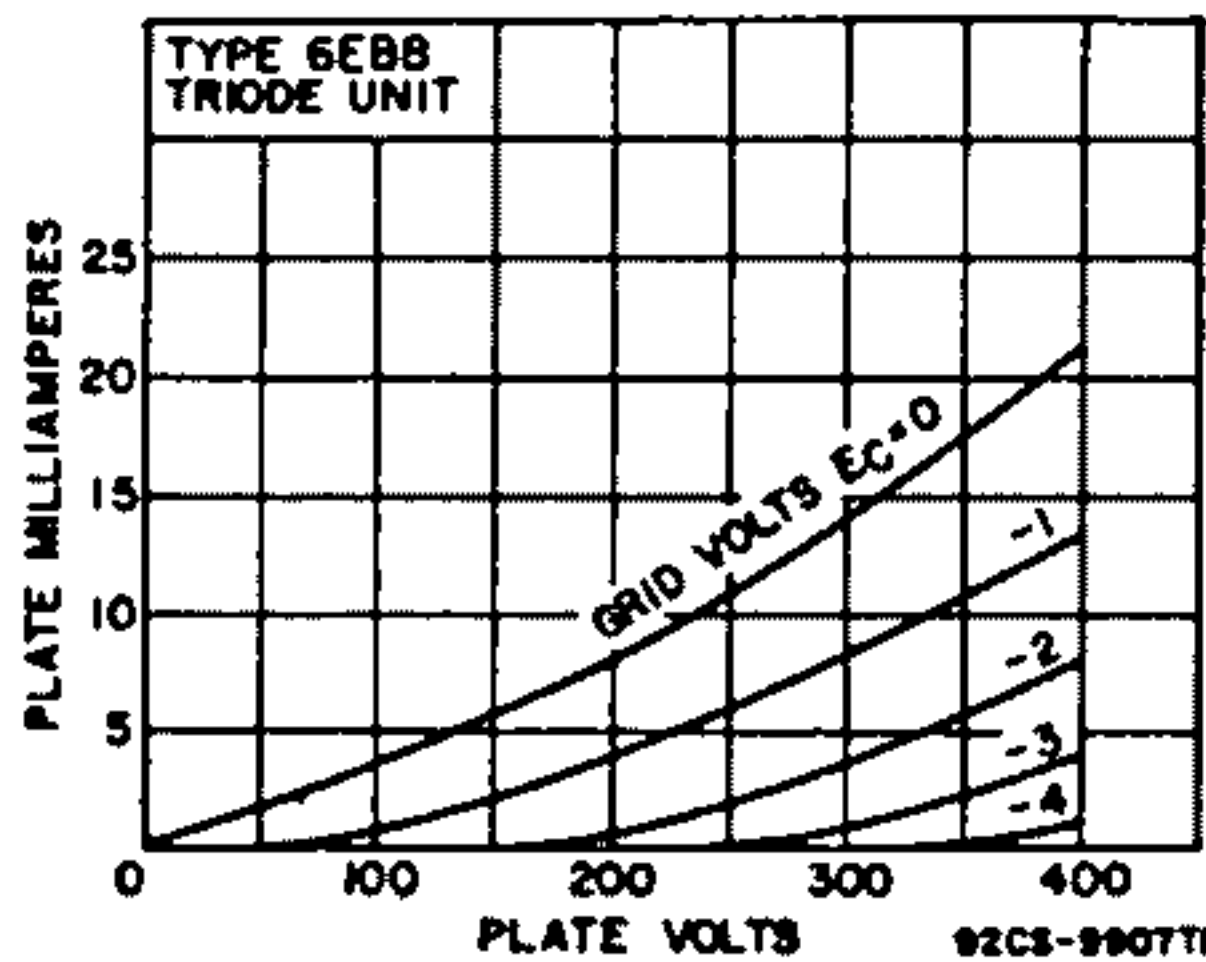
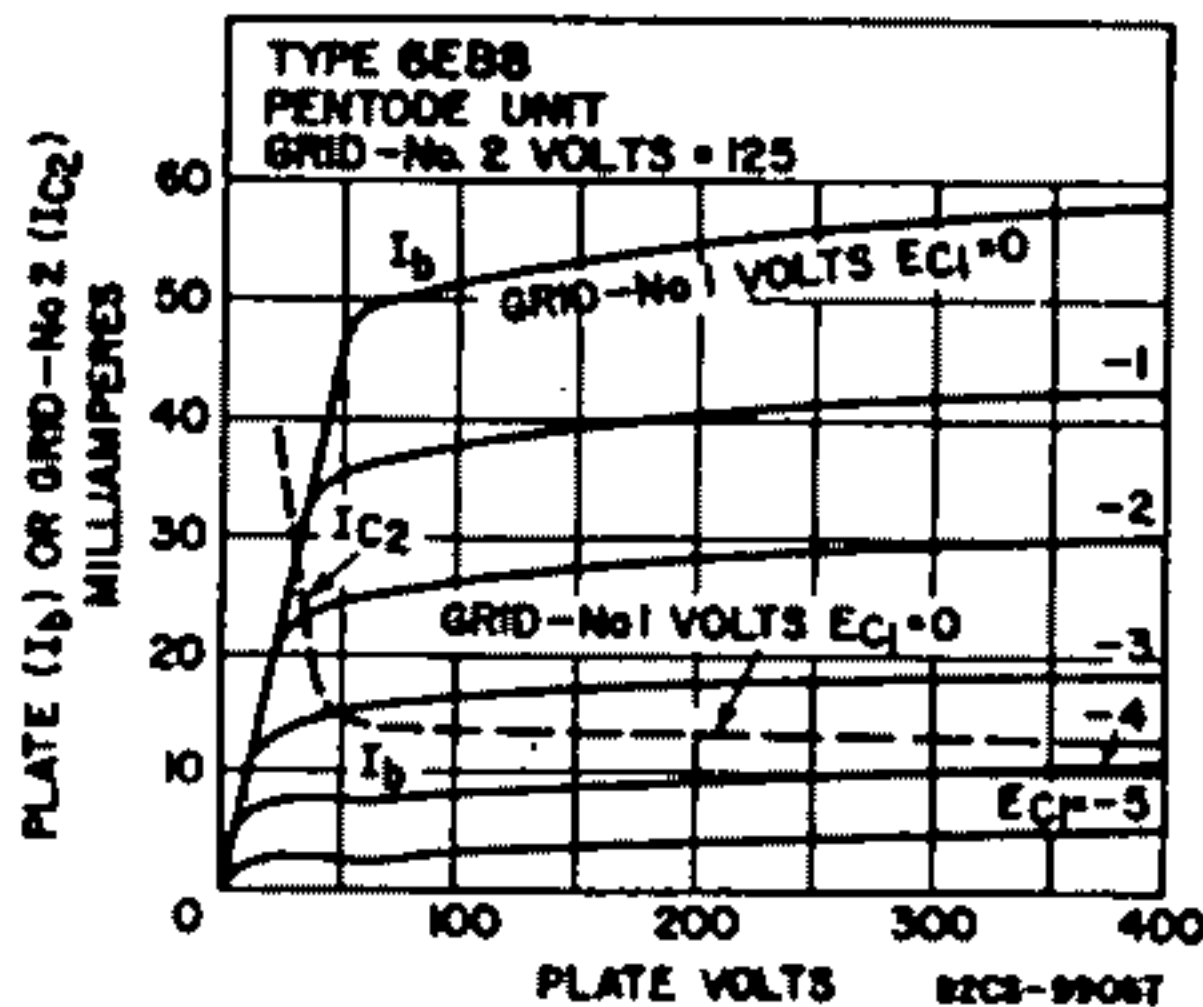
**CHARACTERISTICS**

Plate Supply Voltage	250	200	volts
Grid-No.2 Supply Voltage	—	125	volts
Grid Voltage	—2	—	volts
Cathode-Bias Resistor	—	68	ohms
Amplification Factor	100	—	
Plate Resistance (Approx.)	37000	75000	ohms
Transconductance	2700	12500	μmhos
Plate Current	2	25	mA
Grid-No.2 Current	—	7	mA
Grid Voltage (Approx.) for plate current of 20 μA	—5	—	volts
Grid-No.1 Voltage (Approx.) for plate current of 100 μA	—	—9	volts

**MAXIMUM CIRCUIT VALUES**

Grid-No.1-Circuit Resistance:

For fixed-bias operation	0.5	0.25	megohm
For cathode-bias operation	1.0	1.0	megohm



**POWER PENTODE**

**6EH5**

12EH5, 25EH5, 50EH5

Miniature type used in the audio output stage of radio and television receivers and in phonographs. Outlines section, 5D; requires miniature 7-contact socket. Types 12EH5, 25EH5, and 50EH5 are identical with type 6EH5 except for heater ratings.

	6EH5	12EH5	25EH5	50EH5	
Heater Voltage (ac/dc)	6.3	12.6	25	50	volts
Heater Current	1.2	0.6	0.3	0.15	amperes
Heater Warm-up Time (Average)	—	11	—	—	seconds
Heater-Cathode Voltage:					
Peak value	±200 max				volts
Average value	100 max				volts
Direct Interelectrode Capacitances (Approx.):					
Grid No.1 to Plate	0.65				pF
Grid No.1 to Cathode, Heater, Grid No.2, and Grid No.3	17				pF
Plate to Cathode, Heater, Grid No.2, and Grid No.3	9				pF

**Class A<sub>1</sub> Amplifier**

**MAXIMUM RATINGS (Design-Maximum Values)**

Plate Voltage	150	volts
Grid-No.2 (Screen-Grid) Voltage	130	volts
Plate Dissipation	5.5	watts
Grid-No.2 Input	2	watts
Bulb Temperature (at hottest point)	220	°C

**TYPICAL OPERATION**

Plate Supply Voltage	110	volts
Grid-No.2 Supply Voltage	115	volts
Cathode-Bias Resistor	68	ohms



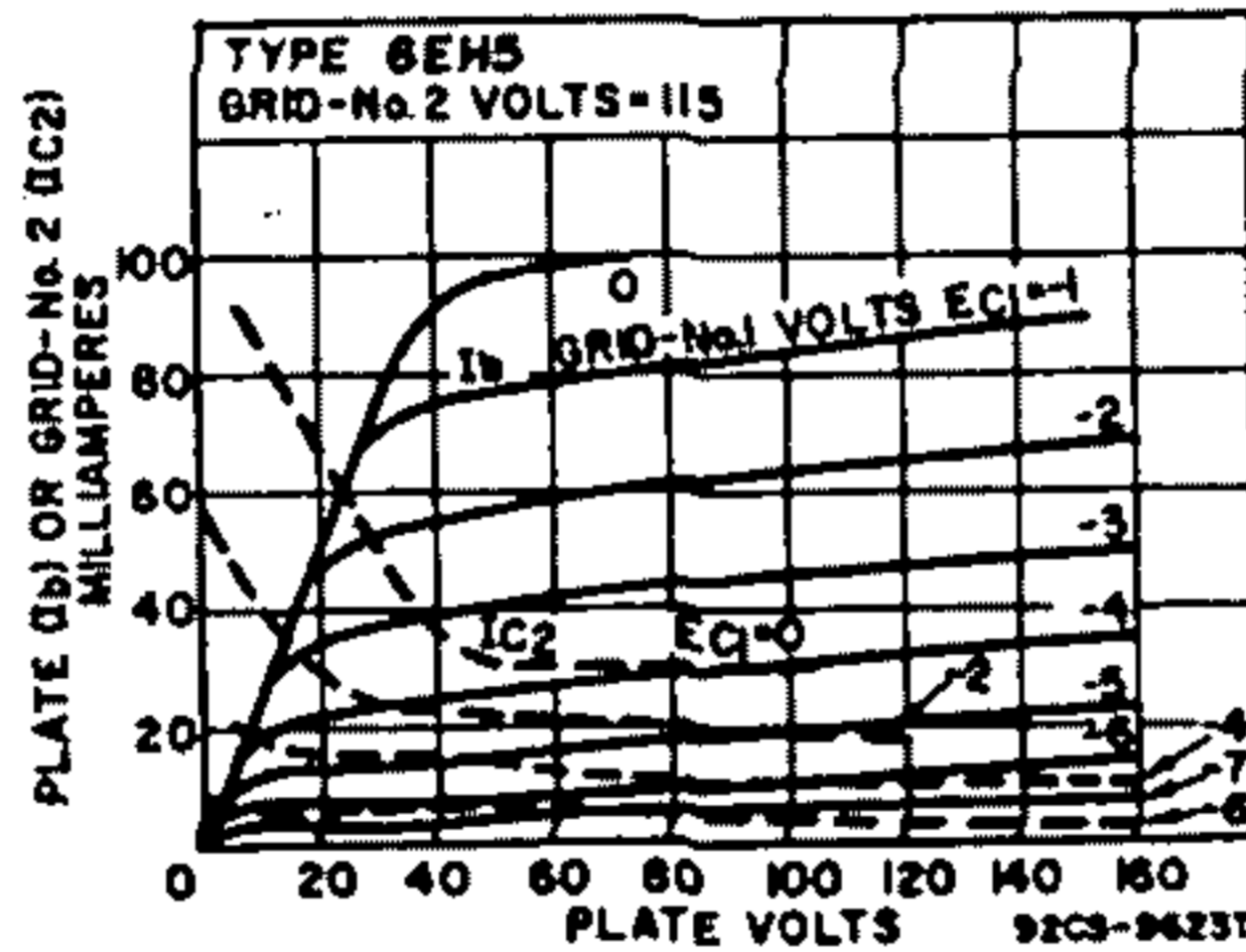
Peak AF Grid-No.1 Voltage .....	3	volts
Zero-Signal Plate Current .....	42	mA
Maximum-Signal Plate Current .....	42	mA
Zero-Signal Grid-No.2 Current .....	11.5	mA
Maximum-Signal Grid-No.2 Current .....	14.5	mA
Plate Resistance (Approx.) .....	11000	ohms
Transconductance .....	24800	$\mu$ mbos
Load Resistance .....	3000	ohms
Total Harmonic Distortion .....	7	per cent
Maximum-Signal Power Output .....	1.4	watts
<b>MAXIMUM CIRCUIT VALUES</b>		
Grid-No.1-Circuit Resistance:		
For fixed-bias operation .....	0.1	megohm
For cathode-bias operation .....	0.5	megohm

**Push-Pull Class AB<sub>1</sub> Audio-Frequency Power Amplifier**

MAXIMUM RATINGS (Same as for Class A<sub>1</sub> audio-frequency power amplifier)

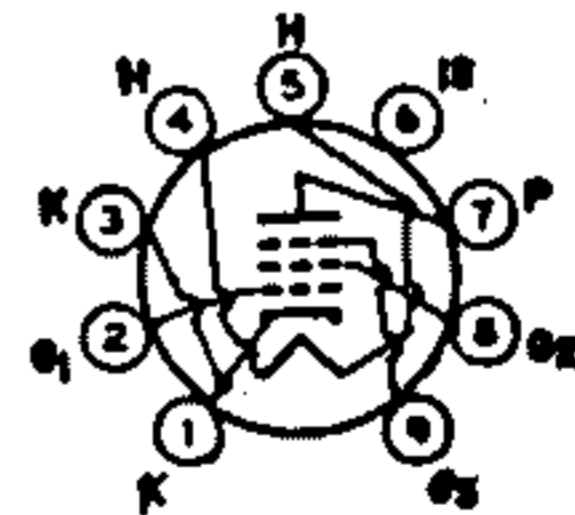
TYPICAL OPERATION (Values are for two tubes)

Plate Supply Voltage .....	140	volts
Grid-No.2 Supply Voltage .....	120	volts
Cathode-Bias Resistor .....	68	ohms
Peak AF Grid-No.1 Voltage .....	9.4	volts
Zero-Signal Plate Current .....	47	mA
Maximum-Signal Plate Current .....	51	mA
Zero-Signal Grid-No.2 Current .....	11	mA
Maximum-Signal Grid-No.2 Current .....	17.7	mA
Effective Load Resistance (Plate-to-plate) .....	6000	ohms
Total Harmonic Distortion .....	6	per cent
Maximum-Signal Power Output .....	3.8	watts
<b>MAXIMUM CIRCUIT VALUES</b>		
Grid-No.1-Circuit Resistance:		
For fixed-bias operation .....	0.1	megohm
For cathode-bias operation .....	0.5	megohm



**6EH7**  
**6EH7/**  
**EF183**  
3EH7, 4EH7

**SEMIREMOTE-CUTOFF  
PENTODE**



9AQ

Miniature types used as if-amplifier tubes in color and black-and-white television receivers. Outlines section, 6C; require miniature 9-contact socket. Types 3EH7 and 4EH7 are identical with types 6EH7 and 6EH7/EF183 except for heater ratings.

	3EH7	4EH7	6EH7 6EH7/EF183	
Heater Voltage (ac/dc) .....	3.4	4.4	6.3	volts
Heater Current .....	0.6	0.45	0.3	ampere
Peak Heater-Cathode Voltage .....	$\pm 150$ max	$\pm 150$ max	$\pm 150$ max	volts

Direct Interelectrode Capacitances:

Grid No.1 to Plate .....	0.005 max	pF
Grid No.1 to Cathode, Heater, Grid No.2, Grid No.3, and Internal Shield .....	9	pF
Plate to Cathode, Heater, Grid No.2, Grid No.3, and Internal Shield .....	3	pF

**Class A<sub>1</sub> Amplifier**

**MAXIMUM RATINGS (Design-Center Values)**

Plate Supply Voltage .....	550	volts
Plate Voltage .....	250	volts
Grid-No.3 (Suppressor-Grid) Voltage, Positive value .....	0	volts
Grid-No.2 (Screen-Grid) Supply Voltage .....	550	volts
Grid-No.2 Voltage .....	250	volts
Cathode Current .....	20	mA
Plate Dissipation .....	2.5	watts
Grid-No.2 Input .....	0.65	watt

**CHARACTERISTICS**

Plate Voltage .....	200	volts
Grid No.3 .....	Connected to cathode at socket	
Grid-No.2 Voltage .....	90	volts
Grid-No.1 Voltage .....	-2	volts
Plate Resistance (Approx.) .....	0.5	megohm
Transconductance .....	12500	μmhos
Plate Current .....	12	mA
Grid-No.2 Current .....	4.5	mA

**TYPICAL OPERATION**

Plate Voltage .....	200	200	200	200	volts
Grid No.3 .....	Connected to cathode at socket				
Grid-No.2 Supply Voltage .....	200	200	200	200	volts
Grid-No.2 Series Resistor .....	22000	22000	22000	22000	ohms
Grid-No.1 Voltage .....	-19.5	-9.5	-6.5	-2	volts
Transconductance .....	125	625	1250	12500	μmhos
RMS Grid-No.1 Voltage, for cross-modulation factor of 0.01 .....	450	160	100	—	mV

**MAXIMUM CIRCUIT VALUE**

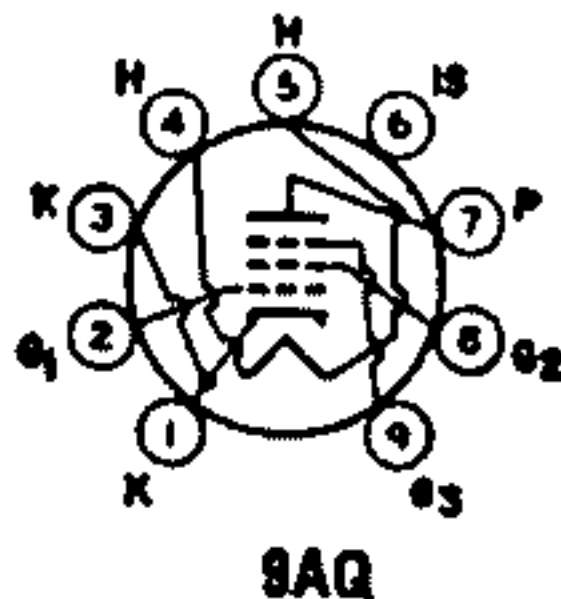
Grid-No.1-Circuit Resistance .....	1	megohm
------------------------------------	---	--------

See chart at end of section.

**6EH8**

Refer to chart at end of section.

**6EJ7**



**SHARP-CUTOFF PENTODE**

**6EJ7/  
EF184**

3EJ7, 4EJ7

Miniature types used as if-amplifier tubes in color and black-and-white television receivers. Outlines section, 6C; require miniature 9-contact socket. Types 3EJ7 and 4EJ7 are identical with type 6EJ7/EF184 except for heater ratings.

Heater Voltage (ac/dc) .....	3EJ7	4EJ7	6EJ7/EF184	
Heater Current .....	2.4	4.4	6.3	volts
Peak Heater-Cathode Voltage .....	0.6	0.45	0.8	ampere
Direct Interelectrode Capacitances:	±150 max	±160 max	±150 max	volts
Grid No.1 to Plate .....	0.005 max			pF
Grid No.1 to Cathode, Heater, Grid No.2, Grid No.3, and Internal Shield .....	10			pF
Plate to Cathode, Heater, Grid No.2, Grid No.3, and Internal Shield .....	3			pF

**Class A<sub>1</sub> Amplifier**

**MAXIMUM RATINGS (Design-Center Values)**

Plate Supply Voltage .....	550	volts
Plate Voltage .....	250	volts
Grid-No.2 (Screen-Grid) Supply Voltage .....	550	volts
Grid-No.2 Voltage .....	250	volts
Cathode Current .....	25	mA
Plate Dissipation .....	2.5	watts
Grid-No.2 Input .....	0.9	watt

**CHARACTERISTICS**

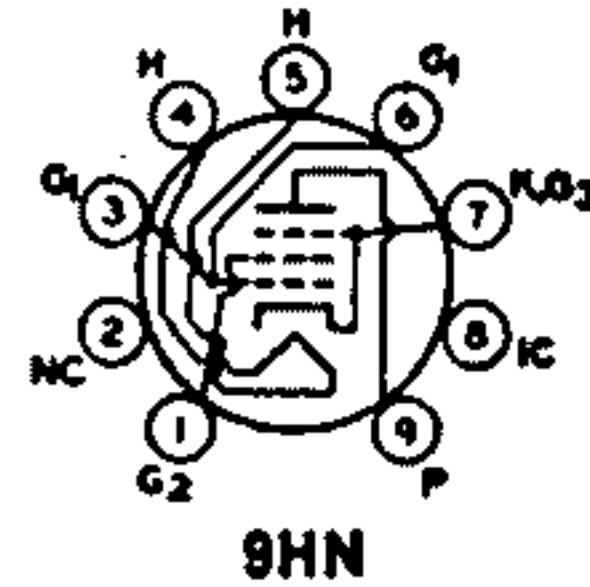
Plate Voltage	190	200	volts
Grid No.3	Connected to cathode at socket		
Grid-No.2 Voltage	190	200	volts
Grid-No.1 Voltage	-2.35	-2.5	volts
Plate Resistance (Approx.)	0.35	0.35	megohm
Transconductance	16000	15000	μmhos
Plate Current	10	10	mA
Grid-No.2 Current	4.1	4.1	mA
<b>MAXIMUM CIRCUIT VALUE</b>			
Grid-No.1-Circuit Resistance		1	megohm

**6EM5**

8EM5

**BEAM POWER TUBE**

Miniature type used as vertical-deflection amplifier in television receivers utilizing picture tubes having diagonal deflection angles of 110 degrees. Outlines section, 6G; requires miniature 9-contact socket. Type 8EM5 is identical with type 6EM5 except for heater ratings.



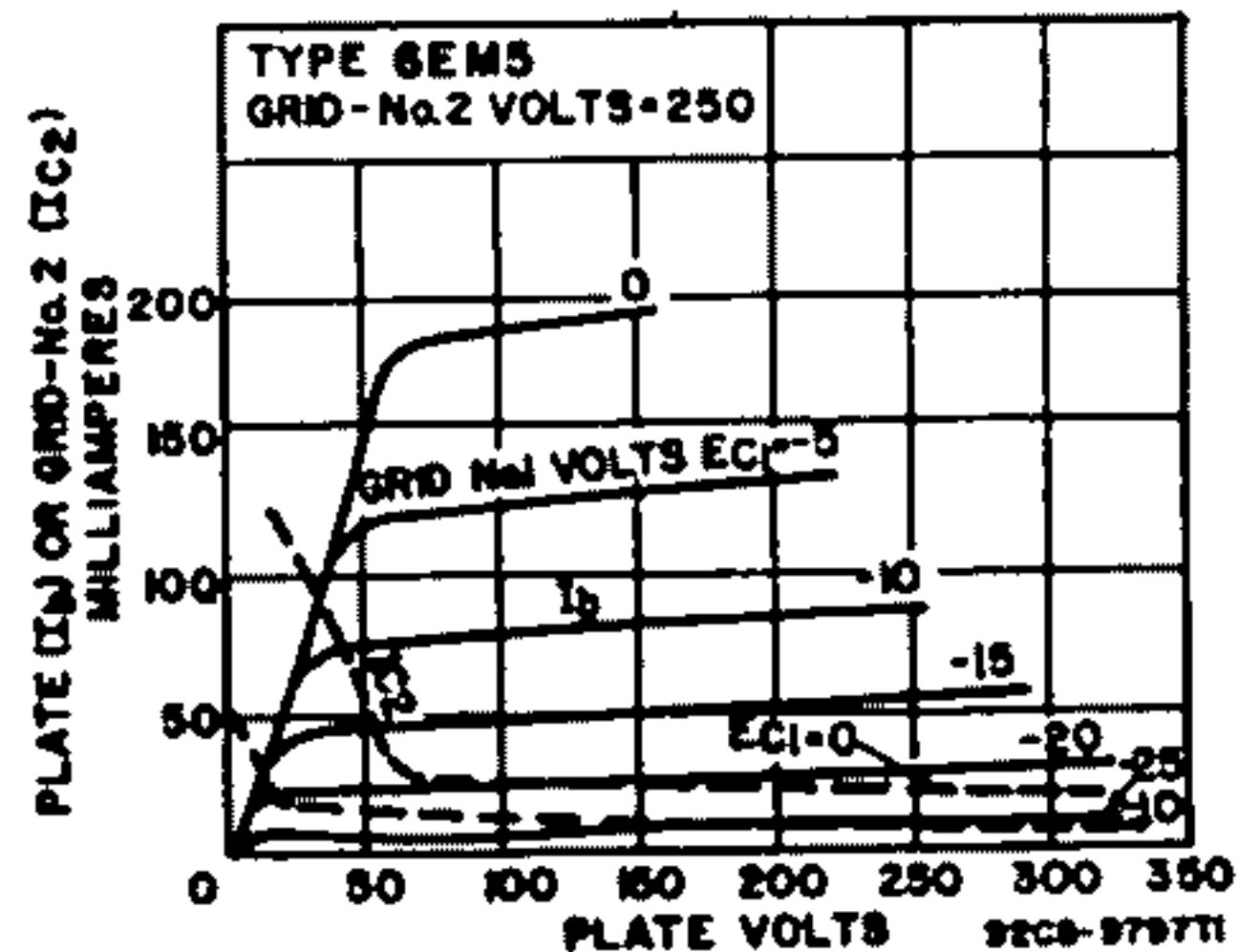
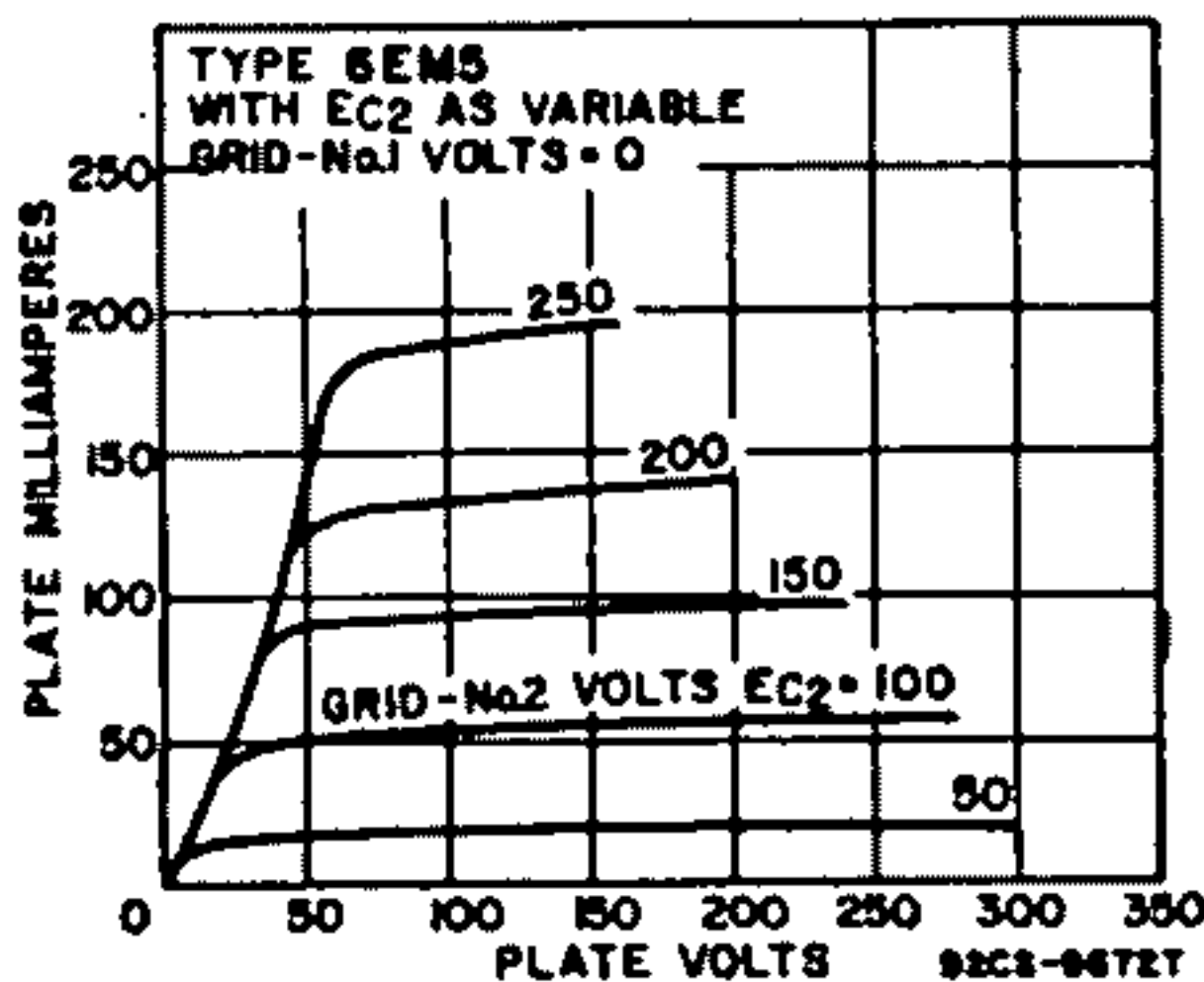
Heater Voltage (ac/dc)	6.3	8.4	volts
Heater Current	0.8	0.6	ampere
Heater Warm-up Time (Average)	—	11	seconds
<b>Heater-Cathode Voltage:</b>			
Peak value	±200 max	±200 max	volts
Average value	100 max	100 max	volts
<b>Direct Interelectrode Capacitances:</b>			
Grid No.1 to Plate		0.7 max	pF
Grid No.1 to Cathode, Heater, Grid No.2, and Grid No.3		10	pF
Plate to Cathode, Heater, Grid No.2, and Grid No.3		5.1	pF

**Class A<sub>1</sub> Amplifier**

**CHARACTERISTICS**

Plate Voltage	60	250	volts
Grid-No.2 Voltage	250	250	volts
Grid-No.1 Voltage	0	-18	volts
Mu Factor, Grid No.1 to Grid No.2	—	8.7	
Plate Resistance	—	0.05	megohm
Transconductance	—	5100	μmhos
Plate Current	180*	40	mA
Grid-No.2 Current	30*	8	mA
Grid-No.1 Voltage (Approx.) for plate current of 0.2 mA	—	-37	volts

\* These values can be measured by a method involving a recurrent waveform such that the maximum ratings of the tube will not be exceeded.





**Vertical-Deflection Oscillator and Amplifier**

For operation in a 525-line, 30-frame system

**MAXIMUM RATINGS (Design-Center Values)**

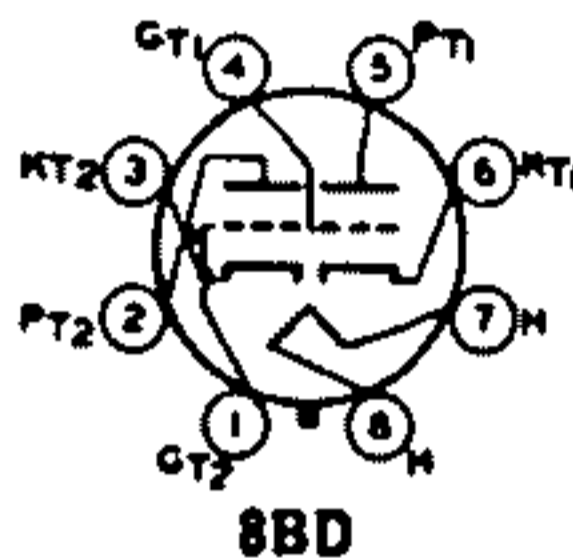
DC Plate Voltage	315	volts
Peak Positive-Pulse Plate Voltage* (Absolute Maximum)	2200 <sup>A</sup>	volts
Grid-No.2 (Screen-Grid) Voltage	285	volts
Peak Negative-Pulse Grid-No.1 (Control-Grid) Voltage	-250	volts
Peak Cathode Current	210	mA
Average Cathode Current	60	mA
Plate Dissipation	10	watts
Grid-No.2 Input	1.5	watts
Bulb Temperature (at hottest point)	250	°C

**MAXIMUM CIRCUIT VALUE**

Grid-No.1-Circuit Resistance	2.2	megohms
------------------------------	-----	---------

\* Pulse duration must not exceed 15% of a vertical scanning cycle (2.5 milliseconds).

<sup>A</sup> Under no circumstances should this absolute value be exceeded.



**DUAL TRIODE**

**6EM7**

10EM7, 13EM7

Glass octal type used as combined vertical-deflection amplifier and vertical-deflection oscillator in color and black-and-white television receivers. Outlines section, 13A; requires octal socket. For curve of average plate characteristics, Unit No.1, refer to type 6DR7 (Unit No.1). Types 10EM7 and 13EM7 are identical with type 6EM7 except for heater ratings.

	6EM7	10EM7	13EM7	
Heater Voltage (ac/dc)	6.3	9.7	13	volts
Heater Current	0.925	0.6	0.45	ampere
Heater Warm-up Time (Average)	—	11	11	seconds
Heater-Cathode Voltage:				
Peak value	±200 max	±200 max	±200 max	volts
Average value	100 max	100 max	100 max	volts
Direct Interelectrode Capacitances (Approx.):		Unit No.1	Unit No.2	
Grid to Plate		4.8	10	pF
Grid to Cathode and Heater		2.2	7	pF
Plate to Cathode and Heater		0.6	1.8	pF

**Class A<sub>1</sub> Amplifier**

CHARACTERISTICS	Unit No.1	Unit No.2	
Plate Voltage	250	150	volts
Grid Voltage	-3	-20	volts
Amplification Factor	64	5.4	
Plate Resistance (Approx.)	40000	750	ohms
Transconductance	1600	7200	μmhos
Plate Current	1.4	50	mA
Plate Current, for plate voltage of 60 volts and zero grid voltage	—	10	mA
Plate Current, for grid voltage of -28 volts	—	95	mA
Grid Voltage (Approx.):			
For plate current of 10 μA	-5.5	—	volts
For plate current of 100 μA	—	-45	volts

**Vertical-Deflection Oscillator and Amplifier**

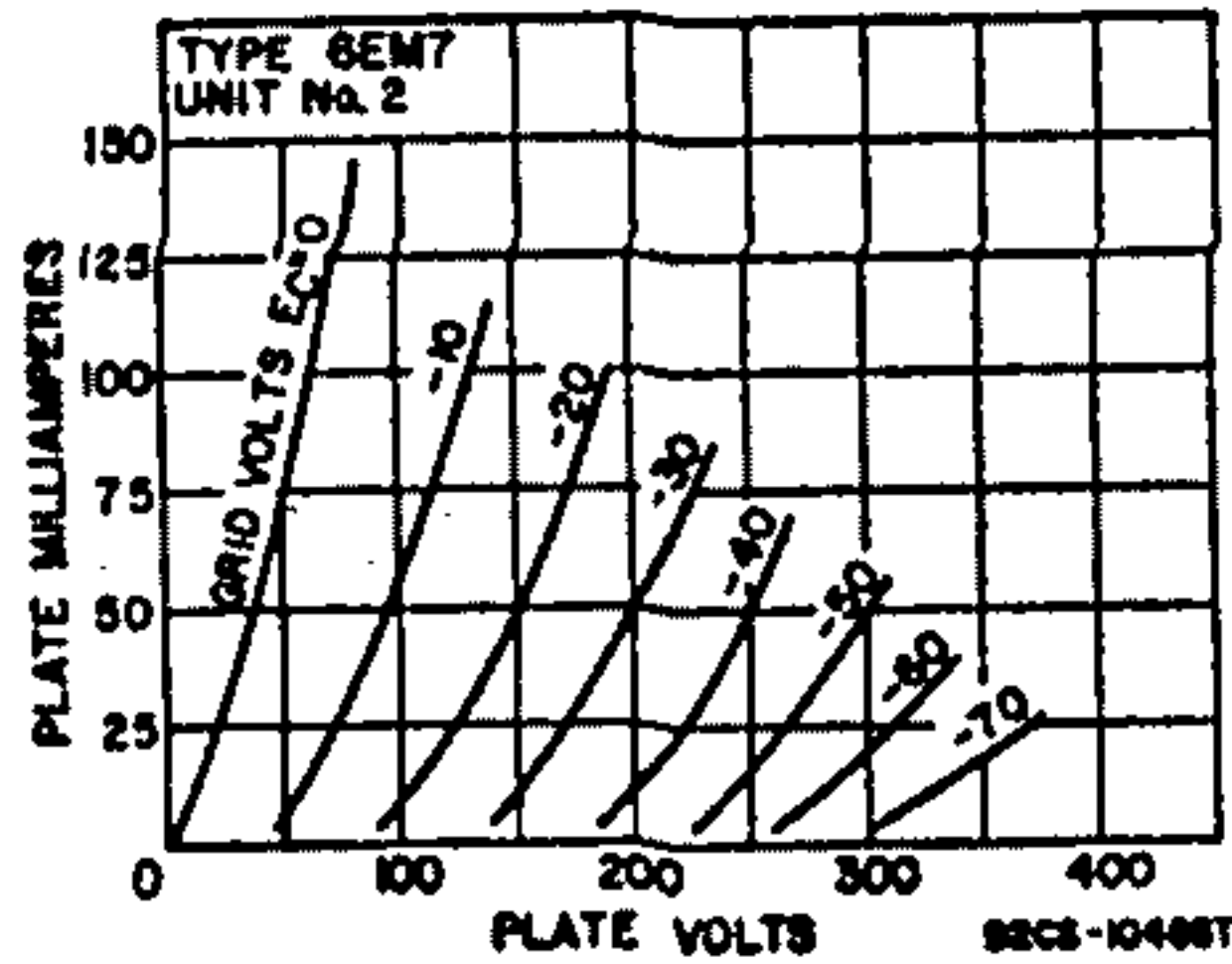
For operation in a 525-line, 30-frame system

MAXIMUM RATINGS (Design-Maximum Values)	Unit No.1 Oscillator	Unit No.2 Amplifier	
DC Plate Voltage	330	330	volts
Peak Positive-Pulse Plate Voltage*	—	1500	volts
Peak Negative-Pulse Grid Voltage	-400	-250	volts
Peak Cathode Current	77	175	mA
Average Cathode Current	22	50	mA
Plate Dissipation	1.5	10	watts

**MAXIMUM CIRCUIT VALUES**

Grid-Circuit Resistance:	Unit No.1	Unit No.2	
For grid-resistor-bias operation	2.2	2.2	megohms
For cathode-bias operation	2.2	2.2	megohms

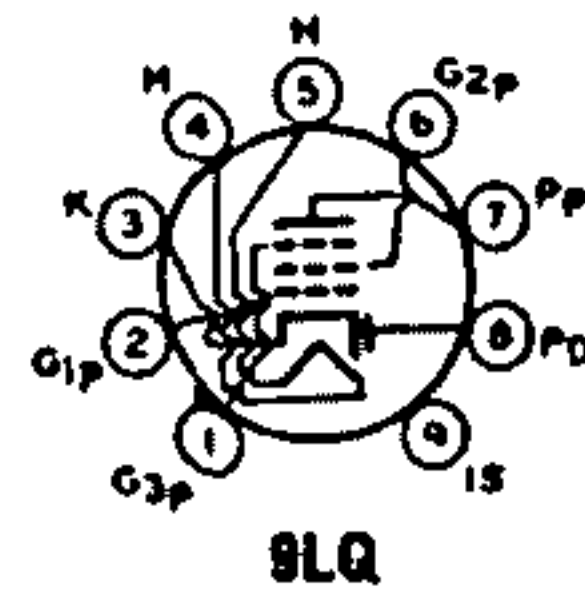
\* Pulse duration must not exceed 15% of a vertical scanning cycle (2.5 milliseconds).



**6EQ7**  
12EQ7

**DIODE—  
REMOTE-CUTOFF PENTODE**

Miniature type used as combined if amplifier and AM detector in AM and AM/FM radio receivers. Outlines section, 6E; requires miniature 9-contact socket. Type 12EQ7 is identical with type 6EQ7 except for heater ratings.



	6EQ7	12EQ7	
Heater Voltage (ac/dc)	6.3	12.6	volts
Heater Current	0.8	0.15	ampere
Heater-Cathode Voltage:			
Peak value	±200 max	±200 max	volts
Average value	100 max	100 max	volts
Direct Interelectrode Capacitances:			
Pentode Unit:			
Grid No.1 to Plate		0.002 max	pF
Grid No.1 to Cathode, Heater, Grid No.2, Grid No.3, and Internal Shield		5.5	pF
Plate to Cathode, Heater, Grid No.2, Grid No.3, and Internal Shield		5	pF
Pentode Grid No.1 to Diode Plate		0.0015 max	pF
Pentode Plate to Diode Plate		0.095	pF

**Pentode Unit as Class A<sub>1</sub> Amplifier**

MAXIMUM RATINGS (Design-Maximum Values)		
Plate Voltage	300	volts
Grid-No.3 (Suppressor-Grid) Voltage:		
Positive value	300	volts
Negative value	-300	volts
Grid-No.2 (Screen-Grid) Supply Voltage	300	volts
Grid-No.2 Voltage	See curve page 96	
Grid-No.1 (Control-Grid) Voltage:		
Positive-bias value	0	volts
Negative-bias value	-50	volts
Plate Dissipation	3	watts
Grid-No.3 Input	0.2	watt
Grid-No.2 Input:		
For grid-No.2 voltages up to 150 volts	0.6	watt
For grid-No.2 voltages between 150 and 300 volts	See curve page 96	
Bulb Temperature (At hottest point)	150	°C

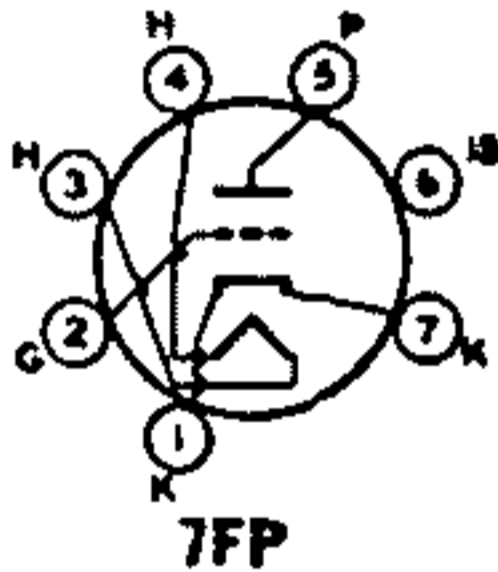
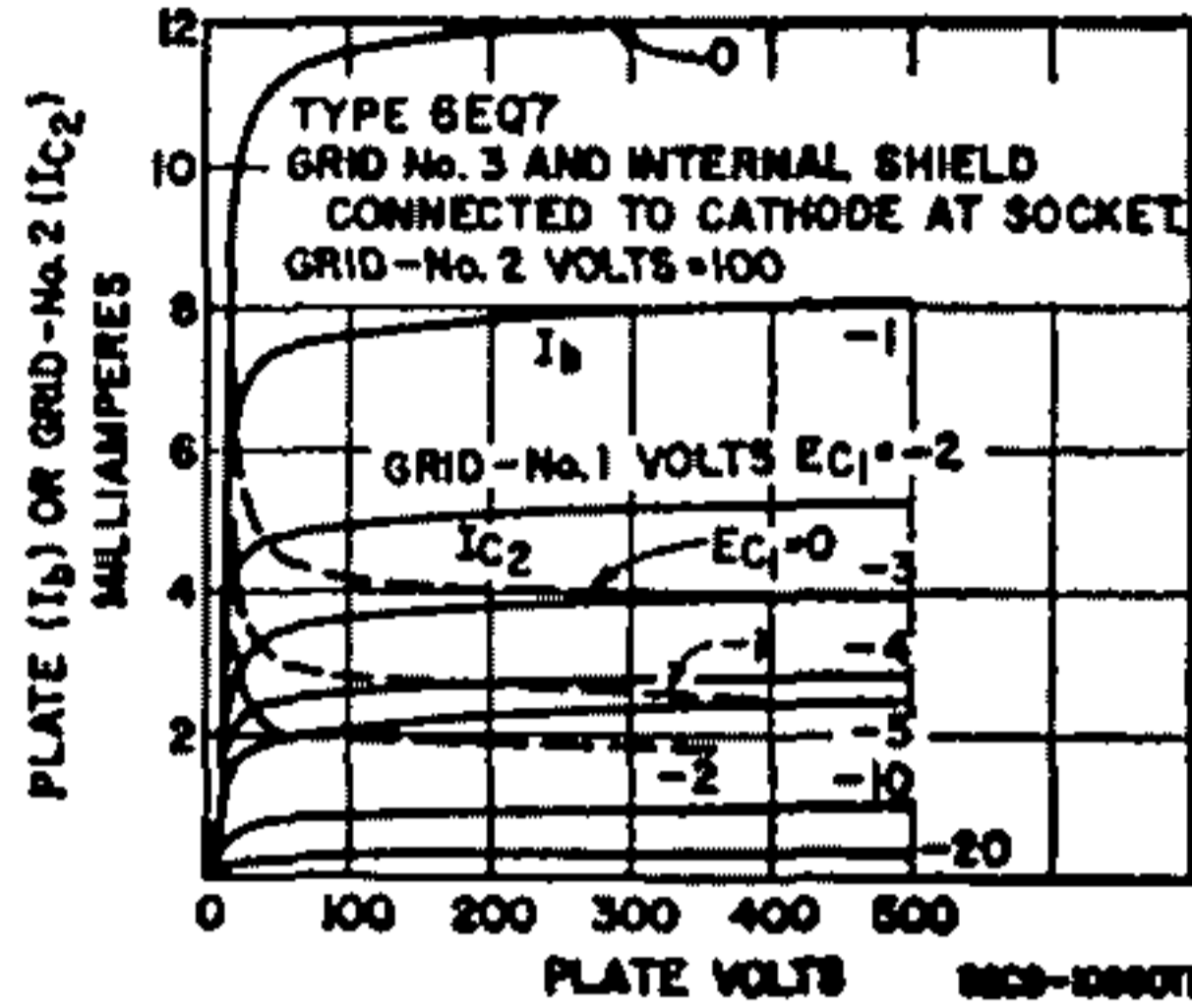
**CHARACTERISTICS**

Plate Voltage	100	volts
Grid No.3	Connected to cathode at socket	
Internal Shield	Connected to cathode at socket	
Grid-No.2 Voltage	100	volts
Grid-No.1 Supply Voltage	0	volts
Grid-No.1 Resistor (Bypassed)	2.2	megohms
Plate Resistance (Approx.)	0.25	megohm
Transconductance	3800	µmbos
Plate Current	9	mA
Grid-No.2 Current	3.5	mA
Grid-No.1 Voltage (Approx.) for transconductance of 40 µmbos	-20	volts

Diode Unit

MAXIMUM RATINGS (Design-Maximum Values)

Plate Current .....	1	mA
<b>CHARACTERISTICS, Instantaneous Value</b>		
Tube Voltage Drop for plate current of 2 mA .....	10	volts



HIGH-MU TRIODE

6ER5

2ER5, 3ER5

Miniature type with frame grid used in vhf tuners of color and black-and-white television receivers. Outlines section, 5C; requires miniature 7-contact socket. Types 2ER5 and 3ER5 are identical with type 6ER5 except for heater ratings.

Heater Voltage (ac/dc) .....	2.8	2.8	6.3	volts
Heater Current .....	0.6	0.45	0.18	ampere
Peak Heater-Cathode Voltage .....	±100 max	±100 max	±100 max	volts
<b>Direct Interelectrode Capacitances:</b>				
	Unshielded		Shielded*	
Grid to Plate .....	0.38	0.38		pF
Grid to Cathode, Heater, and Internal Shield ..	4.4	4.4		pF
Plate to Cathode, Heater, and Internal Shield ..	3	4		pF
Grid to Heater .....	0.28 max	0.28 max		pF
Plate to Cathode .....	0.24	0.24		pF
Cathode to Grid .....	3.1	3.1		pF
Heater to Cathode .....	2.5	2.5		pF

\* With external shield connected to cathode except as noted.  
 † With external shield connected to ground.

Class A<sub>1</sub> Amplifier

MAXIMUM RATINGS (Design-Center Values)

Plate Voltage .....	250	volts
Grid Voltage, Negative-bias value .....	-50	volts
Cathode Current .....	20	mA
Plate Dissipation .....	2.2	watts

CHARACTERISTICS

Plate Voltage .....	200	volts
Grid Voltage .....	-1.2	volts
Amplification Factor .....	80	
Plate Resistance (Approx.) .....	8000	ohms
Transconductance .....	10500	μmhos
Plate Current .....	10	mA
Grid Voltage (Approx.) for transconductance of 500 μmhos .....	-3.8	volts
Grid Voltage (Approx.) for transconductance of 100 μmhos .....	-5.6	volts

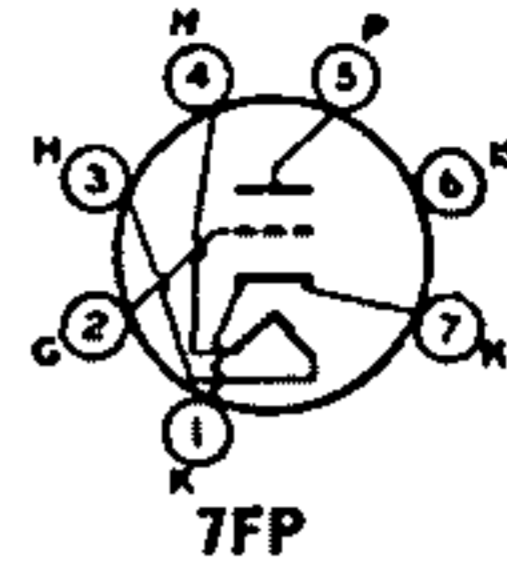
MAXIMUM CIRCUIT VALUE

Grid-Circuit Resistance .....	1	megohm
-------------------------------	---	--------



## 6ES5 HIGH-MU TRIODE

Miniature type used as grounded-cathode rf amplifier in vhf television receivers. Outlines section, 5C; requires miniature 7-contact socket.



Heater Voltage (ac/dc) .....	6.3	volts	
Heater Current .....	0.2	ampere	
Peak Heater-Cathode Voltage .....	±100 max	volts	
Direct Interelectrode Capacitances:	Unshielded	Shielded	
Grid to Plate .....	0.5 max	0.5 max	pF
Grid to Cathode, Heater, and Internal Shield ..	3.2	3.2	pF
Plate to Cathode, Heater, and Internal Shield ..	3.2	4	pF

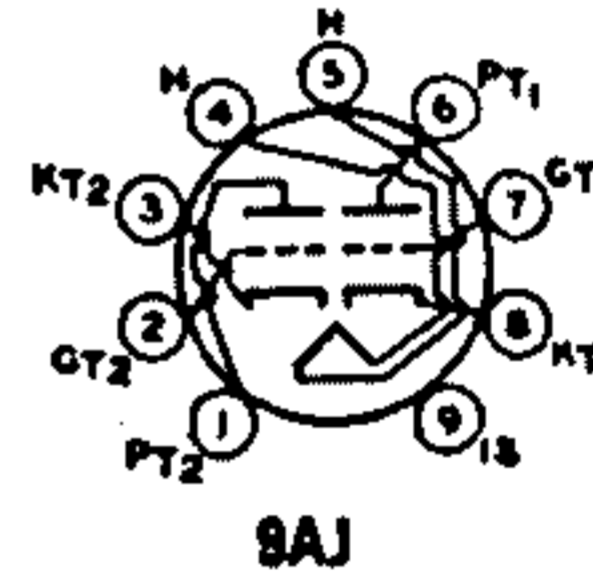
### Class A<sub>1</sub> Amplifier

<b>MAXIMUM RATINGS (Design-Maximum Values)</b>		
Plate Voltage .....	250	volts
Grid Voltage, Positive-bias value .....	0	volts
Cathode Current .....	22	mA
Plate Dissipation .....	2.2	watts
<b>CHARACTERISTICS</b>		
Plate Voltage .....	200	volts
Grid Voltage .....	-1	volt
Amplification Factor .....	75	
Plate Resistance (Approx.) .....	8000	ohms
Transconductance .....	9000	μmhos
Plate Current .....	10	mA
Grid Voltage (Approx.) for plate current of 100 μA .....	-6	volts
<b>MAXIMUM CIRCUIT VALUE</b>		
Grid-Circuit Resistance .....	1	megohm

## 6ES8 6ES8/ ECC189 VARIABLE-MU TWIN TRIODE

4ES8

Miniature type used as cascode-type amplifier in tuners of television receivers. Outlines section, 6B; requires miniature 9-contact socket. Type 4ES8 is identical with types 6ES8 and 6ES8/ECC189 except for heater ratings.



	4ES8	6ES8	6ES8/ECC189	
Heater Voltage (ac/dc) .....	4	6.3		volts
Heater Current .....	0.6	0.365		ampere
Heater Warm-up Time (Average) .....	11	—		seconds
Direct Interelectrode Capacitances:	Unshielded	Shielded*		
Grid to Plate (Each Unit) .....	1.9	1.9		pF
Plate to Cathode (Each Unit) .....	0.18	0.17		pF
Heater to Cathode (Each Unit) .....	3	3 <sup>Δ</sup>		pF
Plate of Unit No.2 to Plate of Unit No.1 .....	0.04 max	0.015 max		pF
Plate of Unit No.2 to Grid of Unit No.1 .....	0.003 max	0.003 max		pF
Grid of Unit No.1 to Cathode of Unit No.2 .....	0.002 max	0.002 max		pF

\* With external shield connected to cathode of unit under test except as noted.

Δ With external shield connected to ground.

### Class A<sub>1</sub> Amplifier (Each Unit)

<b>CHARACTERISTICS</b>				
Plate Voltage .....	90	90	90	volts
Grid Voltage .....	-1.2	-6	-9	volts
Plate Resistance (Approx.) .....	2500	—	—	ohms
Transconductance .....	12500	625	125	μmhos
Plate Current .....	15	—	—	mA

**Cascode-Type Amplifier**

**MAXIMUM RATINGS (Design-Maximum Values)**

Plate Supply Voltage with plate current of 0 mA .....	550	volts
Plate Voltage (Each unit) .....	130	volts
Grid Voltage, Negative-bias value (Each unit) .....	-50	volts
Cathode Current (Each unit) .....	22	mA
Plate Dissipation (Each unit) .....	1.8	watts
Heater-Cathode Voltage:		
Unit No.1:*		
RMS voltage between cathode and heater .....	50	volts
Unit No.2:*		
RMS voltage between cathode and heater*	50	volts
DC voltage between cathode and heater*	130	volts

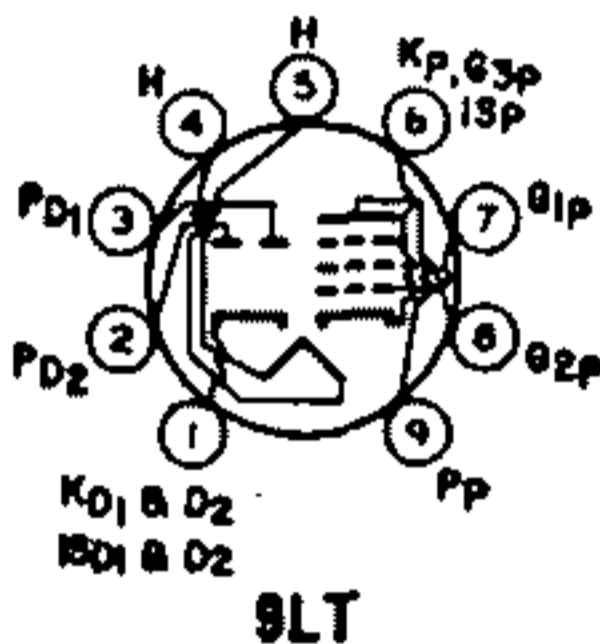
**TYPICAL OPERATION in a cascode-type circuits**

Supply Voltage .....	130	volts
Plate Current .....	15	mA
Transconductance .....	12500	$\mu$ mbos
Noise Figure* .....	6.5	dB
Grid Voltage (Approx.) for transconductance of 125 $\mu$ mbos .....	-9	volts
Input Voltage for cross-modulation factor of 0.01 and transconductance of 125 $\mu$ mbos .....	500	mV

**MAXIMUM CIRCUIT VALUES**

Grid-Circuit Resistance (Each unit) .....	1	megohm
---	---	--------

- \* Grounded-cathode input unit—pins 6, 7, and 8.
- Grounded-grid output unit—pins 1, 2, and 3.
- Cathode positive with respect to heater.
- With grid of output unit connected to a voltage divider.
- \* Measured with tube operating in a television tuner.



**TWIN DIODE—  
SHARP-CUTOFF PENTODE**

**6ET7  
8ET7**

Miniature type used in television receiver applications. The pentode unit is used as a video amplifier and the diodes are used as a horizontal phase inverter. Outlines section, 6E; requires miniature 9-contact socket. Type 8ET7 is identical with type 6ET7 except for heater ratings.

Heater Voltage (ac/dc) .....	6ET7 6.3	8ET7 8	volts
Heater Current .....	0.75	0.6	ampere
Heater Warm-up Time (Average) .....	—	11	seconds
Heater-Cathode Voltage:			
Peak value .....	$\pm 200$ max	$\pm 200$ max	volts
Average value .....	100 max	100 max	volts

**Pentode Unit as Class A<sub>1</sub> Amplifier**

**MAXIMUM RATINGS (Design-Maximum Values)**

Plate Voltage .....	330	volts
Grid-No.2 (Screen-Grid) Supply Voltage .....	330	volts
Grid-No.2 Voltage .....	See curve page 96	
Grid-No.1 (Control-Grid) Voltage, Positive-bias value .....	0	volts
Plate Dissipation .....	5	watts
Grid-No.2 Input:		
For grid-No.2 voltages up to 165 volts .....	1.1	watts
For grid-No.2 voltages between 165 and 330 volts .....	See curve page 96	

**CHARACTERISTICS**

Plate Supply Voltage .....	60	200	volts
Grid-No.2 Supply Voltage .....	150	150	volts
Grid-No.1 Voltage .....	0	—	volts
Cathode-Bias Resistor .....	—	100	ohms
Plate Resistance (Approx.) .....	—	60000	ohms
Transconductance .....	—	11500	$\mu$ mbos
Plate Current .....	55*	25	mA
Grid-No.2 Current .....	18*	5.5	mA
Grid-No.1 Voltage (Approx.) for plate current of 100 $\mu$ A .....	—	-10	volts

**MAXIMUM CIRCUIT VALUES**

Grid-No.1-Circuit Resistance:

For fixed-bias operation .....	0.1	megohm
For cathode-bias operation .....	0.25	megohm

\* This value can be measured by a method involving a recurrent waveform such that the maximum ratings of the tube will not be exceeded.

**Diode Units (Each Unit)**

**MAXIMUM RATINGS (Design-Maximum Values)**

Average Plate Current .....	3	mA
-----------------------------	---	----

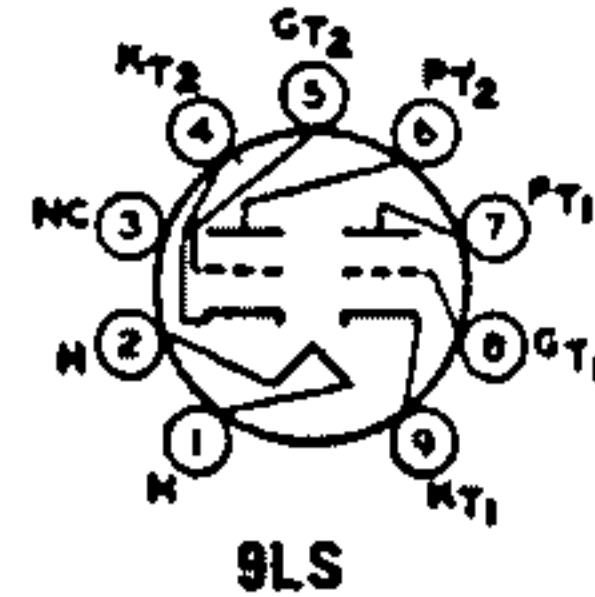
**CHARACTERISTICS, Instantaneous Value**

Tube Voltage Drop for plate current of 1.5 mA .....	10	volts
---	----	-------

**6EU7**

**HIGH-MU TWIN TRIODE**

Miniature type used in high-gain, resistance-coupled, low-level audio-amplifier applications where low-hum and non-microphonic characteristics are important, such as microphone amplifiers and pre-amplifiers for phonographs. Outlines section, 6B; requires miniature 9-contact socket. For typical operation as a resistance-coupled amplifier, refer to Resistance-Coupled Amplifier section.



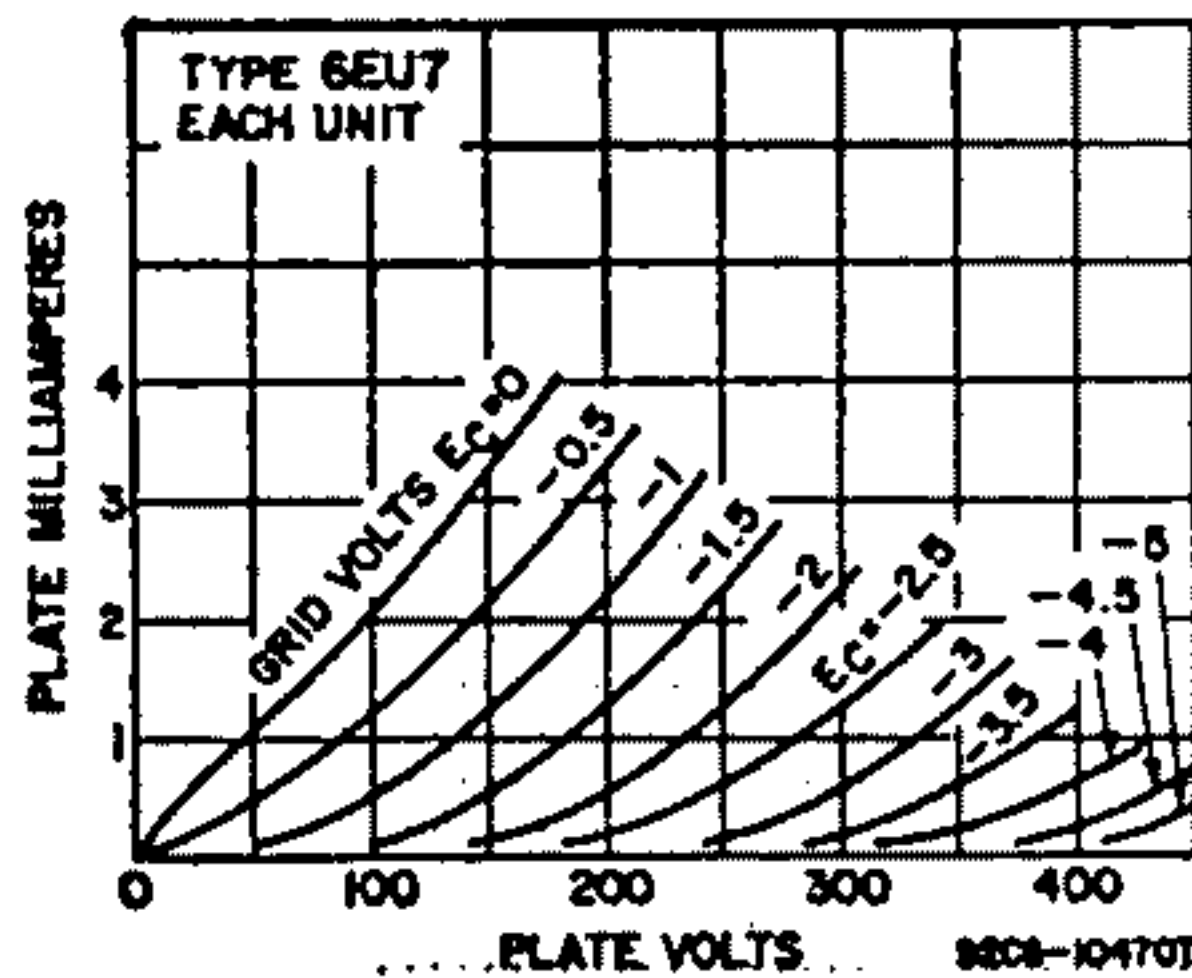
Heater Voltage (ac/dc) .....	6.3	volts
Heater Current .....	0.8	ampere
Heater-Cathode Voltage:		
Peak value .....	±200 max	volts
Average value .....	100 max	volts
Direct Interelectrode Capacitances (Each Unit, Approx.):		
Grid to Plate .....	1.5	pF
Grid to Cathode and Heater .....	1.6	pF
Plate to Cathode and Heater .....	0.2	pF
Equivalent Noise and Hum Voltage (Referenced to Grid, Each Unit):		
Average Value* .....	1.8	microvolts rms

\* Measured in "true rms" units under the following conditions: Heater volts (ac), 6.3; center-tap of heater transformer grounded; plate supply volts, 250; plate load resistor, 10000 ohms; cathode resistor, 2700 ohms; cathode bypass capacitor, 100 μF; grid resistor, 0 ohms; amplifier frequency range, 25 to 10000 Hz.

**Class A<sub>1</sub> Amplifier (Each Unit)**

**MAXIMUM RATINGS (Design-Maximum Values)**

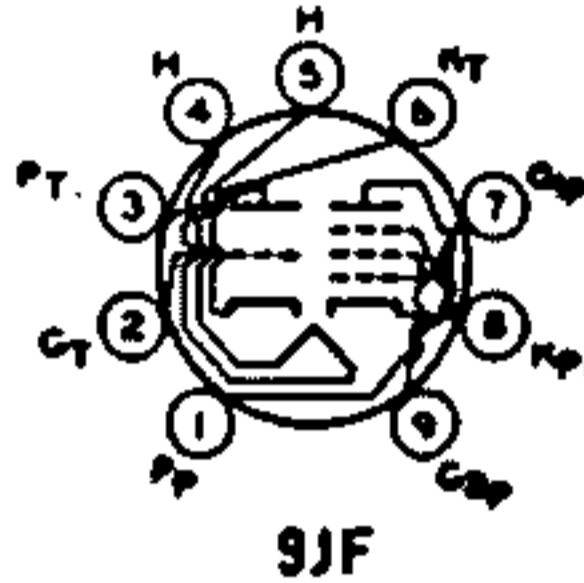
Plate Voltage .....	330	volts
Grid Voltage:		
Negative-bias value .....	-55	volts
Positive-bias value .....	0	watts
Plate Dissipation .....	1.2	watts





**CHARACTERISTICS**

Plate Voltage .....	100	250	volts
Grid Voltage .....	-1	-2	volts
Amplification Factor .....	100	100	
Plate Resistance (Approx.) .....	80000	62500	ohms
Transconductance .....	1250	1600	$\mu$ mhos
Plate Current .....	0.5	1.2	mA



9JF

**MEDIUM-MU TRIODE—  
SHARP-CUTOFF PENTODE**

**6EU8**  
5EU8

Miniature type used as combined triode oscillator and pentode mixer in television receivers. Outlines section, 6B; requires miniature 9-contact socket. Type 5EU8 is identical with type 6EU8 except for heater ratings.

Heater Voltage (ac/dc) .....	5EU8 4.7	6EU8 6.3	volts
Heater Current .....	0.6	0.45	ampere
Heater Warm-up Time (Average) .....	11	11	seconds
Heater-Cathode Voltage:			
Peak value .....	$\pm 200$ max	$\pm 200$ max	volts
Average value .....	100 max	100 max	volts

**Class A<sub>1</sub> Amplifier**

**MAXIMUM RATINGS (Design-Center Values)**

	Triode Unit	Pentode Unit	
Plate Voltage .....	330	330	volts
Grid-No.2 (Screen-Grid) Supply Voltage .....	—	330	volts
Grid-No.2 Voltage .....	—	See curve page 96	
Grid-No.1 (Control-Grid) Voltage, Positive-bias value .....	0	0	volts
Plate Dissipation .....	3	3.1	watts
Grid-No.2 Input:			
For grid-No.2 voltages up to 165 volts .....	—	0.55	watt
For grid-No.2 voltages between 165 and 330 volts .....	—	See curve page 96	

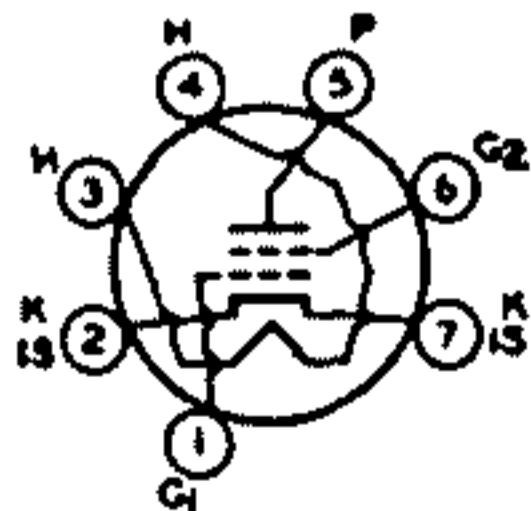
**CHARACTERISTICS**

Plate Supply Voltage .....	150	125	volts
Grid-No.2 Supply Voltage .....	—	125	volts
Grid-No.1 Voltage .....	—	-1	volt
Cathode-Bias Resistor .....	56	—	ohms
Amplification Factor .....	40	—	
Plate Resistance (Approx.) .....	5000	80000	ohms
Transconductance .....	8500	6400	$\mu$ mhos
Plate Current .....	18	12	mA
Grid-No.2 Current .....	—	4	mA
Cathode Warm-up Time* .....	35	—	seconds
Grid-No.1 Voltage (Approx.) for plate current of 10 $\mu$ A .....	-12	-9	volts

**MAXIMUM CIRCUIT VALUE**

Grid-No.1-Circuit Resistance .....	0.1	0.1	megohm
------------------------------------	-----	-----	--------

\* The cathode warm-up time is defined as the time required for the transconductance to reach 6500  $\mu$ mhos when the tube is operated from a cold start with dc plate volts = 100, grid volts = 0, and heater volts = 5.6.



7EW

**SHARP-CUTOFF TETRODE**

**6EV5**

Miniature type used as rf amplifier in vhf tuners of television receivers. Outlines section, 5C; requires miniature 7-contact socket.

Heater Voltage (ac/dc) .....	6.3	volts
Heater Current .....	0.2	ampere
Heater-Cathode Voltage:		
Peak value .....	$\pm 100$ max	volts
Average value .....	50 max	volts

Direct Interelectrode Capacitances:<sup>a</sup>

Grid No.1 to Plate .....	0.036 max	pF
Grid No.1 to Cathode, Heater, Grid No.2, and Internal Shield ..	4.5	pF
Plate to Cathode, Heater, Grid No.2, and Internal Shield ..	2.9	pF

<sup>a</sup> With external shield connected to cathode.

**Class A<sub>1</sub> Amplifier**

**MAXIMUM RATINGS (Design-Maximum Values)**

Plate Voltage .....	275	volts
Grid-No.2 (Screen-Grid) Supply Voltage .....	180	volts
Grid-No.2 Voltage .....	See curve page 96	
Grid-No.1 (Control-Grid) Voltage, Positive-bias value .....	0	volts
Cathode Current .....	20	mA
Plate Dissipation .....	3.25	watts
Grid-No.2 Input:		
For grid-No.2 voltages up to 90 volts .....	0.2	watt
For grid-No.2 voltages between 90 and 180 volts .....	See curve page 96	

**CHARACTERISTICS**

Plate Voltage .....	250	volts
Grid-No.2 Voltage .....	80	volts
Grid-No.1 Voltage .....	-1	volt
Plate Resistance (Approx.) .....	0.15	megohm
Transconductance .....	8800	μmhos
Plate Current .....	11.5	mA
Grid-No.2 Current .....	0.9	mA
Grid-No.1 Voltage (Approx.) for transconductance of 100 μmhos ..	-4.5	volts

**MAXIMUM CIRCUIT VALUE**

Grid-No.1-Circuit Resistance .....	0.5	megohm
------------------------------------	-----	--------

**6EV7**

See chart at end of section.

**6EW6**

4EW6, 5EW6

**SHARP-CUTOFF PENTODE**

Miniature type used in the gain-controlled picture-if stages of vhf color and black-and-white television receivers operating at an intermediate frequency in the order of 40 MHz. Outlines section, 5C; requires miniature 7-contact socket. Types 4EW6 and 5EW6 are identical with type 6EW6 except for heater ratings.



7CM

	4EW6	5EW6	6EW6	
Heater Voltage (ac/dc) .....	4.2	5.6	6.3	volts
Heater Current .....	0.6	0.45	0.4	ampere
Heater Warm-up Time (Average) .....	11	11	—	seconds
Heater-Cathode Voltage:				
Peak value .....	±200 max	±200 max	±200 max	volts
Average value .....	100 max	100 max	100 max	volts
Direct Interelectrode Capacitances:		Unshielded	Shielded*	
Grid No.1 to Plate .....		0.04 max	0.03 max	pF
Grid No.1 to Cathode, Heater, Grid No.2, Grid No.3, and Internal Shield .....		10	10	pF
Plate to Cathode, Heater, Grid No.2, Grid No.3, and Internal Shield .....		2.4	2.4	pF

\* With external shield connected to cathode.

**Class A<sub>1</sub> Amplifier**

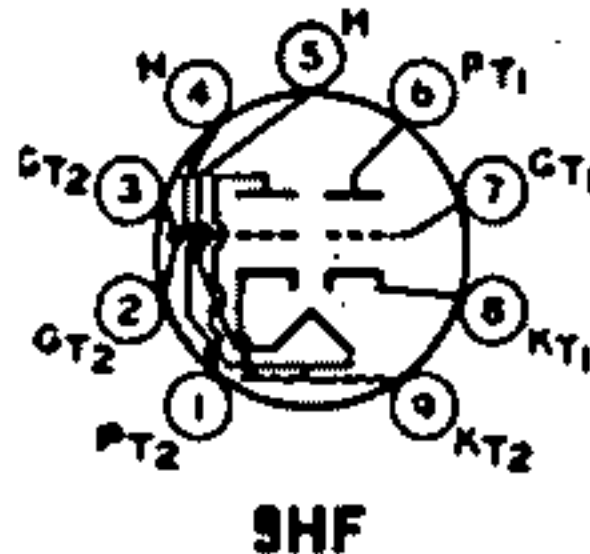
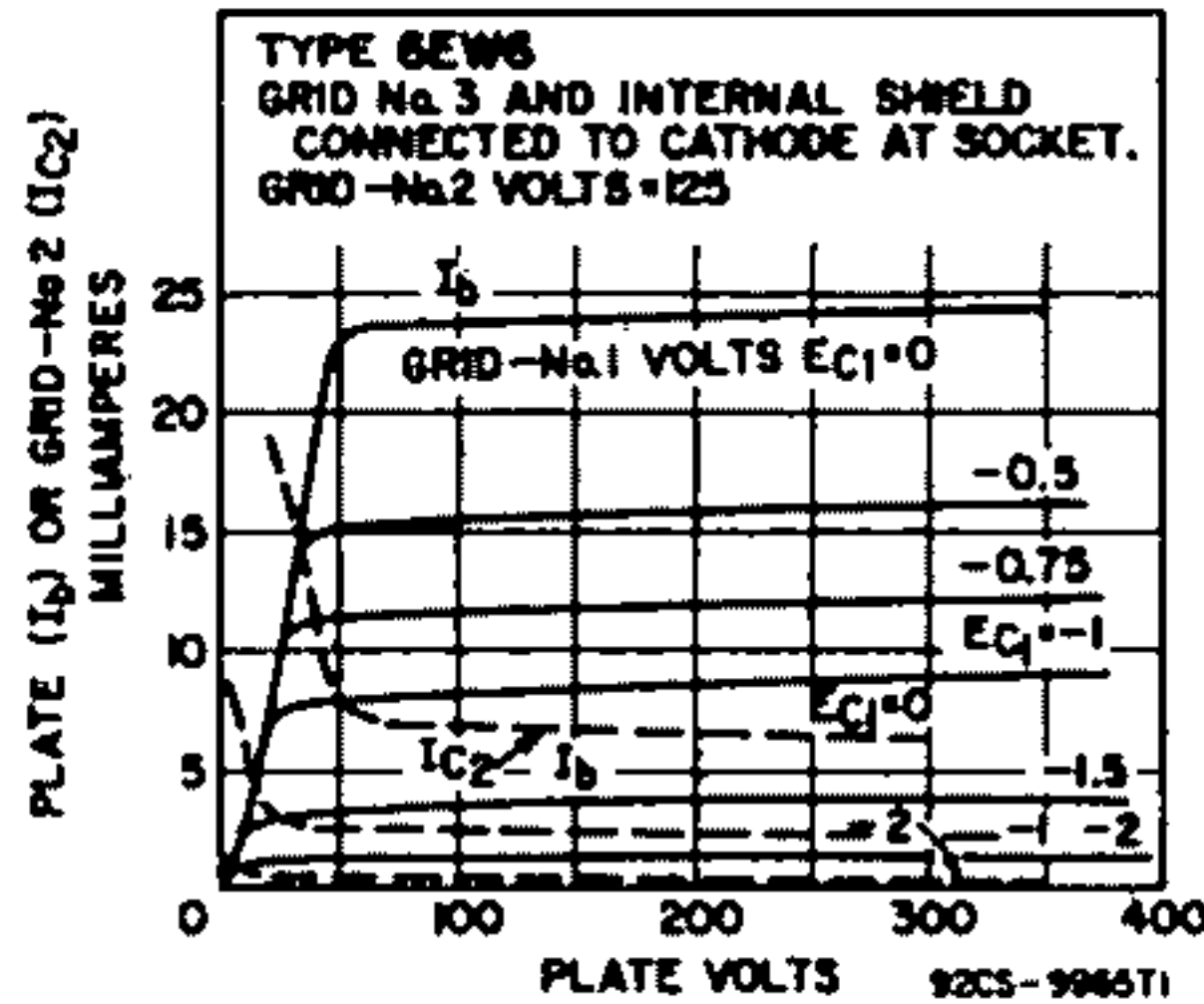
**MAXIMUM RATINGS (Design-Maximum Values)**

Plate Voltage .....	330	volts
Grid No.3 (Suppressor-Grid) Voltage, Positive value .....	0	volts
Grid-No.2 (Screen-Grid) Supply Voltage .....	330	volts
Grid-No.2 Voltage .....	See curve page 96	
Grid-No.1 (Control-Grid) Voltage, Positive-bias value .....	0	volts
Plate Dissipation .....	3.1	watts
Grid-No.2 Input:		
For grid-No.2 voltages up to 165 volts .....	0.65	watt
For grid-No.2 voltages between 165 and 330 volts .....	See curve page 96	

**CHARACTERISTICS**

Plate Supply Voltage .....	125	volts
Grid No.3 .....	Connected to cathode at socket	
Grid-No.2 Supply Voltage .....	125	volts
Cathode-Bias Resistor .....	56	ohms

Plate Resistance (Approx.) .....	0.2	megohm
Transconductance .....	14000	$\mu$ mhos
Plate Current .....	11	mA
Grid-No.2 Current .....	3.2	mA
Grid-No.1 Voltage (Approx.) for plate current of 20 $\mu$ A .....	-3.6	volts



DUAL TRIODE

6EW7

Neonovial type used as combined vertical-deflection oscillator and vertical-deflector amplifier in television receivers. Outlines section, 10C; requires neonovial 9-contact socket. For curve of average plate characteristics, Unit No.1, refer to type 6DE7 (Unit No.1).

Heater Voltage (ac/dc) .....	6.3	volts	
Heater Current .....	0.9	ampere	
Heater-Cathode Voltage:			
Peak value .....	$\pm 200$ max	volts	
Average value .....	100 max	volts	
Direct Interelectrode Capacitances (Approx.):	Unit No.1	Unit No.2	
Grid to Plate .....	4.2	9	pF
Grid to Cathode and Heater .....	2.2	7	pF
Plate to Cathode and Heater .....	0.4	1.2	pF

Class A<sub>1</sub> Amplifier

<b>CHARACTERISTICS</b>	Unit No.1	Unit No.2	
Plate Voltage .....	250	150	volts
Grid Voltage .....	-11	-17.5	volts
Amplification Factor .....	17.5	8	
Plate Resistance (Approx.) .....	8750	800	ohms
Transconductance .....	2000	7500	$\mu$ mhos
Plate Current .....	5.5	45	mA
Plate Current for plate voltage of 60 volts and zero grid voltage .....	—	95	mA
Plate Current for grid voltage of -25 volts .....	—	8	mA
Grid Voltage (Approx.) for plate current of 10 $\mu$ A ..	-20	—	volts
Grid Voltage (Approx.) for plate current of 100 $\mu$ A ..	—	-40	volts

Vertical-Deflection Oscillator and Amplifier

For operation in a 525-line, 30-frame system

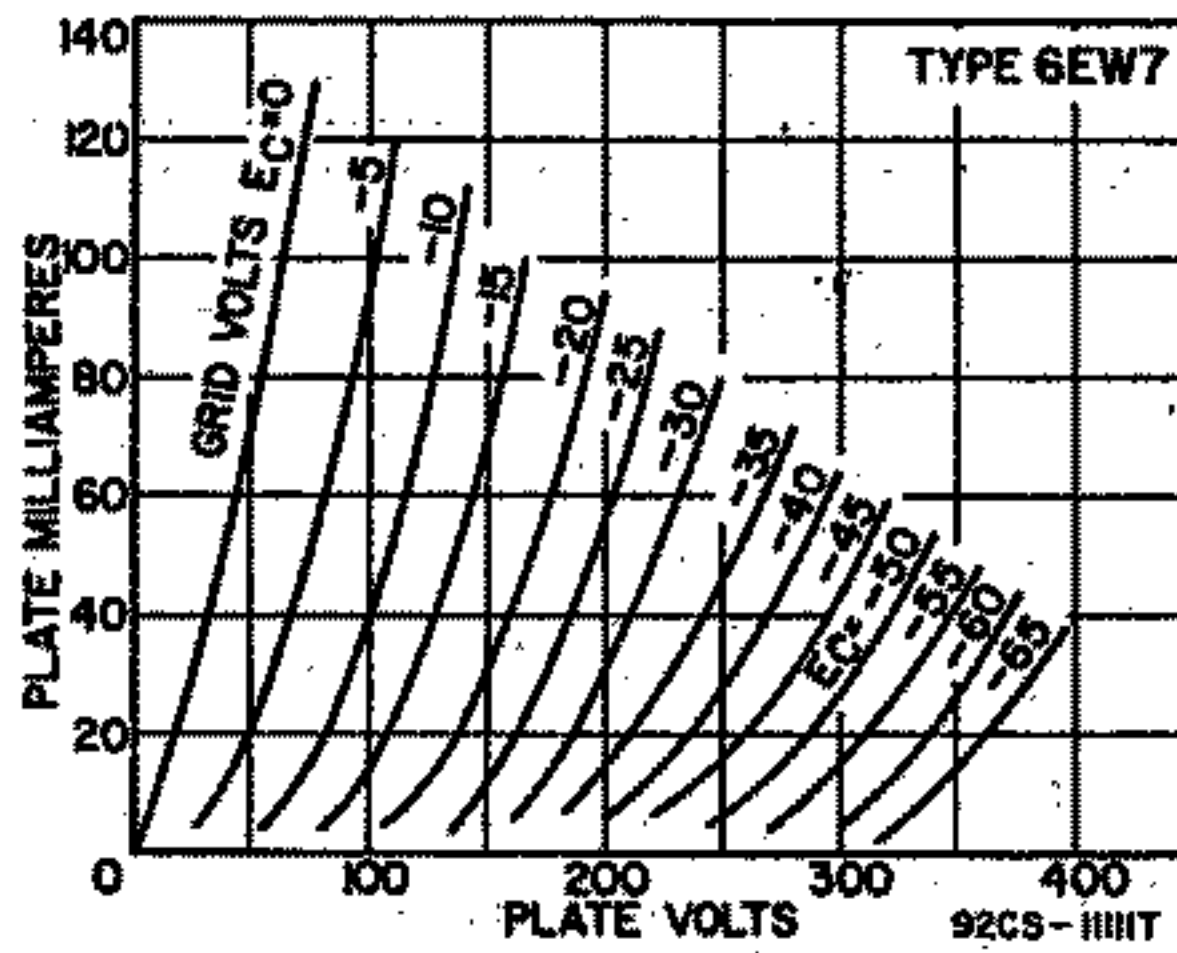
<b>MAXIMUM RATINGS (Design-Maximum Values)</b>	Unit No.1 Oscillator	Unit No.2 Amplifier	
DC Plate Voltage .....	330	330	volts
Peak Positive-Pulse Plate Voltage* .....	—	1500	volts
Peak Negative-Pulse Grid Voltage .....	-400	-250	volts
Peak Cathode Current .....	77	175	mA
Average Cathode Current .....	22	50	mA
Plate Dissipation .....	1.5	10	watts

MAXIMUM CIRCUIT VALUES

Grid-Circuit Resistance:			
For cathode-bias operation .....	2.2	2.2	megohms
For grid-resistor-bias operation .....	2.2	2.2	megohms

\* Pulse duration must not exceed 15% of a vertical scanning cycle (2.5 milliseconds).





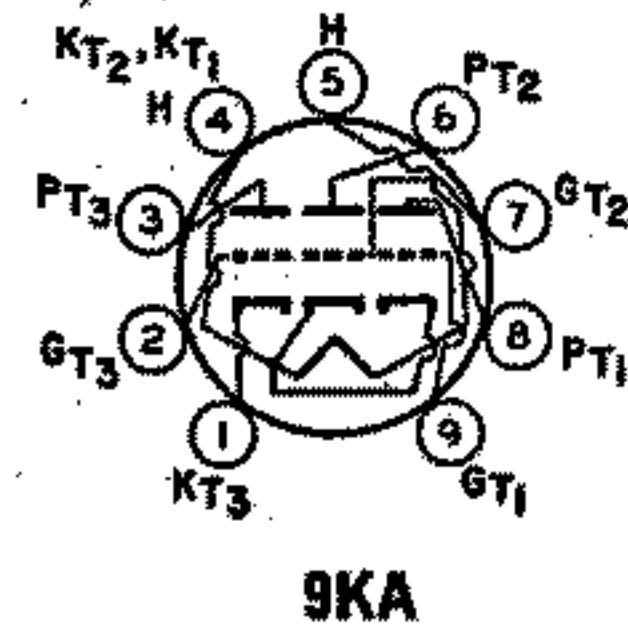
**6EX6**  
**6EY6**  
**6EZ5**

See chart at end of section.  
See chart at end of section.  
See chart at end of section.

**6EZ8**  
19EZ8

**HIGH-MU TRIPLE TRIODE**

Miniature type used in oscillator-mixer and afc service in FM receivers. Outlines section, 6B; requires miniature 9-contact socket. Type 19EZ8 is identical with type 6EZ8 except for heater ratings.



	6EZ8	19EZ8	
Heater Voltage (ac/dc)	6.3	18.9	volts
Heater Current	0.45	0.15	ampere
Peak Heater-Cathode Voltage		±100 max	volts

**Class A<sub>1</sub> Amplifier (Each Unit Unless Otherwise Specified)**

MAXIMUM RATINGS (Design-Maximum Values)		
Plate Voltage	330	volts
Grid Voltage:		
Negative-bias value	-50	volts
Positive-bias value	0	volts
Plate Dissipation	2	watts
Total Plate Dissipation (All plates)	5	watts
CHARACTERISTICS		
Plate Voltage	125	volts
Grid Voltage	1	volt
Amplification Factor	57	
Plate Resistance (Approx.)	13600	ohms
Transconductance	4200	μmhos
Plate Current	4.2	mA
Grid Voltage (Approx.) for plate current of 20 μA	-4	volts

**6F5**

See chart at end of section.

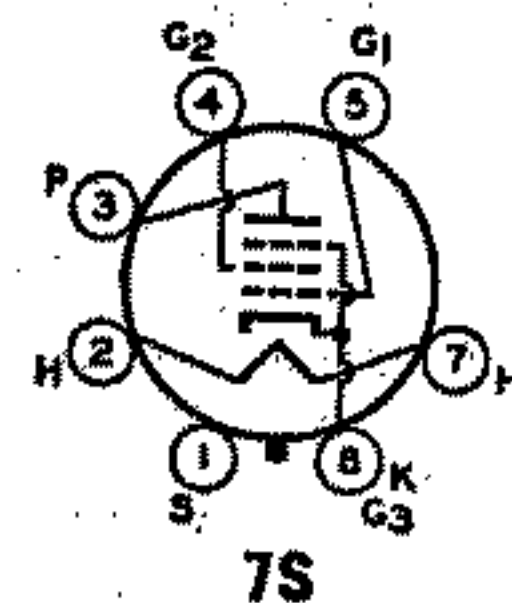
**6F5GT**

Refer to chart at end of section.

**6F6**

**POWER PENTODE**

Metal type used in the audio output stage of ac receivers. Outlines section, 2B; requires octal socket. This tube, like other power-handling tubes, should be adequately ventilated. Heater: volts (ac/dc), 6.3; amperes, 0.7; maximum heater-cathode volts, 90 peak.



**Class A<sub>1</sub> Amplifier**

MAXIMUM RATINGS (Design-Maximum Values)	Pentode Connection	Triode Connection <sup>A</sup>		
Plate Voltage	375	350	volts	
Grid-No.2 (Screen-Grid) Voltage	285	—	volts	
Plate Dissipation	11	10	watts	
Grid-No.2 Input	9.75	—	watts	
<b>TYPICAL OPERATION</b>				
Plate Voltage	250	285	250	volts
Grid-No.2 Voltage	250	285	—	volts
Grid-No.1 (Control-Grid) Voltage	-16.5	-20	-20	volts
Peak AF Grid-No.1 Voltage	16.5	20	20	volts
Zero-Signal Plate Current	84	38	31	mA
Maximum-Signal Plate Current	86	40	34	mA
Zero-Signal Grid-No.2 Current	6.5	7	—	mA
Maximum-Signal Grid-No.2 Current	10.5	13	—	mA
Amplification Factor	—	—	6.8	
Plate Resistance (Approx.)	80000	78000	2600	ohms
Transconductance	2500	2550	2600	μmhos
Load Resistance	7000	7000	4000	ohms
Total Harmonic Distortion	8	9	6.5	per cent
Maximum-Signal Power Output	8.2	4.8	0.85	watts

<sup>A</sup> Grid No.2 connected to plate.

**Push-Pull Class AB<sub>1</sub> Amplifier**

MAXIMUM RATINGS (Same as for class A<sub>1</sub> amplifier)

TYPICAL OPERATION (Values are for two tubes)

Plate Voltage	315	volts
Grid-No.2 Voltage	285	volts
Grid-No.1 Voltage	-24	volts
Peak AF Grid-No.1-to-Grid-No.1 Voltage	48	volts
Zero-Signal Plate Current	62	mA
Maximum-Signal Plate Current	80	mA
Zero-Signal Grid-No.2 Current	12	mA
Maximum-Signal Grid-No.2 Current	19.5	mA
Effective Load Resistance (Plate-to-plate)	10000	ohms
Total Harmonic Distortion	4	per cent
Maximum-Signal Power Output	11	watts

MAXIMUM CIRCUIT VALUES

Grid-No.1 Circuit Resistance:		
For fixed-bias operation	0.1	megohm
For cathode-bias operation	0.5	megohm

Refer to chart at end of section.

**6F6G**

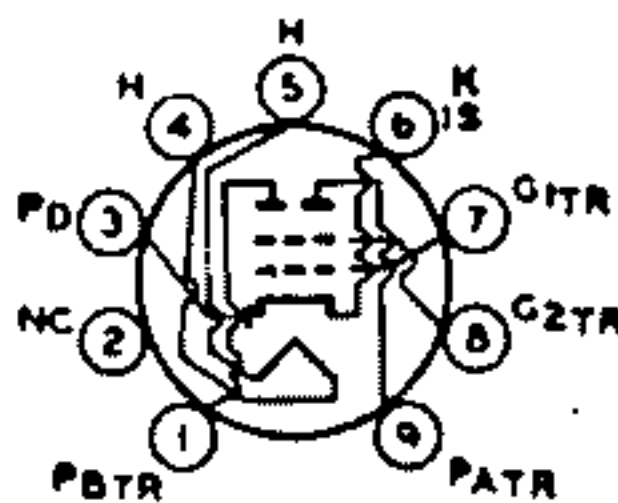
**6F6GT**

Refer to chart at end of section.

**6F7**

Refer to chart at end of section.

**6F8G**



**9MR**

**DIODE—SHARP-CUTOFF,  
TWIN-PLATE TETRODE**

**6FA7**

Miniature type used in television receivers and in frequency-divider and complex-wave generator circuits of electronic musical instruments. Outlines section, 6E; requires miniature 9-contact socket.

Heater Voltage (ac/dc)	6.3	volts
Heater Current	0.3	ampere
Heater-Cathode Voltage:		
Peak value	±200 max	volts
Average value	100 max	volts
Direct Interelectrode Capacitances:		
Tetrode Unit:		
Grid No.1 to Plate A	0.040	pF
Grid No.1 to Plate B	0.030 max	pF
Grid No.1 to Cathode, Heater, Grid No.2, and Internal Shield	5.5	pF
Plate A to Cathode, Heater, Grid No.2, and Internal Shield	1.8	pF
Plate B to Cathode, Heater, Grid No.2, and Internal Shield	1.8	pF

Tetrode Grid No.1 to Diode Plate .....	0.022	pF
Tetrode Plate A to Diode Plate .....	0.020 max	pF
Tetrode Plate B to Diode Plate .....	0.055	pF

**Class A<sub>1</sub> Amplifier**

**CHARACTERISTICS (Tetrode Unit)**

Plate A and Plate B connected together

Plate Voltage .....	100	volts
Grid-No.2 Voltage .....	100	volts
Grid-No.1 Supply Voltage .....	0	volts
Grid-No.1 Resistor (Bypassed) .....	2.2	megohms
Plate Resistance (Approx.) .....	90000	ohms
Transconductance .....	3200	$\mu$ mbos
Plate Current .....	3.8	mA
Grid-No.2 Current .....	1.7	mA
Grid-No.1 Voltage (Approx.) for plate current of 20 $\mu$ A .....	-4	volts

Using either Plate A or B, with unused plate grounded

Plate Voltage .....	100	volts
Grid-No.2 Voltage .....	100	volts
Grid-No.1 Supply Voltage .....	0	volts
Grid-No.1 Resistor (Bypassed) .....	2.2	megohms
Plate Resistance (Approx.) .....	130000	ohms
Transconductance .....	1900	$\mu$ mbos
Plate Current .....	2.2	mA
Grid-No.2 Current .....	3	mA

**Frequency Divider and Complex-Wave Generator**

Tetrode Unit

**MAXIMUM RATINGS (Design-Maximum Values)**

Plate-A Voltage .....	330	volts
Plate-B Voltage .....	330	volts
Grid-No.2 (Screen-Grid) Supply Voltage .....	330	volts
Grid-No.2 Voltage .....	See curve page 96	
Grid-No.1 (Control-Grid) Voltage:		
Negative-bias value .....	-50	volts
Positive-bias value .....	0	volts
Plate-A Dissipation .....	1.5	watts
Plate-B Dissipation .....	1.5	watts
Grid-No.2 Input:		
For grid-No.2 voltages up to 165 volts .....	0.65	watt
For grid-No.2 voltages between 165 and 330 volts .....	See curve page 96	

**MAXIMUM CIRCUIT VALUE**

Grid-No.1-Circuit Resistance, for grid-No.1-resistor-bias operation .....	2.2	megohms
---	-----	---------

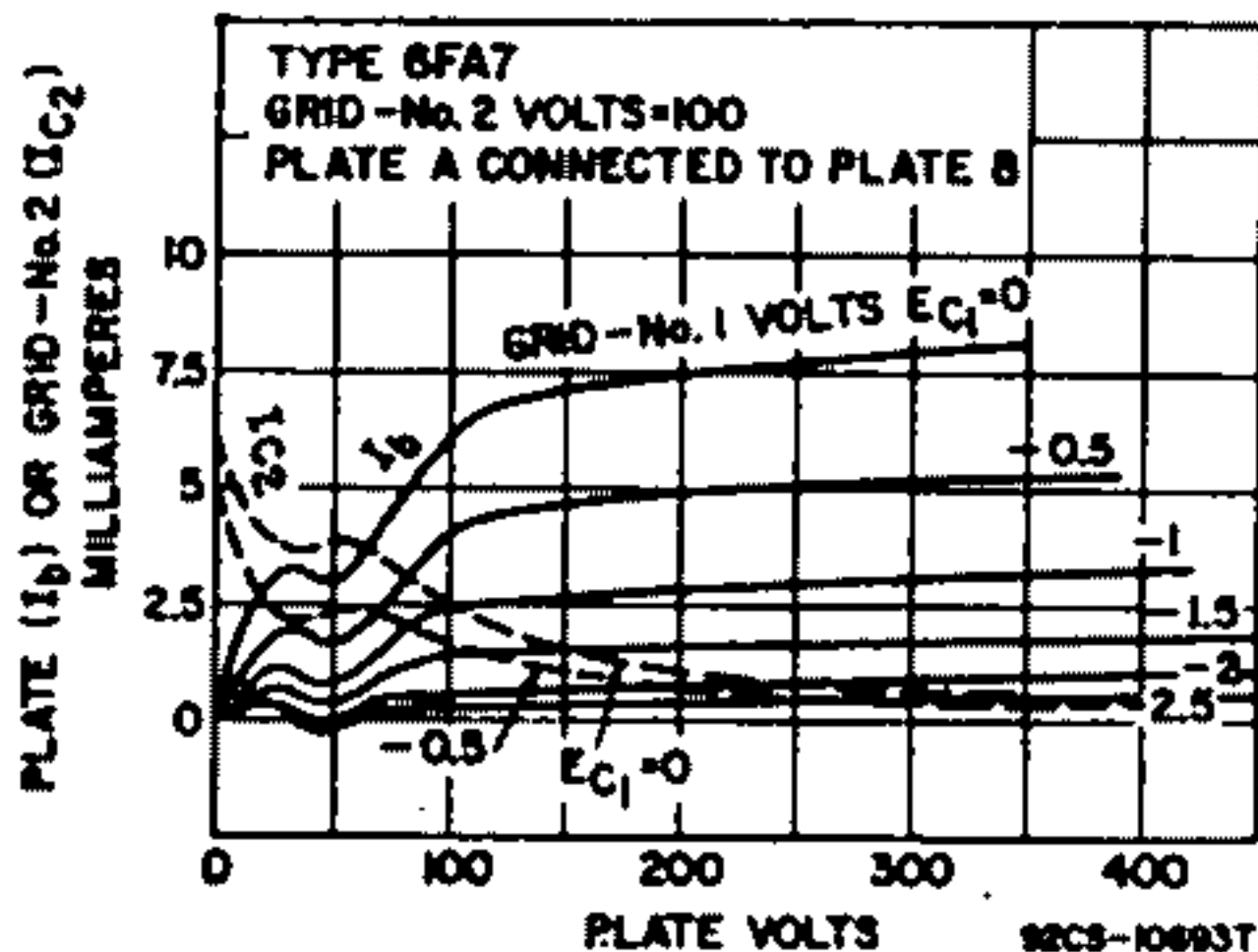
Diode Unit

**MAXIMUM RATINGS (Design-Maximum Values)**

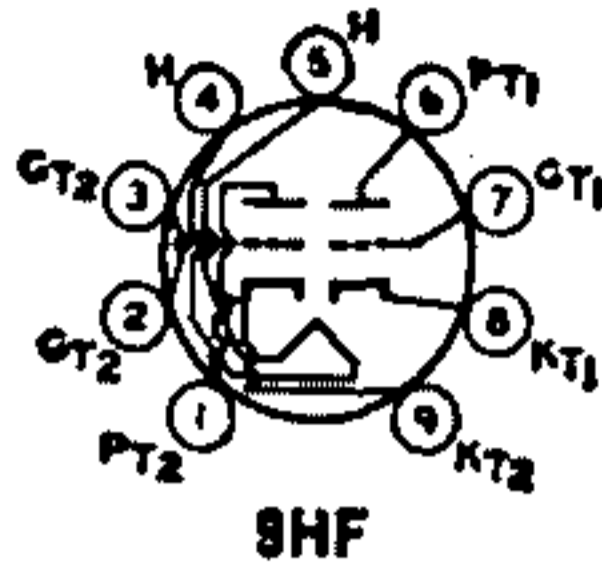
Plate Current .....	1	mA
---------------------	---	----

**CHARACTERISTICS, instantaneous Value**

Tube Voltage Drop for plate current of 2 mA .....	10	volts
---	----	-------







**DUAL TRIODE**

**6FD7**  
13FD7

Glass type containing high-mu and low-mu triode units used as combined vertical-deflection oscillator and vertical-deflection amplifier in television receivers. Outlines section, 10B; requires miniature 9-contact socket. Type 13FD7 is identical with type 6FD7 except for heater ratings.

	6FD7	13FD7	
Heater Voltage (ac/dc)	6.3	13	volts
Heater Current	0.925	0.45	ampere
Heater Warm-up Time (Average)	—	11	seconds
Heater-Cathode Voltage:			
Peak value	±200 max	±200 max	volts
Average value	100 max	100 max	volts
Direct Interelectrode Capacitances (Approx.):	Unit No.1	Unit No.2	
Grid to Plate	4.5	10	pF
Grid to Cathode and Heater	2.2	6.6	pF
Plate to Cathode and Heater	0.4	0.2	pF

**Class A<sub>1</sub> Amplifier**

CHARACTERISTICS	Unit No.1	Unit No.2	
Plate Voltage	250	60 150	volts
Grid Voltage	—3	0 —17.5	volts
Amplification Factor	64	— 6	
Plate Resistance (Approx.)	4000	— 800	ohms
Transconductance	1600	— 7500	μmhos
Plate Current	1.5	95* 40	mA
Grid Voltage (Approx.):			
For plate current of 10 μA	—5.5	— —	volts
For plate current of 100 μA	— —	— —40	volts
Transconductance, For plate current of 1 mA	— —	— 600	μmhos
Plate Current, For grid voltage of —25 volts	— —	— 6	mA

\* This value can be measured by a method involving a recurrent waveform such that the maximum ratings of the tube will not be exceeded.

**Vertical-Deflection Oscillator and Amplifier**

For operation in a 525-line, 30-frame system

	Unit No.1 Oscillator	Unit No.2 Amplifier	
<b>MAXIMUM RATINGS (Design-Maximum Values)</b>			
DC Plate Voltage	330	330	volts
Peak Positive-Pulse Plate Voltage†	—	1500	volts
Peak Negative-Pulse Grid Voltage	—400	—250	volts
Peak Cathode Current	70	175	mA
Average Cathode Current	20	50	mA
Plate Dissipation	1.5	10	watts

**MAXIMUM CIRCUIT VALUES**

Grid-Circuit Resistance:			
For grid-resistor-bias or cathode-bias operation	2.2	2.2	megohms

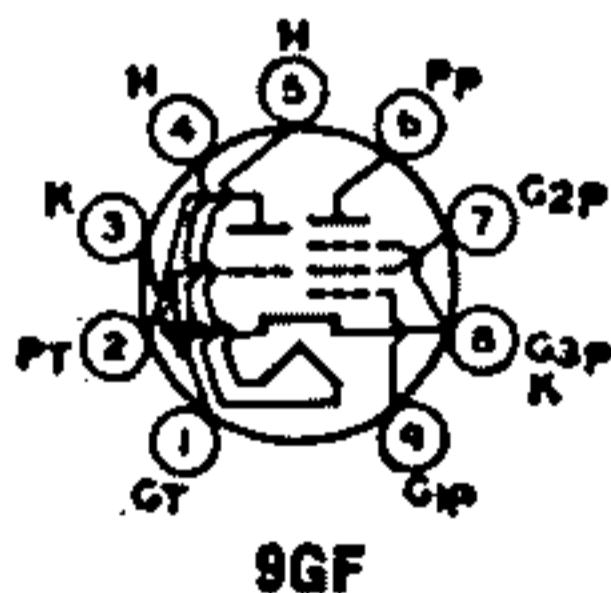
† Pulse duration must not exceed 15% of a vertical scanning cycle (2.5 milliseconds).

Refer to chart at end of section.

**6FE5**

Refer to chart at end of section.

**6FG6**



**SHARP-CUTOFF PENTODE  
MEDIUM-MU TRIODE—**

**6FG7**  
5FG7

Miniature type used as combined oscillator and mixer tube in vhf color and black-and-white television receivers. Outlines section, 6B; requires miniature 9-contact socket. Type 5FG7 is identical with type 6FG7 except for heater ratings.

	5FG7	6FG7	
Heater Voltage (ac/dc)	4.7	6.8	volts
Heater Current	0.6	0.45	ampere
Heater Warm-up Time (Average)	11	11	seconds

<b>Heater-Cathode Voltage:</b>			
Peak value .....	±200 max	±200 max	volts
Average value .....	100 max	100 max	volts
<b>Direct Interelectrode Capacitances:</b>			
<b>Triode Unit:</b>			
Grid to Plate .....	1.8	1.8	pF
Grid to Cathode, Pentode Grid No.3, and Heater .....	3	3	pF
Plate to Cathode, Pentode Grid No.3, and Heater .....	1.8	1.9	pF
<b>Pentode Unit:</b>			
Grid No.1 to Plate .....	0.02 max	0.01 max	pF
Grid No.1 to Cathode, Grid No.3, Grid No.2, and Heater .....	5	5	pF
Plate to Cathode, Grid No.3, Grid No.2, and Heater .....	2.4	3.4	pF
Heater to Cathode, and Pentode Grid No.3 .....	6	6*	pF

\* With external shield connected to cathode except as noted.  
 \* With external shield connected to ground.

**Class A<sub>1</sub> Amplifier**

<b>MAXIMUM RATINGS (Design-Maximum Values)</b>			
Plate Voltage .....	330	330	volts
Grid-No.2 (Screen-Grid) Supply Voltage .....	—	330	volts
Grid-No.2 Voltage .....	—	See curve page 96	
Grid-No.1 (Control-Grid) Voltage, Positive-bias value .....	0	0	volts
Plate Dissipation .....	2.5	3	watts
<b>Grid-No.2 Input:</b>			
For grid-No.2 voltages up to 165 volts .....	—	See curve page 96	
For grid-No.2 voltages between 165 and 330 volts .....	—	0.55	watt

**CHARACTERISTICS**

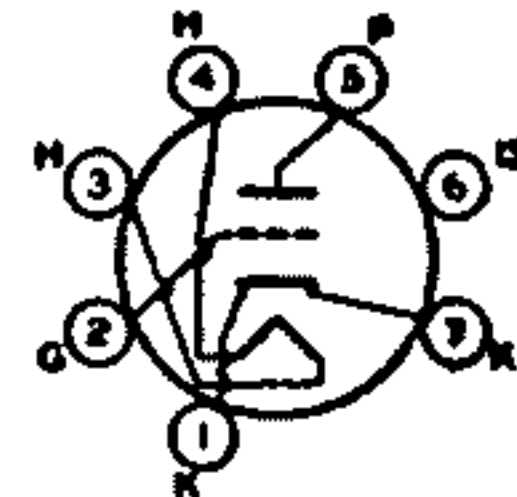
	<b>Triode Unit</b>	<b>Pentode Unit</b>	
Plate Voltage .....	125	100 125	volts
Grid-No.2 Voltage .....	—	100 125	volts
Grid-No.1 Voltage .....	-1	0 -1	volts
Amplification Factor .....	43	—	
Plate Resistance (Approx.) .....	5700	— 180000	ohms
Transconductance .....	7500	7400 6000	μmhos
Plate Current .....	18	— 11	mA
Grid-No.2 Current .....	—	— 4	mA
Grid-No.1 Voltage (Approx.) for plate current of 30 μA .....	-6.5	— -7.5	volts

**6FH5**

2FH5, 3FH5

**HIGH-MU TRIODE**

Miniature type used as an rf amplifier in vhf tuners, of color and black-and-white television receivers. Outlines section, 5C; requires 7-contact socket. Types 2FH5 and 3FH5 are identical with type 6FH5 except for heater ratings.

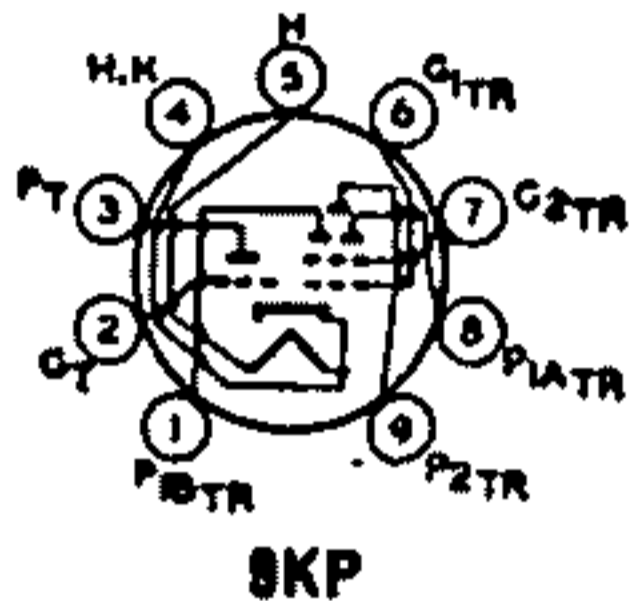
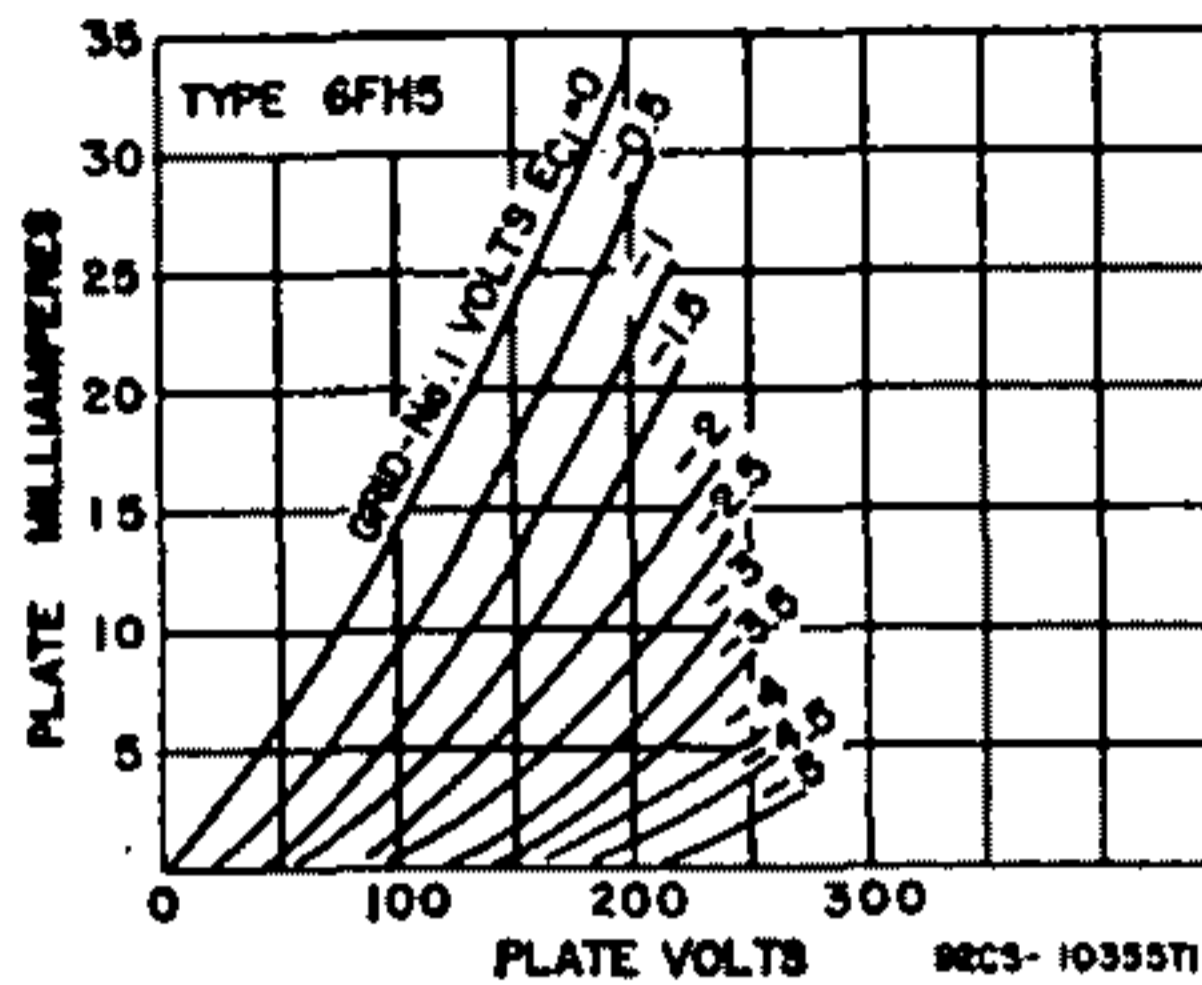


96F

	<b>2FH5</b>	<b>3FH5</b>	<b>6FH5</b>	
Heater Voltage (ac/dc) .....	2.35	3	6.3	volts
Heater Current .....	0.6	0.45	0.2	ampere
Heater Warm-up Time (Average) .....	11	11	—	seconds
Peak Heater-Cathode Voltage .....	±100 max	±100 max	±100 max	volts
<b>Direct Interelectrode Capacitances (Approx.):</b>				
	<b>Unshielded</b>	<b>Shielded*</b>		
Grid to Plate .....	0.52	0.52		pF
Grid to Cathode, Heater, and Internal Shield ..	3.2	3.2		pF
Plate to Cathode, Heater, and Internal Shield ..	3.2	4		pF

**Class A<sub>1</sub> Amplifier**

<b>MAXIMUM RATINGS (Design-Maximum Values)</b>			
Plate Voltage .....		150	volts
Grid Voltage, Positive-bias value .....		0	volts
Cathode Current .....		22	mA
Plate Dissipation .....		2.2	watts
<b>CHARACTERISTICS</b>			
Plate Voltage .....		135	volts
Grid Voltage .....		-1	volts
Plate Resistance (Approx.) .....		5600	ohms
Transconductance .....		9000	μmhos
Plate Current .....		11	mA
Grid Voltage (Approx.) for plate current of 100 μA .....		-5.5	volts
<b>MAXIMUM CIRCUIT VALUE</b>			
Grid-Circuit Resistance, For cathode-bias operation .....		1	megohm



**MEDIUM-MU TRIODE—  
THREE-PLATE TETRODE** **6FH8**

Miniature type used in complex-wave generator applications and in television receiver applications. Sharp-cutoff tetrode unit has pair of additional plates. Outlines section, 6B; requires 9-contact socket.

Heater Voltage (ac/dc)	6.3	volts
Heater Current	0.45	ampere
Direct Interelectrode Capacitances: <sup>*</sup>		
Triode Unit:		
Grid to Plate	1.4	pF
Grid to Cathode and Heater	2.6	pF
Plate to Cathode and Heater	1	pF
Tetrode Unit:		
Grid No.1 to Plate No.2	0.08 max	pF
Grid No.1 to Cathode, Heater, Grid No.2, Plate No.1A, and Plate No.1B	4.5	pF
Plate No.2 to Cathode, Heater, Grid No.2, Plate No.1A, and Plate No.1B	1.4	pF
Tetrode Grid No.1 to Triode Plate	0.35 max	pF
Tetrode Plate No.2 to Triode Plate	0.008 max	pF

\* With external shield connected to cathode.

**Class A<sub>1</sub> Amplifier**

Triode Unit		
<b>CHARACTERISTICS</b>		
Plate Voltage	100	volts
Grid Voltage	-1	volt
Amplification Factor	40	
Plate Resistance (Approx.)	7400	ohms
Transconductance	5400	μmhos
Plate Current	7.9	mA
Grid Voltage (Approx.) for plate current of 100 μA	-7	volts

Tetrode Unit with Plates No.1A and No.1B Connected to Cathode at Socket

<b>MAXIMUM RATINGS (Design-Maximum Values)</b>		
Plate-No.2 Voltage	250	volts
Grid-No.2 Voltage	250	volts
Grid-No.1 Voltage	-2	volts
Plate-No.2 Resistance (Approx.)	0.75	megohm
Transconductance, Grid No.1 to Plate No.2	4400	μmhos
Plate-No.2 Current	7.8	mA
Grid-No.2 Current	1.4	mA
Grid-No.1 Voltage (Approx.) for plate-No.2 current of 100 μA	-7	volts

**Complex-Wave Generator**

<b>MAXIMUM RATINGS (Design-Maximum Values)</b>			
	Triode Unit	Tetrode Unit	
Plate Voltage	275	—	volts
Plate-No.1A Voltage	—	200	volts
Plate-No.1B Voltage	—	200	volts
Plate-No.2 Voltage	—	275	volts



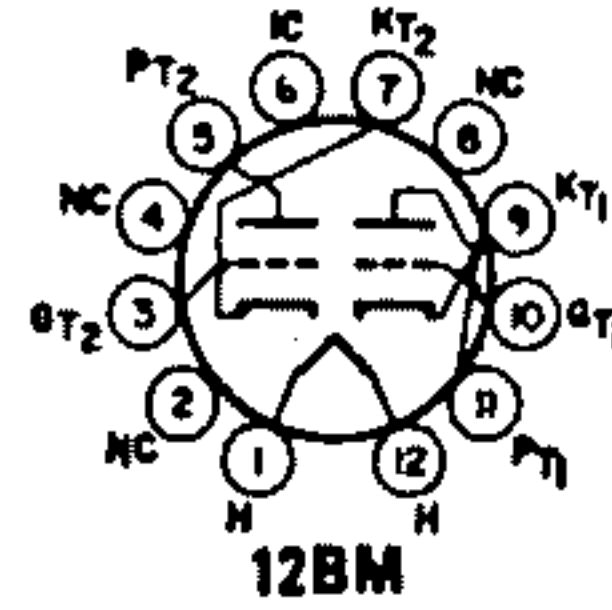
	Triode Unit	Tetrode Unit	
Grid-No.2 (Screen-Grid) Supply Voltage	—	275	volts
Grid-No.2 Voltage	—	See curve page 96	
Grid-No.1 (Control-Grid) Voltage:			
Negative-bias value	-40	-40	volts
Positive-bias value	0	0	volts
Plate Dissipation	1.7	—	watts
Plate-No.1A Dissipation	—	0.8	watt
Plate-No.1B Dissipation	—	0.8	watt
Plate-No.2 Dissipation	—	2.3	watts
Grid-No.2 Input:			
For grid-No.2 voltages up to 187.5 volts	—	0.45	watt
For grid-No.2 voltages between 187.5 and 275 volts	—	See curve page 96	

	Tetrode Unit	
<b>TYPICAL OPERATION WITH SEPARATE PLATE OPERATION</b>		
Plates-No.1A, No.1B, and No.2 Voltage	100	volts
Grid-No.2 Voltage	50	volts
Grid-No.1 Voltage	-1	volts
Plate-No.1A Current	0.04	mA
Plate-No.1B Current	0.04	mA
Plate-No.2 Current	1.6	mA
Grid-No.2 Current	0.3	mA
Transconductance (Approx.):		
Grid No.1 to Plate No.1A	70	μmhos
Grid No.1 to Plate No.1B	70	μmhos
Grid No.1 to Plate No.2	2500	μmhos

	Triode Unit	Tetrode Unit	
<b>MAXIMUM CIRCUIT VALUES</b>			
Grid-No.1-Circuit Resistance, for fixed-bias operation	0.5	0.5	megohms

## 6FJ7 MEDIUM-MU DUAL TRIODE

Duodecar type used as combined vertical-deflection-oscillator and vertical-deflection-amplifier tube in color and black-and-white television receivers. Outlines section, 8B; requires duodecar 12-contact socket. Heater: volts (ac/dc), 6.3; amperes, 0.9; maximum heater-cathode volts, ±200 peak, 100 average.



### Class A<sub>1</sub> Amplifier

CHARACTERISTICS	Unit No.1	Unit No.2	
Plate Voltage	250	150	250
Grid Voltage	-8	0	-9.5
Amplification Factor	22.5	—	15.4
Plate Resistance (Approx.)	9000	—	2000
Transconductance	2500	—	7700
Plate Current	8	68*	41
Grid Voltage (Approx.) for plate current of 10 μA	-18	—	—
Grid Voltage (Approx.) for plate current of 50 μA	—	—	-23

\* This value can be measured by a method involving a recurrent waveform such that the maximum ratings of the tube will not be exceeded.

### Vertical-Deflection Oscillator and Amplifier

For operation in a 525-line, 30-frame system

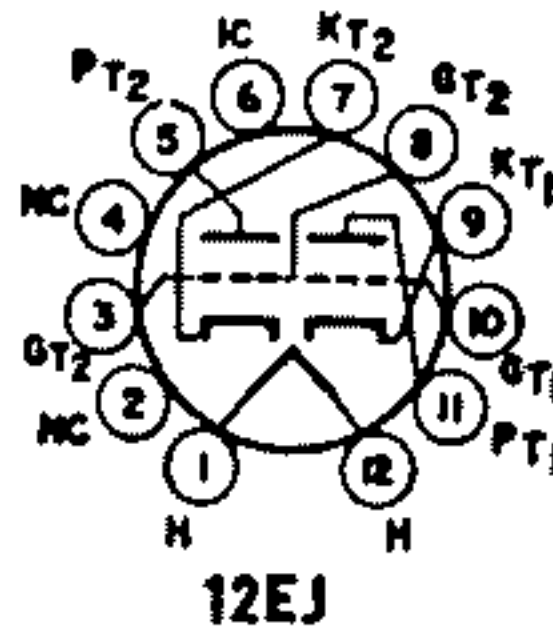
MAXIMUM RATINGS (Design-Maximum Values)	Unit No.1 Oscillator	Unit No.2 Amplifier	
DC Plate Voltage	350	550	volts
Peak Positive-Pulse Plate Voltage*	—	2500	volts
Peak Negative-Pulse Grid Voltage	-400	-250	volts
Peak Cathode Current	—	150	mA
Average Cathode Current	—	50	mA
Plate Dissipation	1	10	watts
<b>MAXIMUM CIRCUIT VALUES</b>			
Grid-Circuit Resistance:			
For fixed-bias operation	2.2	2.2	megohms
For cathode-bias operation	2.2	—	megohms

\* Pulse duration must not exceed 15% of a vertical scanning cycle (2.5 milliseconds).

# 6FM7

13FM7, 15FM7

## DUAL TRIODE



Duodecar type used as combined vertical-deflection oscillator and vertical-deflection amplifier in color and black-and-white television receivers. Triode unit No.1 is used as an oscillator, and triode unit No.2 is used as an amplifier. Outlines section, 8C; requires duodecar 12-contact socket. Types 13FM7 and 15FM7 are identical with type 6FM7 except for heater ratings.

	6FM7	13FM7	15FM7	
Heater Voltage (ac/dc)	6.3	13	14.8	volts
Heater Current	1.05	0.45	0.45	amperes
Heater Warm-up Time (Average)	—	11	11	seconds
Heater-Cathode Voltage:				
Average value	±200 max	±200 max	±200 max	volts
Peak value	100 max	100 max	100 max	volts

### Class A<sub>1</sub> Amplifier

CHARACTERISTICS	Unit No.1	Unit No.2	
Plate Voltage	250	175	volts
Grid Voltage	-3	-25	volts
Amplification Factor	66	5.5	
Plate Resistance (Approx.)	30000	920	ohms
Transconductance	2200	6000	μmhos
Plate Current	2	40	mA
Grid Voltage (Approx.) for plate current of 20 μA	-5.3	—	volts
Grid Voltage (Approx.) for plate current of 200 μA	—	-45	volts

### Vertical-Deflection Oscillator and Amplifier

For operation in a 525-line, 30-frame system

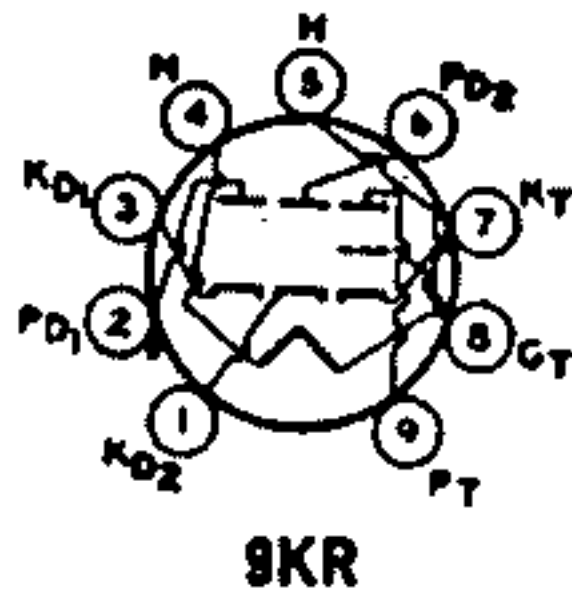
MAXIMUM RATINGS (Design-Maximum Values)			
DC Plate Voltage	350	550	volts
Peak Positive-Pulse Plate Voltage <sup>#</sup>	—	1500	volts
Peak Negative-Pulse Plate Voltage	-400	-250	volts
Peak Cathode Current	—	175	mA
Average Cathode Current	—	50	mA
Plate Dissipation <sup>†</sup>	1	10	watts

#### MAXIMUM CIRCUIT VALUES

Grid-Circuit Resistance:			
For fixed-bias operation	1	1	megohm
For cathode-bias operation	2.2	2.2	megohms

<sup>#</sup> Pulse duration must not exceed 15% of a vertical scanning cycle (2.5 milliseconds).

<sup>†</sup> A bias resistor or other means is required to protect the tube in absence of excitation.



## TWIN DIODE— HIGH-MU TRIODE

# 6FM8

Miniature type used in television receiver applications and as combined FM detector and af voltage amplifier in FM receivers. Outlines section, 6B; requires miniature 9-contact socket. Heater: volts (ac/dc), 6.3; amperes, 0.45; maximum heater-cathode volts, ±200 peak, 100 average.

### Triode Unit as Class A<sub>1</sub> Amplifier

MAXIMUM RATINGS (Design-Maximum Values)			
Plate Voltage	330		volts
Grid Voltage, Positive-bias value	0		volts
Plate Dissipation	1.1		watts
CHARACTERISTICS			
Plate Voltage	250		volts
Grid Voltage	-3		volts
Amplification Factor	70		
Plate Resistance (Approx.)	58000		ohms
Transconductance	1200		μmhos
Plate Current	1		mA

Diode Units (Each Unit)

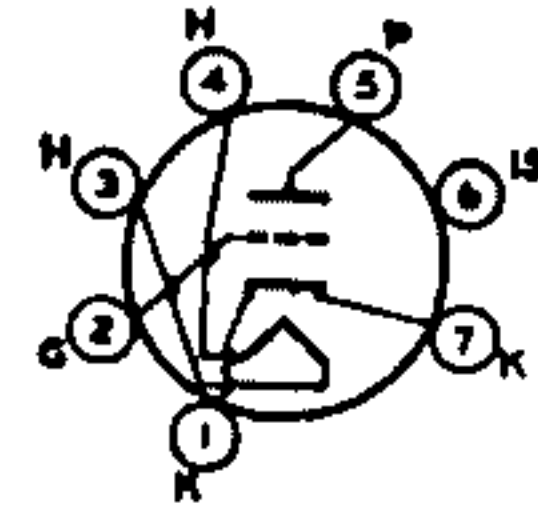
<b>MAXIMUM RATINGS (Design-Maximum Values)</b>		
Plate Current .....	5	mA
<b>CHARACTERISTICS, Instantaneous Value</b>		
Tube Voltage Drop for plate current of 20 mA .....	5	volts

**6FQ5A**

2FQ5A

**HIGH-MU TRIODE**

Miniature type with frame grid used as rf-amplifier tube in vhf tuners of television receivers. Outlines section, 5C; requires miniature 7-contact socket. Type 2FQ5A is identical with type 6FQ5A except for heater ratings.



7FP

Heater Voltage (ac/dc) .....	2FQ5A	6FQ5A	
Heater Current .....	2.3	6.3	volts
Heater Warm-up Time (Average) .....	0.6	0.18	ampere
Peak Heater-Cathode Voltage .....	11	—	seconds
Direct Interelectrode Capacitances:*	±100 max	±100 max	volts
Grid to Plate .....		0.52	pF
Grid to Cathode, Heater, and Internal Shield .....		5	pF
Plate to Cathode, Heater, and Internal Shield .....		3.5	pF
Heater to Cathode .....		2.5	pF

\* With external shield connected to cathode except as noted.

**Class A<sub>1</sub> Amplifier**

<b>MAXIMUM RATINGS (Design-Maximum Values)</b>		
Plate Voltage .....	200	volts
Grid Voltage, Negative-bias value .....	-50	volts
Average Cathode Current .....	22	mA
Plate Dissipation .....	2.5	watts
<b>CHARACTERISTICS</b>		
Plate Voltage .....	185	volts
Grid Voltage .....	-1.2	volts
Amplification Factor .....	74	
Plate Resistance (Approx.) .....	6800	ohms
Transconductance .....	12000	μmhos
Plate Current .....	8.9	mA
Grid Voltage (Approx.) for plate current of 100 μA .....	-4.5	volts
<b>MAXIMUM CIRCUIT VALUE</b>		
Grid-Circuit Resistance, for cathode-bias operation .....	1	megohm

**6FQ7**

Refer to chart at end of section.

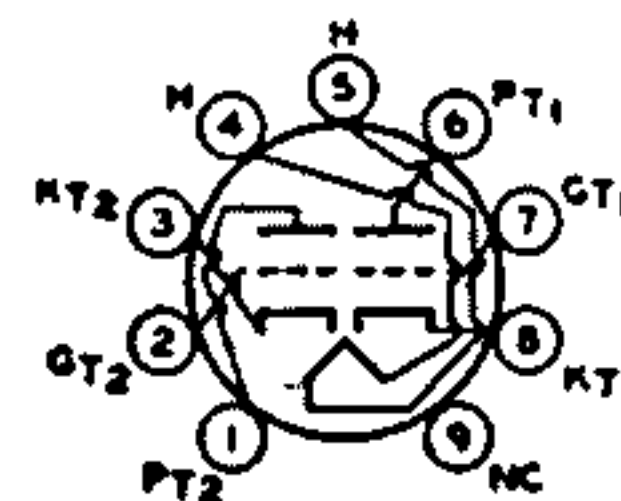
**6FQ7/**

**6CG7**

8FQ7/8CG7

**MEDIUM-MU TWIN TRIODE**

Miniature type used as combined vertical- and horizontal-deflection oscillator in color and black-and-white television receivers. Outlines section, 6E; requires miniature 9-contact socket. Type 8FQ7/8CG7 is identical with type 6FQ7/6CG7 except for heater ratings. For typical operation as a resistance-coupled amplifier, refer to Resistance-Coupled Amplifier section.



9LP

Heater Voltage (ac/dc) .....	6FQ7/6CG7	8FQ7/8CG7	
Heater Current .....	6.3	8.4	volts
Heater Warm-up Time (Average) .....	0.6	0.45	ampere
Heater-Cathode Voltage:			seconds
Peak value .....	±200 max	±200 max	volts
Average value .....	100 max	100 max	volts
Direct Interelectrode Capacitances (Approx.):	Unit No.1	Unit No.2	
Grid to Plate .....	8.6	8.8	pF
Grid to Cathode and Heater .....	2.4	2.4	pF



Plate to Cathode and Heater .....	0.84	0.26	pF
Plate of Unit No.1 to Plate of Unit No.2 .....	1		pF

**MAXIMUM RATINGS (Design-Maximum Values)**

Plate Voltage .....	330	volts
Grid Voltage, Positive-bias value .....	0	volts
Cathode Current .....	22	mA
Plate Dissipation:		
For either plate .....	4	watts
For both plates with both units operating .....	5.7	watts

**CHARACTERISTICS**

Plate Voltage .....	90	250	volts
Grid Voltage .....	0	-8	volts
Amplification Factor .....	20	20	
Plate Resistance (Approx.) .....	6700	7700	ohms
Transconductance .....	3000	2600	μmhos
Plate Current .....	10	9	mA
Grid Voltage (Approx.) for plate current of 10 μA .....	-7	-18	volts
Plate Current for grid voltage of -12.5 volts .....	—	1.3	mA

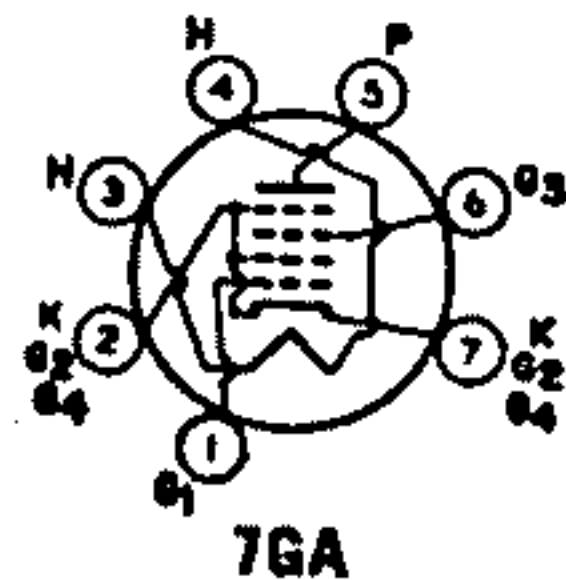
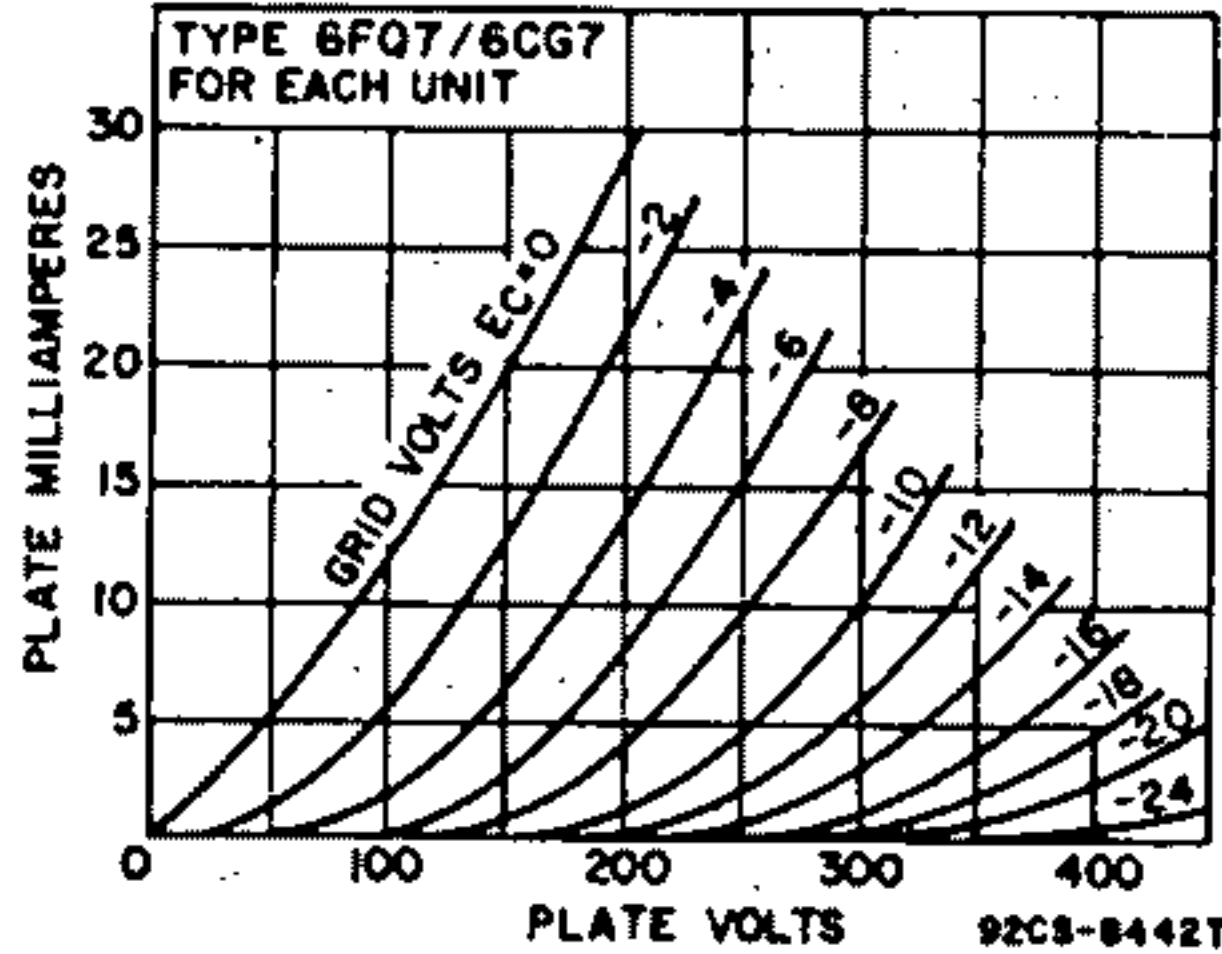
**MAXIMUM CIRCUIT VALUE**

Grid Circuit Resistance, For fixed-bias operation .....	1.0	megohm
---	-----	--------

**Oscillator**

For operation in a 525-line, 30-frame system

	Vertical-Deflection Oscillator	Horizontal-Deflection Oscillator	
<b>MAXIMUM RATINGS (Design-Maximum Values)</b>			
DC Plate Voltage .....	330	330	volts
Peak Negative-Pulse Grid Voltage .....	-440	-660	volts
Peak Cathode Current .....	77	830	mA
Average Cathode Current .....	22	22	mA
Plate Dissipation:			
For either plate .....	4	4	watts
For both plates with both units operating .....	5.7	5.7	watts
<b>MAXIMUM CIRCUIT VALUE</b>			
Grid-Circuit Resistance .....	2.2	2.2	megohms



**BEAM HEXODE**

Miniature type used as rf-amplifier tube in vhf television receivers. In this tube, grid No.1 is the control grid, grid No.2 is a focusing grid, grid No.3 is the screen grid, and grid No.4 is the suppressor grid. Grid No.2 is internally connected to the cathode and grid No.4 and aligned with grid No.3. Outlines section, 5C; requires miniature 7-contact socket. Types 2FS5 and 3FS5 are identical with type 6FS5 except for heater ratings.

**6FS5**

2FS5, 3FS5

	2FS5	3FS5	6FS5	
Heater Voltage (ac/dc) .....	2.4	2.9	6.3	volts
Heater Current .....	0.6	0.45	0.2	ampere
Heater Warm-up Time (Average) .....	11	11	—	seconds

<b>Heater-Cathode Voltage:</b>				
Peak value .....	±200 max	±200 max	±200 max	volts
Average value .....	100 max	100 max	100 max	volts
<b>Direct Interelectrode Capacitances:</b>				
Grid No.1 to Plate .....	Shielded	Unshielded*		pF
Grid No.1 to Cathode, Heater, Grid No.2, Grid No.3, and Grid No.4 .....	0.03	0.018		
Plate to Cathode, Heater, Grid No.2, Grid No.3, and Grid No.4 .....	4.8	4.8		pF
	2	2.8		pF

\* With external shield connected to pin 7.

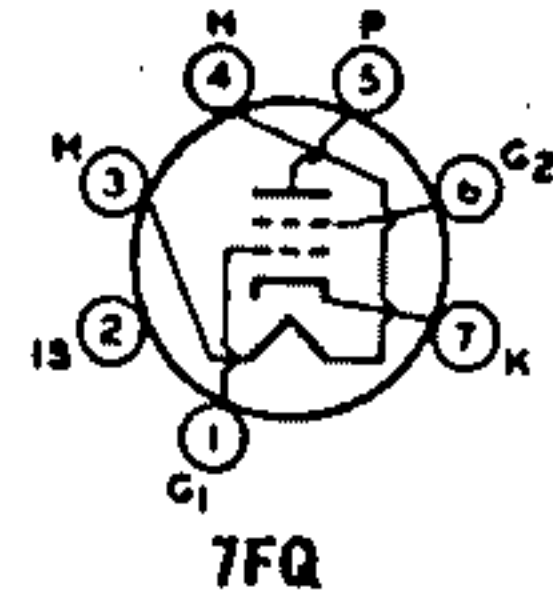
**Class A<sub>1</sub> Amplifier**

<b>MAXIMUM RATINGS (Design-Maximum Values)</b>		
Plate Voltage .....	300	volts
Grid-No.3 (Screen-Grid) Voltage .....	150	volts
Grid-No.1 (Control-Grid) Voltage:		
Negative-bias value .....	-50	volts
Positive-bias value .....	0	volts
Cathode Current .....	20	mA
Plate Dissipation .....	3.25	watts
Grid-No.3 Input .....	0.15	watt
<b>CHARACTERISTICS</b>		
Plate Voltage .....	275	volts
Grid-No.3 Voltage .....	136	volts
Grid-No.1 Voltage .....	-0.2	volt
Plate Resistance (Approx.) .....	0.24	megohm
Transconductance .....	10000	μmbos
Plate Current .....	9	mA
Grid-No.3 Current .....	0.17	mA
Grid-No.1 Voltage (Approx.) for transconductance of 100 μmbos ...	-6	volts
<b>MAXIMUM CIRCUIT VALUE</b>		
Grid-No.1-Circuit Resistance, For fixed-bias operation .....	0.5	megohm

**6FV6**

**SHARP-CUTOFF TETRODE**

Miniature type used as rf amplifier in vhf tuners of television receivers. Outlines section, 5C; requires 7-contact socket.



Heater Voltage (ac/dc) .....	6.3	volts
Heater Current .....	0.2	ampere
<b>Heater-Cathode Voltage:</b>		
Peak value .....	±200 max	volts
Average value .....	100 max	volts
<b>Direct Interelectrode Capacitances:*</b>		
Grid No.1 to Plate .....	0.08 max	pF
Grid No.1 to Cathode, Heater, Grid No.2, and Internal Shield ..	4.5	pF
Plate to Cathode, Heater, Grid No.2, and Internal Shield .....	3	pF
Cathode to Heater .....	2.7*	pF

\* With external shield connected to cathode except as noted.  
 \* With external shield connected to ground.

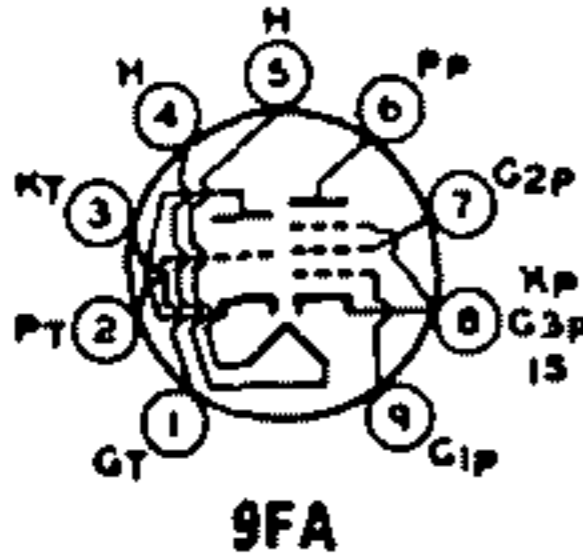
**Class A<sub>1</sub> Amplifier**

<b>MAXIMUM RATINGS (Design-Maximum Values)</b>		
Plate Voltage .....	275	volts
Grid-No.2 (Screen-Grid) Supply Voltage .....	180	volts
Grid-No.2 Voltage .....	See curve page 96	
Grid-No.1 (Control-Grid) Voltage, Positive-bias value .....	0	volts
Cathode Current .....	20	mA
Plate Dissipation .....	2	watts
Grid-No.2 Input:		
For grid-No.2 voltages up to 90 volts .....	0.5	watt
For grid-No.2 voltages between 90 and 180 volts .....	See curve page 96	
<b>CHARACTERISTICS</b>		
Plate Voltage .....	125	volts
Grid-No.2 Voltage .....	80	volts
Grid-No.1 Voltage .....	-1	volt
Plate Resistance (Approx.) .....	0.1	megohm
Transconductance .....	8000	μmbos
Plate Current .....	10	mA

Grid-No.2 Current .....	1.5	mA
Grid-No.1 Voltage (Approx.) for plate current of 20 $\mu$ A .....	-6	volts
<b>MAXIMUM CIRCUIT VALUE</b>		
Grid-No.1-Circuit Resistance .....	0.5	megohms

Refer to chart at end of section.

6FV8



9FA

**MEDIUM-MU TRIODE—  
SHARP-CUTOFF PENTODE**

**6FV8A  
5FV8**

Miniature type used in television receivers as combined oscillator and amplifier. Triode unit is used as vertical-deflection oscillator; pentode unit is used as if or general-purpose amplifier. Outlines section, 6B; requires 9-contact socket. Type 5FV8 is identical with type 6FV8A except for heater ratings.

Heater Voltage (ac/dc) .....	5FV8	6FV8A	
Heater Current .....	4.7	6.3	volts
Heater Warm-up Time (Average) .....	0.6	0.45	ampere
Heater-Cathode Voltage:	11	11	seconds
Peak value .....	$\pm 200$ max	$\pm 200$ max	volts
Average value .....	100 max	100 max	volts
<b>Direct Interelectrode Capacitances:</b>			
<b>Triode Unit:</b>			
Grid to Plate .....	1.8	1.8	pF
Grid to Cathode, Heater, Pentode Cathode, Pentode Grid No.3, and Internal Shield .....	2.8	2.8	pF
Plate to Cathode, Heater, Pentode Cathode, Pentode Grid No.3, and Internal Shield .....	1.5	2	pF
<b>Pentode Unit:</b>			
Grid No.1 to Plate .....	0.02 max	0.01 max	pF
Grid No.1 to Cathode, Heater, Grid No.2, Grid No.3, and Internal Shield .....	5	5	pF
Plate to Cathode, Heater, Grid No.2, Grid No.3, and Internal Shield .....	2	3	pF
Pentode Plate to Triode Plate .....	0.15 max	0.03 max	pF

**Class A<sub>1</sub> Amplifier**

<b>MAXIMUM RATINGS (Design-Maximum Values)</b>		<b>Pentode Unit</b>	
Plate Voltage .....		300	volts
Grid-No.2 (Screen-Grid) Supply Voltage .....		300	volts
Grid-No.2 Voltage .....		See curve page 96	
Grid-No.1 (Control-Grid) Voltage, Positive-bias value .....		0	volts
Plate Dissipation .....		2.3	watts
Grid-No.2 Input:			
For grid-No.2 voltages up to 165 volts .....		0.55	watt
For grid-No.2 voltages between 165 and 330 volts .....		See curve page 96	

**MAXIMUM CIRCUIT VALUES**

<b>Grid-No.1-Circuit Resistance:</b>			
For fixed-bias operation .....		0.25	megohm
For cathode-bias operation .....		1	megohm

**CHARACTERISTICS**

	<b>Triode Unit</b>	<b>Pentode Unit</b>	
Plate Voltage .....	125	125	volts
Grid-No.2 Voltage .....	—	125	volts
Grid-No.1 Voltage .....	-1	-1	volt
Amplification Factor .....	45	—	
Plate Resistance (Approx.) .....	5600	200000	ohms
Transconductance .....	8000	6500	$\mu$ mbos
Plate Current .....	12	12	mA
Grid-No.2 Current .....	—	4	mA
Grid-No.1 Voltage (Approx.) for plate current of 20 $\mu$ A .....	-7.5	-9	volts

**Vertical-Deflection Oscillator—Triode Unit**

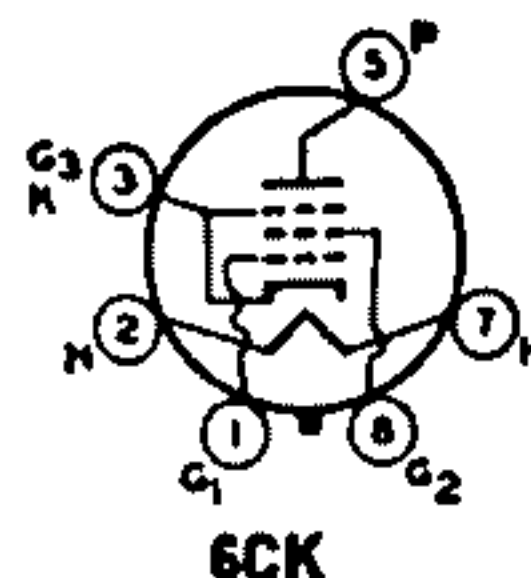
For operation in a 525-line, 30-frame system

<b>MAXIMUM RATINGS (Design-Maximum Values)</b>			
DC Plate Voltage .....		330	volts
Peak Negative-Pulse Grid Voltage .....		-250	volts
Peak Cathode Current .....		70	mA
Average Cathode Current .....		20	mA
Plate Dissipation .....		2	watts
<b>MAXIMUM CIRCUIT VALUE</b>			
Grid-Circuit Resistance, For cathode-bias operation .....		3	megohms



## 6FW5 BEAM POWER TUBE

Glass octal type used as horizontal-deflection amplifier in television receivers. Outlines section, 19B; requires octal socket. Heater: volts (ac/dc), 6.3; amperes, 1.2; maximum heater-cathode volts,  $\pm 200$  peak, 100 average.



### Horizontal-Deflection Amplifier

For operation in a 525-line, 30-frame system

#### MAXIMUM RATINGS (Design-Maximum Values)

DC Plate Voltage	770	volts
Peak Positive-Pulse Plate Voltage#	6500	volts
DC Grid-No.2 (Screen-Grid) Voltage	220	volts
Peak Negative-Pulse Grid-No.1 Voltage	-320	volts
DC Grid-No.1 (Control-Grid) Voltage	-55	volts
Peak Cathode Current	610	mA
Average Cathode Current	175	mA
Plate Dissipation*	18	watts
Grid-No.2 Input	3.6	watts
Bulb Temperature (At hottest point)	220	°C

#### MAXIMUM CIRCUIT VALUE

Grid-No.1-Circuit Resistance	1	megohm
------------------------------	---	--------

# Pulse duration must not exceed 15% of a horizontal scanning cycle (10 microseconds).

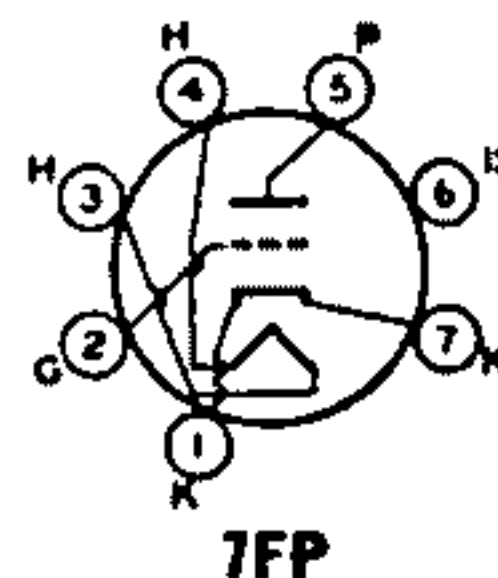
\* A bias resistor or other means is required to protect the tube in absence of excitation.

### 6FW8

Refer to chart at end of section.

## 6FY5/ EC97 HIGH-MU TRIODE

Miniature type with frame grid used for rf-amplifier applications in vhf tuners of television receivers. Outlines section, 5C; requires miniature 7-contact socket.



Heater Voltage (ac/dc)	6.3	volts
Heater Current	0.2	ampere
Peak Heater-Cathode Voltage	$\pm 100$ max	volts

#### Direct Interelectrode Capacitances:

	Unshielded	Shielded	
Grid to Plate	0.50	0.48	pF
Grid to Cathode, Heater, and Internal Shield	4.75	4.75	pF
Plate to Cathode, Heater, and Internal Shield	3.3	4.3	pF
Grid to Heater	0.28 max	0.28 max	pF
Plate to Cathode	0.25	0.21	pF
Cathode to Grid	3.2	3.2	pF
Heater to Cathode	2.5	2.5	pF

### Class A<sub>1</sub> Amplifier

#### MAXIMUM RATINGS (Absolute-Maximum Values)

Plate Supply Voltage	550	volts
Plate Voltage	200	volts
Grid Voltage, Negative-bias value	-50	volts
Cathode Current	20	mA
Plate Dissipation	2.2	watts

#### CHARACTERISTICS

Plate Voltage	135	135	135	135	volts
Grid Voltage	-1	-3.1	-5	-4.6	volts
Transconductance	18000	625	125	—	μmhos
Amplification Factor	70	—	—	—	—
Plate Current	11	—	—	0.1	mA

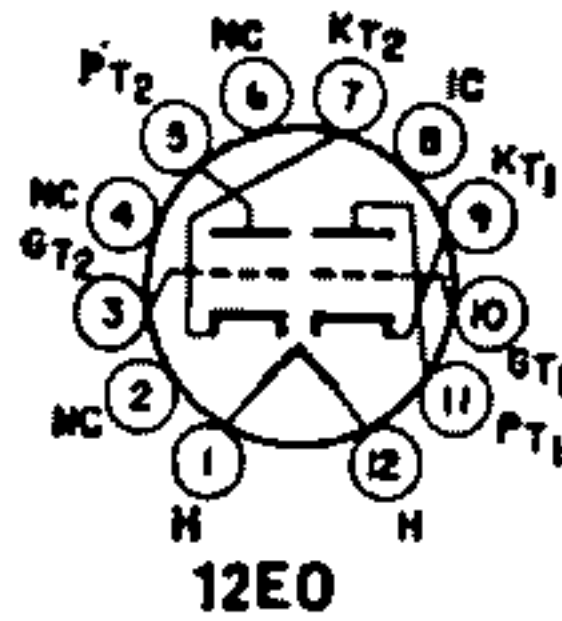
#### MAXIMUM CIRCUIT VALUES

Cathode-Heater Circuit Resistance	0.02	megohm
Grid-Circuit Resistance	1	megohm

DUAL TRIODE

6FY7

15FY7



Duodecar type used as combined vertical-deflection oscillator and vertical-deflection amplifier in television receivers. Triode unit No.1 is used as an oscillator, and triode unit No.2 is used as an amplifier. Outlines section, 8D; requires duodecar 12-contact socket. Type 15FY7 is identical with type 6FY7 except for heater ratings.

	6FY7	15FY7	
Heater Voltage (ac/dc)	6.3	14.7	volts
Heater Current	1.05	0.45	amperes
Heater Warm-up Time (Average)	—	11	seconds
Heater-Cathode Voltage:			
Peak value	±200 max	±200 max	volts
Average value	100 max	100 max	volts

Class A<sub>1</sub> Amplifier

CHARACTERISTICS	Unit No.1	Unit No.2	
Plate Voltage	250	150	volts
Grid Voltage	—3	—17.5	volts
Amplification Factor	65	6	
Plate Resistance (Approx.)	40500	920	ohms
Transconductance	1600	6500	μmhos
Plate Current	1.4	35	mA
Grid Voltage (Approx.) for plate current of 30 μA	—5.5	—	volts
Grid Voltage (Approx.) for plate current of 50 μA	—	—36	volts
Plate Current (Approx.) for grid voltage of —25 volts	—	6	mA

Vertical-Deflection Oscillator and Amplifier

For operation in a 525-line, 30-frame system

	Unit No.1 Oscillator	Unit No.2 Amplifier	
<b>MAXIMUM RATINGS (Design-Maximum Values)</b>			
DC Plate Voltage	330	275	volts
Peak Positive-Pulse Plate Voltage <sup>#</sup>	—	2000	volts
Peak Negative-Pulse Plate Voltage	—400	—250	volts
Peak Cathode Current	70	175	mA
Average Cathode Current	20	50	mA
Plate Dissipation	1	7†	watts
<b>MAXIMUM CIRCUIT VALUES</b>			
Grid-Circuit Resistance	2.2	2.2	megohms

<sup>#</sup> Pulse duration must not exceed 15% of a vertical scanning cycle (2.5 milliseconds).

† A bias resistor or other means is required to protect the tube in absence of excitation.

Refer to chart at end of section.

6G6G

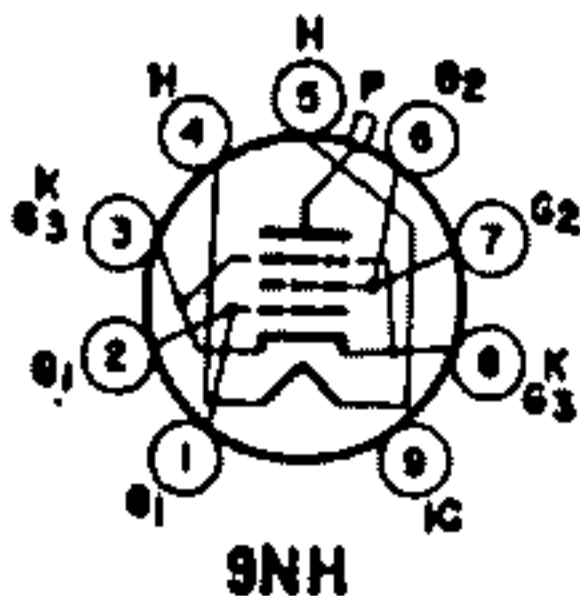
Refer to chart at end of section.

6G11

BEAM POWER TUBE

6GB5

13GB5, 27GB5/PL500



Neonovial type used as horizontal-deflection amplifier in television receivers. Outlines section, 10E; requires neonovial 9-contact socket. Typical instantaneous characteristics (measured with recurrent waveform such that maximum ratings are not exceeded): plate volts, 75; grid-No.2 volts, 200; grid-No.1 volts, —10; plate mA, 440; grid-No.2 mA, 37. Types 13GB5 and 27GB5/PL500 are identical with type 6GB5 except for heater ratings.

	6GB5	13GB5	27GB5/ PL500	
Heater Voltage (ac/dc)	6.3	13.3	27	volts
Heater Current	1.38	0.6	0.3	amperes
Heater-Cathode Voltage:				
Peak value	±250 max	±250 max	±250 max	volts
Average value	125 max	125 max	125 max	volts

**Horizontal-Deflection Amplifier**

For operation in a 525-line, 30-frame system

**MAXIMUM RATINGS (Design-Maximum Values)**

DC Grid-No.2 (Screen-Grid) Voltage .....	275	volts
Peak Positive-Pulse Plate Voltage <sup>‡</sup> .....	7700	volts
DC Grid-No.2 (Screen-Grid) Voltage .....	275	volts
Average Cathode Current .....	275	mA
Plate Dissipation <sup>‡</sup> .....	17	watts
Grid-No.2 Input <sup>*</sup> .....	5	watts

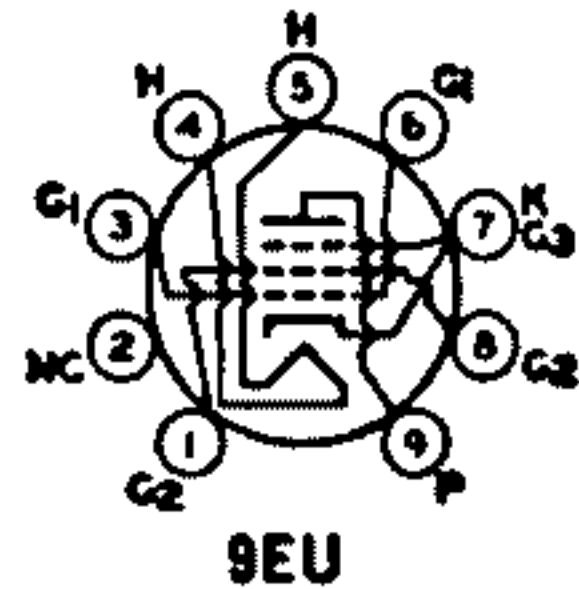
**MAXIMUM CIRCUIT VALUES**

Grid-No.1-Circuit Resistance:		
Without grid current .....	0.5	megohm
With grid current (horizontal-output service only) .....	2.2	megohms

<sup>‡</sup> Pulse duration must not exceed 15% of a horizontal scanning cycle (10 microseconds).  
<sup>‡</sup> A bias resistor or other means is required to protect the tube in absence of excitation.  
<sup>\*</sup> Grid-No.2 input may reach 6 watts for plate-dissipation values below 11 watts.

**6GC5 BEAM POWER TUBE**

Neonovial type used in color and black-and-white television receiver applications and as output tube in audio-amplifier applications. Outlines section, 10D; requires neonovial 9-contact socket.



Heater Voltage (ac/dc) .....	6.3	volts
Heater Current .....	1.2	amperes
Heater-Cathode Voltage:		
Peak value .....	±200 max	volts
Average value .....	100 max	volts
Direct Interelectrode Capacitances (Approx.):		
Grid No.1 to Plate .....	0.9	pF
Grid No.1 to Cathode, Heater, Grid No.2, and Grid No.3 .....	18	pF
Plate to Cathode, Heater, Grid No.2, and Grid No.3 .....	7	pF

**Class A<sub>1</sub> Amplifier**

**MAXIMUM RATINGS (Design-Maximum Values)**

Plate Voltage .....	220	volts
Grid-No.2 (Screen-Grid) Voltage .....	140	volts
Plate Dissipation .....	12	watts
Grid-No.2 Input .....	1.4	watts

**TYPICAL OPERATION AND CHARACTERISTICS**

Plate Voltage .....	110	200	volts
Grid-No.2 Voltage .....	110	125	volts
Grid-No.1 Voltage .....	-7.5	-	volts
Cathode-Bias Resistor .....	-	180	ohms
Peak AF Grid-No.1 Voltage .....	7.5	8.6	volts
Zero-Signal Plate Current .....	49	46	mA
Maximum-Signal Plate Current .....	50	47	mA
Zero-Signal Grid-No.2 Current .....	4	2.2	mA
Maximum-Signal Grid-No.2 Current .....	10	8.5	mA
Plate Resistance (Approx.) .....	13000	28000	ohms
Transconductance .....	8000	8000	μmhos
Load Resistance .....	2000	4000	ohms
Total Harmonic Distortion .....	10	10	per cent
Maximum-Signal Power Output .....	2.1	3.8	watts

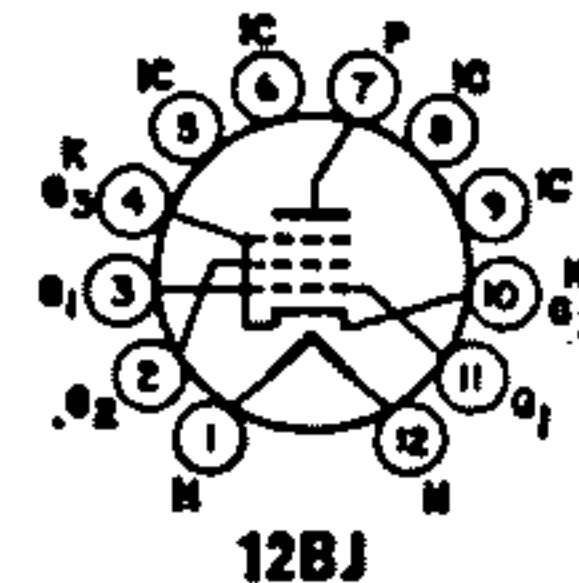
**MAXIMUM CIRCUIT VALUES**

Grid-No.1-Circuit Resistance:		
For fixed-bias operation .....	0.1	megohm
For cathode-bias operation .....	0.6	megohm

**6GE5 BEAM POWER TUBE**

12GE5, 17GE5

Duodecar type used as horizontal-deflection-amplifier tube in television receivers. Outlines section, 15A; requires duodecar 12-contact socket. Types 12GE5 and 17GE5 are identical with type 6GE5 except for heater ratings.





	6GE5	17GE5	17GE5	
Heater Voltage (ac/dc)	6.3	12.6	16.8	volts
Heater Current	1.2	0.6	0.45	amperes
Heater Warm-up Time (Average)	—	11	11	seconds
Heater-Cathode Voltage:				
Peak value	±200 max	±200 max	±200 max	volts
Average value	100 max	100 max	100 max	volts

**Class A<sub>1</sub> Amplifier**

CHARACTERISTICS	Pentode Connection	Triode* Connection	
Plate Voltage	60	250	150 volts
Grid-No.2 (Screen-Grid) Voltage	150	150	150 volts
Grid-No.1 (Control-Grid) Voltage	0	-22.5	— volts
Amplification Factor	—	—	4.4
Plate Resistance (Approx.)	—	18000	— ohms
Transconductance	—	7300	— μmhos
Plate Current	345*	65	— mA
Grid-No.2 Current	27*	1.8	— mA
Grid-No.1 Voltage (Approx.) for plate current of 1 mA	—	-42	— volts

\* Grid No.2 tied to plate.

\* This value can be measured by a method involving a recurrent waveform such that the maximum ratings of the tube will not be exceeded.

**Horizontal-Deflection Amplifier**

For operation in a 525-line, 30-frame system

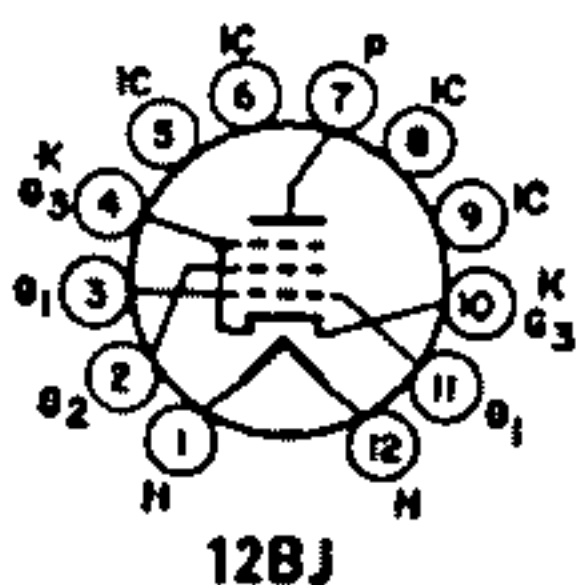
MAXIMUM RATINGS (Design-Maximum Values)		
DC Plate Supply Voltage	770	volts
Peak Positive-Pulse Plate Voltage†	6500	volts
Peak Negative-Pulse Plate Voltage	-1500	volts
DC Grid-No.2 Voltage	220	volts
Peak Negative-Pulse Grid-No.1 Voltage	-330	volts
DC Grid-No.1 Voltage	-65	volts
Peak Cathode Current	550	mA
Average Cathode Current	175	mA
Plate Dissipation†	17.5	watts
Grid-No.2 Input	3.5	watts
Bulb Temperature (At hottest point)	200	°C

**MAXIMUM CIRCUIT VALUE**

Grid-No.1 Circuit Resistance	1	megohm
------------------------------	---	--------

‡ Pulse duration must not exceed 15% of a horizontal scanning cycle (10 microseconds).

† A bias resistor or other means is required to protect the tube in absence of excitation.



**BEAM POWER TUBE**

**6GF5**

Duodecar type used as horizontal-deflection amplifier in television receivers. Outlines section, 8D; requires duodecar 12-contact socket. Heater: volts (ac/dc), 6.3; amperes, 1.2; maximum heater-cathode volts, ±200 peak, 100 average.

**Class A<sub>1</sub> Amplifier**

CHARACTERISTICS	Pentode Connection	Triode* Connection	
Plate Voltage	60	250	150 volts
Grid-No.2 (Screen-Grid) Voltage	150	150	150 volts
Grid-No.1 (Control-Grid) Voltage	0	-26.5	— volts
Amplification Factor	—	—	4.2
Plate Resistance (Approx.)	—	0.26	— megohms
Transconductance	—	4700	— μmhos
Plate Current	345*	34	— mA
Grid-No.2 Current	33*	1.6	— mA
Grid-No.1 Voltage (Approx.) for plate current of 1 mA	—	-46	— volts

\* Grid No.2 connected to plate.

\* These values can be measured by a method involving a recurrent waveform such that the maximum ratings of the tube will not be exceeded.

**Horizontal-Deflection Amplifier**

For operation in a 525-line, 30-frame system

**MAXIMUM RATINGS (Design-Maximum Values)**

DC Plate Supply Voltage	770	volts
Peak Positive-Pulse Plate Voltage <sup>‡</sup>	5000	volts
Peak Negative-Pulse Plate Voltage	-1500	volts
DC Grid-No.2 Voltage	220	volts
Peak Negative-Pulse Grid-No.1 Voltage	-330	volts
Negative DC Grid-No.1 Voltage	-55	volts
Peak Cathode Current	500	mA
Average Cathode Current	160	mA
Plate Dissipation <sup>†</sup>	9	watts
Grid-No.2 Input	2.5	watts
Bulb Temperature (At hottest point)	200	°C

**MAXIMUM CIRCUIT VALUE**

Grid-No.1-Circuit Resistance	1	megohm
------------------------------	---	--------

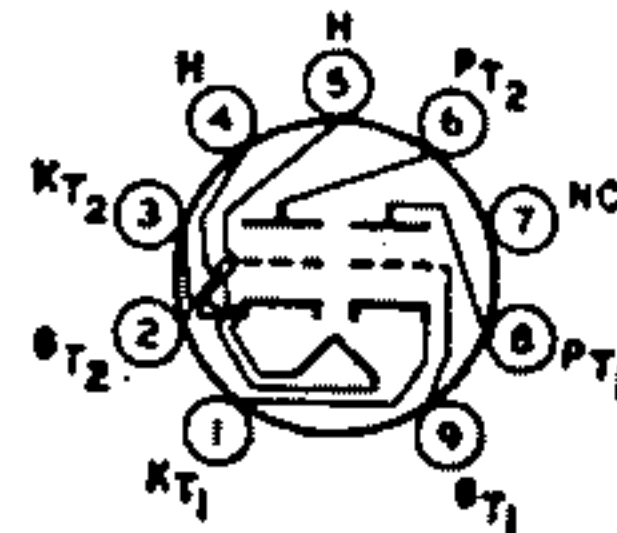
<sup>‡</sup> Pulse duration must not exceed 15% of a horizontal scanning cycle (10 microseconds).

<sup>†</sup> A bias resistor or other means is required to protect the tube in absence of excitation.

**6GF7  
6GF7A**

10GF7, 10GF7A,  
13GF7, 13GF7A

**DUAL TRIODE**



9QD

Novar types used as combined vertical-deflection oscillator and vertical-deflection amplifiers in color and black-and-white television receivers. Outlines section, 11A and 30A, respectively; require novar 9-contact socket. For curves of average plate characteristics for Unit No.1 and Unit No.2, refer to types 6DR7 (Unit No.1) and 6EM7, respectively. Types 10GF7 and 10GF7A and types 13GF7 and 13GF7A are identical with types 6GF7 and 6GF7A except for heater ratings.

	6GF7 6GF7A	10GF7 10GF7A	13GF7 13GF7A	
Heater Voltage (ac/dc)	6.3	9.7	13	volts
Heater Current	0.985	0.6	0.45	ampere
Heater Warm-up Time (Average)	—	11	11	seconds
Heater-Cathode Voltage:				
Peak value	±200 max	±200 max	±200 max	volts
Average value	100 max	100 max	100 max	volts
Direct Interelectrode Capacitances (Approx.):		Unit No.1	Unit No.2	
Grid to Plate		4.6	9	pF
Grid to Cathode and Heater		2.4	6.5	pF
Plate to Cathode and Heater		0.26	1.4	pF

**Class A<sub>1</sub> Amplifier**

CHARACTERISTICS	Unit No.1	Unit No.2	
Plate Voltage	250	150	volts
Grid Voltage	-8	-20	volts
Amplification Factor	64	5.4	
Plate Resistance (Approx.)	40000	750	ohms
Transconductance	1600	7200	amhos
Grid Voltage (Approx.):			
For plate current of 10 μA	-5.5	—	volts
For plate current of 100 μA	—	-45	volts
Plate Current	1.4	50	mA
For plate voltage of 60 volts and zero grid voltage	—	95	mA
For grid voltage of -28 volts	—	10	mA

**Vertical-Deflection Oscillator and Amplifier**

For operation in a 525-line, 30-frame system

MAXIMUM RATINGS (Design-Maximum Values)	Unit No.1 Oscillator	Unit No.2 Amplifier	
DC Plate Voltage	330	330	volts
Peak Positive-Pulse Plate Voltage	—	1500*	volts
(Absolute Maximum) <sup>‡</sup>	—	—	—
Peak Negative-Pulse Grid Voltage	-400	-250	volts
Peak Cathode Current	77	175	mA
Average Cathode Current	22	50	mA
Plate Dissipation	1.5	11	watts

**MAXIMUM CIRCUIT VALUES**

Grid-Circuit Resistance:

For grid-resistor-bias or cathode-bias operation . . . . . 2.2 . . . . . 2.2 . . . . . megohms

• Under no circumstances should this absolute value be exceeded.

‡ Pulse duration must not exceed 16% of a vertical scanning cycle (2.5 milliseconds).

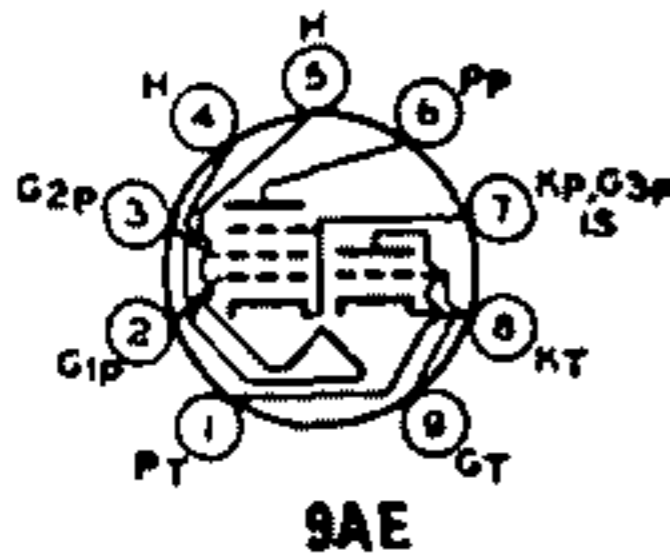
Refer to chart at end of section.

**6GH8**

**MEDIUM-MU TRIODE—  
SHARP-CUTOFF PENTODE**

**6GH8A**

5GH8A



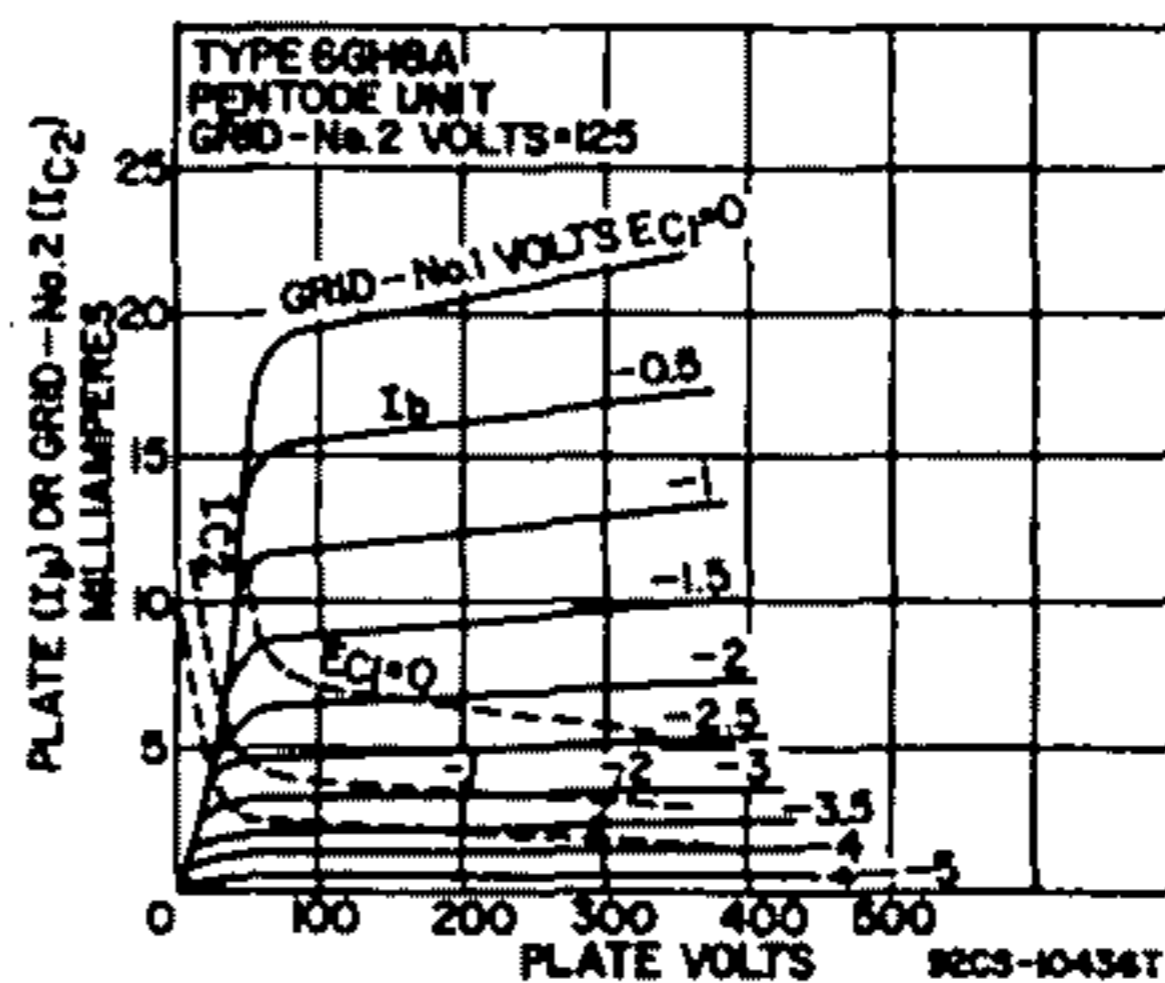
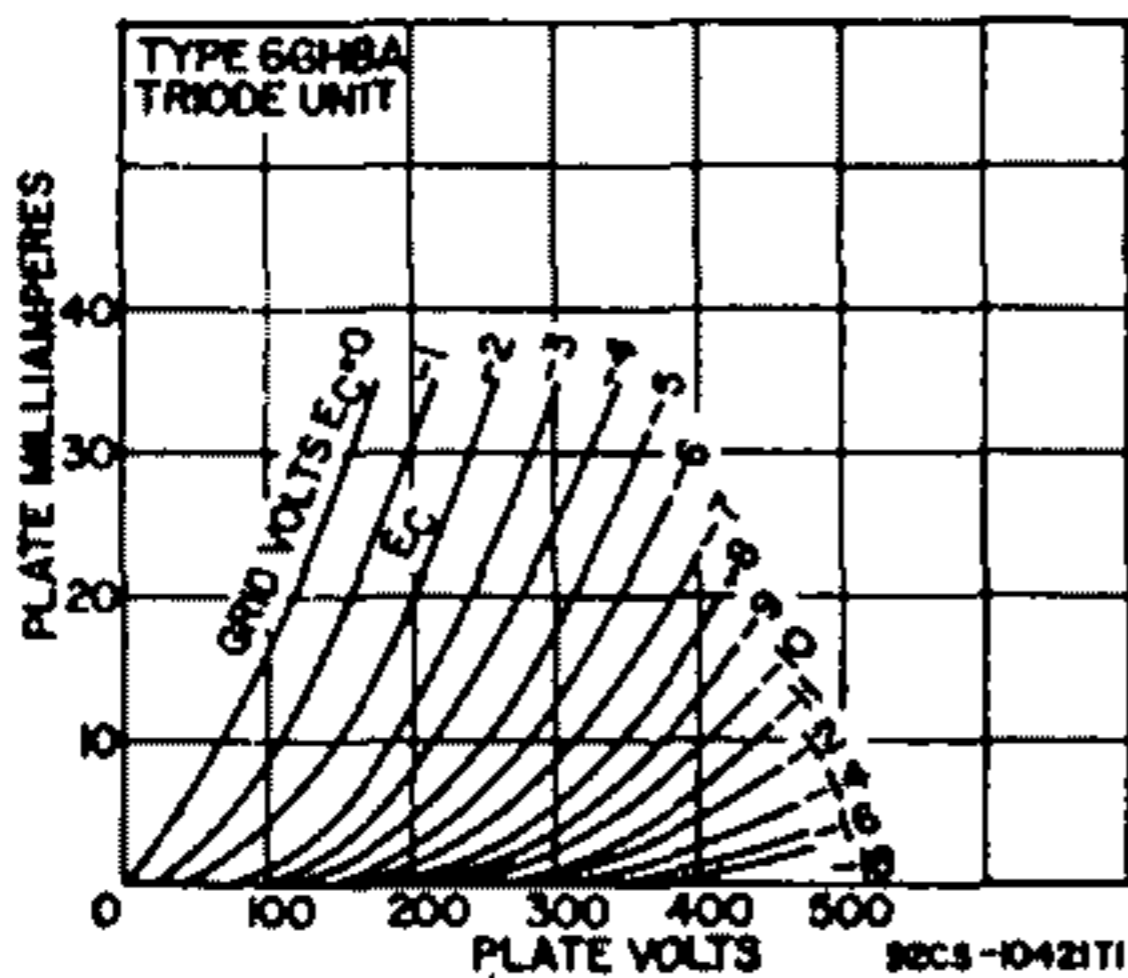
Miniature type used in multivibrator-type horizontal-deflection circuits and for agc-amplifier or sync-separator applications in color and black-and-white television receivers. Outlines section, 6B; requires miniature 9-contact socket. Type 5GH8A is identical with type 6GH8A except for heater ratings.

	5GH8A	6GH8A	
Heater Voltage (ac/dc) . . . . .	4.7	6.3	volts
Heater Current . . . . .	0.6	0.45	ampere
Heater Warm-up Time (Average) . . . . .	11	11	seconds
Heater-Cathode Voltage:			
Peak value . . . . .	±200 max	±200 max	volts
Average value . . . . .	100 max	100 max	volts
Direct Interelectrode Capacitances:			
Triode Unit:			
Grid to Plate . . . . .	1.7	1.7	pF
Grid to Cathode, Heater, Pentode Grid No.3, Pentode Cathode, and Internal Shield . . . . .	3	3.2	pF
Plate to Cathode, Heater, Pentode Grid No.3, Pentode Cathode, and Internal Shield . . . . .	1.4	1.9	pF
Heater to Cathode . . . . .	3	3	pF
Pentode Unit:			
Grid No.1 to Plate . . . . .	0.02 max	0.01 max	pF
Grid No.1 to Cathode, Heater, Grid No.2, Grid No.3, and Internal Shield . . . . .	6	6	pF
Plate to Cathode, Heater, Grid No.2, Grid No.3, and Internal Shield . . . . .	2.6	3.4	pF
Heater to Cathode, Grid No.3, and Internal Shield . . . . .	3	3	pF

**Class A<sub>1</sub> Amplifier**

**CHARACTERISTICS**

	Triode Unit	Pentode Unit	
Plate Voltage . . . . .	125	125	volts
Grid-No.2 Voltage . . . . .	—	125	volts
Grid-No.1 Voltage . . . . .	—1	—1	volts
Amplification Factor . . . . .	46	—	
Plate Resistance (Approx.) . . . . .	5400	200000	ohms
Transconductance . . . . .	8500	7500	μmhos
Plate Current . . . . .	13.5	12	mA
Grid-No.2 Current . . . . .	—	4	mA
Grid-No.1 Voltage (Approx.) for plate current of 10 μA . . . . .	—8	—8	volts





**Horizontal-Deflection Oscillator**

For operation in a 525-line, 30-frame system

MAXIMUM RATINGS (Design-Maximum Values)	Triode Unit	Pentode Unit	
Plate Voltage	330	360	volts
Grid-No.2 (Screen-Grid) Voltage	—	330	volts
Grid-No.1 (Control-Grid) Voltage:			
Positive-bias value	0	0	volts
Peak negative value	—	-175	volts
Peak Cathode Current	—	300	mA
Average Cathode Current	—	20	mA
Plate Dissipation	2.5	2.5	watts
Grid-No.2 Input	—	0.55	watt
<b>MAXIMUM CIRCUIT VALUES</b>			
Grid-No.1-Circuit Resistance:			
For fixed-bias operation	2.2	2.2	megohms
For cathode-bias operation	2.2	2.2	megohms

**6GJ5**

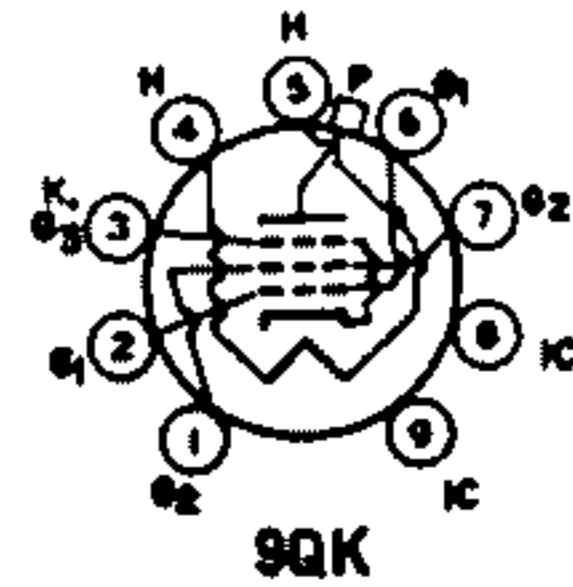
Refer to chart at end of section.

**6GJ5A**

**BEAM POWER TUBE**

12GJ5A, 17GJ5A

Novar type used in high-efficiency horizontal-deflection-amplifier circuits of television receivers. Outlines section, 32; requires novar 9-contact socket. For curve of average characteristics see type 6GW6. Types 12GJ5A and 17GJ5A are identical with type 6GJ5A except for heater ratings.



	6GJ5A	12GJ5A	17GJ5A	
Heater Voltage (ac/dc)	6.3	12.6	16.8	volts
Heater Current	1.2	0.6	0.45	amperes
Heater Warm-up Time (Average)	—	11	11	seconds
Heater-Cathode Voltage:				
Peak value	±200 max	±200 max	±200 max	volts
Average value	100 max	100 max	100 max	volts
Direct Interelectrode Capacitances (Approx.):				
Grid No.1 to Plate	—	—	0.26	pF
Grid No.1 to Cathode, Heater, Grid No.2, and Grid No.3	—	—	15	pF
Plate to Cathode, Heater, Grid No.2, and Grid No.3	—	—	6.5	pF

**Class A<sub>1</sub> Amplifier**

CHARACTERISTICS	Triode Connection		Pentode Connection	
	Plate Voltage	150	60	250
Grid-No.2 Voltage	150	150	150	volts
Grid-No.1 Voltage	-22.5	0	-22.5	volts
Mu-Factor, Grid No.2 to Grid No.1	4.4	—	—	
Plate Resistance (Approx.)	—	—	15000	ohms
Transconductance	—	—	7100	μmhos
Plate Current	—	390*	70	mA
Grid-No.2 Current	—	32*	2.1	mA
Grid-No.1 Voltage for plate current of 1 mA	—	—	-42	volts

\* This value can be measured by a method involving a recurrent waveform such that the maximum ratings of the tube will not be exceeded.

**Horizontal-Deflection Amplifier**

For operation in a 525-line, 30-frame system

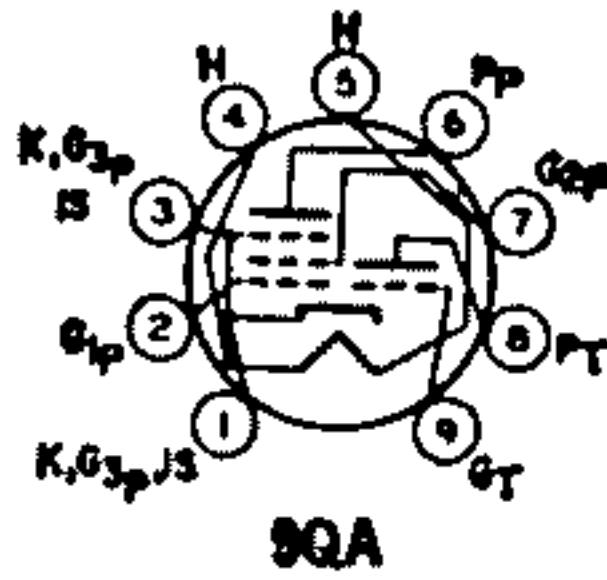
MAXIMUM RATINGS (Design-Maximum Values)		
DC Plate Supply Voltage	770	volts
Peak Positive-Pulse Plate Voltage*	6500	volts
Peak Negative-Pulse Plate Voltage	-1500	volts
DC Grid-No.2 Voltage	220	volts
DC Grid-No.1 Voltage	-55	volts
Peak Negative-Pulse Grid-No.1 Voltage	-330	volts
Peak Cathode Current	550	mA
Average Cathode Current	175	mA
Plate Dissipation*	17.5	watts
Grid-No.2 Input	3.5	watts
Bulb Temperature (at hottest point)	240	°C

**MAXIMUM CIRCUIT VALUE**

Grid-No.1-Circuit Resistance:		
For grid-resistor-bias operation*	1	megohm

\* Pulse duration must not exceed 15% of a horizontal scanning cycle (10 microseconds).

\* A bias resistor or other means is required to protect the tube in absence of excitation.



**MEDIUM-MU TRIODE—  
SHARP-CUTOFF PENTODE**

**6GJ7  
6GJT/  
ECF801  
8GJ7**

Miniature types used as combined oscillator and mixer tubes in color and black-and-white television receivers utilizing an intermediate frequency in the order of 40 MHz. Outlines section, 6J; require miniature 9-contact socket. Type 8GJ7 is identical with types 6GJ7 and 6GJ7/ECF801 except for heater ratings.

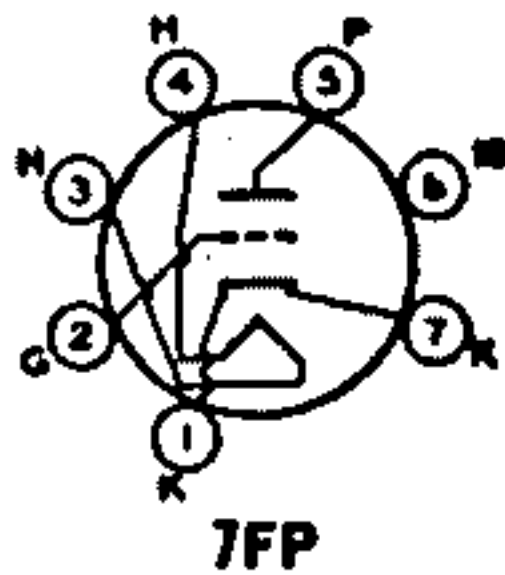
	6GJ7	6GJ7/ECF801	8GJ7	
Heater Voltage (ac/dc)	6.3	6.3	8.0	volts
Heater Current	0.41	0.41	0.3	ampere
Peak Heater-Cathode Voltage <sup>a</sup>	±110 max	±110 max	±110 max	volts

**Class A<sub>1</sub> Amplifier**

MAXIMUM RATINGS (Design-Maximum Values)	Triode Unit Pentode Unit		
	Triode Unit	Pentode Unit	
Plate-Supply Voltage	600	600	volts
DC Plate Voltage	140	275	volts
Grid-No.2 (Screen-Grid) Supply Voltage	—	600	volts
DC Grid-No.2 Voltage	—	275	volts
DC Grid-No.1 (Control-Grid) Voltage	—	-50	volts
Cathode Current	22	20	mA
Plate Dissipation	1.8	2.4	watts
Grid-No.2 Input <sup>c</sup>	—	0.55	watt
<b>CHARACTERISTICS</b>			
DC Plate Voltage	100	170	volts
DC Grid-No.2 Voltage	—	120	volts
DC Grid-No.1 Voltage	-3	-1.2	volts
Amplification Factor	20	55 <sup>b</sup>	
Plate Resistance (Approx.)	—	0.35	megohm
Transconductance	9000	11000	μmhos
Plate Current	15	10	mA
Grid-No.2 Current	—	3	mA
Grid-No.1 Voltage for grid-No.1 current of 0.3 μA	-1.3 max	-1.3 max	volts
Grid-No.1-Circuit Resistance:			
For fixed-bias operation	0.5	1	megohm
For cathode-bias operation	0.5	2.2	megohms

<sup>a</sup> The hum should be minimized in intercarrier applications by limiting the heater-cathode voltage to 100 volts rms, and in AM receivers to 50 volts rms.  
<sup>b</sup> Grid No.2 to grid No.1, approximate value.  
<sup>c</sup> When control-grid bias is between -1.5 and -2 volts, screen-grid dissipation is limited to 0.50 watt. When this bias is greater than -2 volts, maximum screen-grid dissipation is 0.36 watt.

Refer to chart at end of section.



**HIGH-MU TRIODE**

**6GJ8  
6GK5  
2GK5, 3GK5, 4GK5**

Miniature type with frame grid used as grounded-cathode rf-amplifier tube in vhf tuners of color and black-and-white television receivers. Outlines section, 5C; requires miniature 7-contact socket. Types 2GK5, 3GK5, and 4GK5 are identical with type 6GK5 except for heater ratings.

	2GK5	3GK5	4GK5	6GK5	
Heater Voltage (ac/dc)	2.8	2.8	4.0	6.3	volts
Heater Current	0.6	0.45	0.3	0.18	ampere
Heater Warm-up Time (Average)	11	11	11	—	seconds
Peak Heater-Cathode Voltage	±100 max	±100 max	±100 max	±100 max	volts
Direct Interelectrode Capacitances (Approx.): <sup>a</sup>					
Grid to Plate				0.52	pF
Grid to Cathode, Heater, and Internal Shield				5	pF
Plate to Cathode, Heater, and Internal Shield				3.5	pF
Heater to Cathode				2.5 <sup>a</sup>	pF

- \* With external shield connected to cathode, except as noted.
- With external shield and internal shield connected to ground.

**Class A<sub>1</sub> Amplifier**

**MAXIMUM RATINGS (Design-Maximum Values)**

Plate Voltage .....	200	volts
Grid Voltage:		
Negative-bias value .....	-50	volts
Positive-bias value .....	0	volts
Average Cathode Current .....	22	mA
Plate Dissipation .....	2.6	watts

**CHARACTERISTICS**

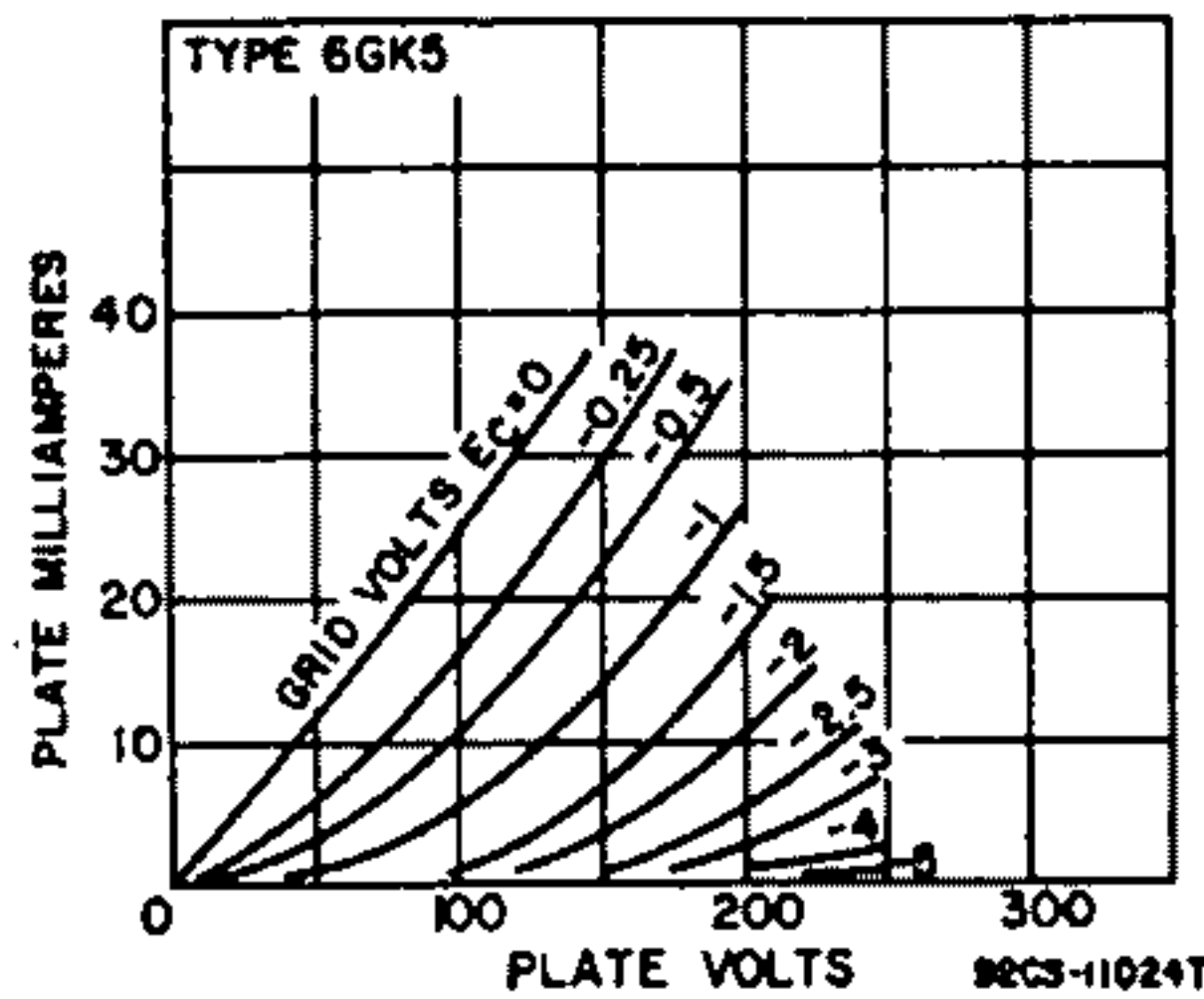
Plate Voltage .....	135	volts
Grid Voltage .....	-1	volts
Amplification Factor .....	78	
Plate Resistance (Approx.) .....	5400	ohms
Transconductance .....	15000	$\mu$ mbos
Plate Current .....	11.5	mA
Input Resistance* .....	275	ohms
Input Capacitance* .....	11.2	pF
Noise Figure† .....	4.7	dB
Grid Voltage (Approx.) for transconductance of 150 $\mu$ mbos .....	-4.2	volts
Grid Voltage (Approx.) for transconductance of 1500 $\mu$ mbos .....	-2.6	volts

**MAXIMUM CIRCUIT VALUE**

Grid-Circuit Resistance, for cathode-bias operation .....	1	megohm
---	---	--------

\* Measured at 200 MHz with heater volts = 6.3 and plate effectively grounded for rf voltages.

† For a neutralized triode amplifier at a frequency of 200 MHz with signal source impedance adjusted for minimum noise output.

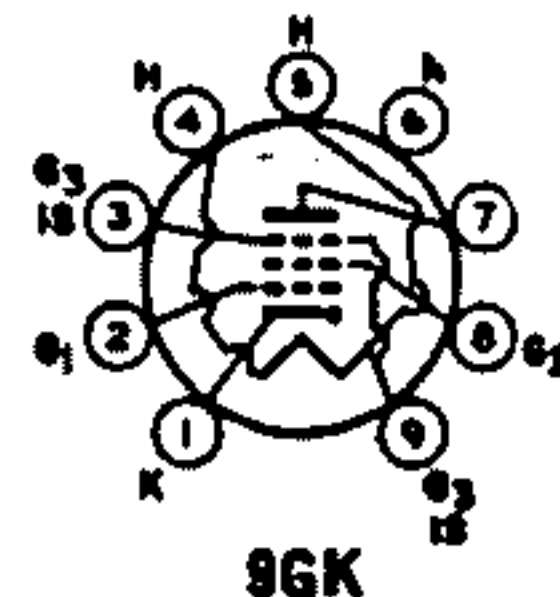


**6GK6**

10GK6, 16GK6

**POWER PENTODE**

Miniature type used in the output stage of audio amplifying equipment and also in the video output stage of color and black-and-white television receivers. Outlines section, 6G; requires miniature 9-contact socket. Types 10GK6 and 16GK6 are identical with type 6GK6 except for heater ratings.



	6GK6	10GK6	16GK6	
Heater Voltage (ac/dc) .....	6.3	10.6	16	volts
Heater Current .....	0.76	0.45	0.3	ampere
Heater Warm-up Time (Average) .....	—	11	11	seconds
Peak Heater-Cathode Voltage .....	±100 max	±100 max	±100 max	volts
Direct Interelectrode Capacitances:				
Grid No.1 to Plate .....			0.14 max	pF
Grid No.1 to Cathode, Heater, Grid No.2, Grid No.3, and Internal Shield .....			10	pF
Plate to Cathode, Heater, Grid No.2, Grid No.3, and Internal Shield .....			7	pF



Class A<sub>1</sub> Amplifier

MAXIMUM RATINGS (Design-Maximum Values)

Plate Supply Voltage	605	volts
Plate Voltage	330	volts
Grid-No.2 Supply Voltage	605	volts
Grid-No.2 (Screen-Grid) Voltage	330	volts
Grid-No.1 (Control-Grid) Voltage, Negative-bias value	-100	volts
Cathode Current	65	mA
Plate Dissipation	13.2	watts
Grid-No.2 Input, Peak	4	watts
Grid-No.2 Input, Average	2	watts

CHARACTERISTICS AND TYPICAL OPERATION

Plate Supply Voltage	250	volts
Grid-No.2 Supply Voltage	250	volts
Cathode-Bias Resistor	135	ohms
Mu-Factor, Grid No.2 to Grid No.1	19	
Plate Resistance (Approx.)	38000	ohms
Transconductance	11300	μmhos
Peak AF Grid-No.1 Voltage	7.3	volts
Zero-Signal Plate Current	48	mA
Maximum-Signal Plate Current	50.6	mA
Zero-Signal Grid-No.2 Current	5.5	mA
Maximum-Signal Grid-No.2 Current	10	mA
Effective Load Resistance	6200	ohms
Total Harmonic Distortion	10	per cent
Maximum-Signal Power Output	5.7	watts

Push-Pull Class AB<sub>1</sub> and Class B Amplifier

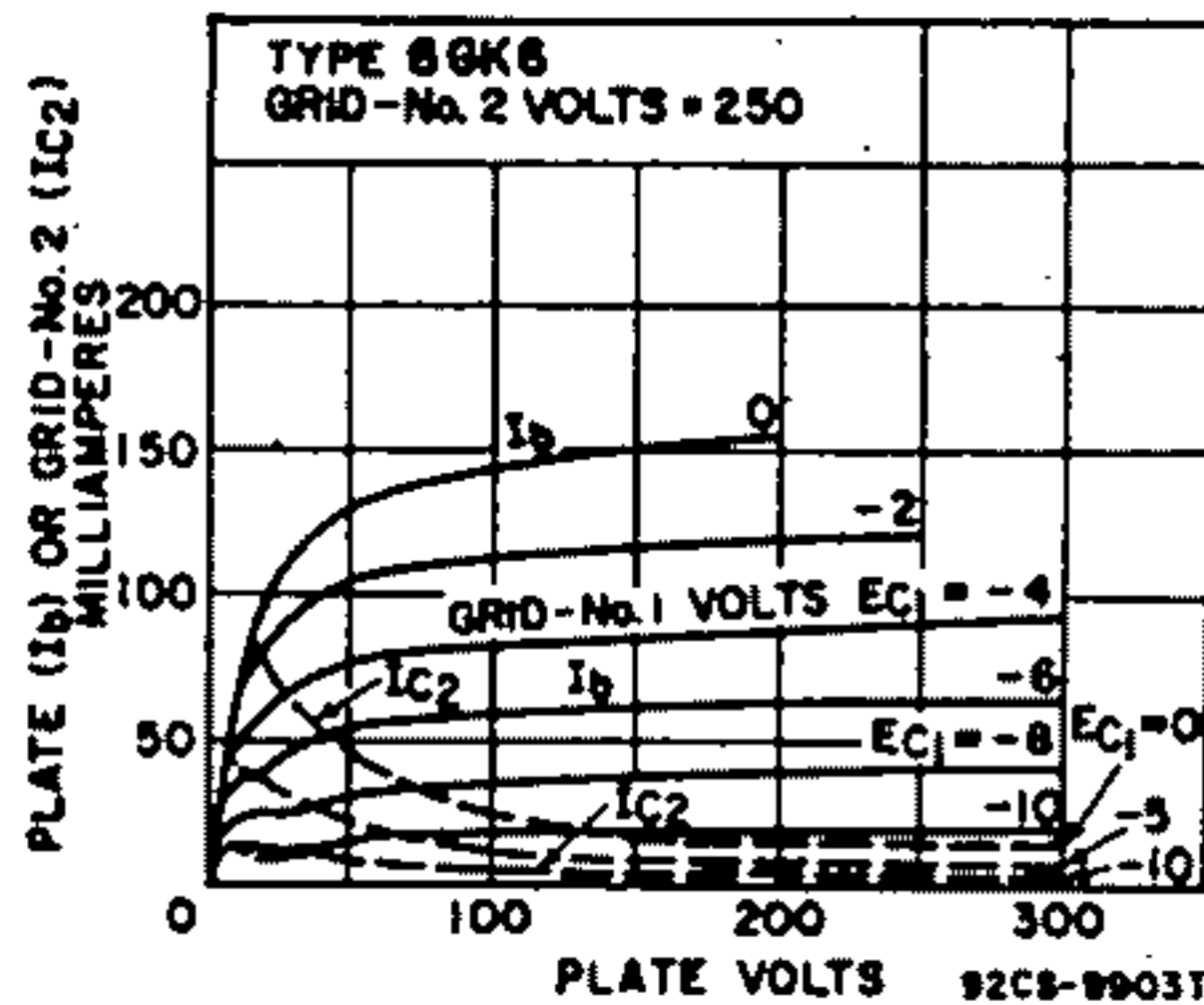
MAXIMUM RATINGS (Same as for Class A<sub>1</sub> Amplifier)

TYPICAL OPERATION (Values are for two tubes)

	Class AB <sub>1</sub>		Class B		
Plate Voltage	250	300	250	300	volts
Grid-No.2 Voltage	250	300	250	300	volts
Grid-No.1 Voltage	—	—	-11.6	-14.7	volts
Cathode-Bias Resistor	130	130	—	—	ohms
Peak AF Grid-No.1-to-Grid-No.1 Voltage	22.4	28	22.4	28	volts
Zero-Signal Plate Current	62	72	20	16	mA
Maximum-Signal Plate Current	75	92	75	92	mA
Zero-Signal Grid-No.2 Current	7	8	2.2	1.6	mA
Maximum-Signal Grid-No.2 Current	16	22	15	22	mA
Effective Load Resistance (plate to plate)	8000	8000	8000	8000	ohms
Total Harmonic Distortion	3	4	3	4	per cent
Maximum-Signal Power Output	11	17	11	17	watts

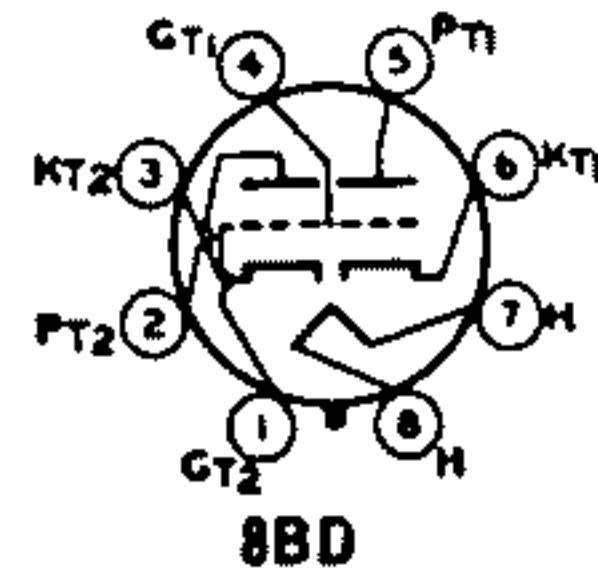
MAXIMUM CIRCUIT VALUES

Grid-No.1-Circuit Resistance:		
For fixed-bias operation	0.3	megohm
For cathode-bias operation	1	megohm



**6GL7****DUAL TRIODE**

Glass type used as combined vertical-deflection-oscillator and vertical-deflection-amplifier tube in color and black-and-white television receivers. Outlines section, 13B; requires octal socket. Heater: volts (ac/dc), 6.3; amperes, 1.05; maximum heater-cathode volts,  $\pm 200$  peak, 100 average.

**Class A<sub>1</sub> Amplifier**

CHARACTERISTICS	Unit No.1	Unit No.2	
Plate Voltage	250	175	volts
Grid Voltage	-3	-25	volts
Amplification Factor	66	5	
Plate Resistance (Approx.)	30000	780	ohms
Transconductance	2200	6400	$\mu$ mhos
Plate Current	2	46	mA
Grid Voltage (Approx.):			
For plate current of 20 $\mu$ A	-5.3	—	volts
For plate current of 200 $\mu$ A	—	-60	volts

**Vertical-Deflection Oscillator and Amplifier**

For operation in a 525-line, 30-frame system

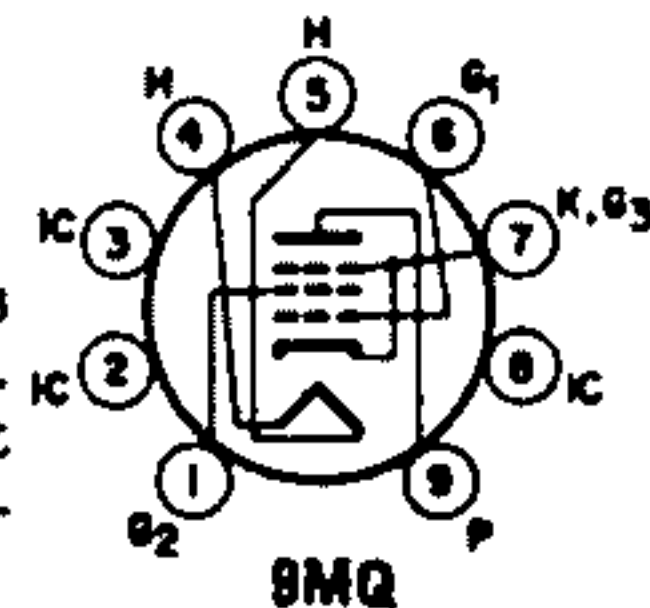
MAXIMUM RATINGS (Design-Maximum Values)	Unit No.1 Oscillator	Unit No.2 Amplifier	
DC Plate Voltage	850	550	volts
Peak Positive-Pulse Plate Voltage	—	1500 <sup>#</sup>	volts
Peak Negative-Pulse Grid Voltage	-400	-250	volts
Peak Cathode Current	—	175	mA
Average Cathode Current	—	50	mA
Plate Dissipation*	1	10	watts
MAXIMUM CIRCUIT VALUES			
Grid-Circuit Resistance:			
For fixed-bias operation	1	1	megohms
For cathode-bias operation	2.2	2.2	megohms

<sup>#</sup> Pulse duration must not exceed 15% of a vertical scanning cycle (2.5 milliseconds).

\* A bias resistor or other means is required to protect the tube in absence of excitation.

**6GM5****POWER PENTODE**

Neonovial type used in television receivers and as power amplifier in radio receivers and audio amplifiers. Outlines section, 10D; requires neonovial 9-contact socket. Heater: volts (ac/dc), 6.3; amperes, 0.8; maximum heater-cathode volts,  $\pm 200$  peak, 100 average.

**Class A<sub>1</sub> Amplifier**

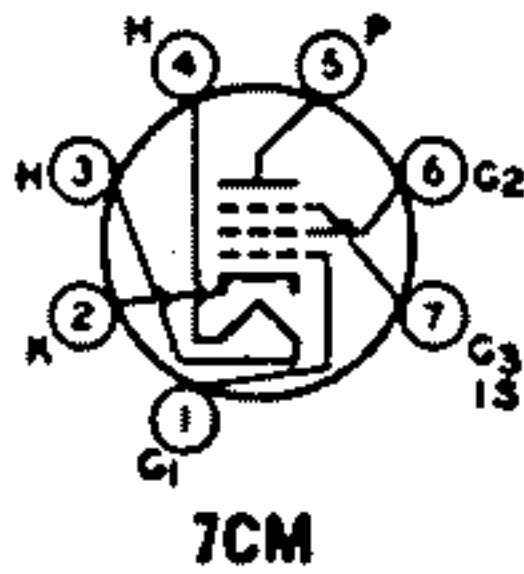
MAXIMUM RATINGS (Design-Maximum Values)		
Plate Voltage	550	volts
Grid-No.2 (Screen-Grid) Voltage	440	volts
Cathode Current	85	mA
Plate Dissipation	19	watts
Grid-No.2 Input	3.3 <sup>*</sup>	watts
TYPICAL OPERATION AND CHARACTERISTICS		
Plate Voltage	300	volts
Grid-No.2 Voltage	300	volts
Grid-No.1 (Control-Grid) Voltage	-10	volts
Peak AF Grid-No.1 Voltage	10	volts
Zero-Signal Plate Current	60	mA
Maximum-Signal Plate Current	75	mA
Zero-Signal Grid-No.2 Current	8	mA
Maximum-Signal Grid-No.2 Current	15	mA
Plate Resistance (Approx.)	29000	ohms
Transconductance	10200	$\mu$ mhos
Load Resistance	3000	ohms
Total Harmonic Distortion	13	per cent
Maximum-Signal Power Output	11	watts

\* Grid-No.2 input may reach 6 watts during peak levels of speech and music signals.

**SEMIREMOTE-CUTOFF  
PENTODE**

**6GM6**

4GM6, 5GM6



Miniature type used in gain-controlled picture-if stages of color and black-and-white television receivers operating at intermediate frequencies in the order of 40 MHz. Outlines section, 5C; requires 7-contact socket. Types 4GM6 and 5GM6 are identical with type 6GM6 except for heater ratings.

	4GM6	5GM6	6GM6	
Heater Voltage (ac/dc)	4.2	5.6	6.6	volts
Heater Current	0.6	0.45	0.4	ampere
Heater Warm-up Time (Average)	11	11	—	seconds
Heater-Cathode Voltage:				
Peak value	±200 max	±200 max	±200 max	volts
Average value	190 max	100 max	100 max	volts
Direct Interelectrode Capacitances:				
Grid No.1 to Plate		Unshielded 0.036 max	Shielded* 0.026 max	pF
Grid No.1 to Cathode, Heater, Grid No.2, Grid No.3, and Internal Shield		10	10	pF
Plate to Cathode, Heater, Grid No.2, Grid No.3, and Internal Shield		2.4	3.4	pF

\* With external shield connected to cathode.

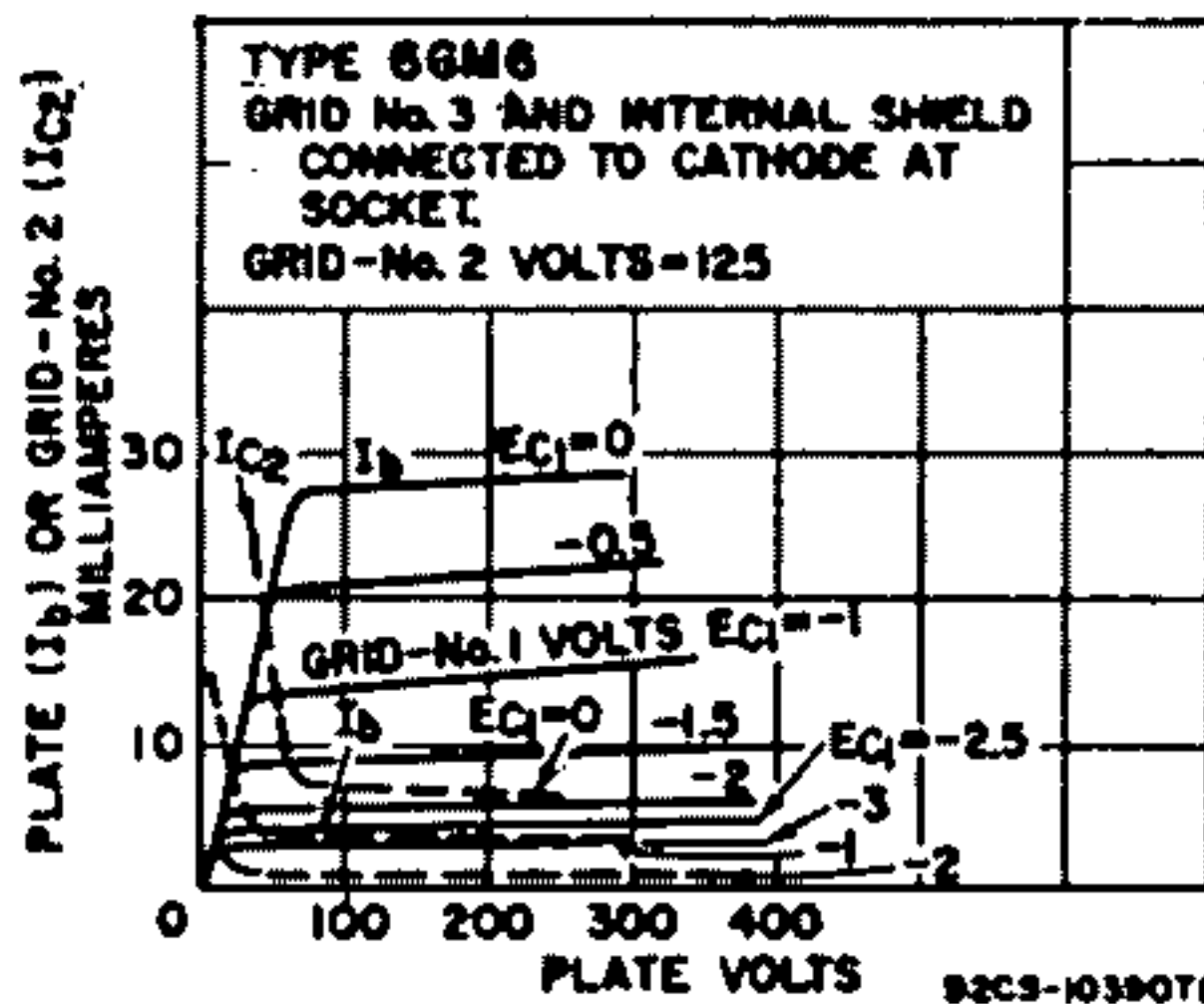
**Class A<sub>1</sub> Amplifier**

**MAXIMUM RATINGS (Design-Maximum Values)**

Plate Voltage	330	volts
Grid-No.3 (Suppressor-Grid) Voltage, Positive value	0	volts
Grid-No.2 (Screen-Grid) Supply Voltage	330	volts
Grid-No.2 Voltage	See curve page 96	
Grid-No.1 (Control-Grid) Voltage, Positive-bias value	0	volts
Plate Dissipation	3.1	watts
Grid-No.2 Input:		
For grid-No.2 voltages up to 165 volts	0.65	watt
For grid-No.2 voltages between 165 and 330 volts	See curve page 96	

**CHARACTERISTICS**

Plate Supply Voltage	125	volts
Grid No.3	Connected to cathode at socket	
Grid-No.2 Supply Voltage	125	volts
Cathode-Bias Resistor	66	ohms
Plate Resistance (Approx.)	0.2	megohm
Transconductance	13000	μmhos
Plate Current	14	mA
Grid-No.2 Current	3.4	mA
Grid-No.1 Voltage (Approx.) for transconductance of 60 μmhos	-15	volts



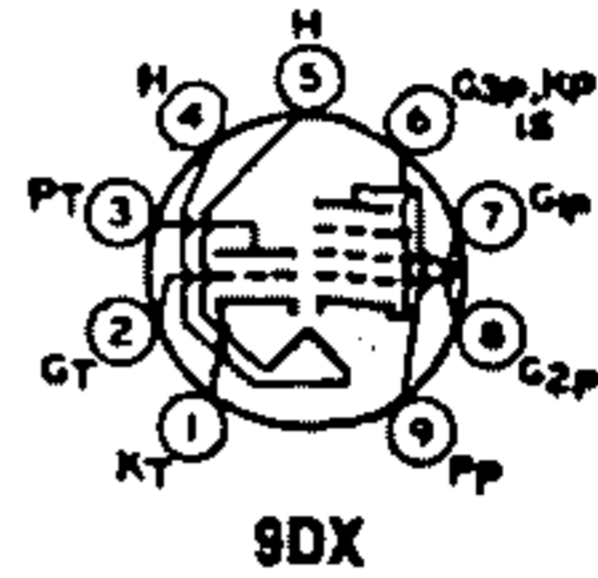


# 6GN8

8GN8, 10GN8

## HIGH-MU TRIODE— SHARP-CUTOFF PENTODE

Miniature type used in color and black-and-white television receiver applications. Triode unit is used as sync-separator, sync-clipper, phase inverter, or sound-if amplifier. Pentode unit is used in output stage of video amplifier. Outlines section, 6E; requires miniature 9-contact socket. For direct interelectrode capacitances, refer to type 6EB8; curve for average plate characteristics of triode unit is same as for type 6EB8. Types 8GN8 and 10GN8 are identical with type 6GN8 except for heater ratings.



	6GN8	8GN8	10GN8	
Heater Voltage (ac/dc)	6.3	8	10.5	volts
Heater Current	0.75	0.6	0.45	ampere
Heater Warm-up Time (Average)	—	11	11	seconds
Heater-Cathode Voltage:				
Peak value	±200 max	±200 max	±200 max	volts
Average value	100 max	100 max	100 max	volts

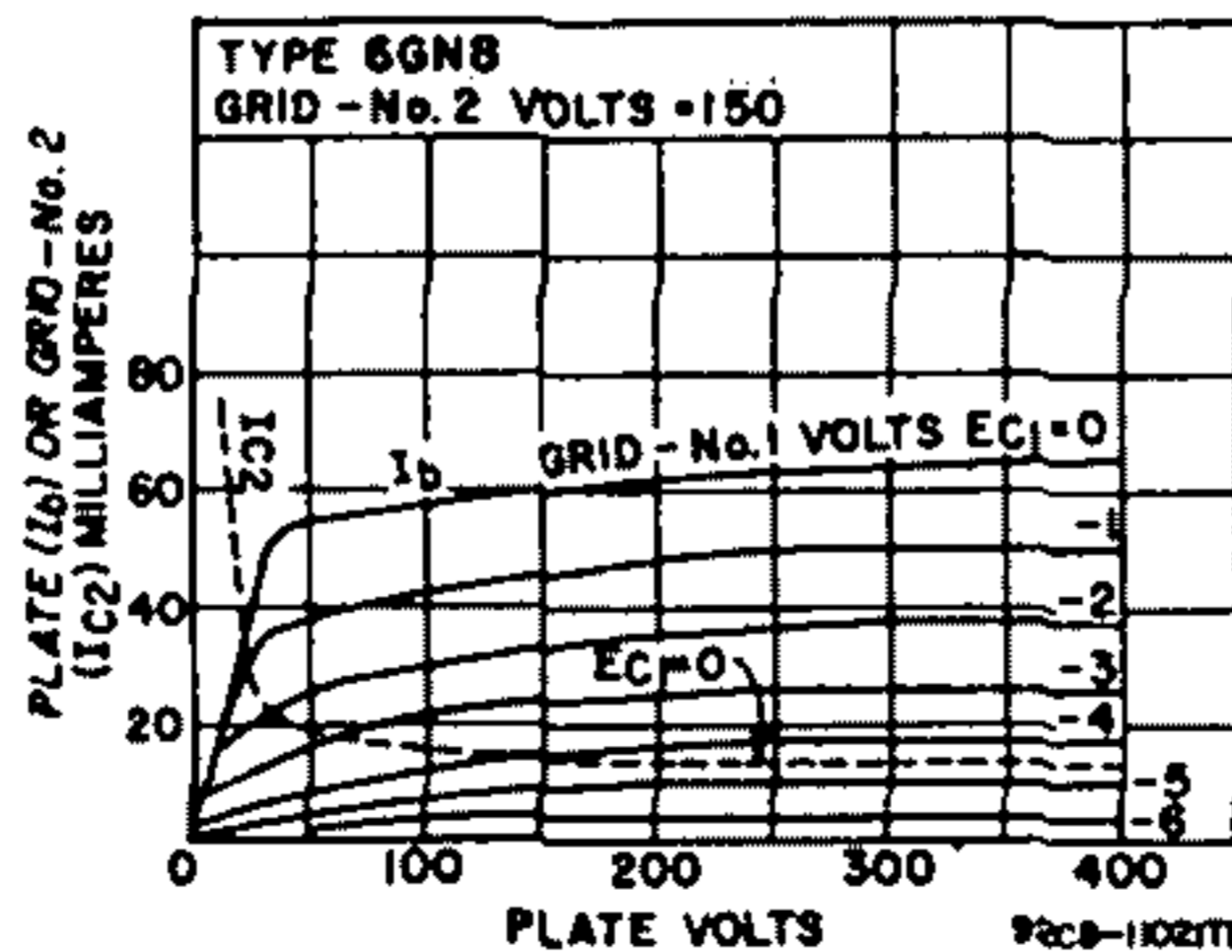
### Class A<sub>1</sub> Amplifier

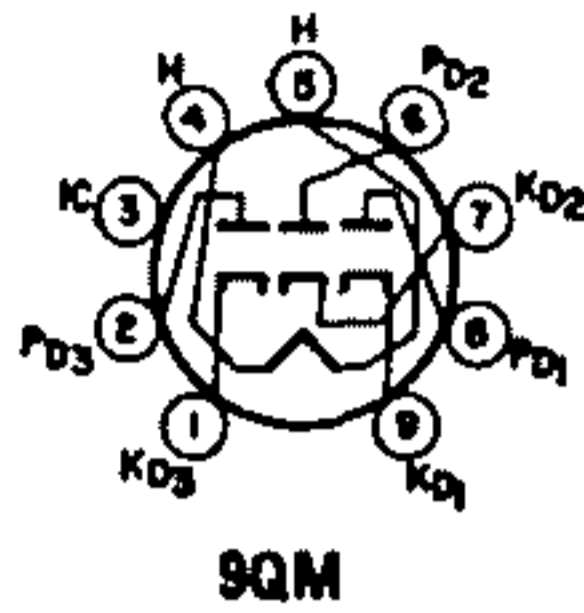
MAXIMUM RATINGS (Design-Maximum Values)	Triode Unit	Pentode Unit	
Plate Voltage	330	330	volts
Grid-No.2 (Screen-Grid) Supply Voltage	—	330	volts
Grid-No.2 Voltage	—	See curve page 96	
Grid-No.1 (Control-Grid) Voltage, Positive-bias value	0	0	volt
Plate Dissipation	1	5	watts
Grid-No.2 Input:			
For grid-No.2 voltages up to 165 volts	—	1.1	watts
For grid-No.2 voltages between 165 and 330 volts	—	See curve page 96	

CHARACTERISTICS	Triode Unit	Pentode Unit	
Plate Supply Voltage	250	60 200	volts
Grid-No.2 Supply Voltage	—	150 150	volts
Grid-No.1 Voltage	—2	0 —	volts
Cathode-Bias Resistor	—	— 100	ohms
Amplification Factor	100	— —	
Plate Resistance (Approx.)	37000	— 60000	ohms
Transconductance	2700	— 11500	μmhos
Plate Current	2	55* 25	mA
Grid-No.2 Current	—	18* 5.5	mA
Grid Voltage (Approx.) for plate current of 20 μA	—5	— —	volts
Grid-No.1 Voltage (Approx.) for plate current of 100 μA	—	— -10	volts

MAXIMUM CIRCUIT VALUES	Triode Unit	Pentode Unit	
Grid-No.1-Circuit Resistance:			
For fixed-bias operation	0.5	0.25	megohm
For cathode-bias operation	1	1	megohm

\* This value can be measured by a method involving a recurrent waveform such that the maximum ratings of the tube will not be exceeded.



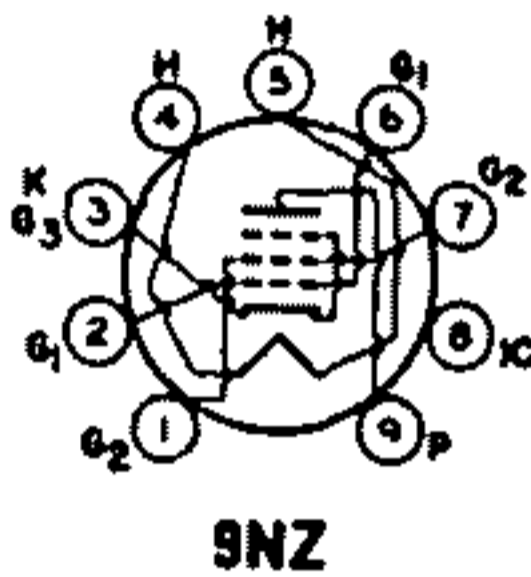


**TRIPLE DIODE**

**6GQ7**  
19GQ7

Miniature type used in AM/FM radio receivers as a combination FM discriminator and AM detector tube. Outlines section, 6B; requires miniature 9-contact socket. Type 19GQ7 is identical with type 6GQ7 except for heater ratings.

Heater Voltage (ac/dc) .....	6GQ7 6.3	19GQ7 18.9	volts
Heater Current .....	0.45	0.15	ampere
Heater-Cathode Voltage:			
Peak value .....	+200, -300 max		volts
Average value .....	100 max		volts
<b>MAXIMUM RATINGS (Design-Maximum Values)</b>			
Peak Inverse Voltage .....		330	volts
AC Plate Voltage .....		117	volts
AC Plate Current .....		54	mA
DC Output Current .....		9	mA
Minimum Total Effective Plate Supply Impedance .....		300	ohms
<b>CHARACTERISTICS (Each Diode Unit)</b>			
Tube Voltage Drop for plate current of 60 mA .....		10	volts



**BEAM POWER TUBE**

**6GT5**  
**6GT5A**  
12GT5  
17GT5, 17GT5A

Novar types used as horizontal-deflection amplifiers in television receivers. Outlines section, 17B and 31A, respectively; require novar 9-contact socket. For curve of average characteristics, refer to type 6GW6. Type 12GT5 and types 17GT5 and 17GT5A are identical with types 6GT5 and 6GT5A except for heater ratings.

	<b>6GT5</b> <b>6GT5A</b>	<b>12GT5</b>	<b>17GT5</b> <b>17GT5A</b>	
Heater Voltage (ac/dc) .....	6.3	12.6	16.8	volts
Heater Current .....	1.2	0.6	0.45	amperes
Heater Warm-up Time (Average) .....	—	11	11	seconds
Heater-Cathode Voltage:				
Peak value .....	±200 max	±200 max	±200 max	volts
Average value .....	100 max	100 max	100 max	volts
<b>Direct Interelectrode Capacitances (Approx.):</b>				
Grid No.1 to Plate .....			0.26	pF
Grid No.1 to Cathode, Heater, Grid No.2, and Grid No.3 .....			15	pF
Plate to Cathode, Heater, Grid No.2, and Grid No.3 .....			8.5	pF

**Class A<sub>1</sub> Amplifier**

<b>CHARACTERISTICS</b>	<b>Triode</b> <b>Connection</b>	<b>Pentode</b> <b>Connection</b>	
Plate Voltage .....	150	60 250	volts
Grid-No.2 (Screen-Grid) Voltage .....	150	150 150	volts
Grid-No.1 (Control-Grid) Voltage .....	-22.5	0 -22.5	volts
Mu Factor, Grid No.2 to Grid No.1 .....	4.4	— —	
Plate Resistance (Approx.) .....	—	— 15000	ohms
Transconductance .....	—	— 7100	μmhos
Plate Current .....	—	390* 70	mA
Grid-No.2 Current .....	—	82* 2.1	mA
Grid-No.1 Voltage (Approx.) for plate current of 1 mA .....	—	— -42	volts

\* These values can be measured by a method involving a recurrent waveform such that the plate dissipation and grid-No.2 input will not exceed their maximum ratings.

**Horizontal-Deflection Amplifier**

For operation in a 525-line, 30-frame system

<b>MAXIMUM RATINGS (Design-Maximum Values)</b>			
DC Plate Supply Voltage .....		770	volts
Peak Positive-Pulse Plate Voltage* .....		6500	volts

Peak Negative-Pulse Plate Voltage .....	-1500	volts
DC Grid-No.2 Voltage .....	220	volts
DC Grid-No.1 Voltage .....	-55	volts
Peak Negative-Pulse Grid-No.1 Voltage .....	-330	volts
Peak Cathode Current .....	550	mA
Average Cathode Current .....	175	mA
Plate Dissipation* .....	17.5	watts
Grid-No.2 Input .....	3.5	watts
Bulb Temperature (At hottest point) .....	240	°C

**MAXIMUM CIRCUIT VALUE**

Grid-No.1-Circuit Resistance, For grid-resistor-bias operation\* .... 1 megohm

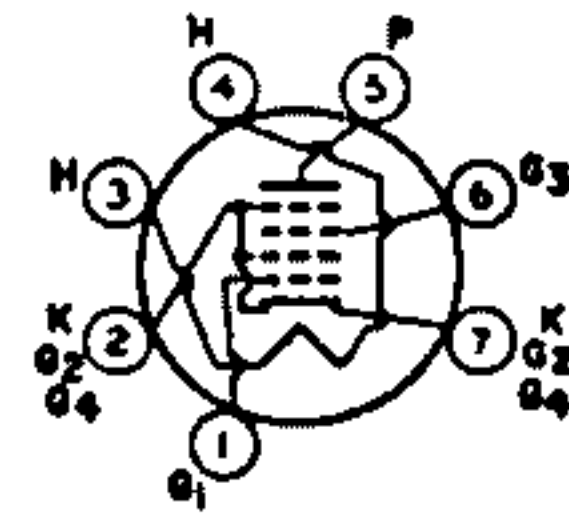
\* Pulse duration must not exceed 15% of a horizontal scanning cycle (10 microseconds).

\* A bias resistor or other means is required to protect the tube in absence of excitation.

**6GU5**  
2GU5

**BEAM HEXODE**

Miniature type used as rf amplifier in vhf television receivers. Outlines section, 5C; requires miniature 7-contact socket. Type 2GU5 is identical with type 6GU5 except for heater ratings.



7GA

Heater Voltage (ac/dc) .....	2GU5	6GU5	
Heater Current .....	2.4	6.3	volts
Heater Warm-up Time (Average) .....	0.6	0.22	ampere
Heater-Cathode Voltage:	11	—	seconds
Peak value .....	±200 max	±200 max	volts
Average value .....	100 max	100 max	volts
Direct Interelectrode Capacitances:			
Grid No.1 to Plate .....		0.018	pF
Grid No.1 to Cathode, Heater, Grid No.2, Grid No.3, and Grid No.4 .....		7	pF
Plate to Cathode, Heater, Grid No.2, Grid No.3, and Grid No.4 .....		3.2	pF

**Class A<sub>1</sub> Amplifier**

**MAXIMUM RATINGS (Design-Maximum Values)**

Plate Voltage .....		300	volts
Grid-No.3 (Screen-Grid) Voltage:		150	volts
DC Grid-No.1 (Control-Grid) Voltage:			
Positive-bias value .....		0	volts
Negative-bias value .....		-50	volts
Average Cathode Current .....		20	mA
Plate Dissipation .....		3	watts
Grid-No.3 Input .....		0.15	watts

**CHARACTERISTICS**

Plate Voltage .....	135	275	volts
Grid-No.3 Voltage .....	135	185	volts
Grid-No.1 Voltage .....	-0.4	-0.4	volts
Plate Resistance (Approx.) .....	0.67	0.165	megohms
Transconductance .....	15000	15500	μmbos
Plate Current .....	9	10	mA
Grid-No.3 Current .....	0.25	0.17	mA
Grid-No.1 Voltage (Approx.) for transconductance of 100 μmbos .....	-6.2	-6.5	volts

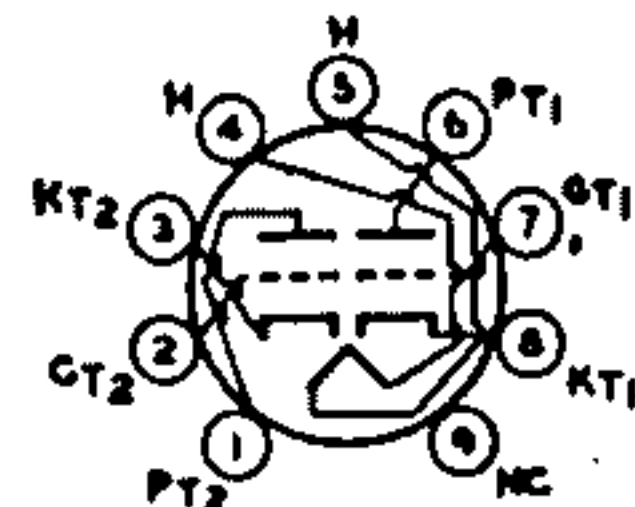
**MAXIMUM CIRCUIT VALUE**

Grid-No.1-Circuit Resistance, for fixed-bias operation ..... 0.5 megohm

**6GU7**

**MEDIUM-MU TWIN TRIODE**

Miniature type used in the matrixing circuits of color and black-and-white television receivers and in phase-inverter, multivibrator, and general-purpose amplifier applications. Outlines section, 6E; requires miniature 9-contact socket.



9LP



Heater Voltage (ac/dc)	6.3	volts
Heater Current	0.6	ampere
Heater Warm-up Time (Average)	11	seconds
Heater-Cathode Voltage:		
Peak value	±200 max	volts
Average value	100 max	volts
Direct Interelectrode Capacitances (Approx.):	Unit No.1	Unit No.2
Grid to Plate	8	3
Grid to Cathode and Heater	3.4	8.6
Plate to Cathode and Heater	0.44	0.34
Plate of Unit No.1 to Plate of Unit No.2		1

**Class A<sub>1</sub> Amplifier**

**MAXIMUM RATINGS (Design-Maximum Values)**

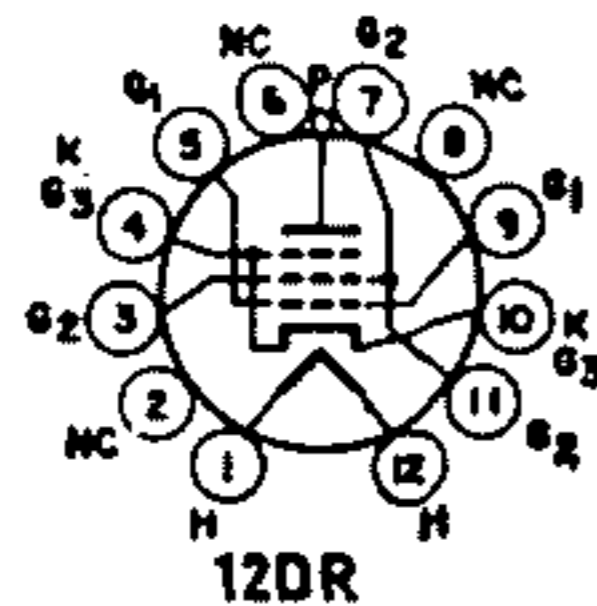
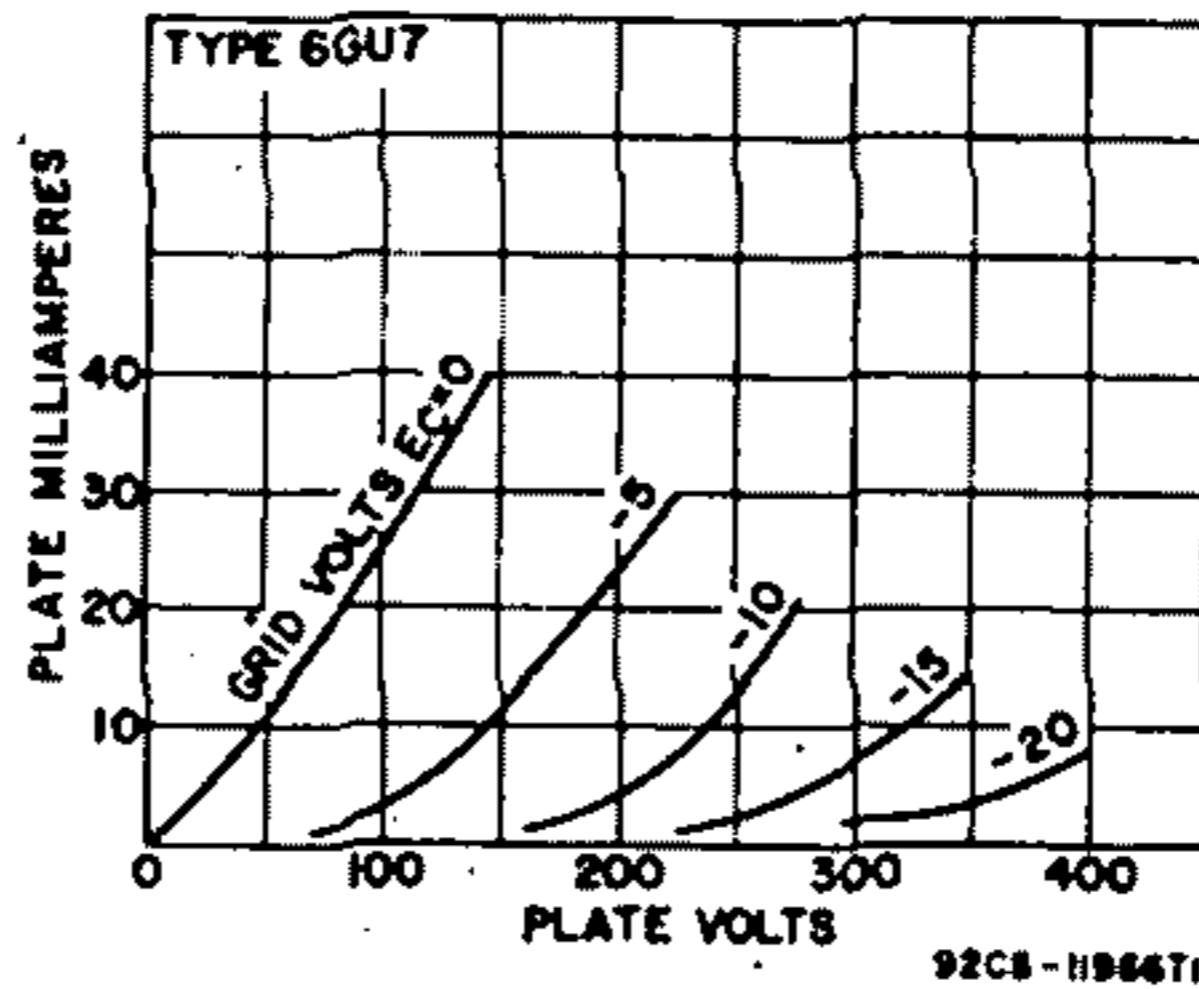
Plate Voltage	330	volts
Grid Voltage, Positive-bias value	0	volts
Plate Dissipation	3	watts

**CHARACTERISTICS**

Plate Voltage	250	volts
Grid Voltage	-10.5	volts
Amplification Factor	17	
Plate Resistance, (Approx.)	5500	ohms
Transconductance	8100	μmhos
Plate Current	11.5	mA
Grid Voltage (Approx.) for plate current of 50 μA	-23	volts
Plate Current for grid voltage of -14 volts	4	mA

**MAXIMUM CIRCUIT VALUE**

Grid-Circuit Resistance, for fixed-bias operation	1	megohm
---	---	--------



**BEAM POWER TUBE**

**6GV5**  
17GV5

Duodecar type used as horizontal-deflection amplifier in television receivers. Outlines section, 16A; requires duodecar 12-contact socket. Type 17GV5 is identical with type 6GV5 except for heater ratings.

	<b>6GV5</b>	<b>17GV5</b>	
Heater Voltage (ac/dc)	6.3	16.8	volts
Heater Current	1.2	0.45	amperes
Heater Warm-up Time (Average)	—	11	seconds
Heater-Cathode Voltage:			
Peak value	±200 max	±200 max	volts
Average value	100 max	100 max	volts

**Class A<sub>1</sub> Amplifier**

**CHARACTERISTICS**

	<b>Pentode Connection</b>		<b>Triode* Connection</b>		
Plate Voltage	5000	60	250	150	volts
Grid-No.2 (Screen-Grid) Voltage	150	150	150	150	volts
Grid-No.1 (Control-Grid) Voltage	—	0	-22.5	-22.5	volts

Plate Resistance (Approx.)	—	—	18000	—	ohms
Transconductance	—	—	7300	—	μmhos
Amplification Factor	—	—	—	4.4	—
Plate Current	—	345*	65	—	mA
Grid-No.2 Current	—	27*	1.8	—	mA
Grid-No.1 Voltage (Approx.) for plate current of 1 mA	-100	—	-42	—	volts

\* Grid No.2 tied to plate.

\* This value can be measured by a method involving a recurrent waveform such that the maximum ratings of the tube will not be exceeded.

### Horizontal-Deflection Amplifier

For operation in a 525-line, 30-frame system

#### MAXIMUM RATINGS (Design-Maximum Values)

DC Plate Supply Voltage	770	volts
Peak Positive-Pulse Plate Voltage*	6500	volts
Peak Negative-Pulse Plate Voltage	-1500	volts
DC Grid-No.2 Voltage	220	volts
Peak Negative-Pulse Grid-No.1 Voltage	-330	volts
DC Grid-No.1 Voltage	-55	volts
Peak Cathode Current	550	mA
Average Cathode Current	175	mA
Plate Dissipation†	17.5	watts
Grid-No.2 Input	3.5	watts
Bulb Temperature (At hottest point)	220	°C

#### MAXIMUM CIRCUIT VALUE

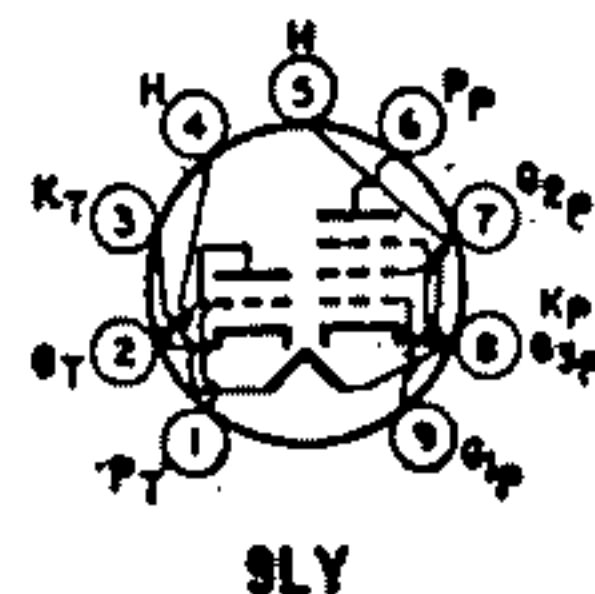
Grid-No.1-Circuit Resistance	1	megohm
------------------------------	---	--------

# Pulse duration must not exceed 15% of a horizontal scanning cycle (10 microseconds).  
 † A bias resistor or other means is required to protect the tube in absence of excitation.

## 6GV8 9GV8

## HIGH-MU TRIODE— POWER PENTODE

Miniature type used for sync-amplifier and video-output applications in television receivers. Outlines section, 6G; requires miniature 9-contact socket. Type 9GV8 is identical with type 6GV8 except for heater ratings.



Heater Voltage (ac/dc)	6GV8 6.3	9GV8 9.5	volts
Heater Current	0.9	0.6	ampere
Peak Heater-Cathode Voltage	±220 max	±220 max	volts

### Class A<sub>1</sub> Amplifier

MAXIMUM RATINGS (Absolute-Maximum Values)	Triode Unit	Pentode Unit	
Plate Supply Voltage	550	550	volts
Peak Plate Voltage*	—	2000	volts
DC Plate Voltage	250	250	volts
Grid-No.2 (Screen-Grid) Supply Voltage	—	550	volts
Grid-No.2 Voltage	—	250	volts
Peak Cathode Current*	200	—	mA
Average Cathode Current	15	75	mA
Plate Dissipation	0.6	7	watts
Grid-No.2 Input	—	2	watts

#### CHARACTERISTICS

Plate Voltage	100	50	65	170	volts
Grid-No.2 Voltage	—	170	210	170	volts
Grid-No.1 Voltage	-0.8	-1	-1	-15	volts
Amplification Factor	50	—	—	—	—
Mu-Factor, Grid No.1 to Grid No.2	—	—	—	7	—
Plate Resistance (Approx.)	7600	—	—	25000	ohms
Transconductance	6500	—	—	7500	μmhos
Plate Current	5	200*	240*	41	mA
Grid-No.2 Current	—	40*	50*	2.7	mA

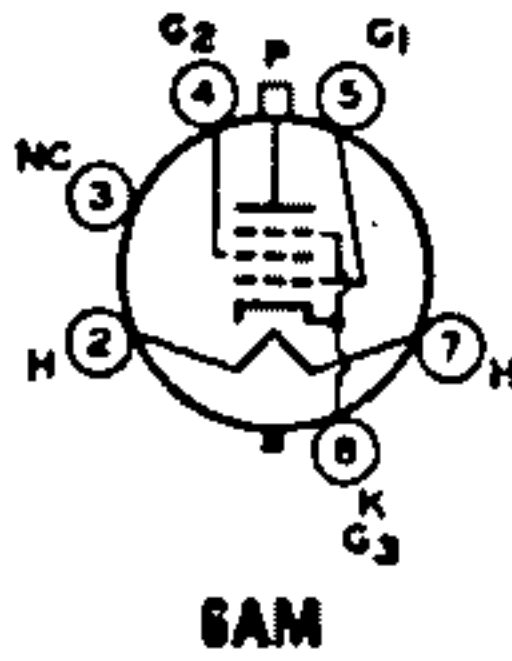
#### MAXIMUM CIRCUIT VALUES

Grid-No.1-Circuit Resistance:			
For fixed-bias operation	1	1	megohm
For cathode-bias operation	3.3	2.2	megohms

\* Maximum pulse duration 5 per cent of a cycle with a maximum of 1 millisecond.  
 \* Maximum pulse duration 200 microseconds. If a larger flyback is required, this value may be reduced to 100 mA with a maximum pulse duration of 400 microseconds.  
 \* This value can be measured by a method involving a recurrent waveform such that the maximum tube ratings will not be exceeded.

Refer to chart at end of section.

6GW6



BEAM POWER TUBE

6GW6/  
6DQ6B

12GW6/12DQ6B  
17GW6/17DQ6B

Glass octal type used as horizontal-deflection amplifier in high-efficiency deflection circuits of television receivers. Outlines section, 20; requires octal socket. Types 12GW6/12DQ6B and 17GW6/17DQ6B are identical with type 6GW6/6DQ6B except for heater ratings.

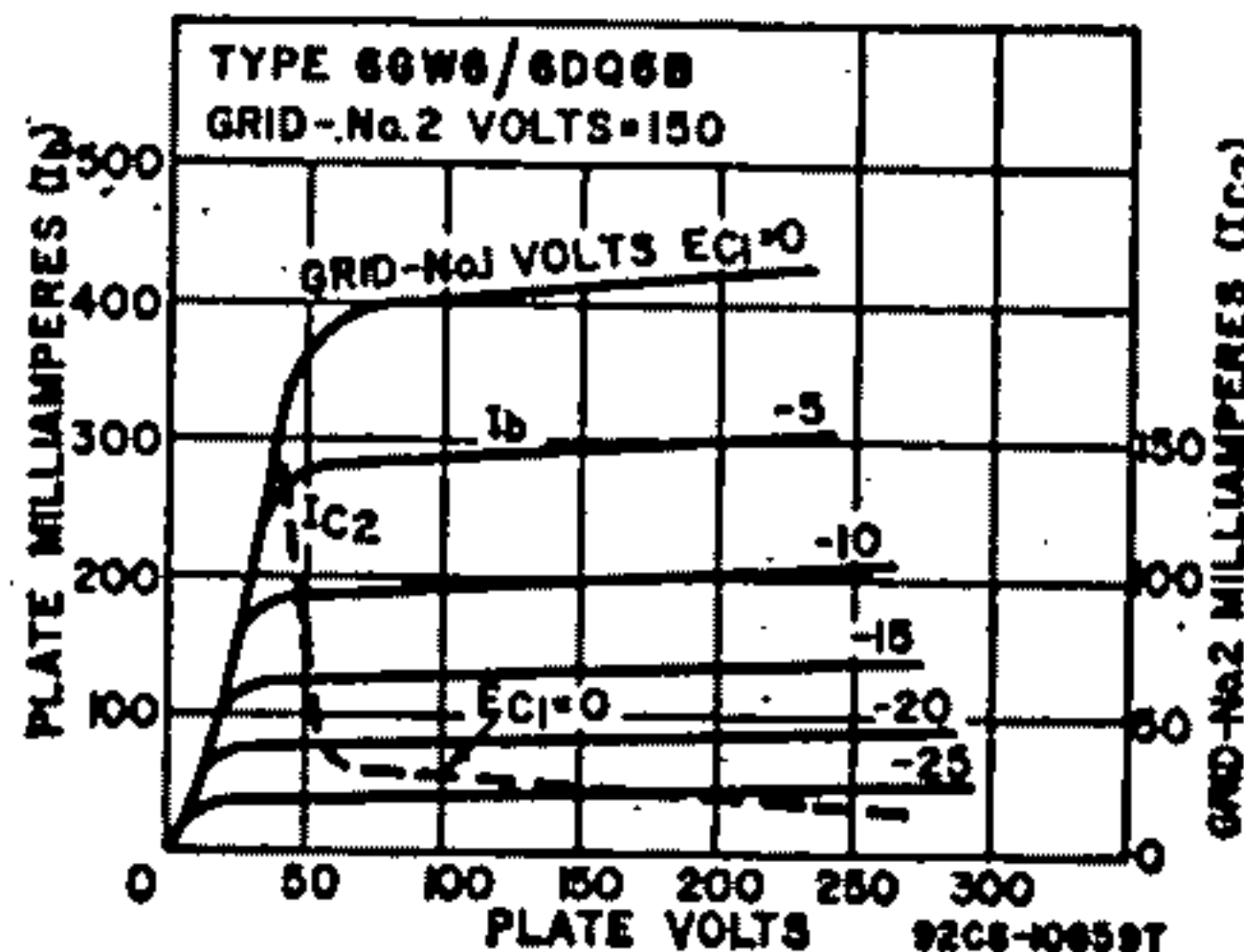
	6GW6/ 6DQ6B	12GW6/ 12DQ6B	17GW6/ 17DQ6B	
Heater Voltage ac/dc)	6.3	12.6	16.8	volts
Heater Current	1.2	0.6	0.45	amperes
Heater Warm-up Time Average)	—	11	11	seconds
Heater-Cathode Voltage:				
Peak value	±200 max	±200 max	±200 max	volts
Average value	100 max	100 max	100 max	volts
Direct Interelectrode Capacitances (Approx.):				
Grid No.1 to Plate	—	—	0.5	pF
Grid No.1 to Cathode, Heater, Grid No.2, and Grid No.3	—	—	17	pF
Plate to Cathode, Heater, Grid No.2, and Grid No.3	—	—	7	pF

Class A<sub>1</sub> Amplifier

CHARACTERISTICS

	Triode Connection	Pentode Connection	
Plate Voltage	150	60 250	volts
Grid-No.2 Voltage	150	150 150	volts
Grid-No.1 Voltage	-22.5	0 -22.5	volts
Mu-factor, Grid No.2 to Grid No.1	4.4	—	—
Plate Resistance (Approx.)	—	— 15000	ohms
Transconductance	—	— 7100	μmhos
Plate Current	—	390* 70	mA
Grid-No.2 Current	—	82* 2.1	mA
Grid-No.1 Voltage (Approx.) for plate current of 1 mA	—	— -42	volts

\* This value can be measured by a method involving a recurrent waveform such that the maximum ratings of the tube will not be exceeded.



Horizontal-Deflection Amplifier

For operation in a 525-line, 30-frame system

MAXIMUM RATINGS (Design-Maximum Values)		
DC Plate Supply Voltage	770	volts
Peak Positive-Pulse Plate Voltage*	6500	volts
Peak Negative-Pulse Plate Voltage	-1500	volts
DC Grid-No.2 (Screen-Grid) Voltage	230	volts
DC Grid-No.1 (Control-Grid) Voltage	-55	volts
Peak Negative-Pulse Grid-No.1 Voltage	-330	volts



Peak Cathode Current .....	550	mA
Average Cathode Current .....	175	mA
Plate Dissipation* .....	17.5	watts
Grid-No.2 Input .....	3.5	watts
Bulb Temperature (At hottest point) .....	240	°C

**MAXIMUM CIRCUIT VALUES**

Grid-No.1-Circuit Resistance, For grid-resistor-bias operation ....	1	megohm
---	---	--------

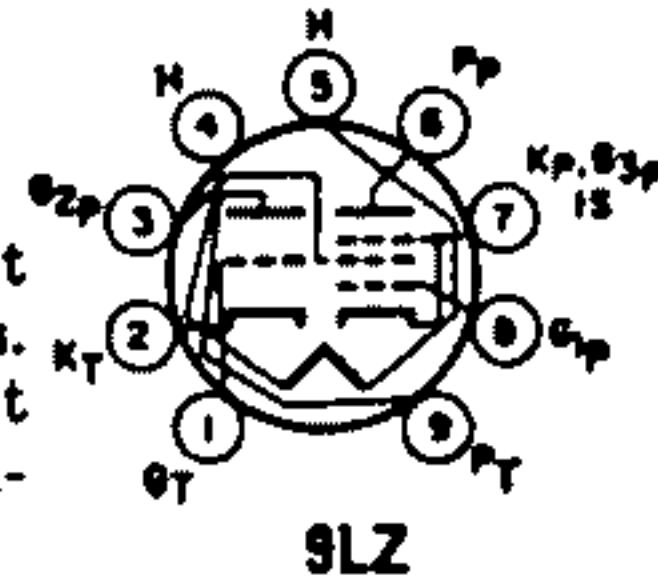
\* Pulse duration must not exceed 15% of a horizontal scanning cycle (10 microseconds).

\* A bias resistor or other means is required to protect the tube in absence of excitation.

**6GW8/  
ECL86**

**HIGH-MU TRIODE—  
SHARP-CUTOFF PENTODE**

Miniature type used in preamplifier and audio output stages of audio equipment and television receivers. Outlines section, 6G; requires miniature 9-contact socket. Heater: volts (ac/dc), 6.3; amperes, 0.7; maximum heater-cathode volts, 100 peak.



**Class A<sub>1</sub> Amplifier**

**MAXIMUM RATINGS (Design-Center Values)**

	Triode Unit	Pentode Unit	
Plate Supply Voltage .....	550	550	volts
Plate Voltage .....	300	300	volts
Grid-No.2 (Screen-Grid) Supply Voltage .....	—	550	volts
Grid-No.2 Voltage .....	—	300	volts
Grid-No.1 (Control-Grid) Voltage, Negative-bias value .....	-1.3	-1.3	volts
Cathode Current .....	4	55	mA
Plate Dissipation .....	0.5	9	watts
Grid-No.2 Input .....	—	1.5	watts

**CHARACTERISTICS**

Plate Voltage .....	250	250	volts
Grid-No.2 Voltage .....	—	250	volts
Grid-No.1 Voltage .....	-1.9	-7	volts
Amplification Factor .....	190	21*	
Plate Resistance (Approx.) .....	—	45000	ohms
Transconductance .....	1600	10000	μmhos
Plate Current .....	1.2	36	mA
Grid-No.2 Current .....	—	6	mA

**MAXIMUM CIRCUIT VALUES**

Grid-No.1-Circuit Resistance, for fixed-bias operation	1	0.5	megohm
--	---	-----	--------

\* Grid No.2 to grid No.1.

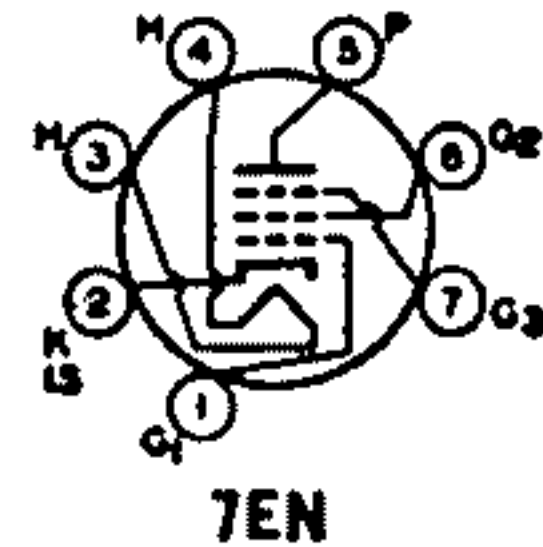
**6GY8**

Refer to chart at end of section.

**6GX6  
5GX6**

**SHARP-CUTOFF PENTODE**

Miniature type used in color and black-and-white television receivers and for FM sound-detector service in locked-oscillator, quadrature-grid FM detector circuits as combined detector, limiter, and audio-voltage driver. Tube has two independent control grids. Outlines section, 5C; requires miniature 7-contact socket. Type 5GX6 is identical with type 6GX6 except for heater ratings.



	5GX6	6GX6	
Heater Voltage (ac/dc) .....	4.7	6.3	volts
Heater Current .....	0.6	0.45	ampere
Heater Warm-up Time (Average) .....	11	11	seconds
Heater-Cathode Voltage:			
Peak value .....	±200 max	±200 max	volts
Average value .....	100 max	100 max	volts
Direct Interelectrode Capacitances (Approx.):			
Grid No.1 to Plate .....		0.026	pF
Grid No.1 to Cathode, Heater, Grid No.2, Grid No.3, and Internal Shield .....		8	pF
Grid No.1 to Grid No.3 .....		0.12	pF

Grid No.3 to Plate .....	1.6	pF
Grid No.3 to Cathode, Heater, Grid No.1, Grid No.2, Plate, and Internal Shield .....	6.5	pF

**Class A<sub>1</sub> Amplifier**

**CHARACTERISTICS**

Plate Supply Voltage .....	150	volts
Grid-No.3 Supply Voltage .....	0	volts
Grid-No.2 Supply Voltage .....	100	volts
Grid-No.1 Supply Voltage .....	0	volts
Cathode-Bias Resistor .....	180	ohms
Plate Resistance (Approx.) .....	0.14	megohm
Transconductance, grid No.1 to plate .....	3700	μmhos
Transconductance, grid No.3 to plate .....	750	μmhos
Plate Current .....	3.7	mA
Grid-No.2 Current .....	3	mA
Grid-No.3 Supply Voltage (Approx.) for plate current of 20 μA ..	-7	volts
Grid-No.1 Supply Voltage (Approx.) for plate current of 20 μA ..	-4.5	volts

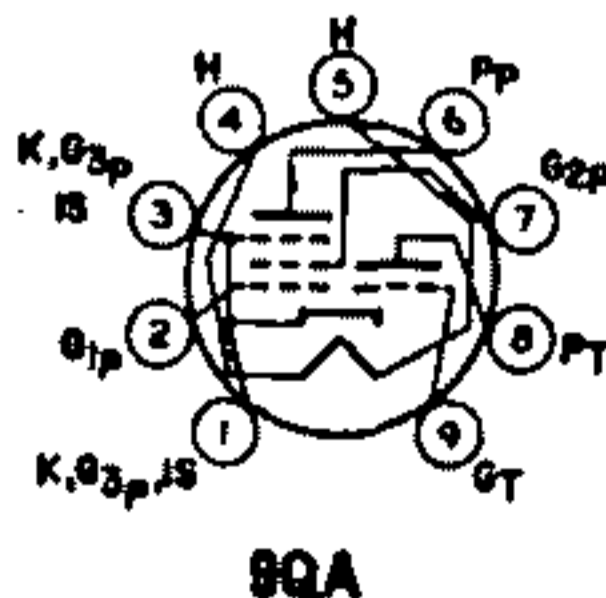
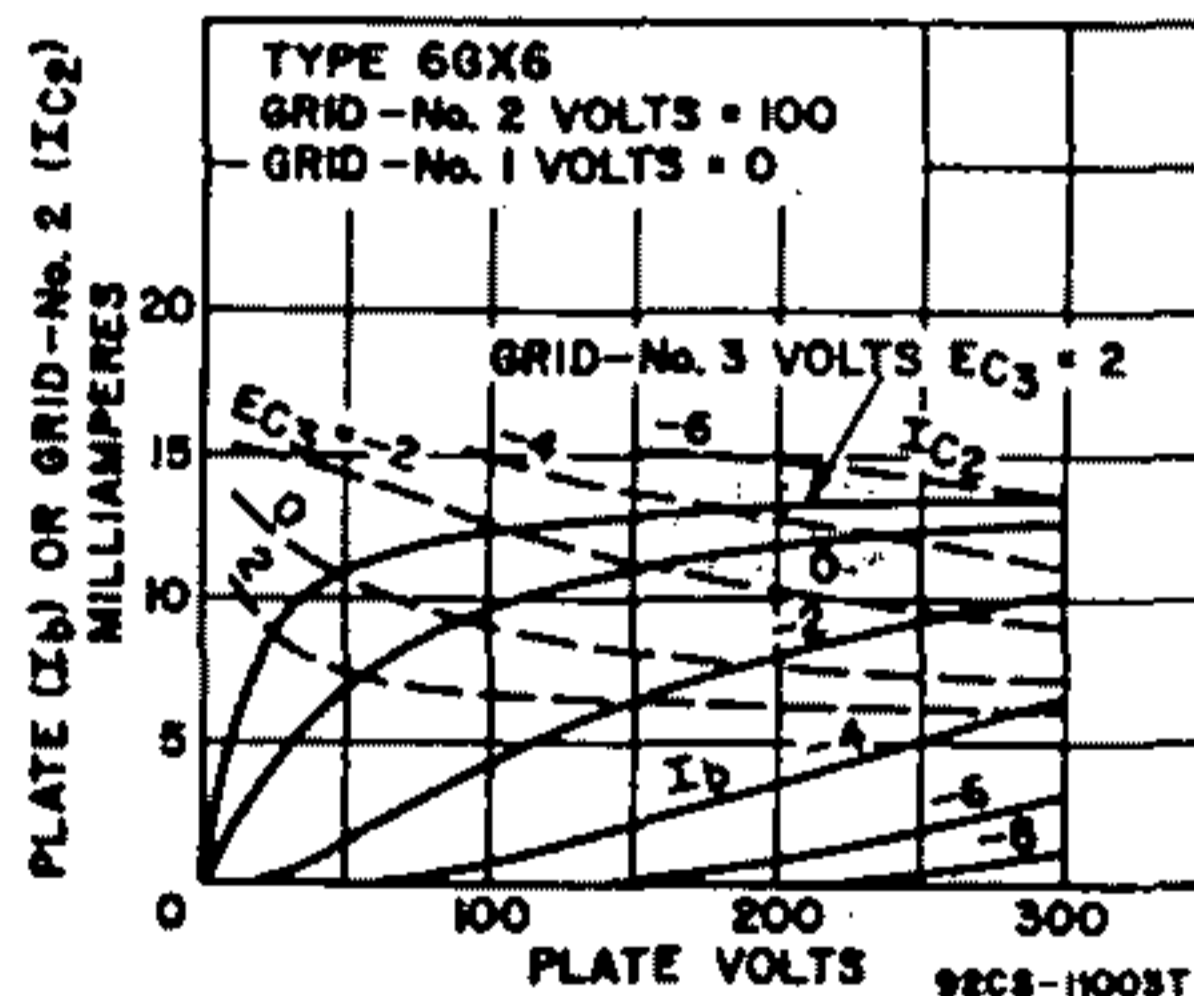
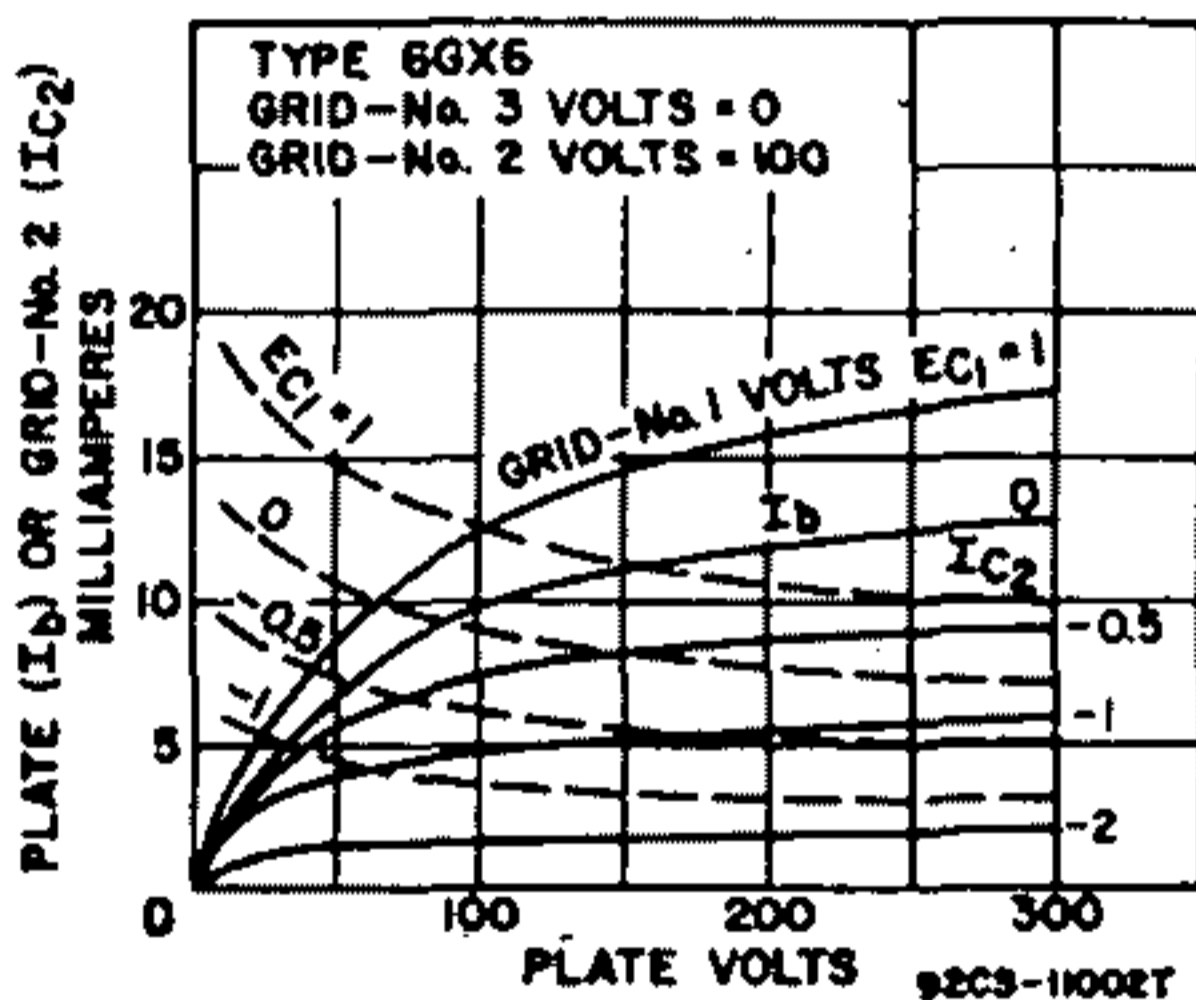
**FM Sound Detector**

**MAXIMUM RATINGS (Design-Maximum Values)**

Plate Voltage .....	300	volts
Grid-No.3 (Control-Grid) Voltage:		
Negative value (dc and peak ac) .....	-100	volts
Positive value (dc and peak ac) .....	25	volts
Grid-No.2 (Screen-Grid) Supply Voltage .....	300	volts
Grid-No.2 Voltage .....	See curve page 96	
Grid-No.1 (Control-Grid) Voltage:		
Negative-bias value .....	-50	volts
Positive-bias value .....	0	volts
Plate Dissipation .....	1.7	watts
Grid-No.3 Input .....	0.1	watt
Grid-No.2 Input:		
For grid-No.2 voltages up to 150 volts .....	1.0	watt
For grid-No.2 voltages between 150 and 300 volts .....	See curve page 96	

**MAXIMUM CIRCUIT VALUES**

Grid-No.3-Circuit Resistance .....	0.68	megohm
Grid-No.1-Circuit Resistance:		
For fixed-bias operation .....	0.22	megohm
For cathode-bias operation .....	0.47	megohm



**MEDIUM-MU TRIODE—  
SHARP-CUTOFF PENTODE**

**6GX7**  
4GX7, 5GX7

Miniature type used as combined oscillator-mixer tube in vhf tuner circuits of color and black-and-white television receivers. Outlines section, 6B; requires miniature 9-contact socket. Types 4GX7 and 5GX7 are identical with type 6GX7 except for heater ratings.

Heater Voltage (ac/dc) .....	4GX7	5GX7	6GX7	
Heater Current .....	4.2	5.6	6.3	volts
Heater Warm-up Time .....	0.6	0.45	0.4	ampere
	11	11	—	

<b>Heater-Cathode Voltage:</b>				
Peak value .....	±200 max	±200 max	±200 max	volts
Average value .....	100 max	100 max	100 max	volts
<b>Direct Interelectrode Capacitances:**</b>				
<b>Triode Unit:</b>				
Grid to Plate .....			1.2	pF
Grid to Cathode, Heater, Pentode Cathode, Grid No.3, and Internal Shield .....			2.3	pF
Plate to Cathode, Heater, Pentode Cathode, Grid No.3, and Internal Shield .....			1.9	pF
<b>Pentode Unit:</b>				
Grid No.1 to Plate .....			0.006	pF
Grid No.1 to Cathode, Heater, Grid No.2, Grid No.3, and Internal Shield .....			5.4	pF
Plate to Cathode, Heater, Grid No.2, Grid No.3, and Internal Shield .....			3.2	pF
Grid No.1 to Grid No.2 .....			1.6	pF

\*\* With external shield connected to cathode.

**Class A<sub>1</sub> Amplifier**

<b>MAXIMUM RATINGS (Design-Maximum Values)</b>				
Plate Voltage .....	Triode Unit	Pentode Unit		volts
Grid-No.2 (Screen-Grid) Supply Voltage .....	275	275		volts
Grid-No.2 Voltage .....	—	275		
Grid-No.1 (Control-Grid) Voltage:		See curve page 96		
Positive-bias value .....	0	0		
Negative-bias value .....	-40	-40		volts
Cathode Current .....	20	20		mA
Plate Dissipation .....	1.5	2.2		watts
Grid-No.2 Input:				
For grid-No.2 voltages up to 187.5 volts .....	—	0.45		watts
For grid-No.2 voltages between 137.5 and 275 volts .....	—	See curve page 96		

<b>CHARACTERISTICS</b>					
Plate Voltage .....	Triode Unit	125	Pentode Unit	125	volts
Grid-No.2 Voltage .....	—	—	90	125	volts
Grid-No.1 Voltage .....	—	-1	—	-1	volt
Grid-No.1-Circuit Resistance .....	0.1	—	0.1	—	megohm
Amplification Factor .....	40	—	—	—	
Plate Resistance .....	—	4700	—	200000	ohms
Transconductance .....	8700	8500	13000	11000	μmbos
Plate Current .....	12.5	13	8.5	8.0	mA
Grid-No.2 Current .....	—	—	2.8	2.5	mA
Grid-No.1 Voltage for plate current of 20 μA .....	-6	—	-2.5	—	volts

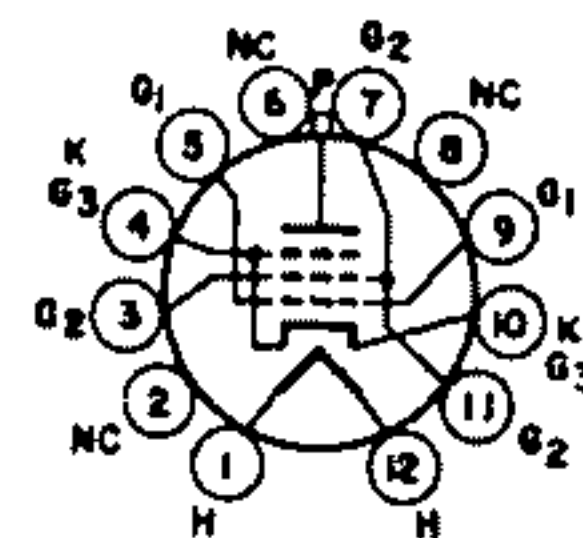
<b>MAXIMUM CIRCUIT VALUES</b>					
Grid-No.1-Circuit Resistance:			Triode Unit	Pentode Unit	
For fixed-bias operation .....			0.5	0.25	megohm
For cathode-bias operation .....			1.0	0.5	megohm

**6GY5**

16GY5, 21GY5

**BEAM POWER TUBE**

Duodecar type used as horizontal-deflection amplifier in television receivers. Outlines section, 16A; requires duodecar 12-contact socket. Types 16GY5 and 21GY5 are identical with type 6GY5 except for heater ratings.



12DR

	6GY5	16GY5	21GY5	
Heater Voltage (ac/dc) .....	6.3	15.8	21	volts
Heater Current .....	1.5	0.6	0.45	amperes
Heater Warm-up Time (Average) .....	—	11	11	seconds
<b>Heater-Cathode Voltage:</b>				
Peak value .....	±200 max	±200 max	±200 max	volts
Average value .....	100 max	100 max	100 max	volts

**Class A<sub>1</sub> Amplifier**

<b>CHARACTERISTICS</b>					
	Pentode Connection			Triode† Connection	
Plate Voltage .....	5000	60	130	130	volts
Grid-No.2 (Screen-Grid) Voltage .....	130	130	130	130	volts
Grid-No.1 (Control-Grid) Voltage .....	—	0	-20	-20	volts



Amplification Factor .....	—	—	—	4.7	
Plate Resistance (Approx.) .....	—	—	11000	—	ohms
Transconductance .....	—	—	9100	—	μmhos
Plate Current .....	—	410**	50	—	mA
Grid-No.2 Current .....	—	24**	1.75	—	mA
Grid-No.1 Voltage (Approx.) for plate current of 1 μA .....	-66	—	-33	—	volts

\*\* This value can be measured by a method involving a recurrent waveform such that the maximum ratings of the tube will not be exceeded.

† Grid No.2 tied to plate.

**Horizontal-Deflection Amplifier**

For operation in a 525-line, 30-frame system

**MAXIMUM RATINGS (Design-Maximum Values)**

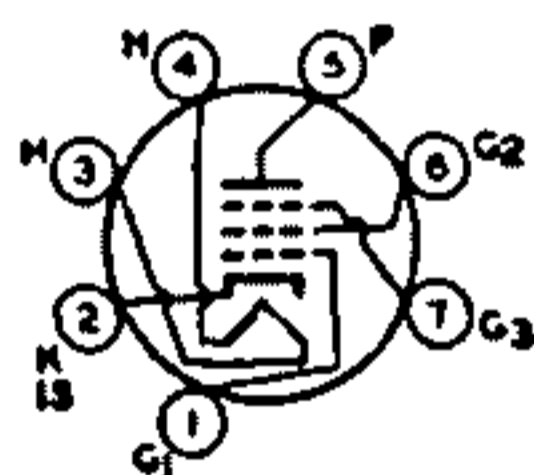
DC Plate Supply Voltage .....	770	volts
Peak Positive-Pulse Plate Voltage† .....	8500	volts
Peak Negative-Pulse Plate Voltage .....	-1500	volts
DC Grid-No.2 Voltage .....	220	volts
DC Grid-No.1 Voltage .....	-55	volts
Peak Negative-Pulse Grid-No.1 Voltage .....	-330	volts
Peak Cathode Current .....	800	mA
Average Cathode Current .....	230	mA
Plate Dissipation†† .....	18	watts
Grid-No.2 Input .....	3.5	watts
Bulb Temperature (At hottest point) .....	220	°C

**MAXIMUM CIRCUIT VALUE**

Grid-No.1-Circuit Resistance .....	1	megohm
------------------------------------	---	--------

‡ Pulse duration must not exceed 15% of a horizontal scanning cycle (10 microseconds).

†† A bias resistor or other means is required to protect the tube in absence of excitation.



7EN

**SHARP-CUTOFF PENTODE**

**6GY6**

Miniature type used in gated-agc-amplifier circuits and as a noise-inverter tube in color and black-and-white television receivers. Tube has two independent control grids. Outlines section, 5C; requires miniature 7-contact socket. For curves of average characteristics, refer to type 6GX6.

Heater Voltage (ac/dc) .....	6.3	volts
Heater Current .....	0.45	ampere
Heater Warm-up Time (Average) .....	11	seconds
Heater-Cathode Voltage:		
Peak value .....	±200 max	volts
Average value .....	100 max	volts
Direct Interelectrode Capacitances:		
Grid No.1 to Plate .....	0.026	pF
Grid No.1 to Cathode, Heater, Grid No.2, Grid No.3, and Internal Shield .....	8	pF
Grid No.1 to Grid No.3 .....	0.12	pF
Grid No.3 to Plate .....	1.6	pF
Grid No.3 to Cathode, Heater, Plate, Grid No.1, Grid No.2, and Internal Shield .....	6.6	pF

**Class A<sub>1</sub> Amplifier**

**CHARACTERISTICS**

Plate Supply Voltage .....	150	volts
Grid-No.3 Supply Voltage .....	0	volts
Grid-No.2 Supply Voltage .....	100	volts
Grid-No.1 Supply Voltage .....	0	volts
Cathode-Bias Resistor .....	180	ohms
Plate Resistance (Approx.) .....	0.14	megohm
Transconductance, Grid No.1 to Plate .....	3700	μmhos
Transconductance, Grid No.3 to Plate .....	750	μmhos
Plate Current .....	3.7	mA
Grid-No.2 Current .....	3	mA
Grid-No.3 Supply Voltage (Approx.) for plate current of 20 μA ..	-7	volts
Grid-No.1 Supply Voltage (Approx.) for plate current of 20 μA ..	-4.5	volts

**Gated AGC Amplifier and Noise Inverter**

For operation in a 525-line, 30-frame system

**MAXIMUM RATINGS (Design-Maximum Values)**

Plate Voltage	300	volts
Peak Positive-Pulse Plate Voltage*	600	volts
Grid-No.3 (Control-Grid) Voltage:		
Negative-bias value	-100	volts
Positive-bias value	0	volts
Grid-No.2 (Screen-Grid) Supply Voltage	300	volts
Grid-No.2 Voltage	See curve page 96	
Grid-No.1 (Control-Grid) Voltage:		
Negative-bias value	-50	volts
Positive-bias value	0	volts
Plate Dissipation	1.7	watts
Grid-No.2 Input:		
For grid-No.2 voltages up to 150 volts	1	watt
For grid-No.2 voltages between 150 and 300 volts	See curve page 96	

**MAXIMUM CIRCUIT VALUES**

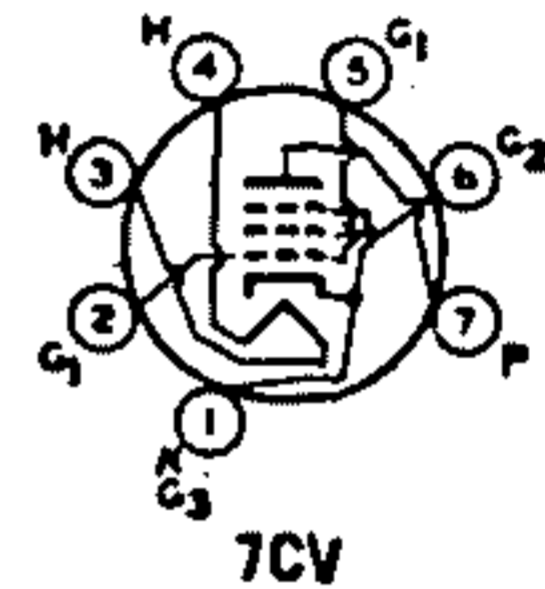
Grid-No.3-Circuit Resistance	0.68	megohm
Grid-No.1-Circuit Resistance:		
For fixed-bias operation	0.22	megohm
For cathode-bias operation	0.47	megohm

\* Pulse duration must not exceed 16% of a horizontal scanning cycle (10 microseconds).

**6GZ5**

4GZ5

**POWER PENTODE**



Miniature type used in audio output stages of radio and television receivers. Outlines section, 5C; requires miniature 7-contact socket. Type 4GZ5 is identical with type 6GZ5 except for heater ratings.

	<b>4GZ5</b>	<b>6GZ5</b>	
Heater Voltage (ac/dc)	4	6.3	volts
Heater Current	0.6	0.88	ampere
Heater Warm-up Time (Average)	11	—	seconds
Heater-Cathode Voltage:			
Peak value	±200 max	±200 max	volts
Average value	100 max	100 max	volts

**Class A<sub>1</sub> Amplifier**

**MAXIMUM RATINGS (Design-Maximum Values)**

Plate Voltage	300	volts
Grid-No.2 (Screen-Grid) Voltage	300	volts
Grid-No.1 (Control-Grid) Voltage, Positive-bias value	0	volts
Average Cathode Current	30	mA
Plate Dissipation	4.8	watts
Grid-No.2 Input	1.1	watts
Bulb temperature (At hottest point)	200	°C

**TYPICAL OPERATION**

Plate Supply Voltage	250	250	volts
Grid-No.2 Supply Voltage	250	250	volts
Cathode-Bias Resistor	270	270*	ohms
Peak AF Grid-No.1 Voltage	9.8	2	volts
Zero-Signal Plate Current	16	16	mA
Maximum-Signal Plate Current	16	16	mA
Zero-Signal Grid-No.2 Current	2.7	2.7	mA
Maximum-Signal Grid-No.2 Current	5	5	mA
Plate Resistance (Approx.)	—	0.15	megohm
Transconductance	—	8400	μmhos
Load Resistance	15000	15000	ohms
Total Harmonic Distortion	10	10	per cent
Maximum-Signal Power Output	1.8	1.1	watts

**MAXIMUM CIRCUIT VALUES**

Grid-No.1-Circuit Resistance:		
For fixed-bias operation	0.5	megohm
For cathode-bias operation	1	megohm

\* Bypassed.

**6H6**

Refer to chart at end of section.

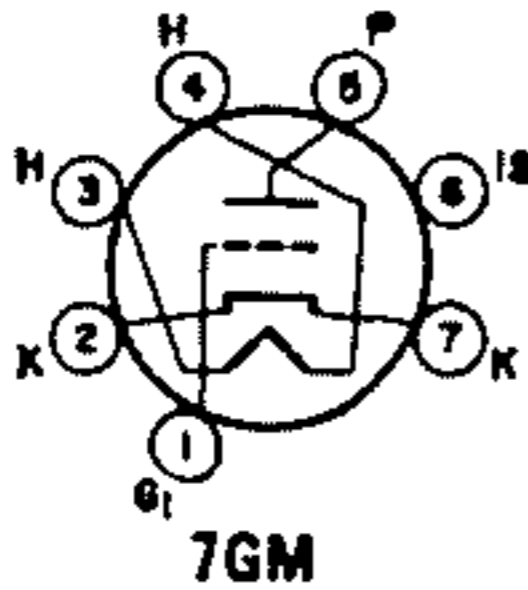
**6H6GT**

Refer to chart at end of section.

**HIGH-MU TRIODE**

**6HA5**

2HA5, 4HA5

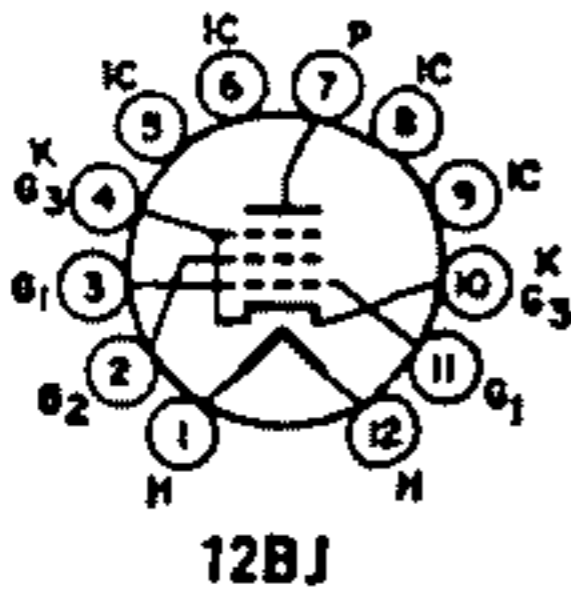


Miniature type used as rf-amplifier tube in vhf television tuners. Outlines section, 5A; requires miniature 7-contact socket. Type 6HA5 is electrically identical with type 6HM5/6HA5. Related types 2HA5 and 4HA5 are electrically identical with type 6HA5 except for heater voltages of 2.2 and 3.9 volts and heater currents of 0.6 and 0.3 ampere, respectively.

**BEAM POWER TUBE**

**6HB5**

21HB5



Duodecar type used as horizontal-deflection amplifier in television receivers. Outlines section, 15B; requires duodecar 12-contact socket. Type 21HB5 is identical with type 6HB5 except for heater ratings.

	6HB5	21HB5	
Heater Voltage (ac/dc)	6.3	21	volts
Heater Current	1.5	0.45	amperes
Heater Warm-up Time (Average)	—	11	seconds
Heater-Cathode Voltage:			
Peak value	±200 max	±200 max	volts
Average value	100 max	100 max	volts

**Class A<sub>1</sub> Amplifier**

CHARACTERISTICS	Pentode Connection		Triode* Connection	
	60	130	130	
Plate Voltage	5000	60	130	volts
Grid-No.2 (Screen-Grid) Voltage	130	130	130	volts
Grid-No.1 (Control-Grid) Voltage	—	0	-20	volts
Amplification Factor	—	—	4.7	
Plate Resistance (Approx.)	—	—	11000	ohms
Transconductance	—	—	9100	μmhos
Plate Current	—	410*	50	mA
Grid-No.2 Current	—	24*	1.75	mA
Grid-No.1 Voltage (Approx.) for plate current of 1 mA	-66	—	-33	volts

\* Grid No.2 tied to plate.

\* This value can be measured by a method involving a recurrent waveform such that the maximum ratings of the tube will not be exceeded.

**Horizontal-Deflection Amplifier**

For operation in a 525-line, 30-frame system

MAXIMUM RATINGS (Design-Maximum Values)		
DC Plate Supply Voltage	770	volts
Peak Positive-Pulse Plate Voltage†	6000	volts
Peak Negative-Pulse Plate Voltage	-1500	volts
DC Grid-No.2 Voltage	220	volts
DC Grid-No.1 Voltage	-55	volts
Peak Negative-Pulse Grid-No.1 Voltage	-330	volts
Peak Cathode Current	800	mA
Average Cathode Current	230	mA
Plate Dissipation†	18	watts
Grid-No.2 Input	3.5	watts
Bulb Temperature (At hottest point)	220	°C
MAXIMUM CIRCUIT VALUE		
Grid-No.1-Circuit Resistance	1	megohm

† Pulse duration must not exceed 15% of a horizontal scanning cycle (10 microseconds).

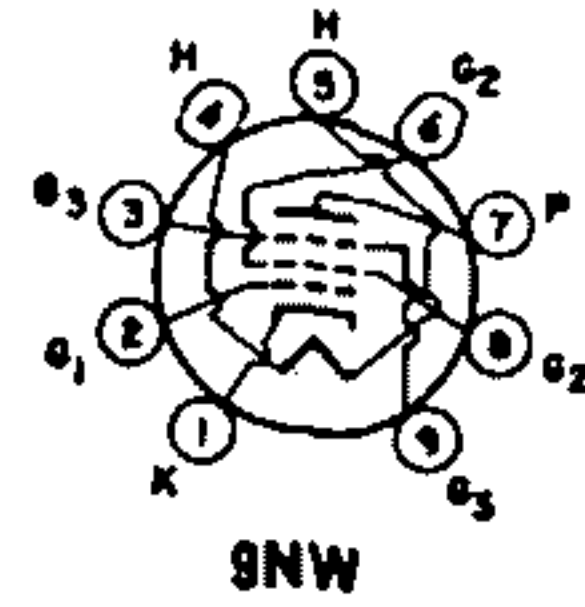
† A bias resistor or other means is required to protect the tube in absence of excitation.



**6HB6**  
15HB6

**POWER PENTODE**

Miniature type used as vertical-deflection amplifier in color and black-and-white television receivers. Outlines section, 6G; requires 9-contact socket. Type 15HB6 is identical with type 6HB6 except for heater ratings.



	6HB6	15HB6	
Heater Voltage (ac/dc)	6.3	14.7	volts
Heater Current	0.76	0.3	ampere
Heater Warm-up Time (Average)	—	11	seconds
Heater-Cathode Voltage:			
Peak value	±200 max	±200 max	volts
Average value	100 max	100 max	volts
<b>CHARACTERISTICS</b>			
Plate Supply Voltage	60	250	250
Grid No.3	—	Connected to cathode at socket	
Grid-No.2 Supply Voltage	250	126	250
Grid-No.1 Voltage	0	—	—
Cathode-Bias Resistor	—	33	100
Mu-Factor, Grid No.2 to Grid No.1	—	—	83
Plate Resistance (Approx.)	—	28000	24000
Transconductance	—	24000	20000
Plate Current	150*	40	40
Grid-No.2 Current	37*	4.2	6.2
Grid-No.1 Voltage (Approx.) for plate current of 100 μA	—	-6.4	-13

\* This value can be measured by a method involving a recurrent waveform such that the maximum ratings will not be exceeded.

**Vertical-Deflection Amplifier**

For operation in a 525-line, 30-frame system

**MAXIMUM RATINGS (Design-Maximum Values)**

DC Plate Voltage	350	volts
Peak Positive-Pulse Plate Voltage†	2500	volts
DC Grid-No.2 (Screen-Grid) Voltage	300	volts
DC Grid-No.1 (Control-Grid) Voltage	-100	volts
Plate Dissipation	10	watts
Grid-No.2 Input	2	watts

**MAXIMUM CIRCUIT VALUES**

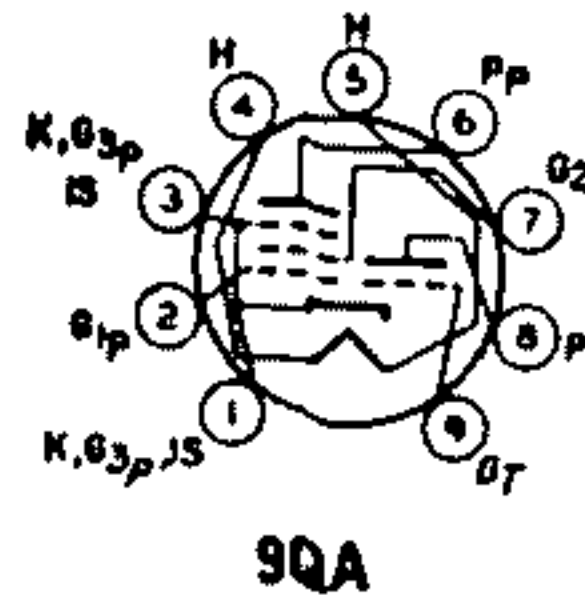
Grid-No.1-Circuit Resistance:		
For fixed-bias operation	1	megohm
For cathode-bias operation	2.2	megohms

† Pulse duration must not exceed 15% of a vertical scanning cycle (2.5 milliseconds).

**6HB7**  
5HB7

**MEDIUM-MU TRIODE—  
SHARP-CUTOFF PENTODE**

Miniature type used as combined oscillator and mixer tube in color and black-and-white television receivers utilizing an intermediate frequency in the order of 40 MHz. Outlines section, 6B; requires miniature 9-contact socket. Type 5HB7 is identical with type 6HB7 except for heater ratings.



	5HB7	6HB7	
Heater Voltage (ac/dc)	4.7	6.3	volts
Heater Current	0.6	0.45	ampere
Heater Warm-up Time (Average)	11	11	seconds
Heater-Cathode Voltage:			
Peak value	±200 max	±200 max	volts
Average value	100 max	100 max	volts
<b>Direct Interelectrode Capacitances:‡</b>			
Triode Unit:			
Grid to Plate	—	1.9	pF
Grid to Cathode, Heater, Pentode Grid No.3, and Internal Shield	—	3	pF
Plate to Cathode, Heater, Pentode Grid No.3, and Internal Shield	—	1.9	pF

Pentode Unit:

Grid No.1 to Plate .....	0.010 max	pF
Grid No.1 to Cathode, Heater, Grid No.2, Grid No.3, and Internal Shield .....	5	pF
Plate to Cathode, Heater, Grid No.2, Grid No.3, and Internal Shield .....	3.4	pF
Heater to Cathode* .....	3.8	pF

- \* With external shield connected to cathode except as noted.
- With external shield connected to ground.

**Class A<sub>1</sub> Amplifier**

**MAXIMUM RATINGS (Design-Maximum Values)**

Plate Voltage .....	330
Grid-No.2 (Screen-Grid) Supply Voltage .....	—
Grid-No.2 Voltage .....	—
Grid-No.1 (Control-Grid) Voltage:	
Positive-bias value .....	0
Plate Dissipation .....	2.5
Grid-No.2 Input:	
For grid-No.2 voltages up to 165 volts .....	—
For grid-No.2 voltages between 165 and 330 volts .....	—

Triode Unit	Pentode Unit	
330	330	volts
—	330	volts
—	See curve page 96	
0	0	volts
2.5	8.1	watts
—	0.55	watt
—	See curve page 90	

**CHARACTERISTICS**

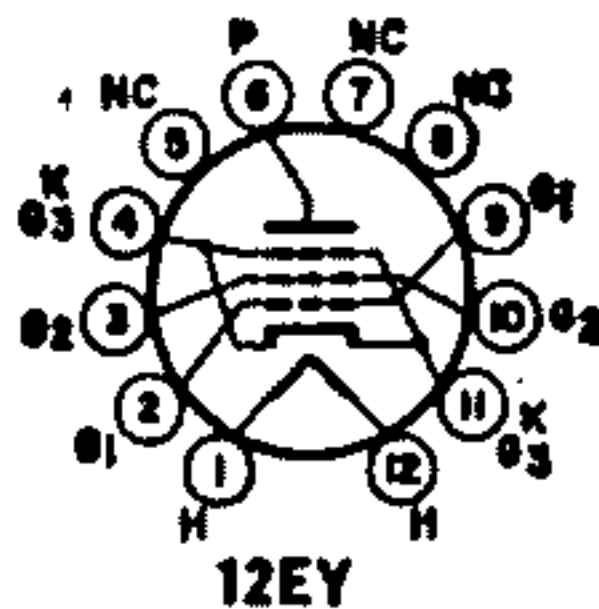
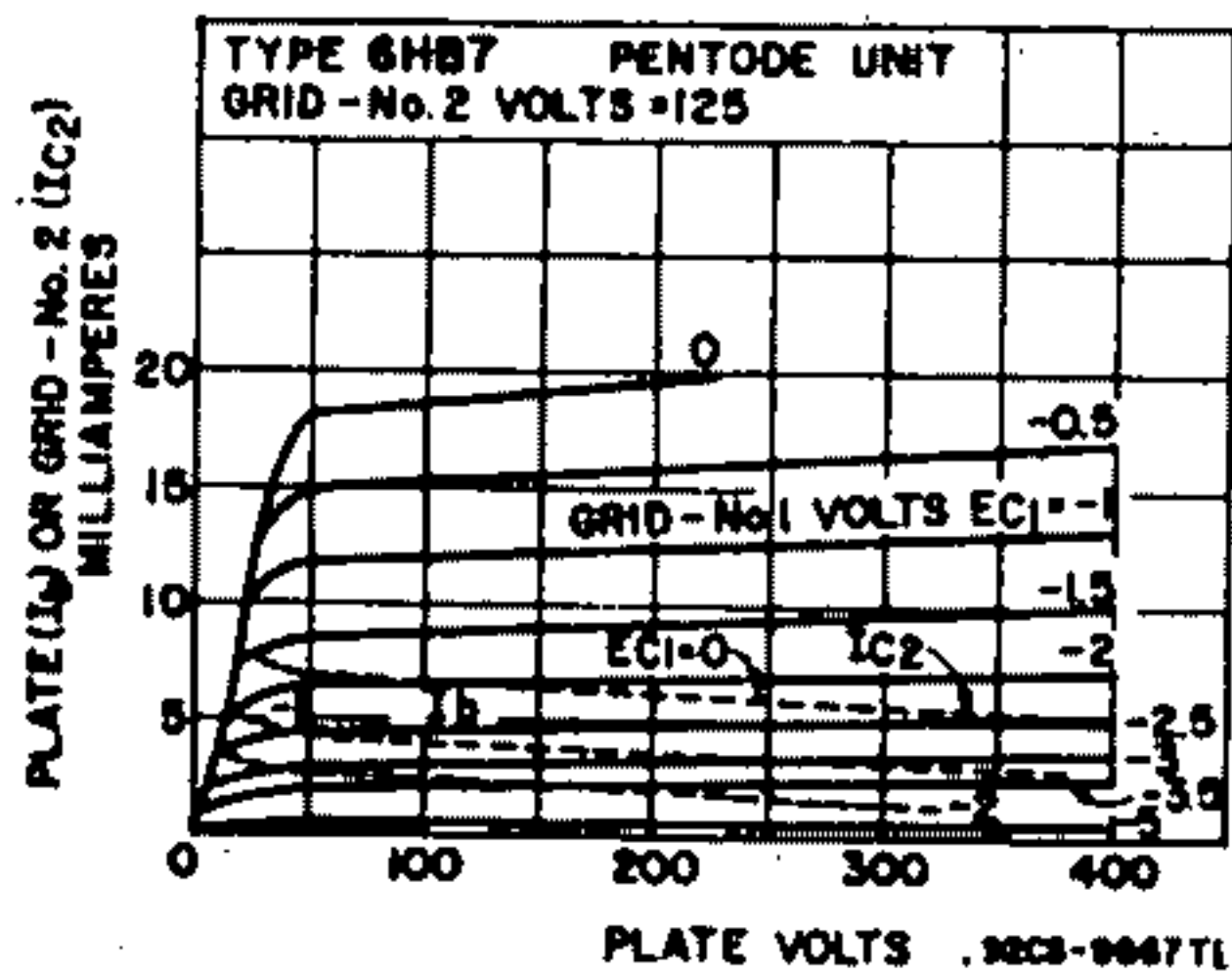
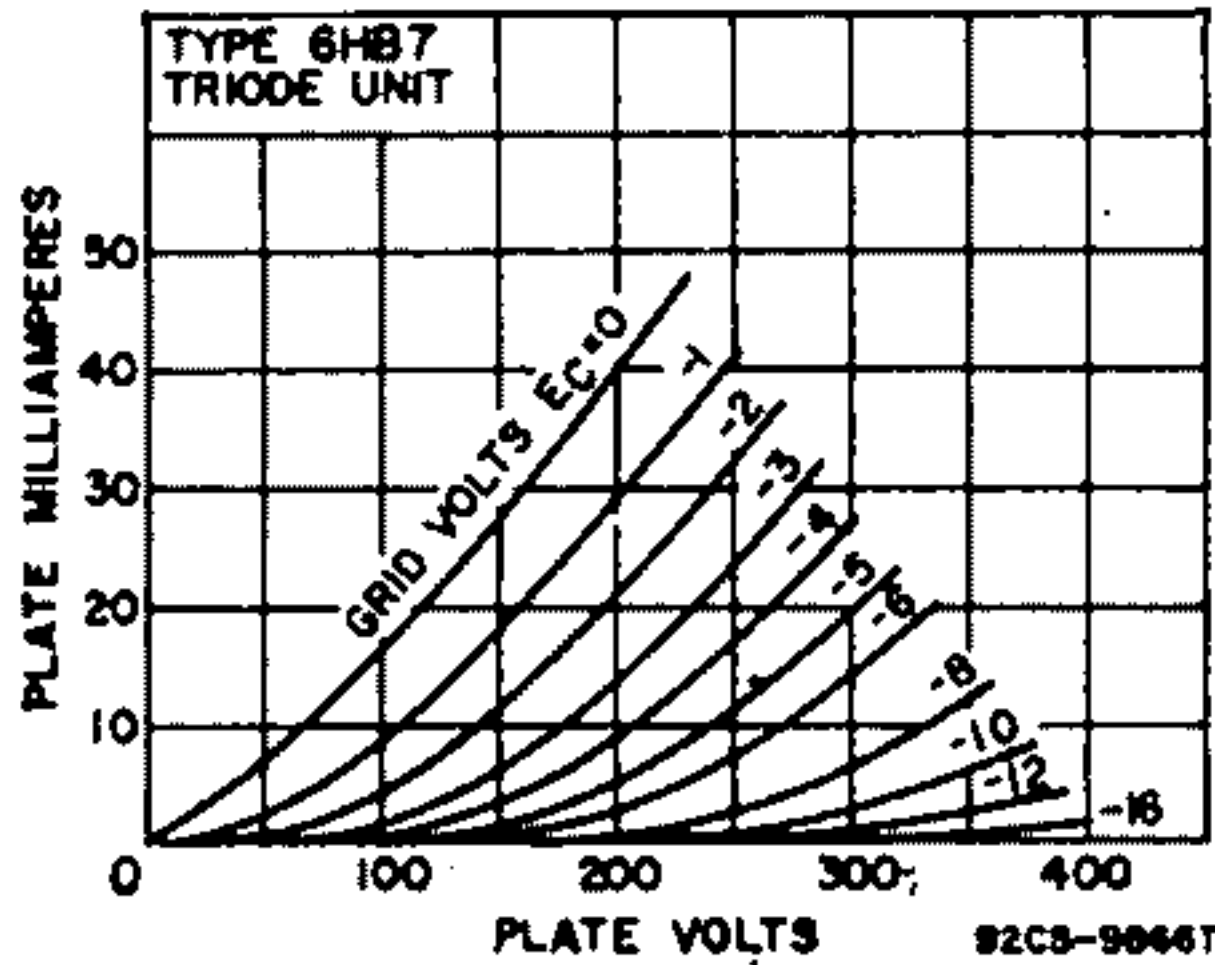
Plate Supply Voltage .....	150
Grid-No.2 Supply Voltage .....	—
Grid-No.1 Supply Voltage .....	0
Cathode-Bias Resistor .....	56
Amplification Factor .....	40
Plate Resistance (Approx.) .....	0.005
Transconductance .....	8500
Plate Current .....	18
Grid-No.2 Current .....	—
Grid-No.1 Voltage (Approx.) for plate current of 10 $\mu$ A .....	-12

125	125	volts
—	—	volts
—	-1	volts
—	—	ohms
—	—	
0.2	0.2	megohm
6400	6400	$\mu$ mhos
12	12	mA
4	4	mA
-9	-9	volts

**MAXIMUM CIRCUIT VALUES**

Grid-No.1-Circuit Resistance:	
For fixed-bias operation .....	0.5
For cathode-bias operation .....	1

0.25	0.5	megohm
—	—	megohm



**BEAM POWER TUBE**

**6HE5**

Duodecar type used as vertical-deflection amplifier in television receivers. Outlines section, 8D; requires duodecar 12-contact socket. Heater: volts (ac/dc), 6.3; amperes, 0.8; maximum heater-cathode volts,  $\pm 200$  peak, 100 average.

**Class A<sub>1</sub> Amplifier**

**CHARACTERISTICS**

Plate Voltage .....	50
Grid-No.2 (Screen-Grid) Voltage .....	250
Grid-No.1 (Control-Grid) Voltage .....	0

250	250	volts
—	—	volts
—	-20	volts

Plate Resistance (Approx.) .....	—	50000	ohms
Transconductance .....	—	4100	μmhos
Plate Current .....	180*	48	mA
Grid-No.2 Current .....	20*	3.5	mA
Grid-No.1 Voltage (Approx.) for plate current of 100 μA .....	—	—50	volts

\* This value can be measured by a method involving a recurrent waveform such that the maximum ratings of the tube will not be exceeded.

**Vertical-Deflection Amplifier**

For operation in a 525-line, 30-frame system

<b>MAXIMUM RATINGS (Design-Maximum Values)</b>			
DC Plate Voltage .....		850	volts
Peak Positive-Pulse Plate Voltage† .....		2500	volts
Grid-No.2 Voltage .....		300	volts
Peak Cathode Current .....		260	mA
Average Cathode Current .....		75	mA
Plate Dissipation† .....		12	watts
Grid-No.2 Input† .....		2.75	watts
Bulb Temperature (At hottest point) .....		200	°C
<b>MAXIMUM CIRCUIT VALUES</b>			
Grid-No.1-Circuit Resistance:			
For fixed-bias operation .....		1	megohm
For cathode-bias operation .....		2.2	megohms

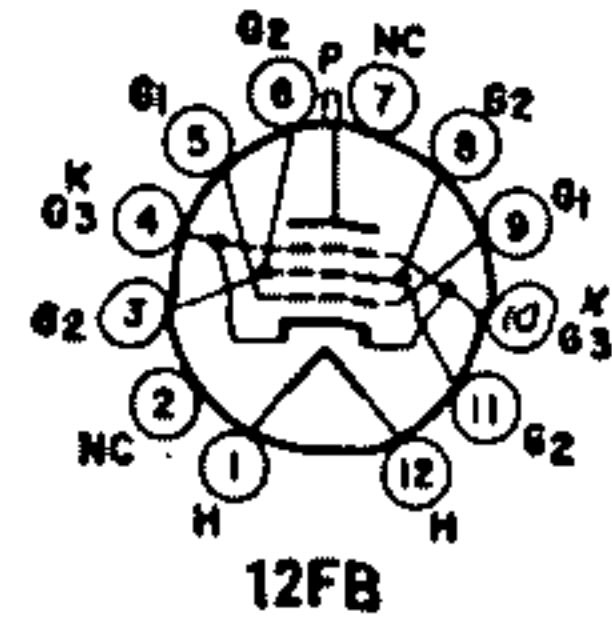
† Pulse duration must not exceed 15% of a vertical scanning cycle (2.5 milliseconds).

† A resistor or other means is required to protect the tube in absence of excitation.

**6HF5**

**BEAM POWER TUBE**

Duodecar type used as horizontal-deflection amplifier in color and black-and-white television receivers. Outlines section, 16B; requires duodecar 12-contact socket. Heater: volts (ac/dc), 6.3; amperes, 2.25; maximum heater-cathode volts, ±200 peak, 100 average.



**Class A<sub>1</sub> Amplifier**

CHARACTERISTICS	Pentode Connection			Triode Connection	
	5000	70	175	125	
Plate Voltage .....	5000	70	175	125	volts
Grid-No.2 (Screen-Grid) Voltage .....	125	125	125	125	volts
Grid-No.1 (Control-Grid) Voltage .....	—	0	—25	—25	volts
Amplification Factor .....	—	—	—	3	
Plate Resistance (Approx.) .....	—	—	5600	—	ohms
Transconductance .....	—	—	11300	—	μmhos
Plate Current .....	—	570*	125	—	mA
Grid-No.2 Current .....	—	34*	4.5	—	mA
Grid-No.1 Voltage (Approx.) for plate current of 1 mA .....	—140	—	—54	—	volts

\* Grid No.2 tied to plate.

\* This value can be measured by a method involving a recurrent waveform such that the maximum ratings of the tube will not be exceeded.

**Horizontal-Deflection Amplifier**

For operation in a 525-line, 30-frame system

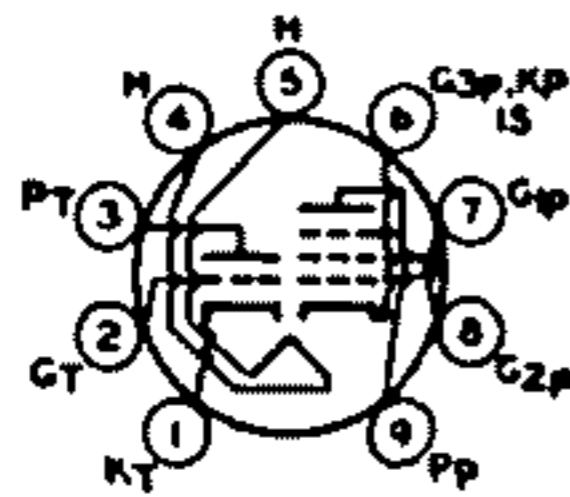
<b>MAXIMUM RATINGS (Design-Maximum Values)</b>			
DC Plate Supply Voltage .....		900	volts
Peak Positive-Pulse Plate Voltage* (Absolute Maximum) .....		7500 <sup>A</sup>	volts
Peak Negative-Pulse Plate Voltage .....		—1100	volts
DC Grid-No.2 Voltage .....		190	volts
Peak Negative-Pulse Grid-No.1 Voltage .....		—250	volts
Peak Cathode Current .....		1100	mA
Average Cathode Current .....		315	mA
Plate Dissipation† .....		28	watts
Grid-No.2 Input .....		5.5	watts
Bulb Temperature (At hottest point) .....		225	°C
<b>MAXIMUM CIRCUIT VALUE</b>			
Grid-No.1-Circuit Resistance .....		1	megohm

\* Pulse duration must not exceed 15% of a horizontal scanning cycle (10 microseconds).

<sup>A</sup> Under no circumstances should this absolute value be exceeded.

† A bias resistor or other means is required to protect the tube in absence of excitation.





**HIGH-MU TRIODE—  
SHARP-CUTOFF PENTODE**      **6HF8**  
10HF8

Miniature type used in color and black-and-white television receiver applications. The triode unit is used in high-gain, sound-if stages and in sync-separator, sync-clipper, and phase-inverter circuits; the pentode unit is used as a video-output amplifier. Outlines section, 6E; requires miniature 9-contact socket. For curves of average characteristics, refer to type 6AW8A for the triode unit and to type 6EB8 for the pentode unit. Type 10HF8 is identical with type 6HF8 except for heater ratings.

	6HF8	10HF8	
Heater Voltage (ac/dc)	6.3	10.5	volts
Heater Current	0.75	0.45	ampere
Heater Warm-up Time (Average)	—	11	seconds
Heater-Cathode Voltage:			
Peak value	±200 max	±200 max	volts
Average value	100 max	100 max	volts
Direct Interelectrode Capacitances:			
Triode Unit:			
Grid to Plate		3.5	pF
Grid to Cathode, Heater, Pentode Cathode, Grid No.3, and Internal Shield		2.8	pF
Plate to Cathode, Heater, Pentode Cathode, Grid No.2, and Internal Shield		2.6	pF
Pentode Unit:			
Grid No.1 to Plate		0.1 max	pF
Grid No.1 to Cathode, Heater, Grid No.2, Grid No.3, and Internal Shield		10	pF
Plate to Cathode, Heater, Grid No.2, Grid No.3, and Internal Shield		4.2	pF
Triode Grid to Pentode Plate		0.015 max	pF

**Class A<sub>1</sub> Amplifier**

	Triode Unit	Pentode Unit	
<b>MAXIMUM RATINGS (Design-Maximum Values)</b>			
Plate Voltage	330	330	volts
Grid-No.2 (Screen-Grid) Supply Voltage	—	330	volts
Grid-No.2 Voltage	—	See curve page 96	
Grid-No.1 (Control-Grid) Voltage, Positive-bias value	0	0	volts
Plate Dissipation	1	5	watts
Grid-No.2 Input:			
For grid-No.2 voltages up to 165 volts	—	1.1	watts
For grid-No.2 voltages between 165 and 330 volts	—	See curve page 96	

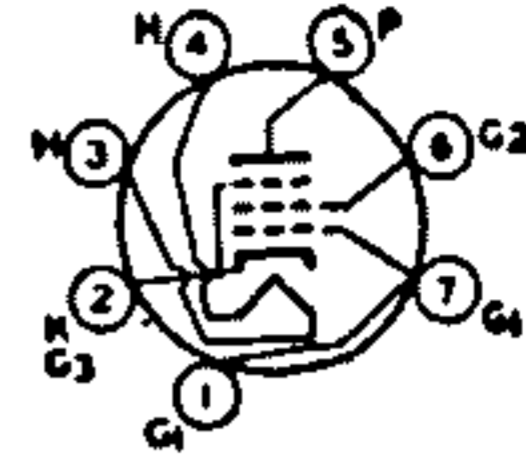
	Triode Unit	Pentode Unit	
<b>CHARACTERISTICS</b>			
Plate Supply Voltage	200	45 200	volts
Grid-No.2 Supply Voltage	—	125 125	volts
Grid-No.1 Voltage	—2	0 —	volts
Cathode-Bias Resistor	—	— 68	ohms
Amplification Factor	70	— —	
Plate Resistance (Approx.)	17500	— 76000	ohms
Transconductance	4000	— 12500	μmhos
Plate Current	4	40* 25	mA
Grid-No.2 Current	—	15* 7	mA
Grid-No.1 Voltage (Approx.) for plate current of 100 μA	—	— -9	volts
Grid-No.1 Voltage (Approx.) for plate current of 20 μA	-6	— —	volts

	Triode Unit	Pentode Unit	
<b>MAXIMUM CIRCUIT VALUES</b>			
Grid-No.1-Circuit Resistance:			
For fixed-bias operation	0.5	0.25	megohm
For cathode-bias operation	1	1	megohm

\* This value can be measured by a method involving a recurrent waveform such that the maximum ratings of the tube will not be exceeded.

# 6HG5

## BEAM POWER TUBE



7B2

Miniature type used in the audio output stages of television receivers. This type has a controlled cathode warm-up time to minimize extraneous sound during receiver warm-up. Outlines section, 5D; requires miniature 7-contact socket.

Heater Voltage (ac/dc)	6.3	volts
Heater Current	0.45	ampere
Cathode Warm-up Time*	14 min	seconds
Heater-Cathode Voltage:		
Peak value	±200 max	volts
Average value	100 max	volts
Direct Interelectrode Capacitances:		
Grid No.1 to Plate	0.4	pF
Grid No.1 to Cathode, Heater, Grid No.2, and Grid No.3	8	pF
Plate to Cathode, Heater, Grid No.2, and Grid No.3	8.5	pF

\* Time interval between application of voltages and rise of plate current to 1 mA; heater volts, 6.3; plate and grid-No.2 volts, 250; cathode-bias resistor, 680 ohms.

### Class A<sub>1</sub> Amplifier

#### MAXIMUM RATINGS (Design-Maximum Values)

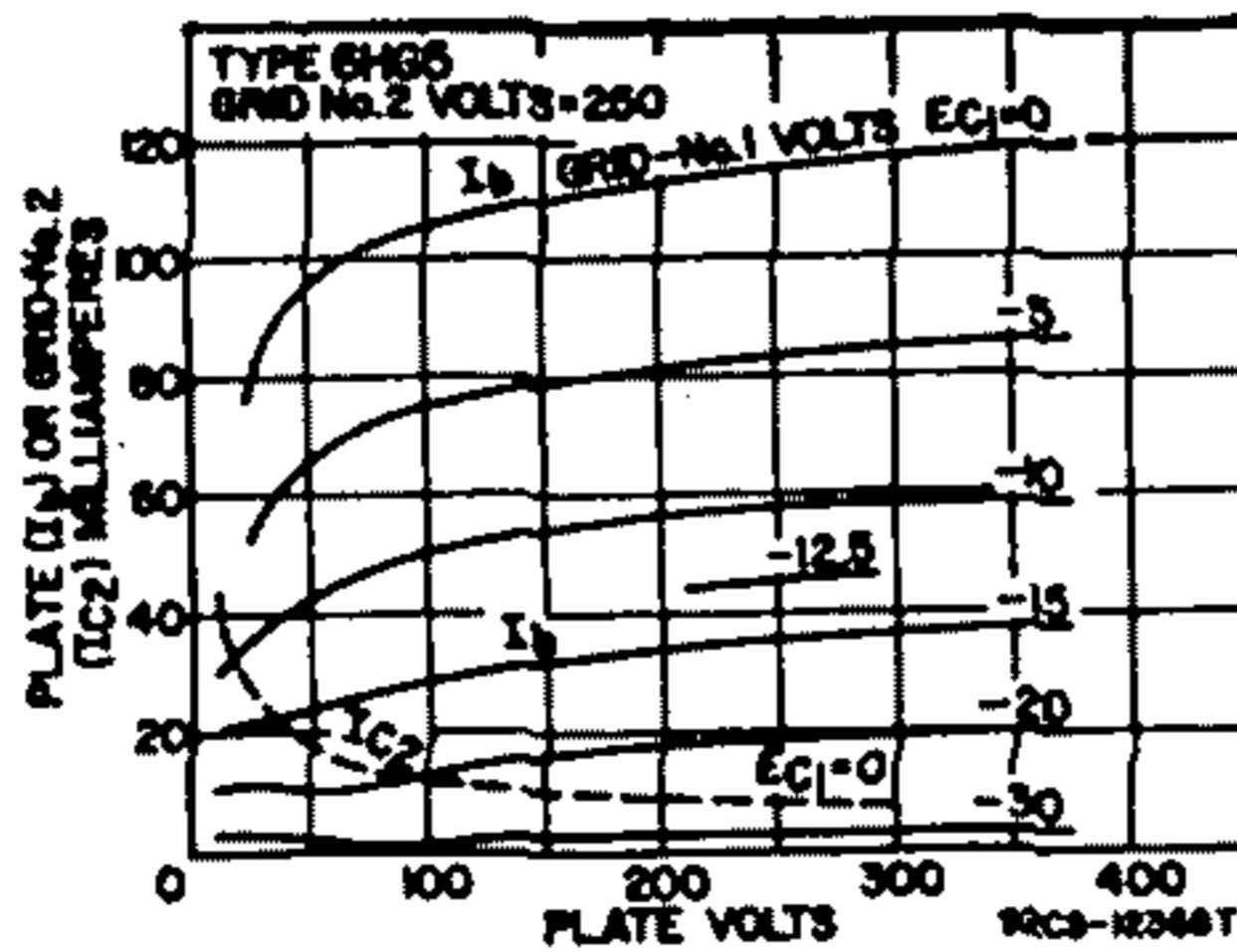
Plate Voltage	275	volts
Grid-No.2 (Screen-Grid) Voltage	275	volts
Plate Dissipation	12	watts
Grid-No.2 Input	2	watts
Bulb Temperature (At hottest point)	250	°C

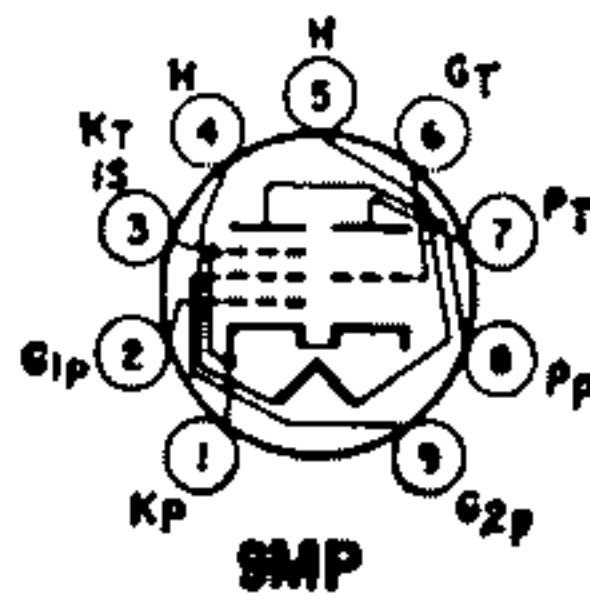
#### TYPICAL OPERATION AND CHARACTERISTICS

Plate Voltage	180	250	volts
Grid-No.2 Voltage	180	250	volts
Grid-No.1 (Control-Grid) Voltage	-8.5	-12.5	volts
Peak AF Grid-No.1 Voltage	8.5	12.5	volts
Zero-Signal Plate Current	29	46	mA
Maximum-Signal Plate Current	80	47	mA
Zero-Signal Grid-No.2 Current	8	4.5	mA
Maximum-Signal Grid-No.2 Current	4	7	mA
Plate Resistance (Approx.)	58000	52000	ohms
Transconductance	3700	4100	μmhos
Load Resistance	5500	5000	ohms
Total Harmonic Distortion	8	8	per cent
Maximum-Signal Power Output	2	4.5	watts

#### MAXIMUM CIRCUIT VALUES

Grid-No.1-Circuit Resistance:		
For fixed-bias operation	0.1	megohm
For cathode-bias operation	0.5	megohm





**MEDIUM-MU TRIODE—  
SHARP-CUTOFF PENTODE**

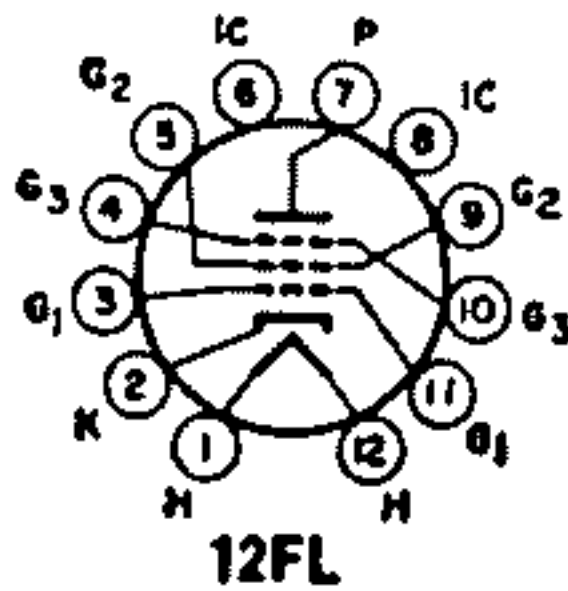
**6HG8  
6HG8/  
ECF86**  
5HG8, 7HG8  
7HG8/PCF86

Miniature types with frame-grid pentode unit used as combined oscillator and mixer tubes in vhf color and black-and-white television receivers. Outlines section, 6B; require miniature 9-contact socket. Types 5HG8, 7HG8, and 7HG8/PCF86 are identical with types 6HG8 and 6HG8/ECF86 except for slightly higher current and dissipation ratings and for heater ratings.

	5HG8	6HG8 6HG8/ ECF86	7HG8 7HG8/ PCF86	
Heater Voltage (ac/dc)	5.8	6.8	7.2	volts
Heater Current	0.45	0.84	0.8	ampere
Heater Warm-up Time (Average)	11	—	—	seconds
Peak Heater-Cathode Voltage	±100 max	±100 max	±100 max	volts

**Class A<sub>1</sub> Amplifier**

MAXIMUM RATINGS (Design-Maximum Values)	Triode Unit		Pentode Unit	
	Plate Voltage	125	250	
Grid-No.2 (Screen-Grid) Voltage	—	150		volts
Cathode Current	15	18		mA
Plate Dissipation	1.5	2		watts
Grid-No.2 Input	—	0.5		watt
<b>CHARACTERISTICS</b>				
Plate Voltage	160	170		volts
Grid-No.2 Voltage	—	150		volts
Grid-No.1 (Control-Grid) Voltage	-3	-1.2		volts
Amplification Factor	17	—		
Mu-Factor, Grid No.2 to Grid No.1	—	70		
Plate Resistance (Approx.)	—	0.35		megohm
Transconductance	5500	12000		μmhos
Plate Current	14	10		mA
Grid-No.2 Current	—	3.3		mA
<b>MAXIMUM CIRCUIT VALUES</b>				
Grid-No.1-Circuit Resistance:				
For fixed-bias operation	—	0.25		megohm
For cathode-bias operation	0.5	0.6		megohm



**BEAM POWER TUBE**

**6HJ5**  
21HJ5

Duodecar type used as horizontal-deflection amplifier in television receivers. Outlines section, 15C; requires duodecar 12-contact socket. Type 21HJ5 is identical with type 6HJ5 except for heater ratings.

	6HJ5	21HJ5	
Heater Voltage (ac/dc)	6.3	21.5	volts
Heater Current	2.25	0.6	amperes
Heater Warm-up Time (Average)	—	11	seconds
Heater-Cathode Voltage:			
Peak value	±200 max	±200 max	volts
Average value	100 max	100 max	volts

**Class A<sub>1</sub> Amplifier**

CHARACTERISTICS	Plate Voltage				
	Plate Voltage	20	40	60	135
Grid-No.2 (Screen-Grid) Voltage	110	110	135	135	volts
Grid No.3	Connected to cathode at socket				
Grid-No.1 (Control-Grid) Voltage	0	0	0	-22	volts



Triode Amplification Factor .....	—	—	—	4.2	
Plate Resistance (Approx.) .....	—	—	—	5000	ohms
Transconductance .....	—	—	—	10000	μmhos
Plate Current .....	240*	400*	540*	80	mA
Grid-No.2 Current .....	160*	42*	48*	5.5	mA
Grid-No.1 Voltage (Approx.) for plate current of 1 mA .....	—	—	—	-70	volts

\* This value can be measured by a method involving a recurrent waveform such that the maximum ratings of the tube will not be exceeded.

**Horizontal-Deflection Amplifier**

For operation in a 525-line, 30-frame system

**MAXIMUM RATINGS (Design-Maximum Values)**

DC Plate Supply Voltage .....	770	volts
Peak Positive-Pulse Plate Voltage† .....	7000	volts
Peak Negative-Pulse Plate Voltage .....	-1500	volts
DC Grid-No.3 Voltage .....	70	volts
DC Grid-No.2 Voltage .....	220	volts
Peak Negative-Pulse Grid-No.1 Voltage .....	-330	volts
Peak Cathode Current .....	1000	mA
Average Cathode Current .....	280	mA
Plate Dissipation† .....	24	watts
Grid-No.2 Input .....	6	watts
Grid-No.2 Input (Warm-up Surge)* .....	12	watts
Bulb Temperature (At hottest point) .....	240	°C

**MAXIMUM CIRCUIT VALUE**

Grid-No.1-Circuit Resistance .....	1	megohm
------------------------------------	---	--------

‡ Pulse duration must not exceed 15% of a horizontal scanning cycle (10 microseconds).

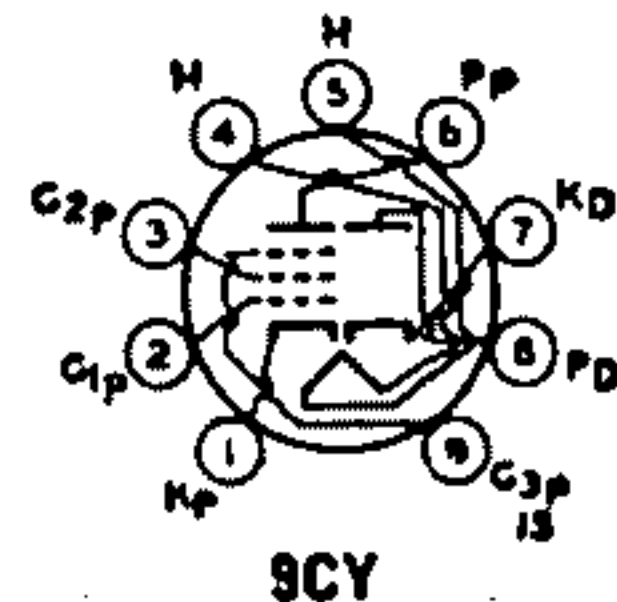
† A bias resistor or other means is required to protect the tube in absence of excitation.

\* Surge not to exceed 15-second duration.

**6HJ8**

**DIODE—  
SHARP-CUTOFF PENTODE**

Miniature type used as combined video-detector and if-amplifier tube in television receivers. Outlines section, 6B; requires miniature 9-contact socket.



Heater Voltage (ac/dc) .....	6.3	volts
Heater Current .....	0.45	ampere
Heater Warm-up Time (Average) .....	11	seconds
Peak Heater-Cathode Voltage .....	±200 max	volts
Direct Interelectrode Capacitances:		
Diode Unit:		
Plate to Cathode and Heater .....	2.4	pF
Cathode to Plate and Heater .....	3	pF
Pentode Unit:		
Grid No.1 to Plate .....	0.016 max	pF
Grid No.1 to Cathode, Heater, Grid No.2, Grid No.3, and Internal Shield .....	7	pF
Plate to Cathode, Heater, Grid No.2, Grid No.3, and Internal Shield .....	3.2	pF
Diode Plate to Pentode Grid No.1 .....	0.005 max	pF
Diode Cathode to Pentode Plate .....	0.15 max	pF
Diode Plate to Pentode Plate .....	0.035 max	pF

**Pentode Unit as Class A<sub>1</sub> Amplifier**

**MAXIMUM RATINGS (Design-Maximum Values)**

Plate Voltage .....	330	volts
Grid-No.2 (Screen-Grid) Supply Voltage .....	330	volts
Grid-No.2 Voltage .....	See curve page 96	
Grid-No.1 (Control-Grid) Voltage, Positive-bias value .....	0	volts
Plate Dissipation .....	3.2	watts
Grid-No.2 Input:		
For grid-No.2 voltages up to 165 volts .....	0.55	watt
For grid-No.2 voltages between 165 and 330 volts .....	See curve page 96	

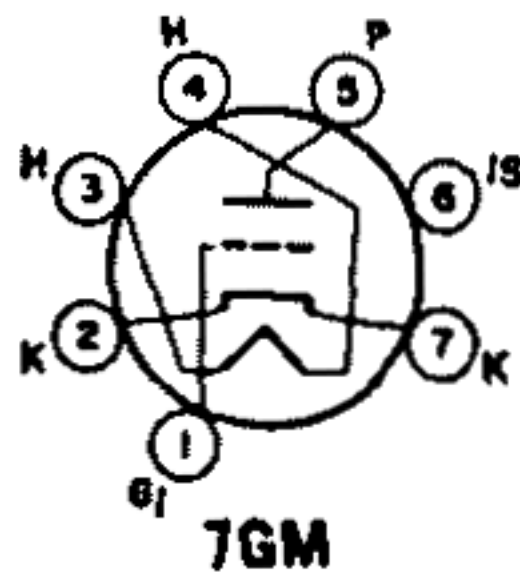
**CHARACTERISTICS**

Plate Dissipation .....		
Plate Supply Voltage .....	125	volts
Grid No.3 .....	Connected to cathode at socket	
Grid-No.2 Supply Voltage .....	125	volts

Cathode-Bias Resistor .....	58	ohms
Plate Resistance (Approx.) .....	0.2	megohm
Transconductance .....	9300	$\mu$ mbos
Plate Current .....	11.5	mA
Grid-No.2 Current .....	3.6	mA
Grid-No.1 Voltage (Approx.) for plate current of 20 $\mu$ A .....	-6	volts
Grid-No.1 Voltage (Approx.) for plate current of 2 mA .....	-3	volts

**Diode Unit**

<b>MAXIMUM RATINGS (Design-Maximum Values)</b>		
DC Plate Current .....	5	mA
<b>CHARACTERISTICS, Instantaneous Value</b>		
Tube Voltage Drop for plate current of 50 mA .....	10	volts



**HIGH-MU TRIODE**

**6HK5**

Miniature type with frame grid used in vhf tuners of television receivers. Outlines section, 5C; requires miniature 7-contact socket.

Heater Voltage (ac/dc) .....	6.3	volts
Heater Current .....	0.19	ampere
Peak Heater-Cathode Voltage .....	$\pm 100$ max	volts
<b>Direct Interelectrode Capacitances:*</b>		
Grid to Plate .....	0.29	pF
Grid to Cathode, Heater, and Internal Shield .....	4.4	pF
Plate to Cathode, Heater, and Internal Shield .....	2.6	pF
Heater to Cathode .....	2.5	pF

\* With external shield.

**Class A<sub>1</sub> Amplifier**

<b>MAXIMUM RATINGS (Design-Maximum Values)</b>		
Plate Voltage .....	200	volts
Grid Voltage, Negative-bias Value .....	-50	volts
Cathode Current .....	22	mA
Plate Dissipation .....	2.3	watts
<b>CHARACTERISTICS</b>		
Plate Voltage .....	135	volts
Grid Voltage .....	-1	volt
Amplification Factor .....	75	
Plate Resistance (Approx.) .....	5000	ohms
Transconductance .....	15000	$\mu$ mbos
Plate Current .....	12.5	mA
Input Resistance** .....	600	ohms
Input Capacitance** .....	9	pF
Noise Figure# .....	4.2	dB
Grid Voltage (Approx.) for transconductance of 150 $\mu$ mbos .....	-6	volts
Grid Voltage (Approx.) for transconductance of 1500 $\mu$ mbos .....	-2.8	volts

**MAXIMUM CIRCUIT VALUE**

Grid-Circuit Resistance, for cathode-bias operation .....	1	megohm
---	---	--------

\*\* Measured at 200 MHz with plate effectively grounded for rf voltages.

# For a neutralized triode amplifier at a frequency of 200 MHz with signal source impedance adjusted for minimum noise output.

**MEDIUM-MU TRIODE—  
SHARP-CUTOFF PENTODE**

**6HL8**



Miniature type used in color and black-and-white television receiver applications. The triode unit is used as a sync-separator or voltage-amplifier tube, and the pentode unit is used as a video if-amplifier, agc-amplifier, or reactance tube. Outlines section, 6B; requires miniature 9-contact socket. Heater: volts (ac/dc), 6.3; amperes, 0.6; warm-up time (average), 11 seconds; maximum heater-cathode volts,  $\pm 200$  peak, 100 average.



**Class A<sub>1</sub> Amplifier**

MAXIMUM RATINGS (Design-Maximum Values)		Triode Unit	Pentode Unit	
Plate Voltage		220	220	volts
Grid-No.2 (Screen-Grid) Supply Voltage		—	220	volts
Grid-No.2 Voltage		See curve page 96		
Grid-No.1 (Control-Grid) Voltage, Positive-bias value		0	0	volts
Plate Dissipation		2.5	2.5	watts
Grid-No.2 Input:				
For grid-No.2 voltages up to 165 volts		—	0.55	watt
For grid-No.2 voltages between 165 and 220 volts		—	See curve page 96	

**CHARACTERISTICS**

Plate Voltage	125	125	volts
Grid-No.2 Voltage	—	125	volts
Grid-No.1 Voltage	—1	—1	volt
Amplification Factor	40	—	
Plate Resistance (Approx.)	5000	150000	ohms
Transconductance	7000	10000	$\mu$ mhos
Plate Current	12.5	12	mA
Grid-No.2 Current	—	4.5	mA
Grid-No.1 Voltage (Approx.) for plate current of 20 $\mu$ A	—	—7	volts

**MAXIMUM CIRCUIT VALUE**

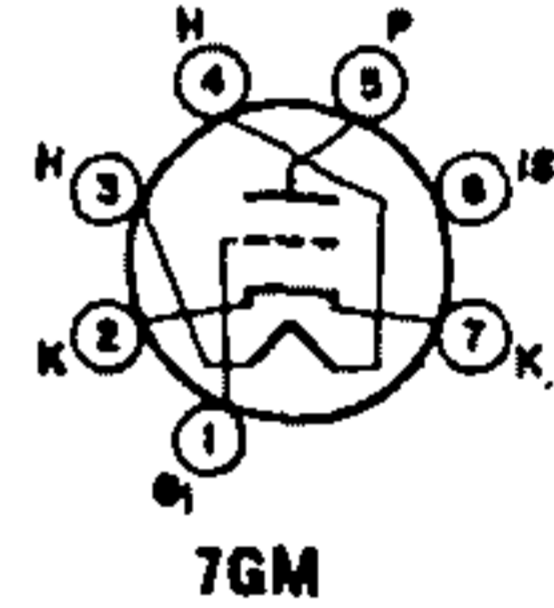
Grid-No.1-Circuit Resistance		megohm
------------------------------	--	--------

**6HM5/  
6HA5**

3HM5/3HA5

**HIGH-MU TRIODE**

Miniature type used as rf-amplifier tube in vhf color and black-and-white television tuners. Outlines section, 5C; requires miniature 7-contact socket. Type 3HM5/3HA5 is identical with type 6HM5/6HA5 except for heater ratings.



	3HM5/3HA5	6HM5/6HA5	
Heater Voltage (ac/dc)	2.7	6.3	volts
Heater Current	0.45	0.18	ampere
Peak Heater-Cathode Voltage	$\pm 110$ max	$\pm 110$ max	volts
Direct Interelectrode Capacitances:			
Grid to Plate		0.36	pF
Grid to Cathode, Heater, Internal Shield, and External Shield		4.3	pF
Plate to Cathode, Heater, Internal Shield, and External Shield		0.080	pF
Cathode to Plate		2.9	pF
Cathode to Heater, Grid, Internal Shield, and External Shield		3.1	pF
Heater to Cathode		2.3	pF
Heater to Grid		0.070 max	pF

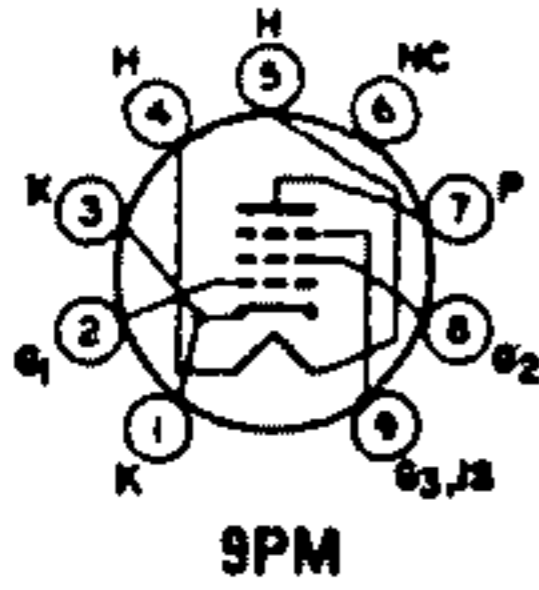
**Class A<sub>1</sub> Amplifier**

MAXIMUM RATINGS (Design-Maximum Values)		
DC Plate Voltage		220 volts
DC Plate Supply Voltage		600 volts
Grid Voltage		—50 volts
Cathode Current		22 mA
Plate Dissipation		2.6 watts

**CHARACTERISTICS AND TYPICAL OPERATION**

	Fixed Bias		Cathode Bias		
	135	135	135	135	
DC Plate Supply Voltage	—	—	1000	5600	ohms
Plate-Load Resistor	0	0	0	0	volts
Internal-Shield Voltage	—1	—2.7	—	—	volts
DC Grid Voltage	—	—	0	87	ohms
Cathode-Bias Resistor	72	—	80	72	
Amplification Factor	14500	1500	20000	14500	$\mu$ mhos
Transconductance	11.6	—	19	11.5	mA
Plate Current	—	—	10	—	$\mu$ A
DC Grid Current	—	—	—5.3	—8.1	volts
Grid-No.1 Voltage for one-per-cent transconductance					





**SHARP-CUTOFF PENTODE**

**6HM6**

4HM6

Miniature type with frame grid used in the if-amplifier stages of television receivers. Outlines section, 6B; requires miniature 9-contact socket. Type 4HM6 is identical with type 6HM6 except for heater ratings.

	4HM6	6HM6	
Heater Voltage (ac/dc)	4.2	6.8	volts
Heater Current	0.45	0.3	ampere
Heater Warm-up Time (Average)	11	—	seconds
Heater-Cathode Voltage:			
Peak value	±200 max	±200 max	volts
Average value	100 max	100 max	volts
Direct Interelectrode Capacitances:			
Grid No.1 to Plate	0.081	0.024	pF
Grid No.1 to Cathode, Heater, Grid No.2, Grid No.3, and Internal Shield	8.7	8.7	pF
Plate to Cathode, Heater, Grid No.2, Grid No.3, and Internal Shield	2.15	3.0	pF

**Class A<sub>1</sub> Amplifier**

**MAXIMUM RATINGS (Design-Maximum Values)**

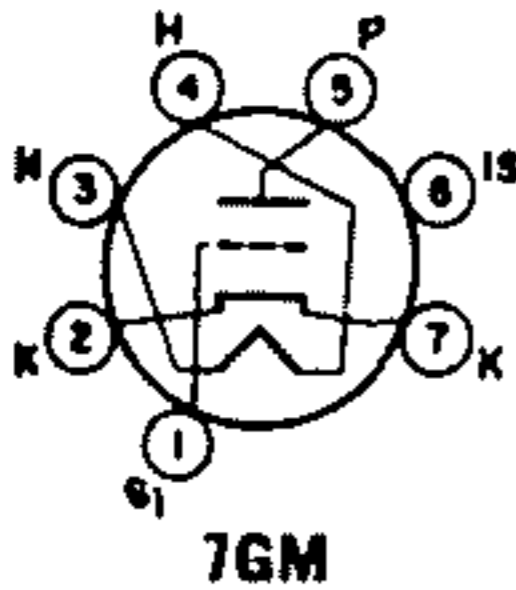
Plate Voltage	250	volts
Grid-No.2 (Screen-Grid) Supply Voltage	250	volts
Grid-No.2 Voltage	See curve page 96	
Grid-No.1 (Control-Grid) Voltage, Negative-bias value	-50	volts
Cathode Current	25	mA
Plate Dissipation	2.5	watts
Grid-No.2 Input:		
For grid-No.2 voltages up to 125 volts	2.5	watts
For grid-No.2 voltages between 125 and 250 volts	See curve page 96	

**CHARACTERISTICS**

Plate Supply Voltage	125	volts
Grid No.3 (Suppressor Grid)	Connected to cathode at socket	
Grid-No.2 Supply Voltage	125	volts
Cathode-Bias Resistor	56	ohms
Plate Resistance (Approx.)	0.156	megohm
Transconductance	15000	μmhos
Plate Current	18	mA
Grid-No.2 Current	3.2	mA
Grid-No.1 Voltage (Approx.) for transconductance of 100 μmhos	-8	volts

**MAXIMUM CIRCUIT VALUES**

Grid-No.1-Circuit Resistance:		
For fixed-bias operation	0.25	megohm
For cathode-bias operation	1	megohm



**HIGH-MU TRIODE**

**6HQ5**

2HQ5, 3HQ5

Miniature type used as grounded-cathode rf-amplifier tube in vhf tuners of television receivers. Outlines section, 5C; requires miniature 7-contact socket. Types 2HQ5 and 3HQ5 are identical with type 6HQ5 except for heater ratings.

	2HQ5	3HQ5	6HQ5	
Heater Voltage (ac/dc)	2.4	3	6.8	volts
Heater Current	0.6	0.45	0.2	ampere
Heater Warm-up Time (Average)	11	11	—	seconds
Peak Heater-Cathode Voltage	±100	±100	±100	volts
Direct Interelectrode Capacitances (Approx.):*				
Grid to Plate			0.52	pF
Grid to Cathode, Heater, and Internal Shield			5	pF
Plate to Cathode, Heater, and Internal Shield			3.5	pF
Heater to Cathode			2.5	pF

\* With external shield connected to cathode.

**Class A<sub>1</sub> Amplifier**

<b>MAXIMUM RATINGS (Design-Maximum Values)</b>		
Plate Voltage .....	200	volts
Grid Voltage, Negative-bias Value .....	-50	volts
Cathode Current .....	22	mA
Plate Dissipation .....	2.5	watts
<b>CHARACTERISTICS</b>		
Plate Voltage .....	185	volts
Grid Voltage .....	-1	volt
Amplification Factor .....	78	
Plate Resistance .....	5400	ohms
Transconductance .....	15000	$\mu$ mbos
Plate Current .....	11.6	mA
Input Resistance** .....	275	ohms
Input Capacitance** .....	11.2	pF
Noise Figures# .....	4.7	dB
Grid Voltage (Approx.) for transconductance of 150 $\mu$ mbos .....	-4.2	volts
Grid Voltage (Approx.) for transconductance of 1500 $\mu$ mbos .....	-2.5	volts

<b>MAXIMUM CIRCUIT VALUE</b>		
Grid-Circuit Resistance, for cathode-bias operation .....	1	megohm

\*\* Measured at 200 MHz with heater volts = 6.3 volts and plate effectively grounded for rf voltages.  
 # For a neutralized triode amplifier at a frequency of 200 MHz with signal source impedance adjusted for minimum noise output.

**6HR5 BEAM POWER TUBE**

Miniature type used as vertical-deflection amplifier in television receivers. Outlines section, 5D; requires miniature 7-contact socket.



7B2

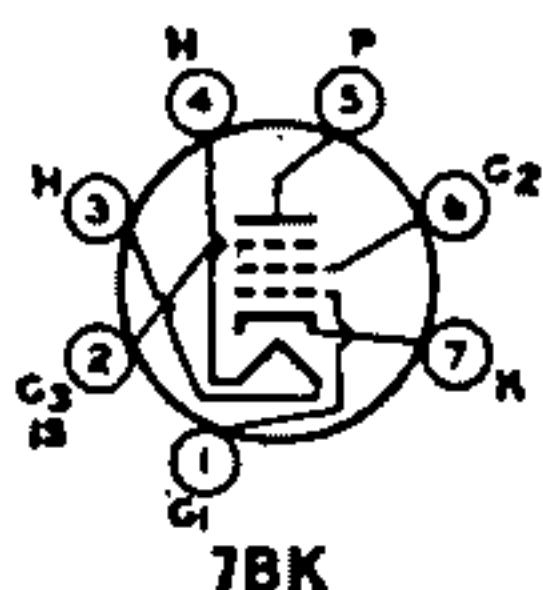
Heater Voltage (ac/dc) .....	6.3	volts
Heater Current .....	0.46	ampere
Heater Warm-up Time (Average) .....	11	seconds
<b>Heater-Cathode Voltage:</b>		
Peak value .....	$\pm 200$ max	volts
Average value .....	100 max	volts
<b>Direct Interelectrode Capacitances:</b>		
Grid No.1 to Plate .....	0.35	pF
Grid No.1 to Cathode, Heater, Grid No.2, and Grid No.3 .....	8.2	pF
Plate to Cathode, Heater, Grid No.2, and Grid No.3 .....	8.2	pF

**Vertical-Deflection Amplifier**

For operation in a 525-line, 30-frame system

<b>MAXIMUM RATINGS (Design-Maximum Values)</b>			
Plate Voltage .....	260	volts	
Peak Positive-Pulse Plate Voltage# (Absolute Maximum) .....	1500	volts	
Grid-No.2 (Screen-Grid) Voltage .....	270	volts	
Peak Negative-Pulse Grid-No.1 Voltage .....	-150	volts	
Plate Dissipation .....	8	watts	
Peak Cathode Current .....	125	mA	
Average Cathode Current .....	35	mA	
Grid-No.2 Input .....	2	watts	
<b>CHARACTERISTICS</b>			
Plate Voltage .....	50	260	volts
Grid-No.2 Voltage .....	250	270	volts
Grid-No.1 Voltage .....	0	-19	volts
Transconductance .....	-	3600	$\mu$ mbos
Plate Current .....	105	30	mA
Grid-No.2 Current .....	25	2.3	mA
Grid-No.1 Voltage (Approx.) for plate current of 100 $\mu$ A .....	-	-43	volts
<b>MAXIMUM CIRCUIT VALUE</b>			
Grid-No.1-Circuit Resistance .....	2.2	megohms	

# Pulse duration must not exceed 15% of a vertical scanning cycle (2.5 milliseconds).



**SEMIREMOTE-CUTOFF  
PENTODE**

**6HR6  
19HR6**

Miniature type used as if-amplifier tube in FM receivers. Outlines section, 5C; requires miniature 7-contact socket. Type 19HR6 is identical with type 6HR6 except for heater ratings.

	6HR6	19HR6	
Heater Voltage (ac/dc)	6.3	18.9	volts
Heater Current	0.45	0.15	ampere
Heater Warm-up Time (Average)	11	17	seconds
Heater-Cathode Voltage:			
Peak value	±200 max	±200 max	volts
Average value	100 max	100 max	volts
Direct Interelectrode Capacitances:			
Grid No.1 to Plate		0.006 max	pF
Grid No.1 to Cathode, Heater, Grid No.2, Grid No.3, and Internal Shield		8.8	pF
Plate to Cathode, Heater, Grid No.2, Grid No.3, and Internal Shield		5.2	pF

**Class A<sub>1</sub> Amplifier**

**MAXIMUM RATINGS (Design-Maximum Values)**

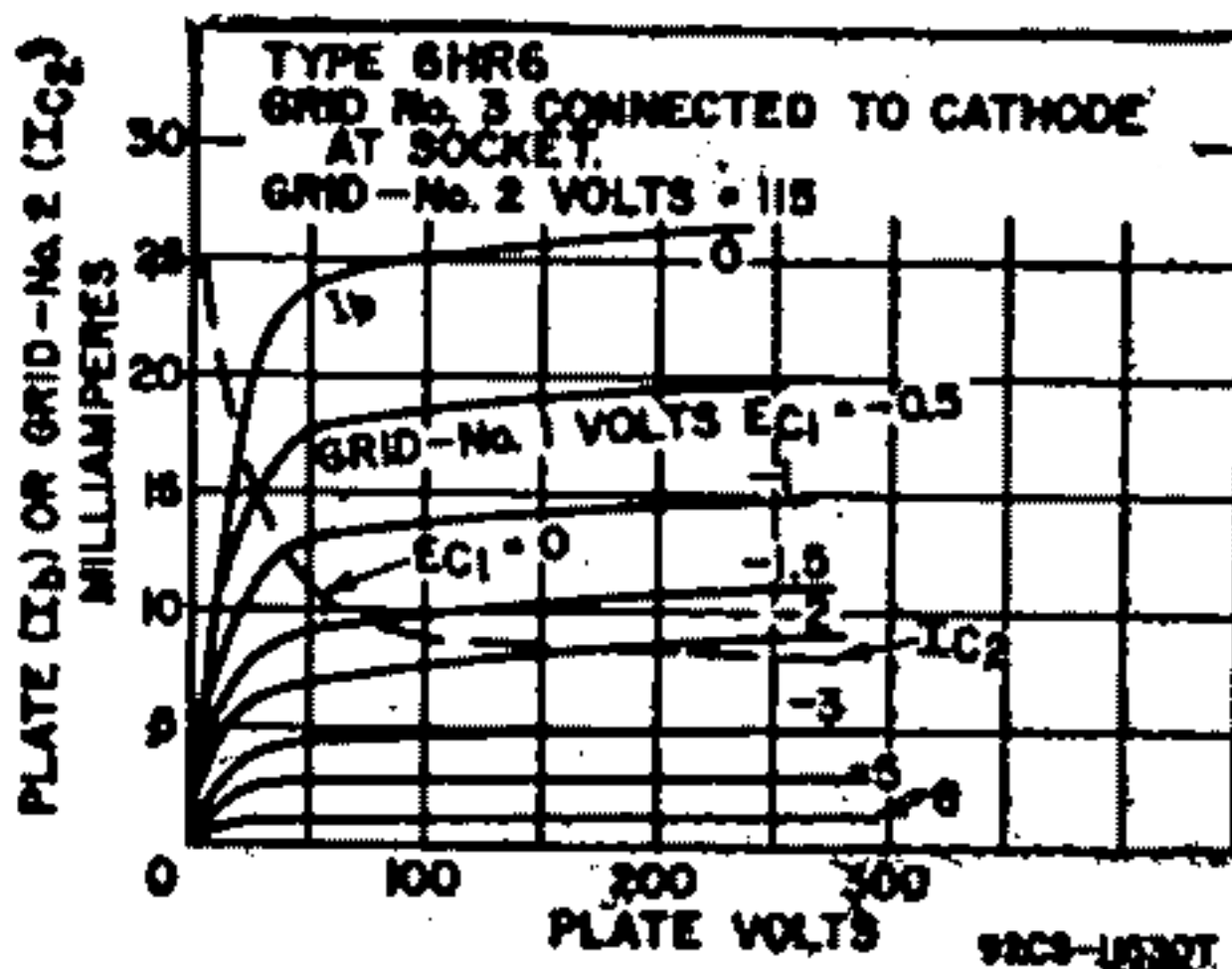
Plate Supply Voltage	300	volts
Grid-No.3 (Suppressor-Grid) Voltage, Positive value	0	volts
Grid-No.2 (Screen-Grid) Supply Voltage	300	volts
Grid-No.2 Voltage	See curve page 96	
Grid-No.1 (Control-Grid) Voltage:		
Negative-bias value	-50	volts
Positive-bias value	0	volts
Plate Dissipation	3	watts
Grid-No.2 Input:		
For grid-No.2 voltages up to 150 volts	1	watt
For grid-No.2 voltages between 150 and 300 volts	See curve page 96	

**CHARACTERISTICS**

Plate Supply Voltage	200	volts
Grid No.3	Connected to cathode at socket	
Grid-No.2 Supply Voltage	115	volts
Grid-No.1 Supply Voltage	0	volts
Cathode-Bias Resistor	68	ohms
Plate Resistance (Approx.)	0.5	megohm
Transconductance	8500	μmhos
Plate Current	13.2	mA
Grid-No.2 Current	4.8	mA
Grid-No.1 Voltage (Approx.) for transconductance of 60 μmhos	-16	volts

**MAXIMUM CIRCUIT VALUES**

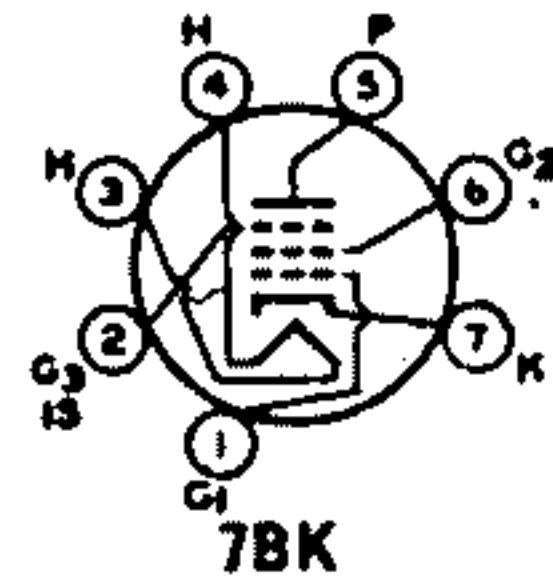
Grid-No.1-Circuit Resistance:		
For fixed-bias operation	0.5	megohm
For cathode-bias operation	1	megohm





**6HS6**  
19HS6

**SHARP-CUTOFF PENTODE**



Miniature type used as if-amplifier and limiter tube in FM receivers. Outlines section, 5C; requires miniature 7-contact socket. Type 19HS6 is identical with type 6HS6 except for heater ratings.

	6HS6	19HS6	
Heater Voltage (ac/dc)	6.3	18.4	volts
Heater Current	0.45	0.15	ampere
Heater Warm-up Time (Average)	11	17	seconds
Heater-Cathode Voltage:			
Peak value	±200 max	±200 max	volts
Average value	100 max	100 max	volts
Direct Interelectrode Capacitances:			
Grid No.1 to Plate		0.006 max	volts
Grid No.1 to Cathode, Heater, Grid No.2, Grid No.3, and Internal Shield		8.8	pF
Plate to Cathode, Heater, Grid No.2, Grid No.3, and Internal Shield		5.2	pF

**Class A<sub>1</sub> Amplifier**

**MAXIMUM RATINGS (Design-Maximum Values)**

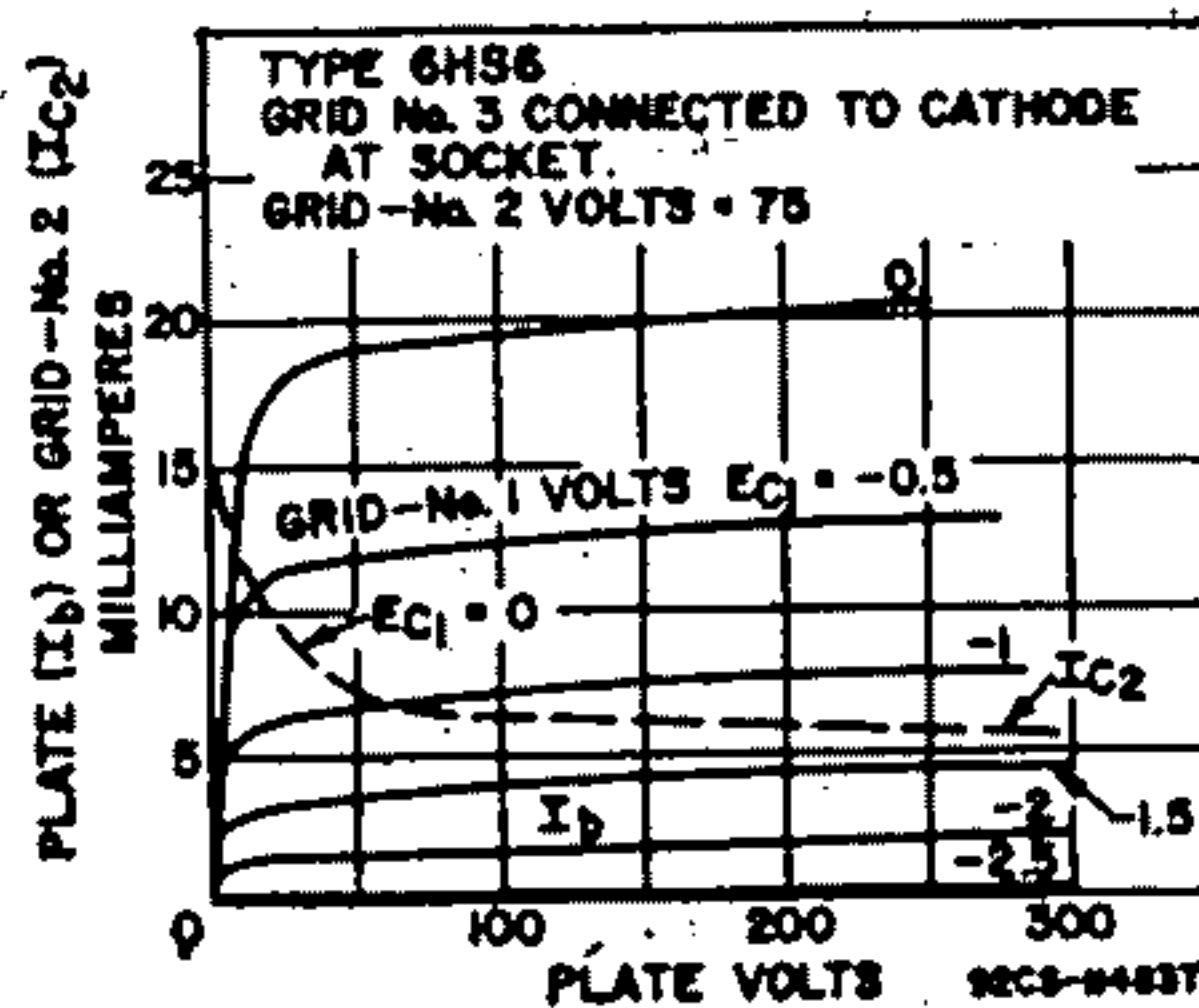
Plate Supply Voltage	300	volts
Grid-No.3 (Suppressor-Grid) Voltage, Positive Value	0	volts
Grid-No.2 (Screen-Grid) Supply Voltage	300	volts
Grid-No.2 Voltage	See curve page 96	
Grid-No.1 (Control-Grid) Voltage:		
Negative-bias value	-50	volts
Positive-bias value	0	volts
Plate Dissipation	8	watts
Grid-No.2 Input:		
For grid-No.2 voltages up to 150 volts	1	watt
For grid-No.2 voltages between 150 and 300 volts	See curve page 96	

**CHARACTERISTICS**

	75	150	
Plate Supply Voltage	75	150	volts
Grid No.3	Connected to cathode at socket		
Grid-No.2 Supply Voltage	75	75	volts
Grid-No.1 Supply Voltage	0	0	volts
Cathode-Bias Resistor	68	68	ohms
Amplification Factor*	50	—	
Plate Resistance (Approx.)	—	0.5	megohm
Transconductance	—	9500	μmhos
Plate Current	—	8.8	mA
Grid-No.2 Current	—	2.8	mA
Grid-No.1 Voltage (Approx.) for plate current of 20 μA	—	-4	volts

**MAXIMUM CIRCUIT VALUES**

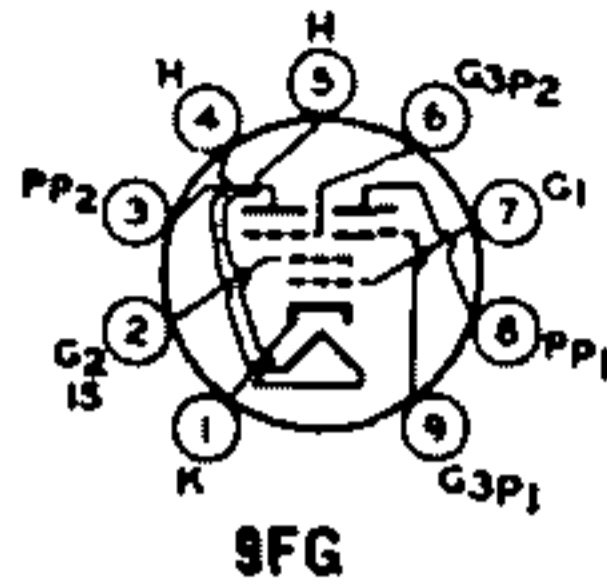
Grid-No.1-Circuit Resistance:		
For fixed-bias operation	0.5	megohm
For cathode-bias operation	1	megohm



**SHARP-CUTOFF  
TWIN PENTODE**

**6HS8**

3HS8, 4HS8



Miniature type used in agc amplifier, sync, and noise-limiting circuits of color and black-and-white television receivers. One pentode unit is used as combined sync separator and sync clipper; second pentode unit is used as agc amplifier. Outlines section, 6E; requires miniature 9-contact socket. Type 3HS8 and 4HS8 are identical with type 6HS8 except for heater ratings.

	3HS8	4HS8	6HS8	
Heater Voltage (ac/dc)	3.15	4.2	6.3	volts
Heater Current	0.6	0.45	0.3	ampere
Heater Warm-up Time (Average)	11	11	—	seconds
Heater-Cathode Voltage:				
Peak value	±200 max	±200 max	±200 max	volts
Average value	100 max	100 max	100 max	volts
Direct Interelectrode Capacitances:				
Grid No.3 to Plate (Each Unit)			2	pF
Grid No.1 to All Other Electrodes			6	pF
Grid No.3 (Each Unit) to All Other Electrodes			3.6	pF
Plate (Each Unit) to All Other Electrodes			3	pF
Grid No.3 (Unit No.1) to Grid No.3 (Unit No.2)			0.015 max	pF

**Class A<sub>1</sub> Amplifier**

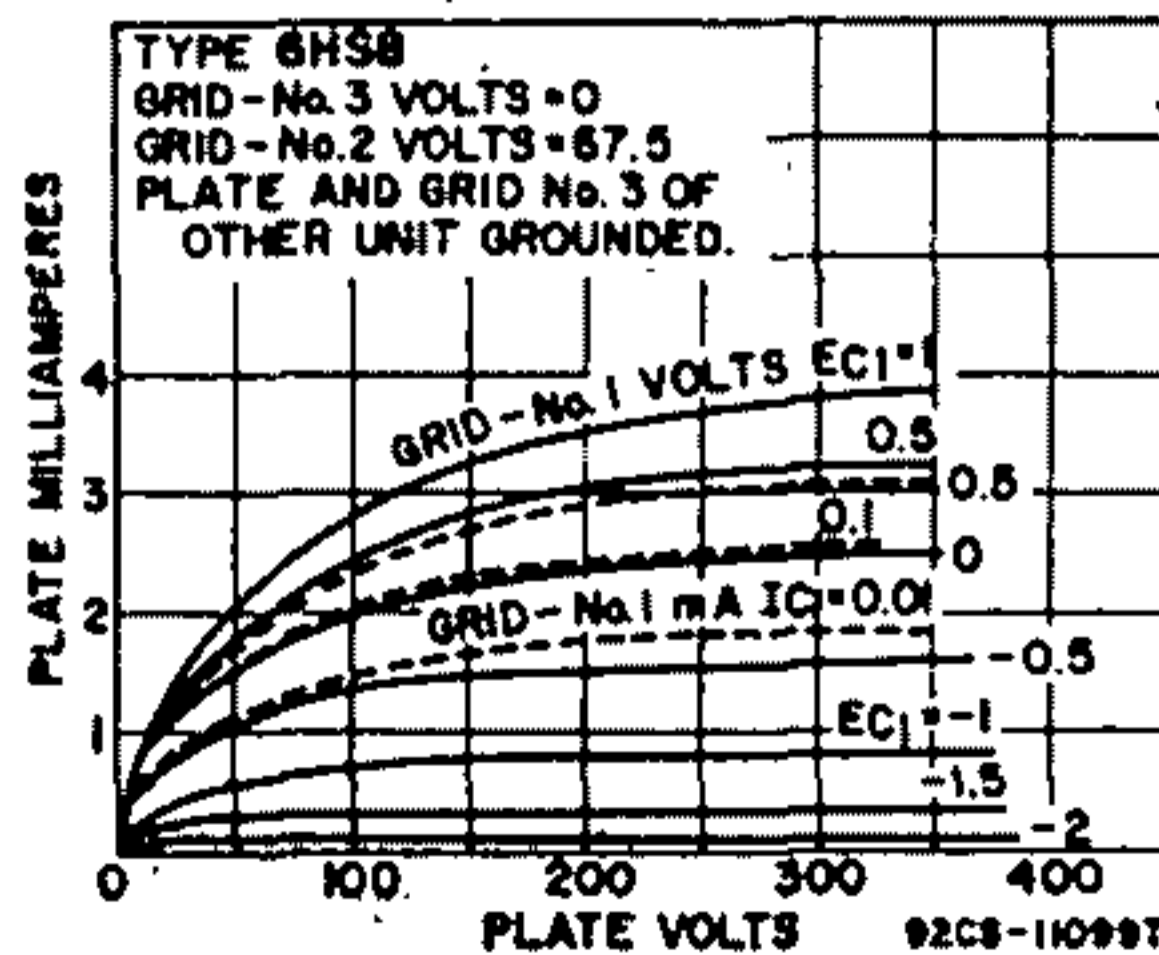
**MAXIMUM RATINGS (Design-Maximum Values)**

Plate Voltage (Each Unit)	300	volts
Grid-No.3 (Suppressor-Grid) Voltage (Each Unit):		
Peak positive value	50	volts
DC negative value	—50	volts
DC positive value	3	volts
Grid-No.2 (Screen-Grid) Voltage	150	volts
Grid-No.1 (Control-Grid) Voltage, Negative-bias value	—50	volts
Cathode Current	12	mA
Plate Dissipation (Each Unit)	1.1	watts
Grid-No.2 Input	0.75	watt

**CHARACTERISTICS**

**With One Unit Operating\***

Plate Voltage	100	100	volts
Grid-No.3 Voltage	0	0	volts
Grid-No.2 Voltage	67.5	67.5	volts
Grid-No.1 Voltage	0	0	volts
Transconductance, Grid No.3 to Plate	—	450	μmhos
Transconductance, Grid No.1 to Plate	1100	—	μmhos
Plate Current	—	2	mA
Grid-No.3 Voltage (Approx.) for plate current of 100 μA	—	—3.5	volts
Grid-No.1 Voltage (Approx.) for plate current of 100 μA	—	—2.3	volts



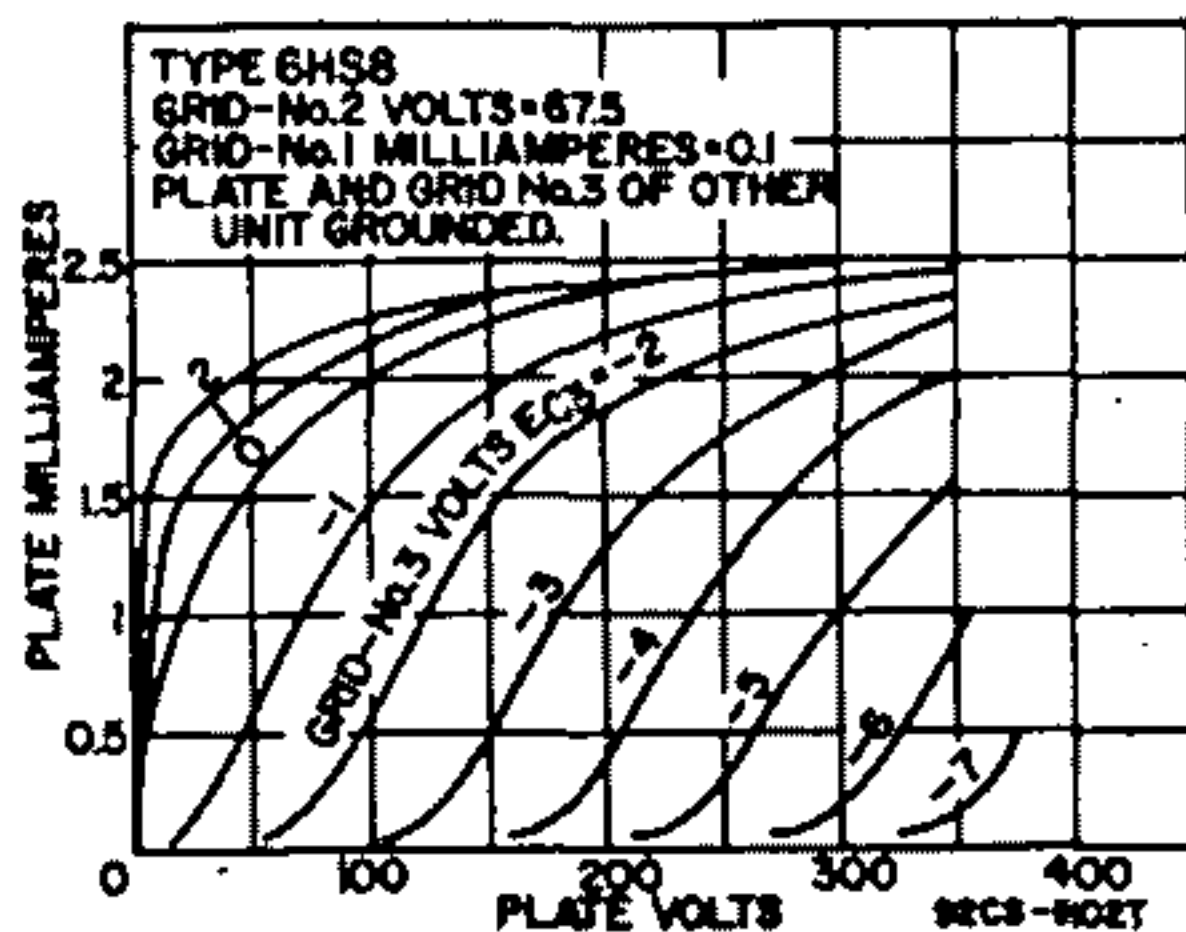
With Both Units Operating

Plate Voltage (Each Unit) .....	100	100	volts
Grid-No.3 Voltage (Each Unit) .....	-10	0	volts
Grid-No.2 Voltage .....	67.5	67.5	volts
Grid-No.1 Voltage .....	"	"	volts
Plate Current (Each Unit) .....	—	2	mA
Grid-No.2 Current .....	7	4.4	mA
Cathode Current .....	7.1	8.5	mA

MAXIMUM CIRCUIT VALUES

Grid-No.3-Circuit Resistance (Each Unit) .....	0.5	megohm
Grid-No.1-Circuit Resistance .....	0.5	megohm

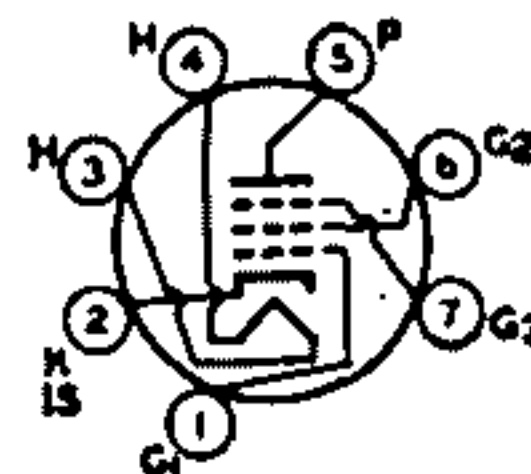
- With plate and grid No.3 of other unit connected to ground.
- Adjusted to give grid-No.1 current of 0.1 milliamperes.



**6HZ6**  
5HZ6

**SHARP-CUTOFF PENTODE**

Miniature type used as sound-detector tube in FM and color and black-and-white television receivers. Tube has two independent control grids. Outlines section, 5C; requires miniature 7-contact socket. Type 5HZ6 is identical with type 6HZ6 except for heater ratings.



7EN

Heater Voltage (ac/dc) .....	5HZ6	6HZ6	
Heater Current .....	4.75	6.3	volts
Heater Warm-up Time (Average) .....	0.6	0.45	ampere
Heater-Cathode Voltage:			seconds
Peak value .....	±200 max	±200 max	volts
Average value .....	100 max	100 max	volts
Direct Interelectrode Capacitances (Approx.):			
Grid No.1 to Plate .....		0.023	pF
Grid No.1 to Cathode, Heater, Grid No.2, Grid No.3, and Internal Shield .....		8.2	pF
Grid No.1 to Grid No.3 .....		0.09	pF
Grid No.3 to Plate .....		1.6	pF
Grid No.3 to Cathode, Heater, Grid No.1, Grid No.2, Plate, and Internal Shield .....		7.2	pF

**Class A<sub>1</sub> Amplifier**

CHARACTERISTICS

Plate Supply Voltage .....	150	volts
Grid-No.3 Supply Voltage .....	0	volts
Grid-No.2 Supply Voltage .....	100	volts
Grid-No.1 Supply Voltage .....	0	volts
Cathode-Bias Resistor .....	180	ohms
Plate Resistance (Approx.) .....	0.11	megohm
Transconductance, Grid No.1 to Plate .....	3400	μmhos
Transconductance, Grid No.3 to Plate .....	600	μmhos
Plate Current .....	2.2	mA
Grid-No.2 Current .....	2.2	mA
Grid-No.3 Supply Voltage (Approx.) for plate current of 20 μA ..	-7	volts
Grid-No.1 Supply Voltage (Approx.) for plate current of 20 μA ..	-4.5	volts



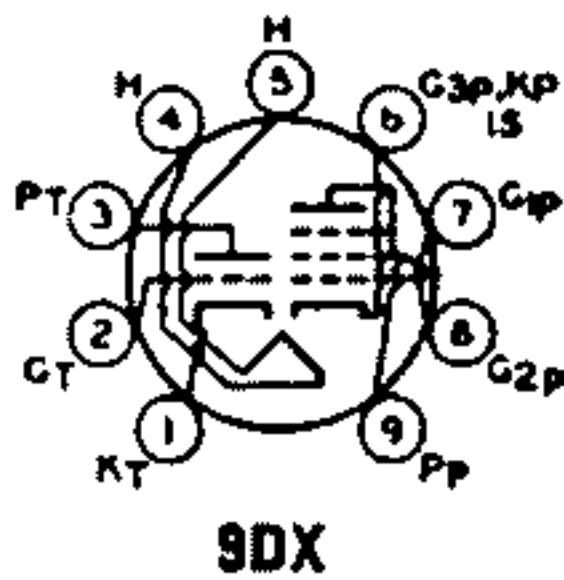
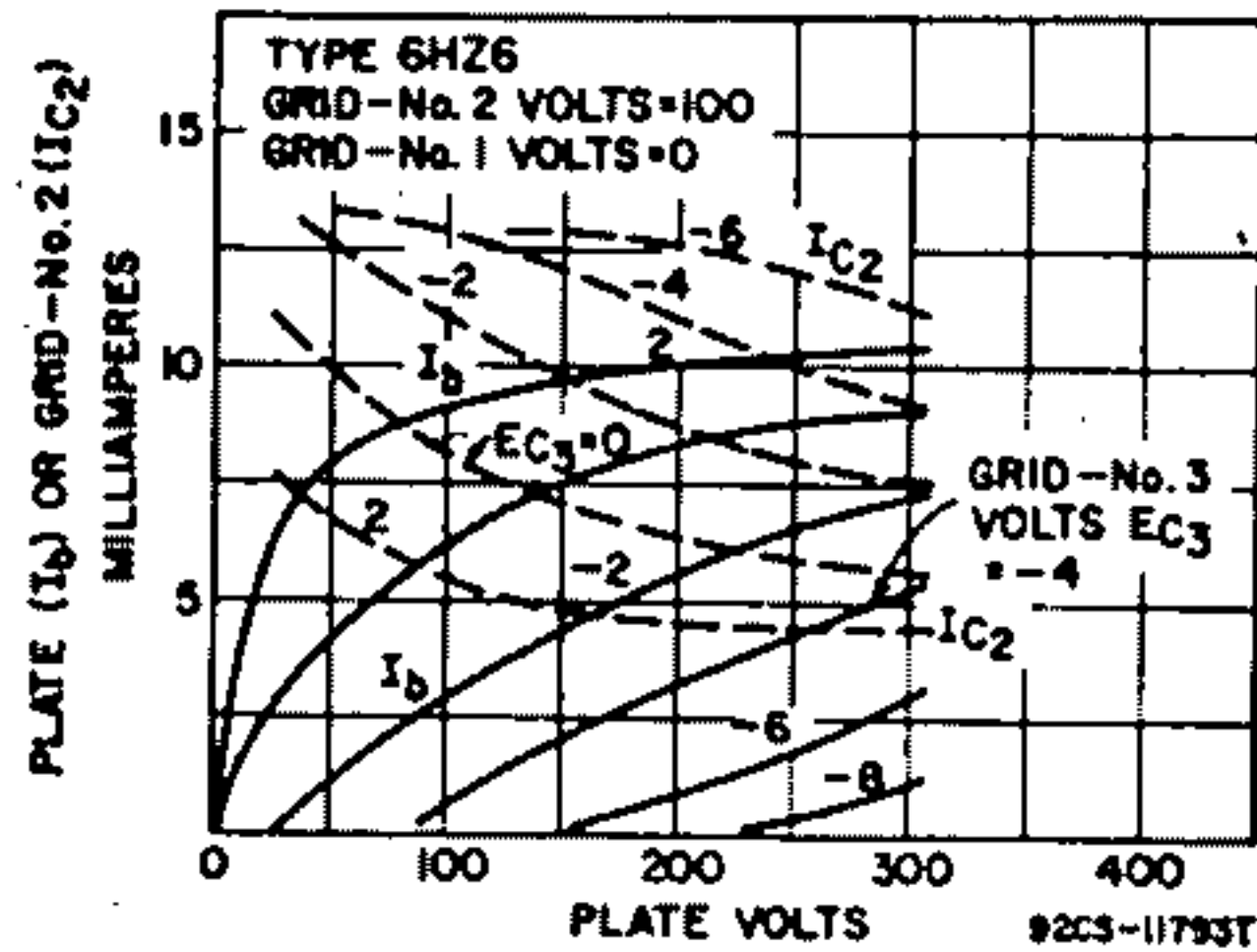
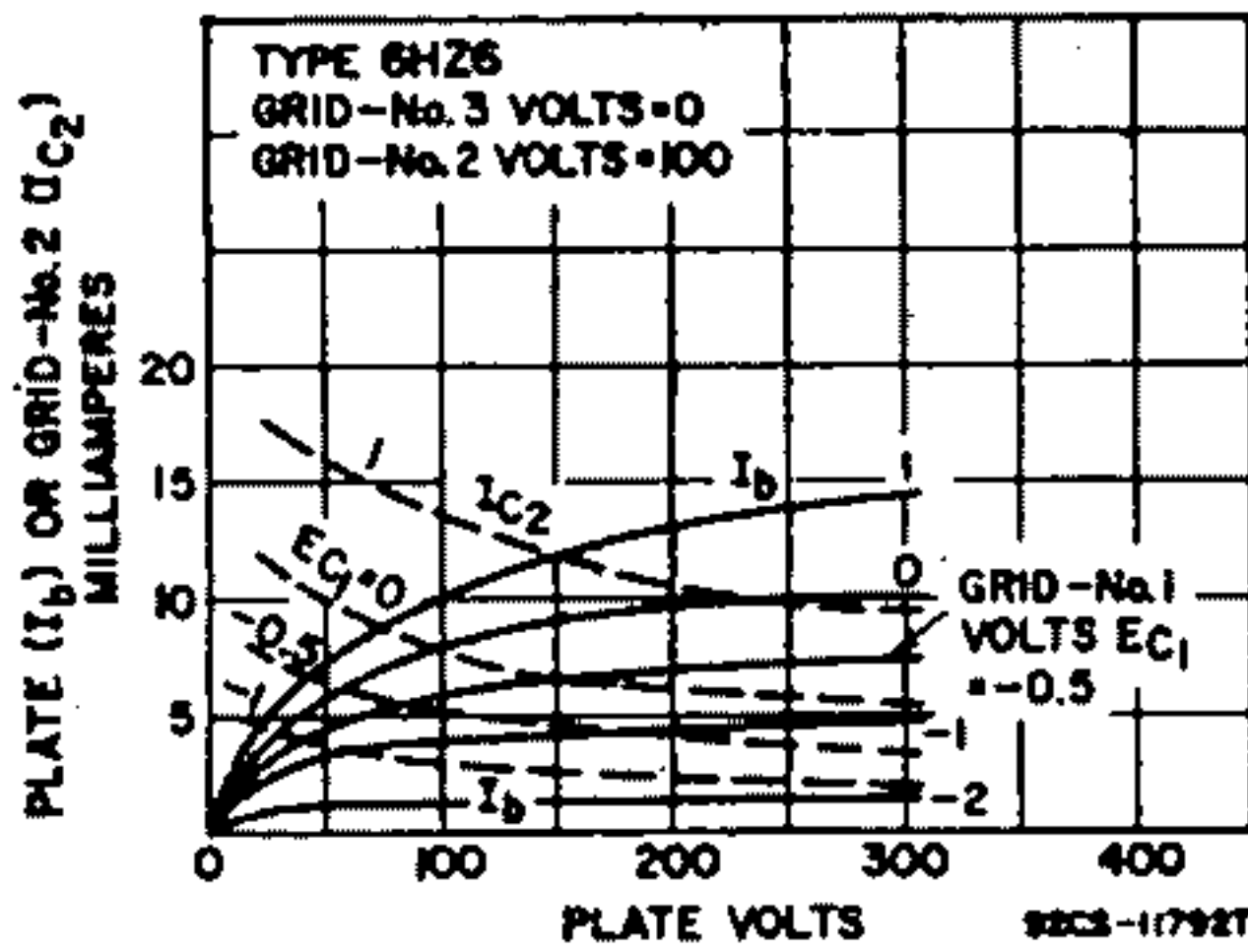
FM Sound Detector

MAXIMUM RATINGS (Design-Maximum Values)

Plate Voltage	300	volts
Grid-No.3 (Control-Grid) Voltage:		
Negative value (dc and peak ac)	-100	volts
Positive value (dc and peak ac)	25	volts
Grid-No.2 (Screen-Grid) Supply Voltage	300	volts
Grid-No.2 Voltage	See curve page 96	
Grid-No.1 (Control-Grid) Voltage:		
Negative-bias value	-50	volts
Positive-bias value	0	volts
Plate Dissipation	1.7	watts
Grid-No.3 Input	0.1	watt
Grid-No.2 Input:		
For grid-No.2 voltages up to 150 volts	1	watt
For grid-No.2 voltages between 150 and 300 volts	See curve page 96	

MAXIMUM CIRCUIT VALUES

Grid-No.3-Circuit Resistance	0.68	megohm
Grid-No.1-Circuit Resistance:		
For fixed-bias operation	0.22	megohm
For cathode-bias operation	0.47	megohm



9DX

HIGH-MU TRIODE—  
SHARP-CUTOFF PENTODE

6HZ8

Miniature type used in television receiver applications. The triode unit is used as a voltage amplifier or sync separator, and the pentode unit as a video amplifier. Outlines section, 8E; requires miniature 9-contact socket. Heater: volts (ac/dc), 6.3; amperes, 1.125; maximum heater-cathode volts, ±200 peak, 100 average.

Class A<sub>1</sub> Amplifier

MAXIMUM RATINGS (Design-Maximum Values)

Plate Voltage	300	volts
Grid-No.2 (Screen-Grid) Supply Voltage	380	volts
Grid-No.2 Voltage	See curve page 96	
Grid-No.1 (Control-Grid) Voltage, Positive bias value	0	volts
Plate Dissipation	1	watts
Grid-No.2 Input:		
For grid-No.2 voltages up to 165 volts	2	watts
For grid-No.2 voltages between 165 and 380 volts	See curve page 96	

	Triode Unit	Pentode Unit	
Plate Voltage	300	300	volts
Grid-No.2 (Screen-Grid) Supply Voltage	—	380	volts
Grid-No.2 Voltage	See curve page 96		
Grid-No.1 (Control-Grid) Voltage, Positive bias value	0	0	volts
Plate Dissipation	1	8	watts
Grid-No.2 Input:			
For grid-No.2 voltages up to 165 volts	—	2	watts
For grid-No.2 voltages between 165 and 380 volts	See curve page 96		

CHARACTERISTICS

Plate Voltage	200	60	250	volts
Grid-No.2 Supply Voltage	—	170	170	volts
Grid-No.1 Voltage	-3	0	—	volts
Cathode-Bias Resistor	—	—	100	ohms
Amplification Factor	70	—	—	
Plate Resistance (Approx.)	—	—	0.14	megohm
Transconductance	4000	—	12800	μmhos
Plate Current	3.5	90*	29	mA
Grid-No.2 Current	—	22.5*	6	mA
Grid-No.1 Voltage (Approx.) for plate current of 10 μA	-5	—	-11.5	volts

**MAXIMUM CIRCUIT VALUES**

Grid-No.1-Circuit Resistance:			
For fixed-bias operation .....	0.5	0.25	megohm
For cathode-bias operation .....	1	1	megohm

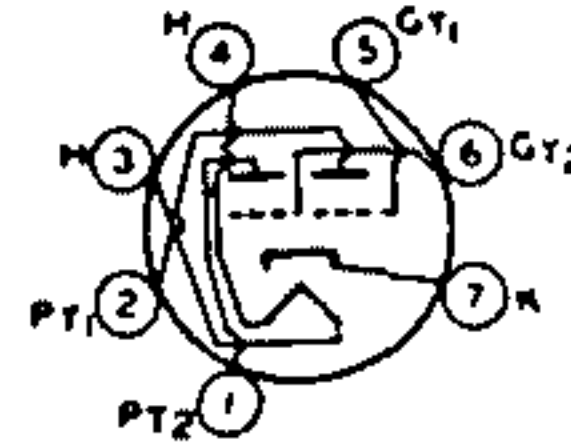
\* This value can be measured by a method involving a recurrent waveform such that the maximum ratings of the tube will not be exceeded.

- 6J5** Refer to chart at end of section.
- 6J5GT**
- 6J6** Refer to chart at end of section.

**6J6A MEDIUM-MU TWIN TRIODE**

5J6

Miniature type used as combined rf power amplifier and oscillator or as twin af amplifier. With push-pull arrangement of the grids and the plates in parallel, this type can also be used as a mixer at frequencies as high as 600 MHz. Outlines section, 5C; requires miniature 7-contact socket. Type 5J6 is identical with type 6J6A except for heater ratings.



7BF

	<b>5J6</b>	<b>6J6A</b>	
Heater Voltage (ac/dc) .....	4.7	6.3	volts
Heater Current .....	0.6	0.45	ampere
Heater Warm-up Time (Average) .....	11	11	seconds
Peak Heater-Cathode Voltage .....	±100 max	±100 max	volts
Direct Interelectrode Capacitances (Each Unit, Approx.):	Unshielded	Shielded	
Grid to Plate .....	1.6	1.6	pF
Grid to Cathode and Heater .....	2.2	2.6	pF
Plate to Cathode and Heater (Unit No.1) .....	0.4	1.6	pF
Plate to Cathode and Heater (Unit No.2) .....	0.4	1	pF

**Class A<sub>1</sub> Amplifier**

<b>MAXIMUM RATINGS (Design-Maximum Values)</b>		
Plate Voltage .....	300	volts
Grid Voltage, Positive-bias value .....	0	volts
Plate Dissipation .....	1.5	watts
<b>CHARACTERISTICS</b>		
Plate Voltage .....	100	volts
Cathode-Bias Resistor .....	50†	ohms
Amplification Factor .....	38	
Plate Resistance (Approx.) .....	7100	ohms
Transconductance .....	5300	μmhos
Plate Current .....	8.5	mA

**MAXIMUM CIRCUIT VALUES**

Grid-Circuit Resistance:		
For fixed-bias operation .....	Not recommended	
For cathode-bias operation .....	0.5	megohm

† Value is for both units operating at the specified conditions.

**RF Power Amplifier and Oscillator—Class C Telegraphy**

Key-down conditions per tube without modulation

<b>MAXIMUM RATINGS (Design-Center Values, Each Unit)</b>		
Plate Voltage .....	300	volts
Grid Voltage:		
Negative-bias value .....	-40	volts
Positive-bias value .....	0	volts
Plate Current .....	15	mA
Grid Current .....	8	mA
Plate Input .....	4.5	watts
Plate Dissipation .....	1.5	watts
<b>TYPICAL PUSH-PULL OPERATION (Both Units)</b>		
Plate Voltage .....	150	volts
Grid Voltage* .....	-10	volts
Plate Current .....	30	mA
Grid Current (Approx.) .....	16	mA
Driving Power (Approx.) .....	0.35	watt
Power Output (Approx.) .....	3.5	watts

\* Obtained by grid resistor (625 ohms), cathode-bias resistor (220 ohms), or fixed supply.

Refer to chart at end of section.

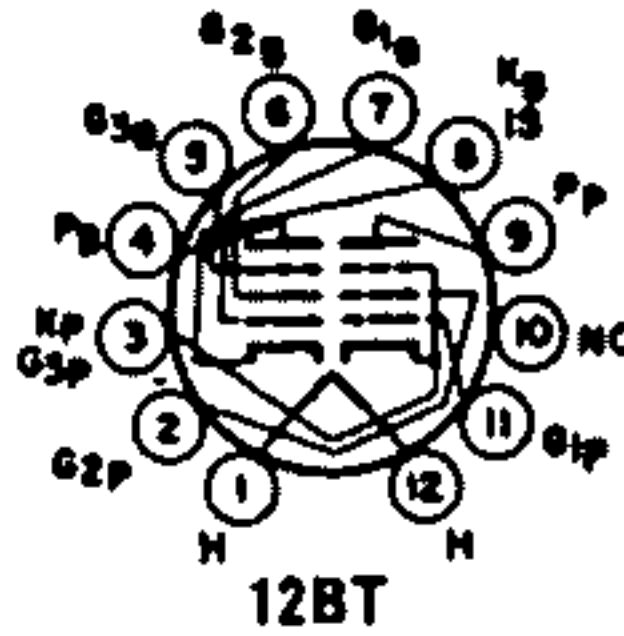
**6J7**  
**6J7G**  
**6J7GT**

Refer to chart at end of section.

**6J8G**

**PENTODE—  
BEAM POWER TUBE**

**6J10**  
13J10



Duodecar type used in FM and color and black-and-white television receivers. The pentode unit is used as a gated-beam discriminator and the beam power unit is used in audio power-output stages in FM and television limiter and discriminator applications. Outlines section, 8B; requires duodecar 12-contact socket. Type 13J10 is identical with type 6J10 except for heater ratings.

	6J10	13J10	
Heater Voltage (ac/dc)	6.3	18.2	volts
Heater Current	0.95	0.45	ampere
Heater Warm-up Time (Average)	—	11	seconds
Heater-Cathode Voltage:			
Peak value	±200 max	±200 max	volts
Average value	100 max	100 max	volts

**Pentode Unit as Class A<sub>1</sub> Amplifier**

**MAXIMUM RATINGS (Design-Maximum Values)**

Plate Voltage	275	volts
Grid-No.2 (Screen-Grid) Voltage	275	volts
Plate Dissipation	10	watts
Grid-No.2 Input	2	watts

**CHARACTERISTICS AND TYPICAL OPERATION**

Plate Voltage	250	volts
Grid-No.2 Voltage	250	volts
Grid-No.1 Voltage	-8	volts
Peak AF Grid-No.1 Voltage	8	volts
Plate Resistance (Approx.)	0.1	megohm
Transconductance	6500	μmhoe
Zero-Signal Plate Current	35	mA
Maximum-Signal Plate Current	39	mA
Zero-Signal Grid-No.2 Current	2.5	mA
Maximum-Signal Grid-No.2 Current	7	mA
Load Resistance	5000	ohms
Total Harmonic Distortion (Approx.)	10	per cent
Maximum-Signal Power Output	4.2	watts

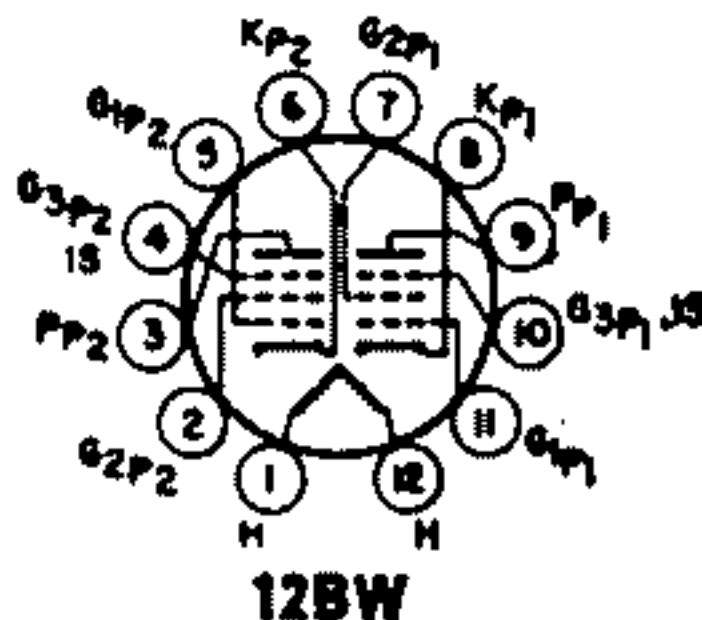
**MAXIMUM CIRCUIT VALUES**

Grid-No.1-Circuit Resistance:		
For fixed-bias operation	0.25	megohm
For cathode-bias operation	0.5	megohm

**Beam Power Unit as Gated-Beam Discriminator**

**MAXIMUM RATINGS (Design-Maximum Values)**

Plate Supply Voltage	330	volts
Grid-No.2 (Accelerator-Grid) Voltage	110	volts
Peak Positive Grid-No.1 Voltage	60	volts
Average Cathode Current	18	mA



**SHARP-CUTOFF  
TWIN PENTODE**

**6J11**

Duodecar type used as if-amplifier tube in television receivers. Outlines section, 8A; requires duodecar 12-contact socket.



Heater Voltage (ac/dc) .....	6.3	volts
Heater Current .....	0.8	ampere
Heater-Cathode Voltage:		
Peak value .....	±200 max	volts
Average value .....	100 max	volts
Direct Interelectrode Capacitances:**		
Unit No. 1:		
Grid No.1 to Cathode, Heater, Grid No.2, Grid No.3, Grid No.3 of Unit No.2, and Internal Shield .....	11	pF
Plate to Cathode, Heater, Grid No.2, Grid No.3, Grid No.3 of Unit No.2, and Internal Shield .....	2.8	pF
Unit No. 2:		
Grid No.1 to Cathode, Heater, Grid No.2, Grid No.3, Grid No.3 of Unit No.1, and Internal Shield .....	11	pF
Plate to Cathode, Heater, Grid No.2, Grid No.3, Grid No.3 of Unit No.1, and Internal Shield .....	3.2	pF
Grid No.1 to Plate (Each Unit) .....	0.04 max	pF
Cathode of Unit No.1 to Cathode of Unit No.2 .....	0.02 max	pF
Grid No.1 of Unit No.1 to Plate of Unit No.2 .....	0.008 max	pF
Grid No.1 of Unit No.2 to Plate of Unit No.1 .....	0.008 max	pF
Plate of Unit No.1 to Plate of Unit No.2 .....	0.03 max	pF

\*\* With external shield connected to cathode.

**Class A<sub>1</sub> Amplifier (Each Unit)**

**MAXIMUM RATINGS (Design-Maximum Values)**

Plate Voltage .....	330	volts
Grid-No.2 (Screen-Grid) Supply Voltage .....	330	volts
Grid-No.2 Voltage .....	See curve page 96	
Grid-No.1 (Control-Grid) Voltage, Positive-bias value .....	0	volts
Plate Dissipation .....	3.1	watts
Grid-No.2 Input:		
For grid No.2 voltages up to 165 volts .....	0.65	watt
For grid No.2 voltages between 165 and 300 volts .....	See curve page 96	

**CHARACTERISTICS**

Plate Supply Voltage .....	125	volts
Grid No.3 (Suppressor Grid) .....	Connected to cathode at socket	
Grid-No.2 Voltage .....	125	volts
Cathode-Bias Resistor .....	56	ohms
Plate Resistance (Approx.) .....	0.2	megohm
Transconductance .....	13000	μmhos
Plate Current .....	11	mA
Grid-No.2 Current .....	3.8	mA
Grid-No.1 Voltage (Approx.) for plate current of 20 μA .....	-3	volts

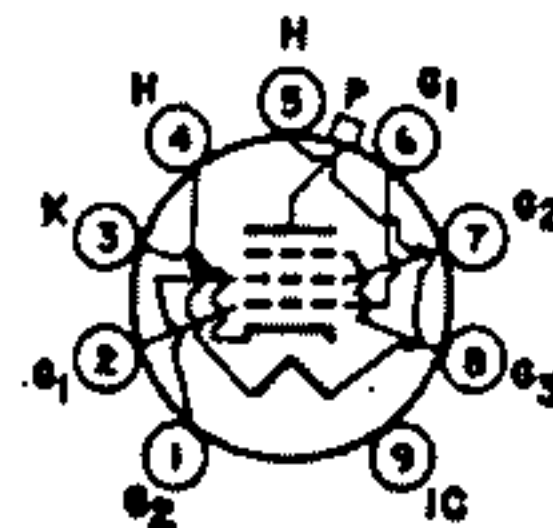
**MAXIMUM CIRCUIT VALUE**

Grid-No.1-Circuit Resistance, for cathode-bias operation .....	0.25	megohm
--	------	--------

**6JB6  
6JB6A BEAM POWER TUBE**

12JB6, 12JB6A,  
17JB6, 17JB6A

Novar types used as high-efficiency horizontal-deflection amplifiers in television receivers. Outlines section, 18A and 32, respectively; require novar 9-contact socket. Types 12JB6 and 12JB6A and types 17JB6 and 17JB6A are identical with types 6JB6 and 6JB6A except for heater ratings.



9QL

	6JB6 6JB6A	12JB6 12JB6A	17JB6 17JB6A	
Heater Voltage (ac/dc) .....	6.3	12.6	16.8	volts
Heater Current .....	1.2	0.6	0.45	amperes
Heater Warm-up Time (Average) .....	—	11	11	seconds
Heater-Cathode Voltage:				
Peak value .....	±200 max	±200 max	±200 max	volts
Average value .....	100 max	100 max	100 max	volts
Direct Interelectrode Capacitances (Approx.):				
Grid No.1 to Plate .....			0.2	pF
Grid No.1 to Cathode, Heater, Grid No.2, and Grid No.3 .....			15	pF
Plate to Cathode, Heater, Grid No.2, and Grid No.3 .....			6	pF

**Class A<sub>1</sub> Amplifier**

**CHARACTERISTICS**

	Triode Connection <sup>a</sup>	Pentode Connection	
Plate Voltage	150	60 150	volts
Grid No.3 (Suppressor Grid)	—	Connected to cathode at socket	volts
Grid No.2 (Screen-Grid) Voltage	—	150 150	volts
Grid No.1 (Control-Grid) Voltage	-22.5	0 -22.5	volts
Mu-Factor, Grid No.2 to Grid No.1	4.4	—	
Plate Resistance (Approx.)	—	15000	ohms
Transconductance	—	7100	μmhos
Plate Current	—	390 <sup>b</sup> 70	mA
Grid-No.2 Current	—	32 <sup>b</sup> 2.1	mA
Grid-No.1 Voltage for plate current of 1 mA	—	— -42	volts

<sup>a</sup> Grid No.2 connected to plate.

<sup>b</sup> This value can be measured by a method involving a recurrent waveform such that the maximum ratings of the tube will not be exceeded.

**Horizontal-Deflection Amplifier**

For operation in a 525-line, 30-frame system

**MAXIMUM RATINGS (Design-Maximum Values)**

DC Plate Supply Voltage	770	volts
Peak Positive-Pulse Plate Voltage <sup>‡</sup>	6500	volts
Peak Negative-Pulse Plate Voltage	-1500	volts
DC Grid-No.3 Voltage <sup>†</sup>	70	volts
DC Grid-No.2 Voltage	220	volts
DC Grid-No.1 Voltage	-55	volts
Peak Negative-Pulse Grid-No.1 Voltage	-330	volts
Peak Cathode Current	560	mA
Average Cathode Current	175	mA
Plate Dissipation <sup>*</sup>	17.5	watts
Grid-No.2 Input	8.5	watts
Bulb Temperature (At hottest point)	240	°C

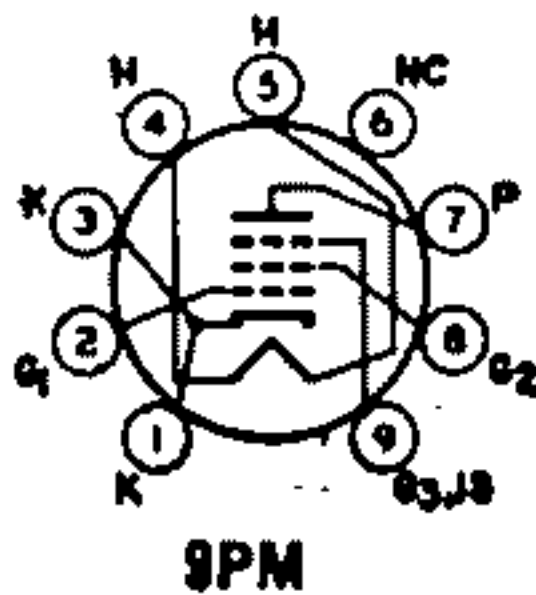
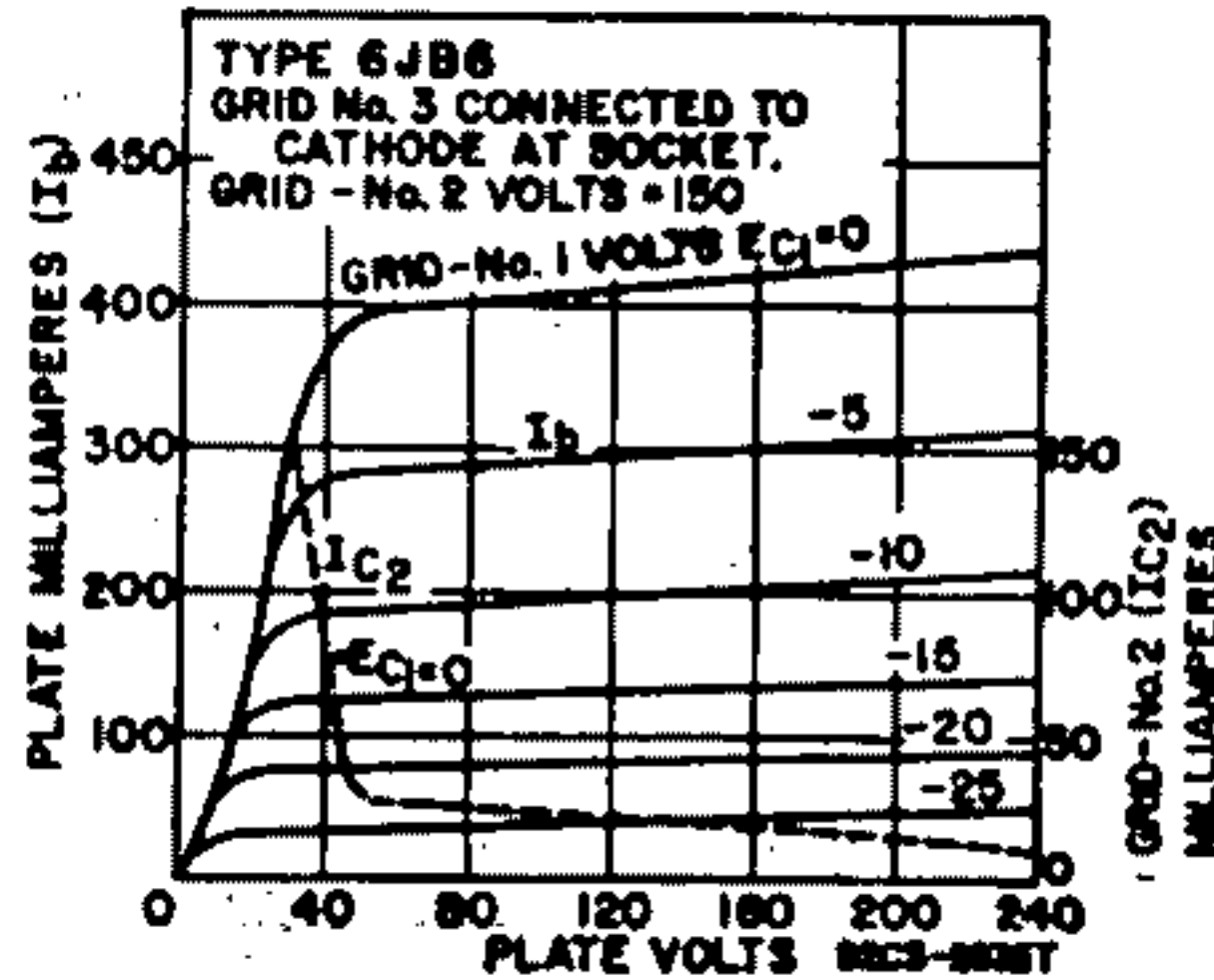
**MAXIMUM CIRCUIT VALUE**

Grid-No.1-Circuit Resistance, for grid-resistor-bias operation .... 1 megohm

<sup>‡</sup> Pulse duration must not exceed 15% of a horizontal scanning cycle (10 microseconds).

<sup>†</sup> For horizontal-deflection service, a positive voltage may be applied to grid No.3 to minimize "snivets" interference in both vhf and uhf television receivers. A typical value is 30 volts.

<sup>\*</sup> A bias resistor or other means is required to protect the tube in absence of excitation.



**SHARP-CUTOFF PENTODE**

**6JC6  
6JC6A**

3JC6, 3JC6A  
4JC6, 4JC6A

Miniature type with frame grid used in if-amplifier stages of color and black-and-white television receivers utilizing intermediate frequencies in the order of 40 MHz. Outlines section, 6B; requires miniature 9-contact socket. Types 3JC6 and 4JC6 are identical with type 6JC6 except for heater ratings. Types 3JC6A and 4JC6A are identical with type 6JC6A except for heater ratings.

	2JC6 3JC6A	4JC6 4JC6A	6JC6 6JC6A	
Heater Voltage (ac/dc) .....	8.5	4.5	6.3	volts
Heater Current .....	0.6	0.45	0.3	ampere
Heater Warm-up Time (Average) .....	11	11	—	seconds
Heater-Cathode Voltage:				
Peak value .....	±200 max	±200 max	±200 max	volts
Average value .....	100 max	100 max	100 max	volts
Direct Interelectrode Capacitances:	6JC6	6JC6A		
Grid No.1 to Plate .....	0.019 max	0.019 max		pF
Grid No.1 to Cathode, Heater, Grid No.2, Grid No.3, and Internal Shield .....	8.2	8.5		pF
Plate to Cathode, Heater, Grid No.2, Grid No.3, and Internal Shield .....	8	8		pF

**Class A<sub>1</sub> Amplifier**

**MAXIMUM RATINGS (Design-Maximum Values)**

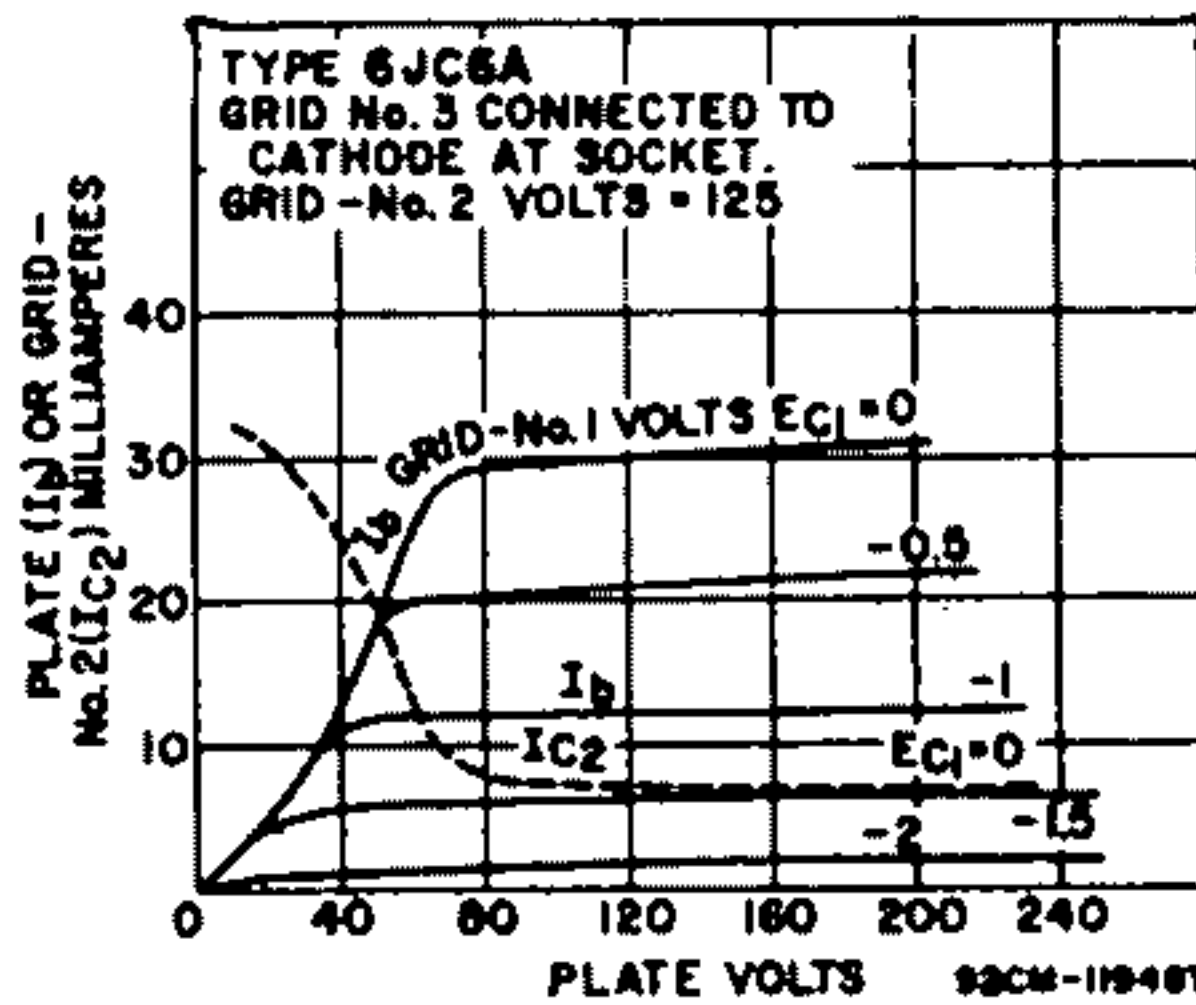
	2JC6 3JC6A	4JC6 4JC6A	6JC6 6JC6A	
Plate Voltage .....	330	330		volts
Grid-No.3 (Suppressor-Grid) Voltage, Positive value .....	0	0		volts
Grid-No.2 (Screen-Grid) Supply Voltage .....	330	330		volts
Grid-No.2 Voltage .....				See curve page 96
Grid-No.1 (Control-Grid) Voltage, Positive-bias value .....	0	0		volts
Plate Dissipation .....	2.5	3.1		watts
Grid-No.2 Input:				
For grid-No.2 voltages up to 165 volts .....	0.6	0.7		watt
For grid-No.2 voltages between 165 and 330 volts .....				See curve page 96

**CHARACTERISTICS**

	2JC6 3JC6A	4JC6 4JC6A	6JC6 6JC6A	
Plate Supply Voltage .....	125	125		volts
Grid No.3 .....				Connected to cathode at socket
Grid-No.2 Supply Voltage .....	125	125		volts
Cathode-Bias Resistor .....	56	56		ohms
Plate Resistance (Approx.) .....	0.18	0.18		megohm
Transconductance .....	15000	16000		μmhos
Plate Current .....	18	14		mA
Grid-No.2 Current .....	3.2	3.4		mA
Grid-No.1 Voltage (Approx.) for plate current of 100 μA .....	-3	-3		volts

**MAXIMUM CIRCUIT VALUES**

	2JC6 3JC6A	4JC6 4JC6A	6JC6 6JC6A	
Grid-No.1-Circuit Resistance:				
For fixed-bias operation .....	0.25	0.25		megohm
For cathode-bias operation .....	1	1		megohm



**6JC8**

**MEDIUM-MU TRIODE—SHARP-CUTOFF PENTODE**

Miniature type used as combined vhf oscillator and mixer tube in television receivers. Outlines section, 6B; requires miniature 9-contact socket. Heater: volts (ac/dc), 6.3; amperes, 0.45; warm-up time (average), 11 seconds; maximum heater-cathode volts ±200 peak, 100 average.





**Class A<sub>1</sub> Amplifier**

**MAXIMUM RATINGS (Design-Maximum Values)**

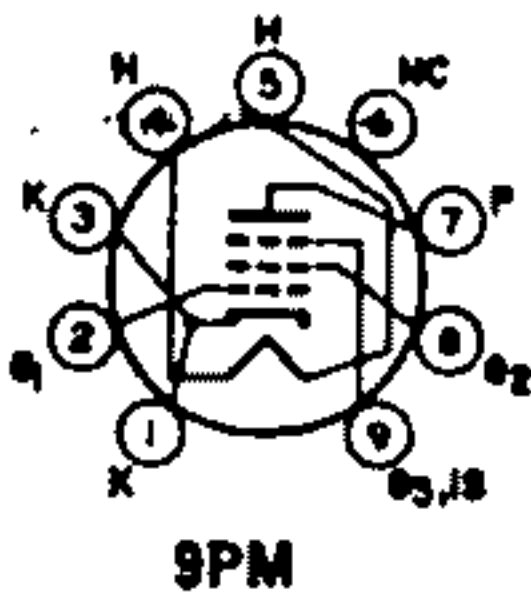
	Triode Unit	Pentode Unit	
Plate Voltage	275	275	volts
Grid-No.2 (Screen-Grid) Supply Voltage	—	275	volts
Grid-No.2 Voltage	—	See curve page 96	
Grid-No.1 (Control-Grid) Voltage, Positive-bias value	0	0	volts
Plate Dissipation	1.7	2.3	watts
Grid-No.2 Input:			
For grid-No.2 voltages up to 137.5 volts	—	0.45	watt
For grid-No.2 voltages between 137.5 and 275 volts	—	See curve page 96	

**CHARACTERISTICS**

	Triode Unit	Pentode Unit	
Plate Voltage	125	100	125
Grid-No.2 Voltage	—	70	125
Grid-No.1 Voltage	—1	0	—1
Amplification Factor	40	—	—
Plate Resistance (Approx.)	6000	—	300000
Transconductance	6000	6700	5500
Plate Current	12	—	9
Grid-No.2 Current	—	—	2.2
Grid-No.1 Voltage (Approx.) for plate current of 20 $\mu$ A	—7	—	6.5

**MAXIMUM CIRCUIT VALUES**

Grid-No.1-Circuit Resistance:			
For fixed-bias operation	—	0.1	megohm
For cathode-bias operation	—	0.5	megohm



**SHARP-CUTOFF PENTODE**

**6JD6**

3JD6, 4JD6

Miniature type used as if-amplifier tube in color and black-and-white television receivers utilizing an intermediate frequency in the order of 40 MHz. Outlines section, 6B; requires miniature 9-contact socket. Types 3JD6 and 4JD6 are identical with type 6JD6 except for heater ratings.

	3JD6	4JD6	6JD6	
Heater Voltage (ac/dc)	3.5	4.5	6.3	volts
Heater Current	0.6	0.45	0.3	ampere
Heater Warm-up Time (Average)	11	11	—	seconds
Heater-Cathode Voltage:				
Peak value	±200 max	±200 max	±200 max	volts
Average value	100 max	100 max	100 max	volts
Direct Interelectrode Capacitances:				
Grid No.1 to Plate			0.019 max	pF
Grid No.1 to Cathode, Heater, Grid No.2, Grid No.3, and Internal Shield			8.2	pF
Plate to Cathode, Heater, Grid No.2, Grid No.3, and Internal Shield			8	pF

**Class A<sub>1</sub> Amplifier**

**MAXIMUM RATINGS (Design-Maximum Values)**

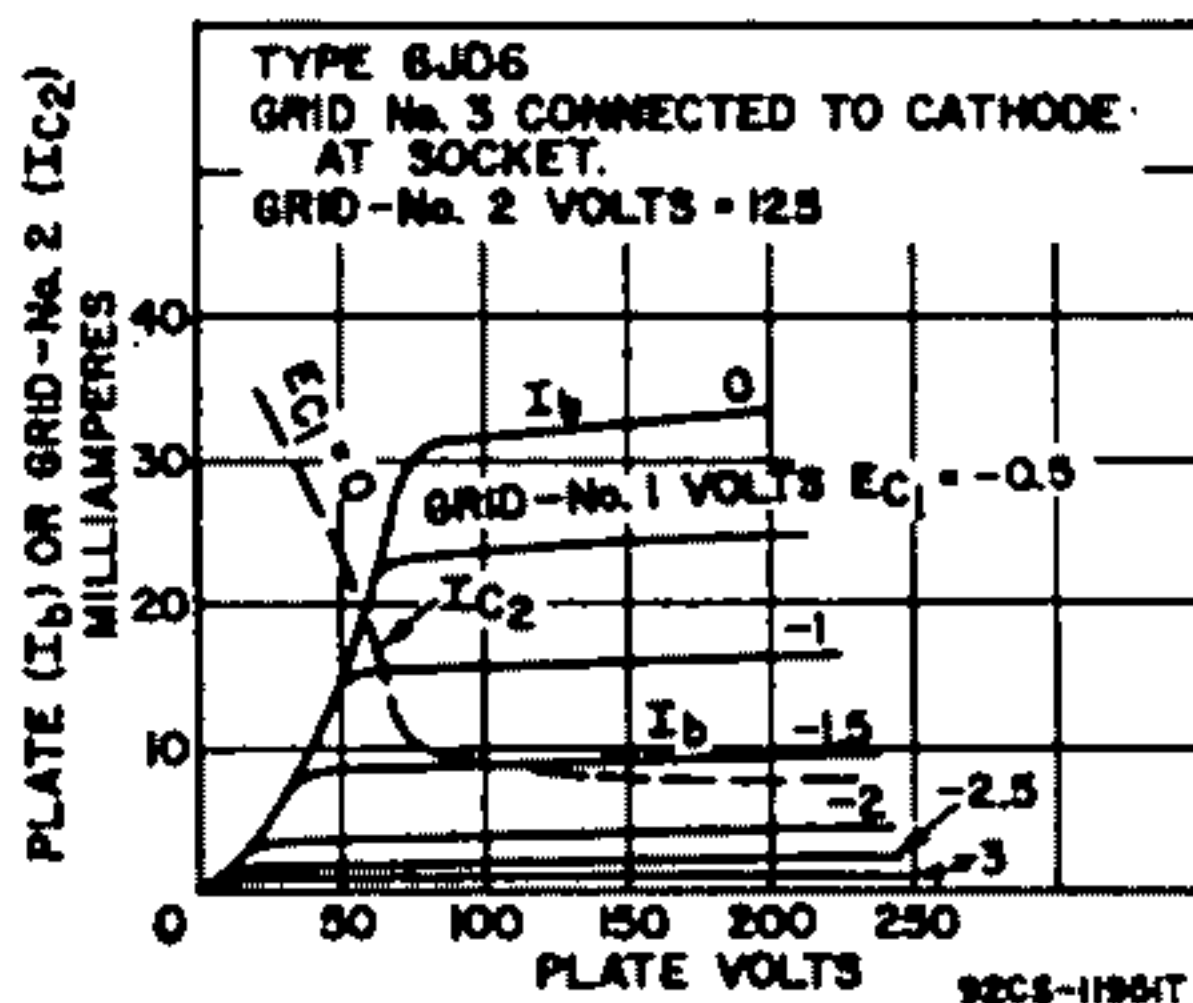
Plate Voltage	330	volts
Grid-No.3 (Suppressor-Grid) Voltage, Positive value	0	volts
Grid-No.2 (Screen-Grid) Supply Voltage	330	volts
Grid-No.2 Voltage	See curve page 96	
Grid-No.1 (Control-Grid) Voltage, Positive-bias value	0	volts
Plate Dissipation	2.5	watts
Grid-No.2 Input:		
For grid-No.2 voltages up to 165 volts	0.6	watt
For grid-No.2 voltages between 165 and 330 volts	See curve page 96	

**CHARACTERISTICS**

Plate Supply Voltage	125	volts
Grid-No.3 Voltage	0	volts
Grid-No.2 Supply Voltage	125	volts
Grid-No.1 Supply Voltage	0	volts
Cathode-Bias Resistor	56	ohms
Plate Resistance (Approx.)	160000	ohms
Transconductance	14000	$\mu$ mhos
Plate Current	15	mA
Grid-No.2 Current	4	mA
Grid-No.1 Voltage (Approx.) for transconductance of 600 $\mu$ mhos	—4.5	volts

**MAXIMUM CIRCUIT VALUES**

Grid-No.1-Circuit Resistance:		
For fixed-bias operation	0.25	megohm
For cathode-bias operation	1	megohm



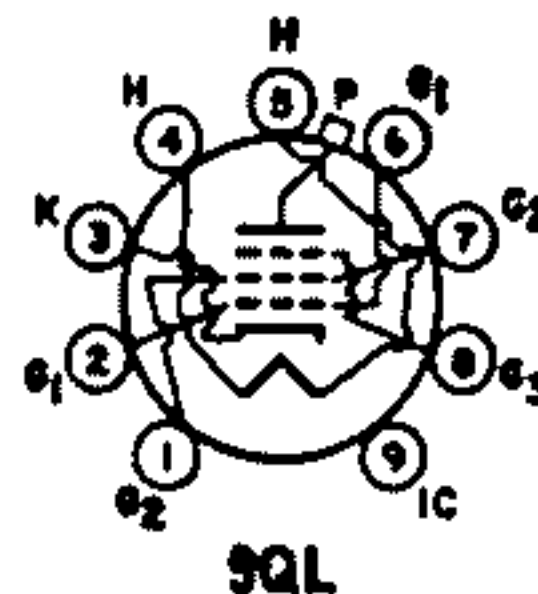
**6JE6**

Refer to chart at end of section.

**6JE6A**

**BEAM POWER TUBE**

Novar type used as horizontal-deflection amplifier in color television receivers. Outlines section, 32A; requires novar 9-contact socket. Type 24JE6A is identical to type 6JE6A except for heater ratings.



	<b>6JE6A</b>	<b>24JE6A</b>	
Heater Voltage (ac/dc)	6.3	24	volts
Heater Current	2.5	0.6	amperes
Heater Warm-up Time	—	11	seconds
Heater-Cathode Voltage:			
Peak value	±200 max	±200 max	volts
Average value	100 max	100 max	volts
Direct Interelectrode Capacitances (Approx.):			
Grid No.1 to Plate		0.56	pF
Grid No.1 to Cathode, Heater, Grid No.2, and Grid No.3		22	pF
Plate to Cathode, Heater, Grid No.2, and Grid No.3		11	pF

**Class A<sub>1</sub> Amplifier**

<b>CHARACTERISTICS</b>	<b>Triode Connection<sup>a</sup></b>	<b>Pentode Connection</b>	
Plate Voltage	125	70, 175	volts
Grid No.3 (Suppressor Grid)	Connected to cathode at socket		
Grid-No.2 (Screen-Grid) Voltage	—	125, 125	volts
Grid-No.1 (Control-Grid) Voltage	-25	0, -25	volts
Amplification Factor	8	—	
Plate Resistance (Approx.)	—	—	ohms
Transconductance	—	—	μmhos
Plate Current	—	600†, 130	mA
Grid-No.2 Current	—	36†, 2.8	mA
Grid-No.1 Voltage (Approx.) for plate current of 1 mA	—	—, -54	volts

† This value can be measured by a method involving a recurrent waveform such that the maximum ratings of the tube will not be exceeded.

<sup>a</sup> Grid No.2 connected to plate.

**Horizontal-Deflection Amplifier**

For operation in a 525-line, 30-frame system

**MAXIMUM RATINGS (Design-Maximum Values)**

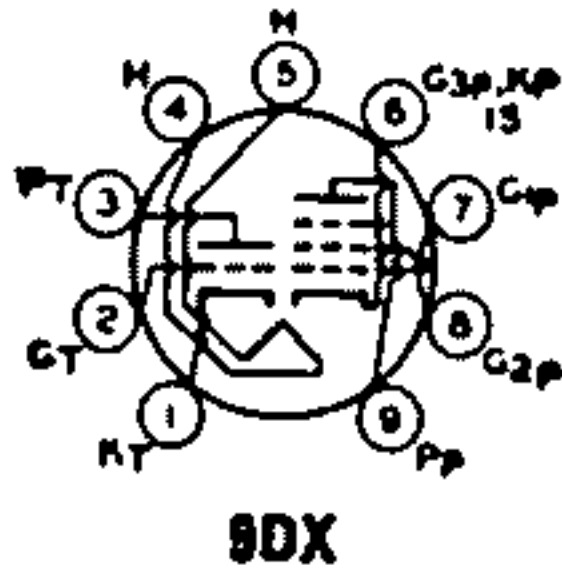
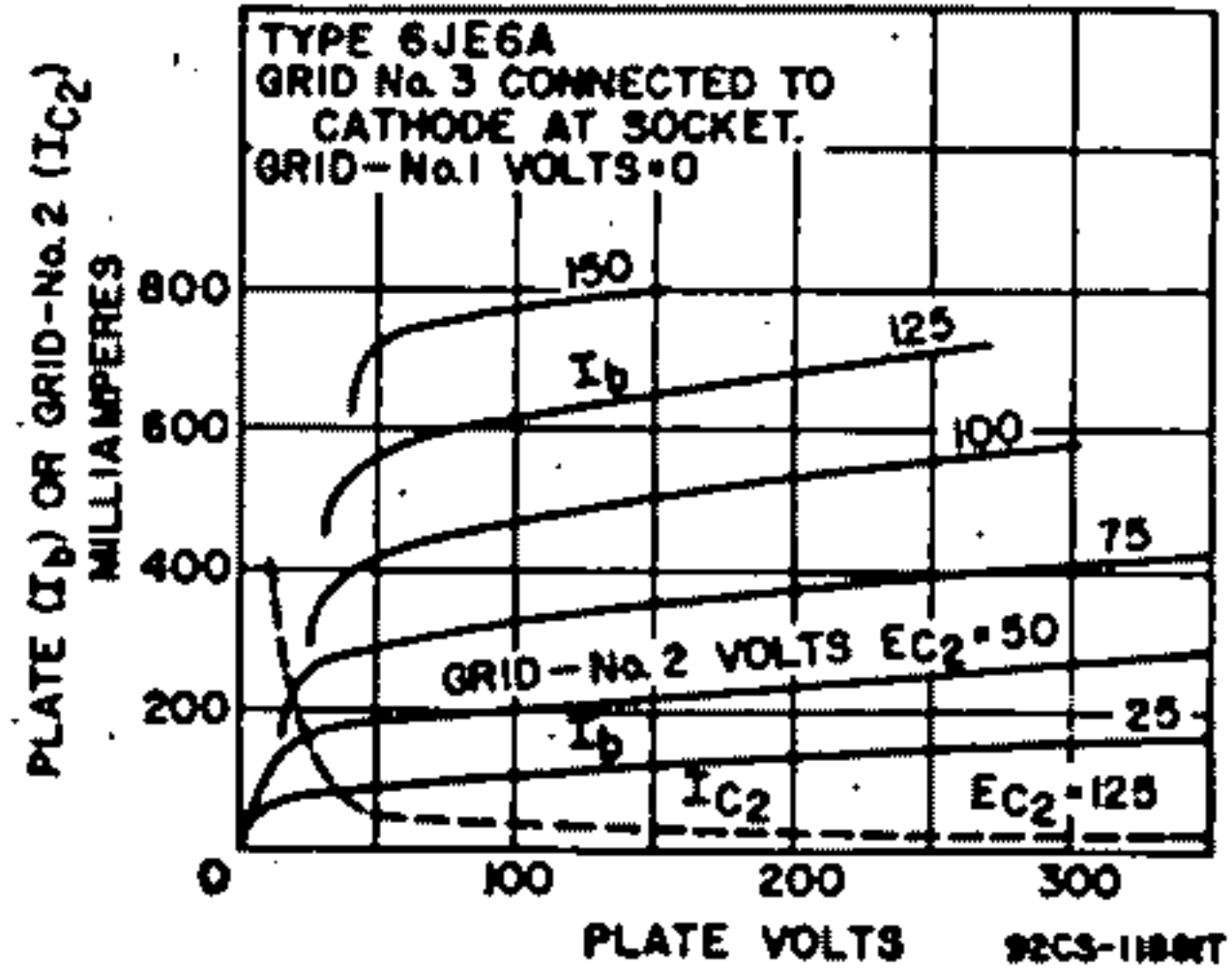
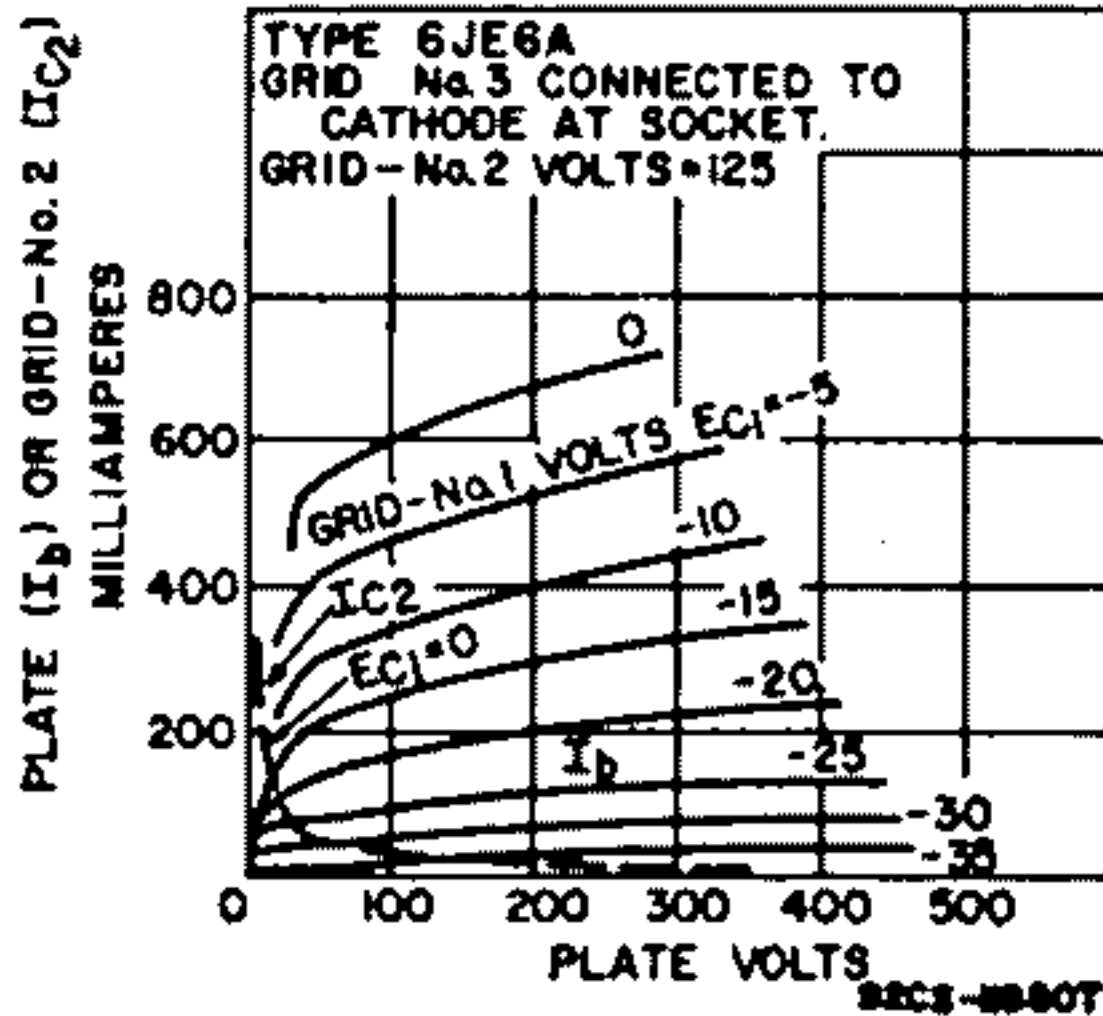
DC Plate Supply Voltage	990	volts
Peak Positive-Pulse Plate Voltage <sup>‡</sup>	7500	volts

Peak Negative-Pulse Plate Voltage .....	-1100	volts
DC Grid-No.3 Voltage* .....	75	volts
DC Grid-No.2 Voltage .....	220	volts
Peak Negative-Pulse Grid-No.1 Voltage .....	-330	volts
Peak Cathode Current .....	1200	mA
Average Cathode Current .....	350	mA
Grid-No.2 Input .....	3.2	watts
Plate Dissipation* .....	30	watts
Bulb Temperature (At hottest point) .....	250	°C

**MAXIMUM CIRCUIT VALUES**

Grid-No.1-Circuit Resistance:		
For grid-resistor-bias operation* .....	0.47	megohm
For plate-pulsed operation (horizontal-deflection circuits only) .....	10	megohms

- # Pulse duration must not exceed 15% of a horizontal scanning cycle (10 microseconds).
- \* In this service, a positive voltage may be applied to grid No.3 to minimize "snivets" interference; a typical value for this voltage is 30 volts.
- \* A bias resistor or other means is required to protect the tube in absence of excitation.



**HIGH-MU TRIODE—  
SHARP-CUTOFF PENTODE**

**6JE8  
11JE8**

Miniature type used in television receiver applications. The triode unit is used as a voltage amplifier or sync separator, and the pentode unit as a video amplifier. Outlines section, 6E; requires miniature 9-contact socket. Type 11JE8 is identical with type 6JE8 except for heater ratings.

Heater Voltage (ac/dc) .....	6.2	10.9	volts
Heater Current .....	0.78	0.45	ampere
Heater Warm-up Time (Average) .....	—	11	seconds
Heater-Cathode Voltage:			
Peak value .....	±200 max	±200 max	volts
Average value .....	100 max	100 max	volts

**Class A<sub>1</sub> Amplifier**

<b>MAXIMUM RATINGS (Design-Maximum Values)</b>		<b>Triode Unit</b>	<b>Pentode Unit</b>	
Plate Voltage .....	300	330	330	volts
Grid-No.2 (Screen-Grid) Supply Voltage .....	—	—	330	volts
Grid-No.2 Voltage .....	—	See curve page 96		
Grid-No.1 (Control-Grid) Voltage Positive-bias value .....	0	0	0	volts
Plate Dissipation .....	1	5	5	watts
Grid-No.2 Input:				
For plate voltages up to 165 volts .....	—	1.5*	—	watts
For plate voltages between 165 and 330 volts ..	—	See curve page 96		

**CHARACTERISTICS**

Plate Voltage .....	200	60	250	volts
Grid-No.2 Voltage .....	—	170	170	volts
Grid-No.1 Voltage .....	-2	0	—	volts
Cathode-Bias Resistor .....	—	—	82	ohms
Amplification Factor .....	70	—	—	
Plate Resistance (Approx.) .....	—	—	0.14	megohm
Transconductance .....	4200	—	12000	μmhos



Plate Current .....	4.5	48*	22	mA
Grid-No.2 Current .....	—	12*	4	mA
Grid-No.1 Voltage (Approx.) for plate current of 10 $\mu$ A .....	-5	—	-10	volts

**MAXIMUM CIRCUIT VALUES**

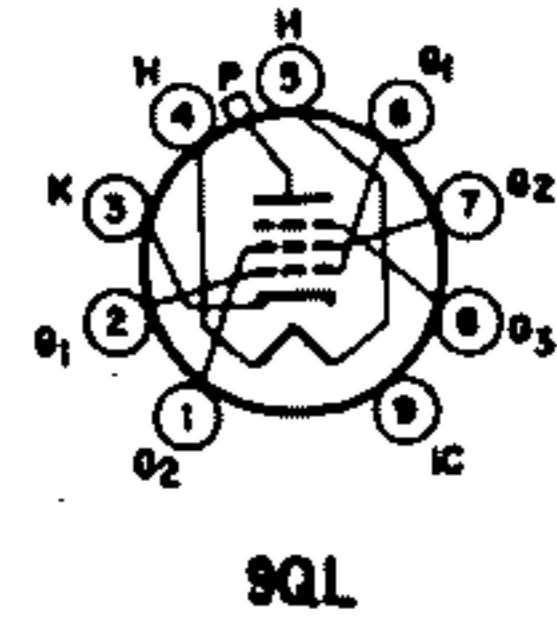
Grid-No.1-Circuit Resistance:				
For fixed-bias operation .....	0.5	0.25		megohm
For cathode-bias operation .....	1	1		megohm

\* Grid-No.2 input may reach 2 watts for plate-dissipation values of 4 watts or less.  
 † This value may be measured by a method involving a recurrent waveform such that the maximum ratings of the tube will not be exceeded.

**6JF6**  
22JF6

**BEAM POWER TUBE**

Novar type used as horizontal-deflection amplifier in black-and-white television receivers. Outlines section, 18A; requires novar 9-contact socket. Type 22JF6 is identical with type 6JF6 except for heater ratings.



	<b>6JF6</b>	<b>22JF6</b>	
Heater Voltage (ac/dc) .....	6.3	22	volts
Heater Current .....	1.6	0.45	amperes
Heater Warm-up Time (Average) .....	—	11	seconds
Heater-Cathode Voltage:			
Peak value .....	$\pm 200$ max	$\pm 200$ max	volts
Average value .....	100 max	100 max	volts
Direct Interelectrode Capacitances (Approx.):			
Grid No.1 to Plate .....		1.2	pF
Grid No.1 to Cathode, Heater, Grid No.2, and Grid No.3 .....		22	pF
Plate to Cathode, Heater, Grid No.2, and Grid No.3 .....		9	pF

**Class A<sub>1</sub> Amplifier**

**CHARACTERISTICS**

	Triode* Connection		Pentode Connection		
	125	—	50	130	
Plate Voltage .....	—	6500	—	—	volts
Peak Positive-Pulse Plate Voltage# ..	—	—	—	—	volts
Grid No.3 (Suppressor Grid) .....	Connected to cathode at socket				
Grid-No.2 (Screen-Grid) Voltage .....	—	125	125	125	volts
Grid-No.1 (Control-Grid) Voltage ..	-20	—	0	-20	volts
Triode Amplification Factor .....	4.1	—	—	—	
Plate Resistance (Approx.) .....	—	—	—	12000	ohms
Transconductance .....	—	—	—	10000	$\mu$ mhos
Plate Current .....	—	—	525†	80	mA
Grid-No.2 Current .....	—	—	32†	2.5	mA
Grid-No.1 Voltage for plate current of 1 mA .....	—	-125	—	-40	volts

**Horizontal-Deflection Amplifier**

For operation in a 525-line, 30-frame system

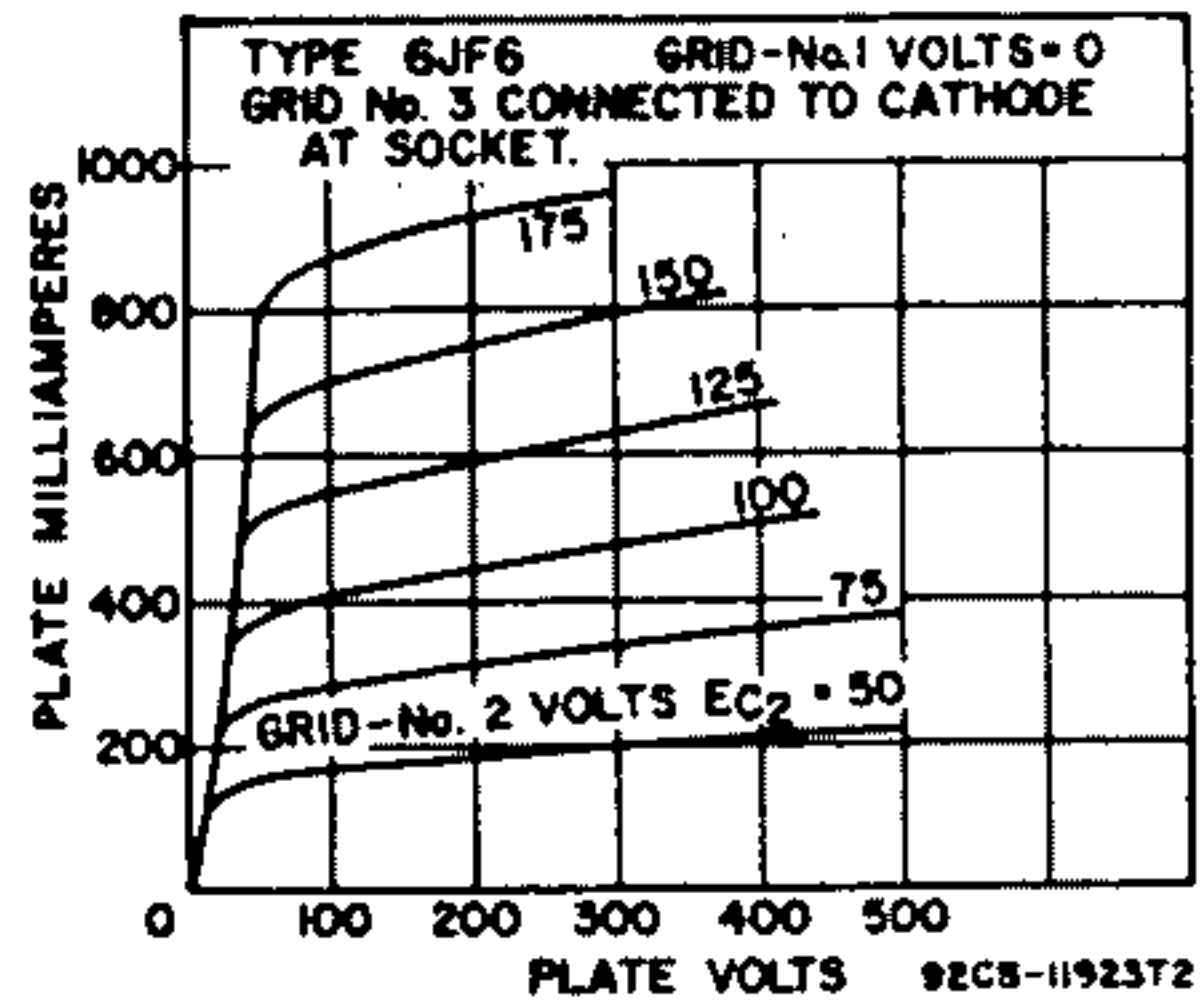
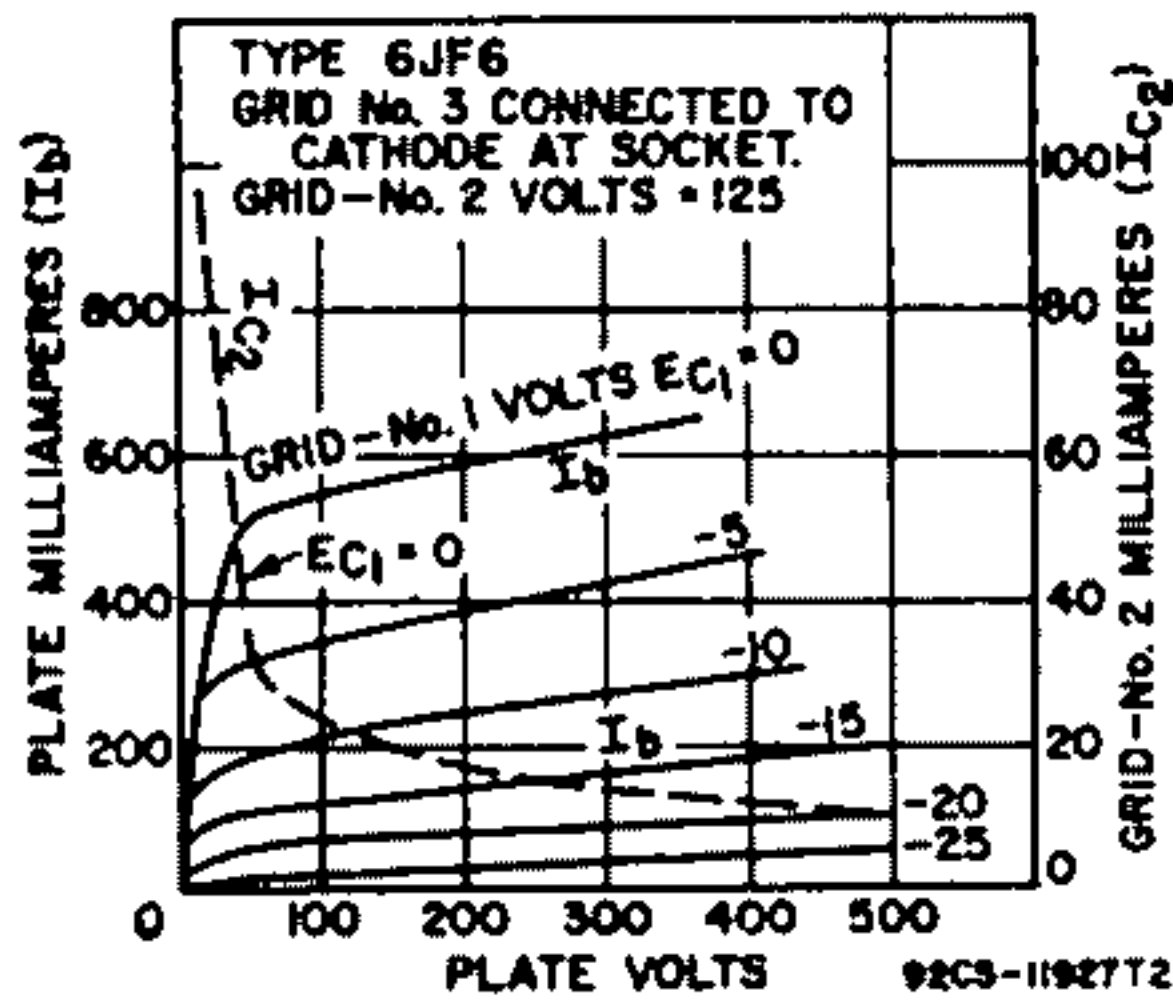
**MAXIMUM RATINGS (Design-Maximum Values)**

DC Plate Supply Voltage .....	770	volts
Peak Positive-Pulse Plate Voltage# .....	6500	volts
Peak Negative-Pulse Plate Voltage .....	-1500	volts
DC Grid-No.3 Voltage* .....	100	volts
DC Grid-No.2 Voltage .....	220	volts
Peak Negative-Pulse Grid-No.1 Voltage .....	-330	volts
Peak Cathode Current .....	950	mA
Average Cathode Current .....	275	mA
Grid-No.2 Input .....	3.5	watts
Plate Dissipation† .....	17	watts
Bulb Temperature (At hottest point) .....	240	°C

**MAXIMUM CIRCUIT VALUES**

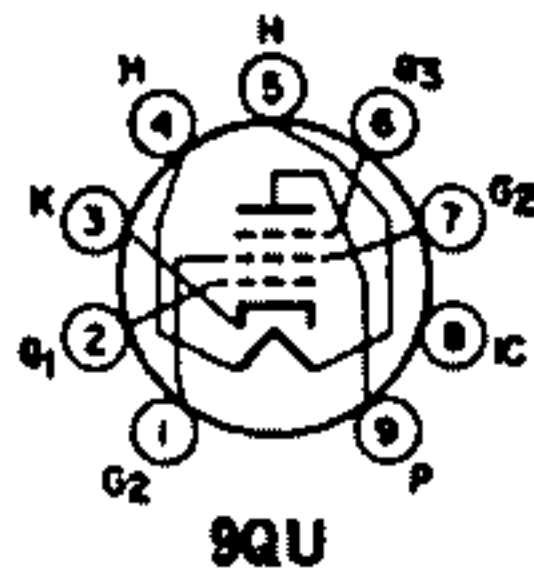
Grid-No.1-Circuit Resistance:		
For grid-resistor-bias operation‡ .....	0.47	megohm
For plate-pulsed operation (horizontal-deflection circuits only) .....	10	megohms

\* Grid-No.2 connected to plate at socket.  
 † This value can be measured by a method involving a recurrent waveform such that the maximum ratings of the tube will not be exceeded.  
 # Pulse duration must not exceed 15% of a horizontal scanning cycle (10 microseconds).  
 \* In this service, a positive value may be applied to grid No.3 to minimize "anivets" interference; a typical value for this voltage is 50 volts.  
 ‡ A bias resistor or other means is required to protect the tube in absence of excitation.



Refer to chart at end of section.

6JG6



**BEAM POWER TUBE**

**6JG6A**

17JG6A, 22JG6A

Novar type used as horizontal-deflection amplifier in low-B+, black-and-white television receivers. Outlines section, 31B; requires novar 9-contact socket. For curves of average plate characteristics, refer to type 6JF6. Types 17JG6A and 22JG6A are identical with type 6JG6A except for heater ratings.

	6JG6A	17JG6A	22JG6A	
Heater Voltage (ac/dc)	6.8	16.8	22	volts
Heater Current	1.6	0.6	0.45	amperes
Heater Warm-up Time (Average)	—	11	11	seconds
Heater-Cathode Voltage:				
Peak value	±200 max	±200 max	±200 max	volts
Average value	100 max	100 max	100 max	volts
Direct Interelectrode Capacitances:				
Grid No.1 to Plate	—	—	0.7	pF
Grid No.1 to Cathode, Heater, Grid No.2, and Grid No. 3	—	—	22	pF
Plate to Cathode, Heater, Grid No.2, and Grid No.3	—	—	9	pF

**Class A<sub>1</sub> Amplifier**

**CHARACTERISTICS**

	Triode <sup>a</sup> Connection	Pentode Connection	
Plate Voltage	125	50 130	volts
Grid No.3 (Suppressor Grid)	—	Connected to cathode at socket	
Grid-No.2 (Screen-Grid) Voltage	—	125 125	volts
Grid-No.1 (Control-Grid) Voltage	-20	0 -20	volts
Amplification Factor	4.1	—	
Plate Resistance (Approx.)	—	— 12000	ohms
Transconductance	—	— 10000	μmhos
Plate Current	—	525* 80	mA
Grid-No.2 Current	—	32* 2.6	mA
Grid-No.1 Voltage (Approx.), for plate current of 1 mA	—	— -40	volts

\* With grid No.2 connected to plate at socket.

\* This value can be measured by a method involving a recurrent waveform such that the maximum ratings of the tube will not be exceeded.

**Horizontal-Deflection Amplifier**

For operation in a 525-line, 30-frame system

**MAXIMUM RATINGS (Design-Maximum Values)**

DC Plate Supply Voltage	770	volts
Peak Positive-Pulse Plate Voltage*	6500	volts
Peak Negative-Pulse Plate Voltage	-1500	volts
DC Grid-No.3 Voltage*	75	volts
DC Grid-No.2 Voltage	220	volts
DC Grid-No.1 Voltage, Negative-bias value	-55	volts
Peak Negative-Pulse Grid-No.1 Voltage	-380	volts
Peak Cathode Current	950	mA

Average Cathode Current .....	275	mA
Plate Dissipation† .....	17	watts
Grid-No.2 Input .....	3.5	watts
Bulb Temperature (At hottest point) .....	240	°C

**MAXIMUM CIRCUIT VALUE**

Grid-No.1-Circuit Resistance, for grid-No.1-resistor-bias operation	2.2	megohms
---	-----	---------

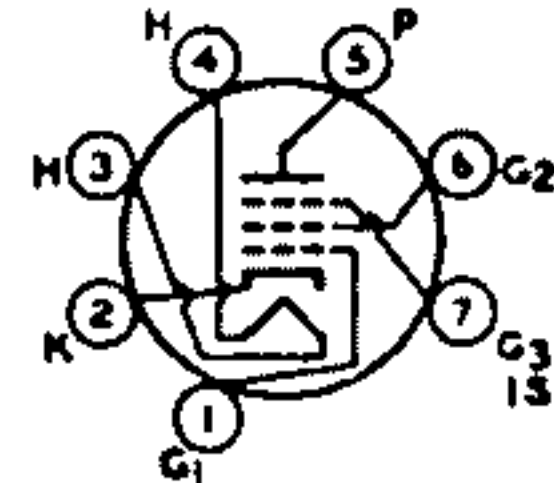
# Pulse duration must not exceed 15% of a horizontal scanning cycle (10 microseconds).

\* In a horizontal-deflection-amplifier service, a positive voltage (typical value, 30 volts) may be applied to grid No.3 to reduce "snivets" interference, which may occur in both vhf and uhf television receivers.

† A bias resistor or other means is required to protect the tube in absence of excitation.

# 6JH6

## SEMIREMOTE-CUTOFF PENTODE



7CM

Miniature type used in the gain-controlled picture if-amplifier stages of color and black-and-white television receivers. Outlines section, 5C; requires miniature 7-contact socket. For curves of average plate characteristics, refer to type 6BZ6.

Heater Voltage (ac/dc) .....	6.3	volts	
Heater Current .....	0.8	ampere	
Heater-Cathode Voltage:			
Peak value .....	±200 max	volts	
Average value .....	100 max	volts	
Direct Interelectrode Capacitances:			
Grid No.1 to Plate .....	Unshielded 0.025 max	Shielded* 0.015 max	pF
Grid No.1 to Cathode, Heater, Grid No.2, Grid No.3, and Internal Shield .....	7	7	pF
Plate to Cathode, Heater, Grid No.2, Grid No.3, and Internal Shield .....	2	3	pF

\* With external shield connected to cathode.

### Class A<sub>1</sub> Amplifier

**MAXIMUM RATINGS (Design-Maximum Values)**

Plate Voltage .....	300	volts
Grid-No.3 (Suppressor-Grid) Voltage, Positive value .....	0	volts
Grid-No.2 (Screen-Grid) Supply Voltage .....	300	volts
Grid-No.2 Voltage .....	See curve page 96	
Grid-No.1 (Control-Grid) Voltage, Positive-bias value .....	0	volts
Grid-No.2 Input:		
For grid-No.2 voltages up to 150 volts .....	0.55	watt
For grid-No.2 voltages between 150 and 300 volts .....	See curve page 96	

**CHARACTERISTICS**

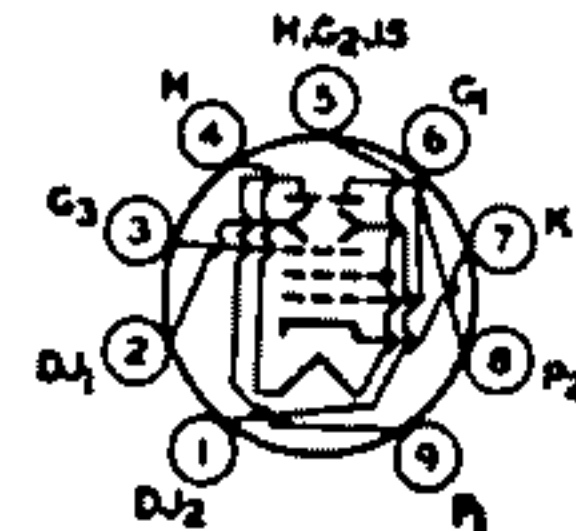
Plate Supply Voltage .....	125	volts
Grid No.3 .....	Connected to cathode at socket	
Grid-No.2 Supply Voltage .....	125	volts
Cathode-Bias Resistor .....	56	ohms
Plate Resistance (Approx.) .....	0.26	megohm
Transconductance .....	8000	μmhos
Transconductance Range for grid-No.1 voltage of -4.5 volts and cathode-bias resistor of 56 ohms .....	400-900	μmhos
Plate Current .....	14	mA
Grid-No.2 Current .....	3.5	mA
Grid-No.1 Voltage (Approx.) for transconductance of 50 μmhos .....	-19	volts

**MAXIMUM CIRCUIT VALUES**

Grid-No.1-Circuit Resistance:		
For fixed-bias operation .....	0.25	megohm
For cathode-bias operation .....	1	megohm

# 6JH8

## BEAM-DEFLECTION TUBE



9DP

Miniature type used in color-demodulator and burst-gate circuits in color television receivers. This type has two plates and two deflecting electrodes; the control grid varies beam deflection. Outlines section, 6E; requires miniature 9-contact socket. Pin 5 should be connected to cathode at socket. The 6JH8 should be



so located in the equipment that it is not subjected to stray magnetic fields.

Heater Voltage (ac/dc) .....	6.3	volts
Heater Current .....	0.3	amperes
Direct Interelectrode Capacitances:		
Grid No.1 to All Other Electrodes, Except Both Plates .....	7.5	pF
Grid No.1 to Deflecting Electrode No.1 .....	0.04 max	pF
Grid No.1 to Deflecting Electrode No.2 .....	0.07 max	pF
Plate No.1 to All Other Electrodes .....	5.0	pF
Plate No.2 to All Other Electrodes .....	5.0	pF
Plate No.1 to Plate No.2 .....	0.4	pF
Deflecting Electrode No.1 to All Other Electrodes .....	4.8	pF
Deflecting Electrode No.2 to All Other Electrodes .....	4.8	pF
Deflecting Electrode No. 1 to Deflecting Electrode No.2 .....	0.38	pF

**Color TV Demodulator**

**MAXIMUM RATINGS (Design-Maximum Values)**

Plate Voltage (Each Plate) .....	330	volts
Peak Deflecting-Electrode Voltage (Each Electrode):		
Negative value .....	-165	volts
Positive value .....	165	volts
Grid-No.3 (Accelerating-Grid) Voltage .....	330	volts
Grid-No.1 (Control-Grid) Voltage, Positive-bias value .....	0	volts
Cathode Current .....	33	mA
Plate Dissipation (Each Plate) .....	3	watts
Grid-No.3 Input .....	1	watt

**MAXIMUM CIRCUIT VALUES**

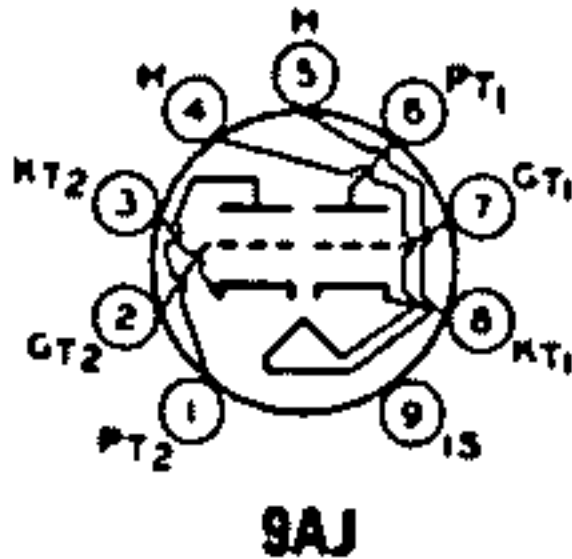
Grid-No.1 Circuit Resistance:		
For fixed-bias operation .....	0.1	megohm
For cathode-bias operation .....	0.25	megohm

**Class A<sub>1</sub> Amplifier**

With both plates connected together and with both deflecting electrodes connected to cathode at socket

**CHARACTERISTICS**

Plate-No.1 Supply Voltage .....	250	volts
Plate-No.2 Supply Voltage .....	250	volts
Grid-No.3 Voltage .....	250	volts
Cathode-Bias Resistor .....	220	ohms
Transconductance .....	4400	μmbos
Total Plate Current .....	14	mA
Grid-No.3 Current .....	1.5	mA
Grid-No.1 Voltage (Approx.) for total plate current of 10 μA .....	-13	volts



**DUAL TRIODE**

**6JK8**

Miniature type used as combined rf-amplifier and mixer-oscillator tube in FM tuners. Unit No.1 is used as an oscillator-mixer, and unit No.2 is used as an rf amplifier. Outlines section, 6B; requires miniature 9-contact socket and may be mounted in any position.

Heater Voltage (ac/dc) .....	6.3	volts
Heater Current .....	0.4	ampere
Peak Heater-Cathode Voltage .....	±100 max	volts
Direct Interelectrode Capacitances:	Unit No.1	Unit No.2
Grid to Plate .....	1.4	0.6
Grid to Cathode, Heater, and Internal Shield ..	3	5
Plate to Cathode, Heater, and Internal Shield ..	1	4
Heater to Cathode .....	2.8	2.8
Grid of Unit No.1 to Grid of Unit No.2 .....		0.003 max
Plate of Unit No.1 to Plate of Unit No.2 .....		0.009 max

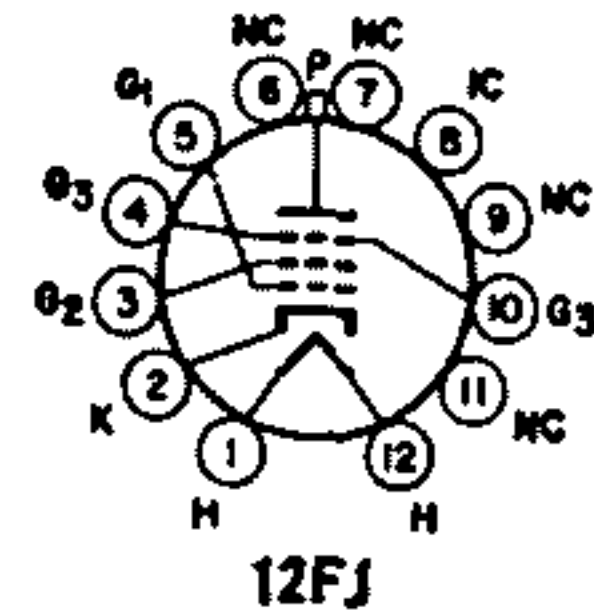
**Class A<sub>1</sub> Amplifier**

<b>MAXIMUM RATINGS (Design-Maximum Values)</b>	Unit No.1	Unit No.2	
Plate Voltage .....	165	200	volts
Negative Grid Voltage .....	-50	-50	volts
Average Cathode Current .....	22	22	mA
Plate Dissipation .....	1	2	watts
<b>CHARACTERISTICS</b>			
Plate Voltage .....	190	135	volts

Grid Voltage .....	-1	-1.2	volts
Amplification Factor .....	55	70	
Plate Resistance (Approx.) .....	8000	5400	ohms
Transconductance .....	6800	18000	$\mu$ mbhos
Plate Current .....	5.3	10	mA
Grid Voltage (Approx.):			
For plate current of 20 $\mu$ A .....	-4.4	—	volts
For transconductance of 150 $\mu$ mbhos .....	—	-5.5	volts
For transconductance of 1500 $\mu$ mbhos .....	—	-2.8	volts
<b>MAXIMUM CIRCUIT VALUES</b>			
Grid-Circuit Resistance, for cathode-bias operation ..	1	1	megohm

**6JM6**  
**6JM6A**  
17JM6  
17JM6A

**BEAM POWER TUBE**



Duodecar types used as horizontal-amplifier tubes in color and black-and-white television receivers. Outlines section, 16A; require duodecar 12-contact socket. Types 17JM6 and 17JM6A are identical with types 6JM6 and 6JM6A except for heater ratings.

	<b>6JM6</b>	<b>17JM6</b>	
	<b>6JM6A</b>	<b>17JM6A</b>	
Heater Voltage (ac/dc) .....	6.3	16.8	volts
Heater Current .....	1.2	0.45	amperes
Heater Warm-up Time (Average) .....	—	11	seconds
Heater-Cathode Voltage:			
Peak value .....	$\pm$ 200 max	$\pm$ 200 max	volts
Average value .....	100 max	100 max	volts
Direct Interelectrode Capacitances:			
Grid No.1 to Plate .....		0.6	pF
Grid No.1 to Cathode, Heater, Grid No.2, and Grid No.3 .....		16	pF
Plate to Cathode, Heater, Grid No. 2, and Grid No. 3 .....		7.0	pF

**Class A<sub>1</sub> Amplifier**

<b>CHARACTERISTICS</b>	<b>Pentode Connection</b>			<b>Triode** Connection</b>	
	5000	60*	250	150	volts
Plate Voltage .....	Connected to cathode at socket				
Grid-No.3 (Suppressor-Grid) .....	150	150	150	150	volts
Grid-No.2 (Screen-Grid) Voltage .....	—	0	-22.5	-22.5	volts
Grid-No.1 (Control-Grid) Voltage .....	—	—	18000**	—	ohms
Plate Resistance (Approx.) .....	—	—	7800	—	$\mu$ mbhos
Transconductance .....	—	345*	65	—	mA
Plate Current .....	—	27*†	1.8	—	mA
Grid-No.2 Current .....	—	—	—	—	
Grid-No.1 Voltage (Approx.) for plate current of 1 $\mu$ A .....	-100	—	-42	—	volts
Amplification Factor .....	—	—	—	4.4	

<b>MAXIMUM CIRCUIT VALUE</b>			
Grid-No.1-Circuit Resistance .....		1	megohm

- \* This value can be measured by a method utilizing a recurrent waveform such that the maximum ratings of the tube will not be exceeded.
- \*\* Grid No.2 tied to plate.
- \* For type 6JM6A this value is 55.
- \*\* For type 6JM6A this value is 15000.
- † For type 6JM6A this value is 30.

**Horizontal-Deflection Amplifier**

For operation in a 525-line, 30-frame system

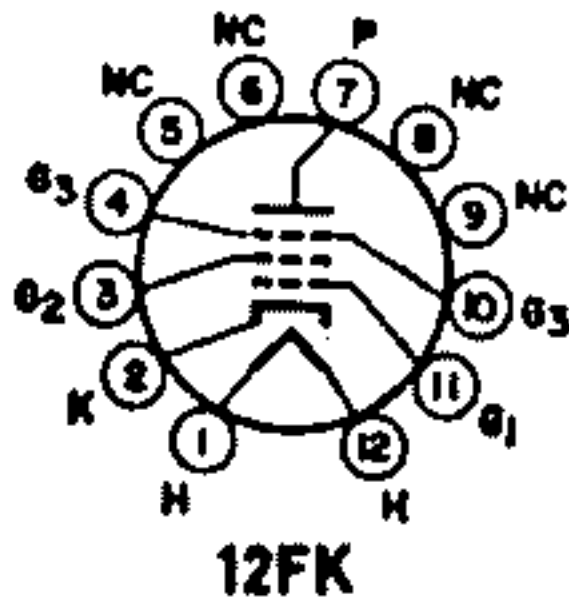
<b>MAXIMUM RATINGS (Design-Maximum Values)</b>		
DC Plate Supply Voltage .....	770	volts
Peak Positive-Pulse Plate Voltage# .....	6500	volts
Peak Negative-Pulse Plate Voltage .....	-1500	volts
DC Grid-No.3 Voltage .....	70	volts
DC Grid-No.2 Voltage .....	220	volts
DC Grid-No.1 Voltage, Negative-bias value .....	-55	volts
Peak Negative-Pulse Grid-No.1 Voltage .....	-330	volts
Average Cathode Current .....	175	mA
Peak Cathode Current .....	550	mA
Plate Dissipation## .....	17.5	watts

Grid-No.2 Input ..... 3.5 watts  
 Bulb Temperature (At hottest point) ..... 220 °C  
 # Pulse duration must not exceed 15% of a horizontal scanning cycle (10 microseconds).  
 ## A bias resistor or other means is required to protect the tube in absence of excitation.

**6JN6**

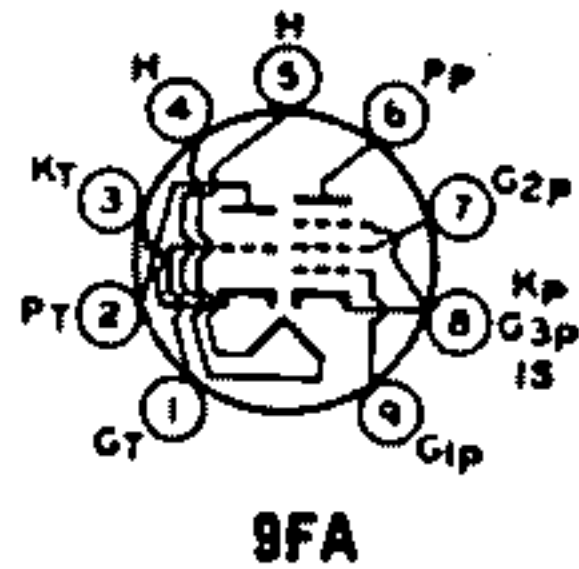
**BEAM POWER TUBE**

12JN6, 17JN6



Duodecar type used as horizontal-amplifier tube in color and black-and-white television receivers. Outlines section, 15A; requires duodecar 12-contact socket. This type is electrically identical with type 6JM6 except that it has a slightly lower grid-No.1-to-plate capacitance. Types 12JN6 and 17JN6 are identical with type 6JN6 except for heater ratings.

	6JN6	12JN6	17JN6	
Heater Voltage (ac/dc) .....	6.3	12.6	16.8	volts
Heater Current .....	1.2	0.6	0.45	amperes
Heater Warm-up Time (Average) .....	—	11	11	seconds
Direct Interelectrode Capacitances:				
Grid No.1 to Plate .....			0.34	pF
Grid No.1 to Cathode, Heater, Grid No.2, and Grid No.3 .....			16	pF
Plate to Cathode, Heater, Grid No.2, and Grid No.3 .....			7.0	pF



**MEDIUM-MU TRIODE—  
SHARP-CUTOFF PENTODE**

**6JN8**

12JN8, 19JN8

Miniature type used as FM converter and rf amplifier in radio receivers. Outlines section, 6B; requires miniature 9-contact socket. Types 12JN8 and 19JN8 are identical with type 6JN8 except for heater ratings.

	6JN8	12JN8	19JN8	
Heater Voltage (ac/dc) .....	6.3	12.6	18.9	volts
Heater Current .....	0.45	0.225	0.15	ampere
Heater Warm-up Time (Average) .....	11	—	—	seconds
Heater-Cathode Voltage:				
Peak value .....	±200 max	±200 max	±200 max	volts
Average value .....	100 max	100 max	100 max	volts
Direct Interelectrode Capacitances:*				
Pentode Unit:				
Grid No.1 to Plate .....			0.01	pF
Grid No.1 to Cathode, Heater, Grid No.2, Grid No.3, and Internal Shield .....			5.5	pF
Plate to Cathode, Heater, Grid No.2, Grid No.3, and Internal Shield .....			3.4	pF
Triode Unit:				
Grid to Plate .....			1.7	pF
Grid to Cathode, Heater, Pentode Cathode, Grid No.3, and Internal Shield .....			3.2	pF
Plate to Cathode, Heater, Pentode Cathode, Grid No.3, and Internal Shield .....			2.2	pF

\* With external shield connected to cathode of unit under test.

**Class A<sub>1</sub> Amplifier**

	Triode Unit	Pentode Unit	
<b>MAXIMUM RATINGS (Design-Maximum Values)</b>			
Plate Voltage .....	300	300	volts
Grid-No.2 (Screen-Grid) Supply Voltage .....	—	300	volts
Grid-No.2 Voltage .....	—	See curve page 96	
Grid-No.1 (Control-Grid) Voltage, Positive-bias value .....	0	0	volts
Plate Dissipation .....	2.5	2.5	watts
Grid-No.2 Input:			
For grid-No.2 voltages up to 150 volts .....	—	0.55	watt
For grid-No.2 voltages between 150 and 300 volts .....	—	See curve page 96	
<b>CHARACTERISTICS</b>			
Plate Voltage .....	125	125	volts
Grid-No.2 Voltage .....	—	125	volts
Grid-No.1 Voltage .....	—1	—1	volt
Amplification Factor .....	46	—	



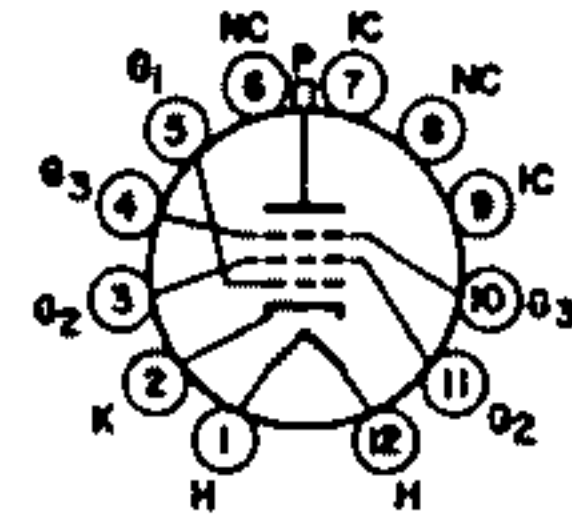
Plate Resistance (Approx.) .....	5400	200000	ohms
Transconductance .....	8500	7500	μmhos
Plate Current .....	13.5	12	mA
Grid-No.2 Current .....	—	4	mA
Grid-No.1 Voltage (Approx.) for plate current of 10 μA .....	-8	-8	volts
<b>MAXIMUM CIRCUIT VALUES</b>			
Grid-No.1-Circuit Resistance:			
For fixed-bias operation .....	2.2	2.2	megohms
For cathode-bias operation .....	2.2	2.2	megohms

**6JS6**

Refer to chart at end of section.

**6JS6**  
**6JS6A**  
31JS6A

**BEAM POWER TUBE**



12FY

Duodecar types used as horizontal-deflection amplifiers in color and black-and-white television receivers. Outlines section, 16B; require duodecar 12-contact socket.

	<b>6JS6</b>	<b>6JS6A</b>	<b>31JS6A</b>	
Heater Voltage (ac/dc) .....	6.3	6.3	31.5	volts
Heater Current .....	2.25	2.25	0.45	amperes
Heater Warm-up Time (Average) .....	—	—	11	seconds
Heater-Cathode Voltage:				
Peak value .....	±200 max	±200 max	±200 max	volts
Average value .....	100 max	100 max	100 max	volts
Direct Interelectrode Capacitances:				
Grid No.1 to Plate .....	—	—	0.7	pF
Grid No.1 to Cathode, Heater, Grid No.2, and Grid No.3 .....	—	—	24	pF
Plate to Cathode, Heater, Grid No.2, and Grid No.3 .....	—	—	10	pF

**Class A<sub>1</sub> Amplifier**

**CHARACTERISTICS**

	<b>Triode†† Connection</b>		<b>Pentode Connection</b>		
Plate Voltage .....	125	5000	70*	175	volts
Grid No.3 (Suppressor Grid) .....	—	—	Connected to cathode at socket		
Grid-No.2 (Screen-Grid) Voltage .....	125	125	125	125	volts
Grid-No.1 (Control-Grid) Voltage .....	-25	—	0	-25	volts
Plate Resistance (Approx.) .....	—	—	—	5600	ohms
Transconductance .....	—	—	—	11300	μmhos
Plate Current .....	—	—	570†	125	mA
Grid-No.2 Current .....	—	—	34†	4.5	mA
Grid-No.1 Voltage (Approx.) for plate current of 1 mA .....	—	-140	—	-54	volts
Triode Amplification Factor .....	—	—	—	—	

**MAXIMUM CIRCUIT VALUE**

Grid-No.1-Circuit Resistance .....	1	megohm
------------------------------------	---	--------

† These values can be measured by a method involving a recurrent waveform such that the maximum ratings of the tube will not be exceeded.

†† Grid No.2 connected to plate.

**Horizontal-Deflection Amplifier**

For operation in a 525-line, 30-frame system

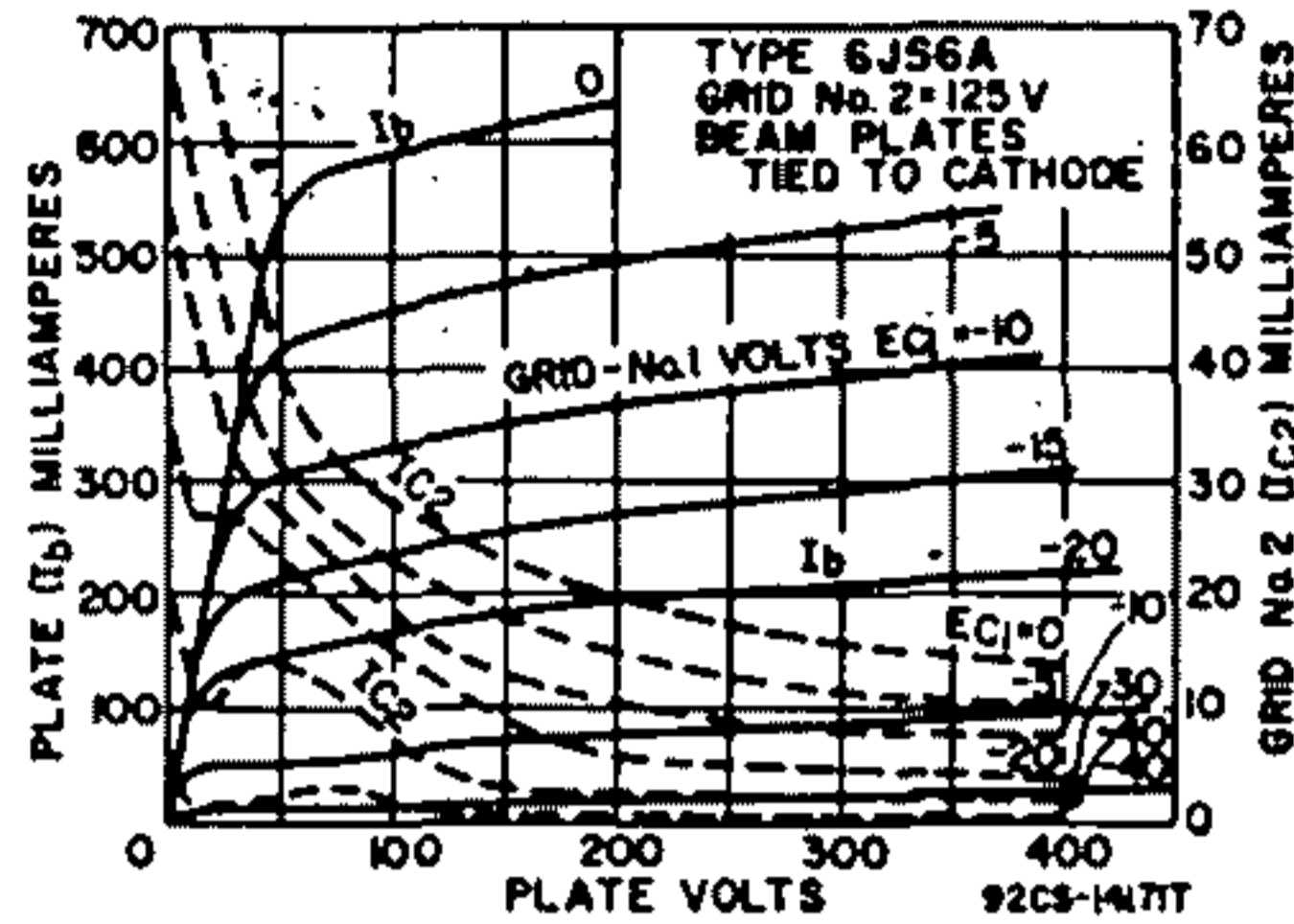
**MAXIMUM RATINGS (Design-Maximum Values)**

DC Plate Supply Voltage .....	990	volts
Peak Positive-Pulse Plate Voltage# .....	7500	volts
Peak Negative-Pulse Plate Voltage .....	1100	volts
DC Grid-No.3 Voltage .....	70	volts
DC Grid-No.2 Voltage .....	190	volts
Peak Negative-Pulse Grid-No.1 Voltage .....	-250	volts
Average Cathode Current .....	315	mA
Peak Cathode Current .....	1100	mA
Plate Dissipation** .....	28	watts
Grid-No.2 Input .....	5.5	watts
Bulb Temperature (At hottest point) .....	225	°C

# Pulse duration must not exceed 15% of one horizontal scanning cycle (10 microseconds).

\*\* A bias resistor or other means is required to protect the tube in absence of excitation.

\* For the 6JS6 this value is 62.



**BEAM POWER TUBE**

**6JT6  
6JT6A**

12JT6, 12JT6A,  
17JT6, 17JT6A

Novar types used as horizontal-deflection amplifiers in high-efficiency deflection circuits of black-and-white television receivers employing wide-angle or high-voltage picture tubes. Outlines section, 17C and 31A, respectively; require novar 9-contact socket. Types 12JT6 and 12JT6A and types 17JT6 and 17JT6A are identical with types 6JT6 and 6JT6A except for heater ratings.

	6JT6 6JT6A	12JT6 12JT6A	17JT6 17JT6A	
Heater Voltage (ac/dc)	6.3	12.6	16.8	volts
Heater Current	1.2	0.6	0.45	amperes
Heater Warm-up Time (Average)	—	11	11	seconds
Heater-Cathode Voltage:				
Peak value	±200 max	±200 max	±200 max	volts
Average value	100 max	100 max	100 max	volts
Direct Interelectrode Capacitances:				
Grid No.1 to Plate	—	—	0.26	pF
Grid No.1 to Cathode, Heater, Grid No.2, and Grid No.3	—	—	15	pF
Plate to Cathode, Heater, Grid No.2, and Grid No.3	—	—	6.5	pF

**Class A<sub>1</sub> Amplifier**

CHARACTERISTICS	Pentode Connection		Triode* Connection	
	60	250	150	
Plate Voltage	60	250	150	volts
Grid No.3 (Suppressor Grid)	Connected to cathode at socket			
Grid-No.2 (Screen-Grid) Voltage	150	150	150	volts
Grid-No.1 (Screen-Grid) Voltage	0	-22.5	-22.5	volts
Triode Amplification Factor	—	—	4.4	
Plate Resistance (Approx.)	—	16000	—	ohms
Transconductance	—	7100	—	μmhos
Plate Current	390*	70	—	mA
Grid-No.2 Current	32*	2.1	—	mA
Grid-No.1 Voltage (Approx.) for plate current of 1 mA	—	-42	—	volts

\* Grid No.2 connected to plate.  
 \* This value can be measured by a method involving a recurrent waveform such that the maximum ratings of the tube will not be exceeded.

**Horizontal-Deflection Amplifier**

For operation in a 525-line, 30-frame system

**MAXIMUM RATINGS (Design-Maximum Values)**

DC Plate Supply Voltage .....	770	volts
Peak Positive-Pulse Plate Voltage# .....	8500	volts
Peak Negative-Pulse Plate Voltage .....	-1500	volts
DC Grid-No.3 Voltage .....	70	volts
DC Grid-No.2 Voltage .....	220	volts
DC Grid-No.1 Voltage, Negative-bias value .....	-55	volts
Peak Negative-Pulse Grid-No.1 Voltage .....	-330	volts
Peak Cathode Current .....	550	mA
Average Cathode Current .....	175	mA
Plate Dissipation† .....	17.5	watts
Grid-No.2 Input .....	3.6	watts
Bulb Temperature (At hottest point) .....	240	°C

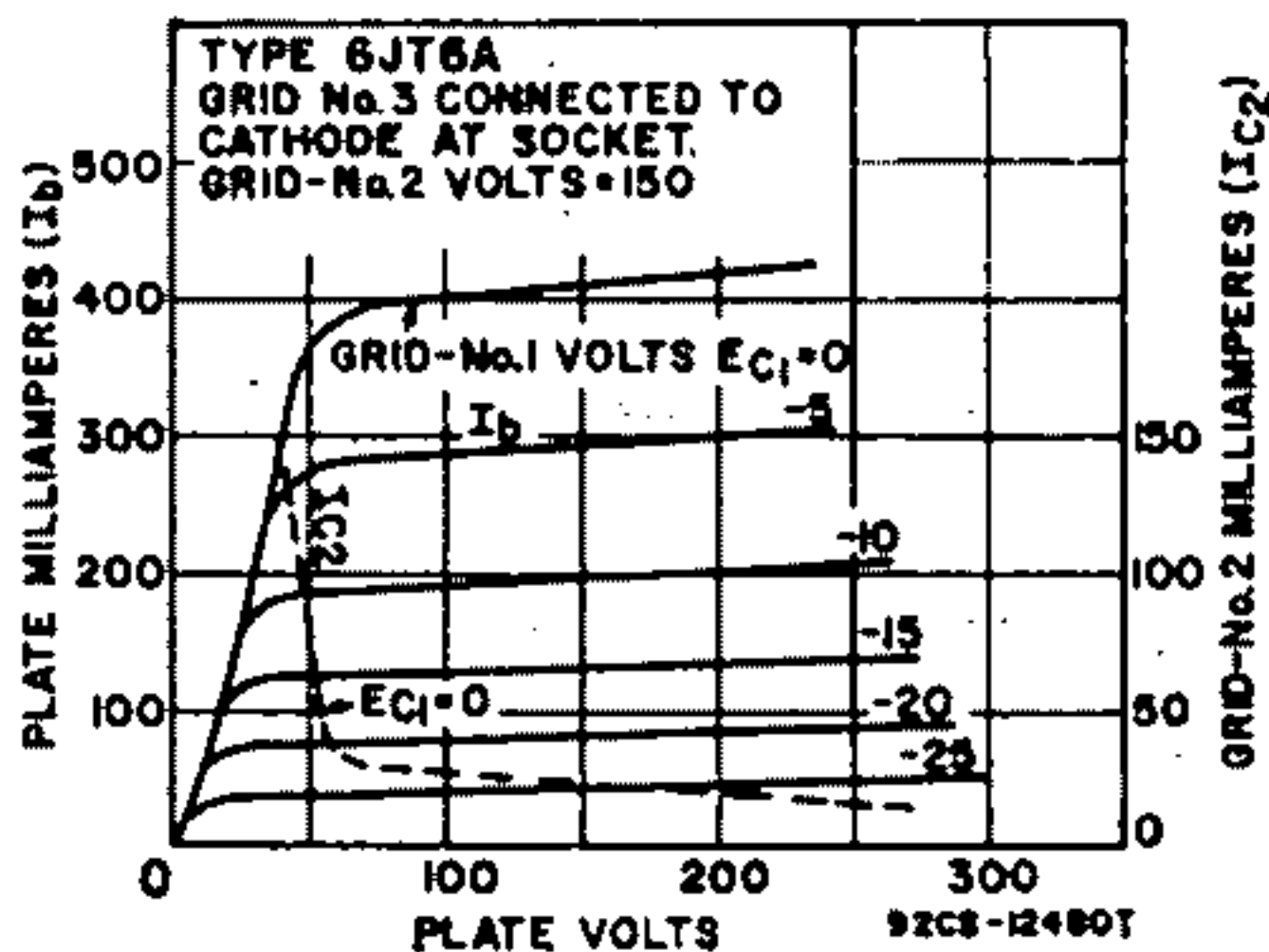
**MAXIMUM CIRCUIT VALUE**

Grid-No.1-Circuit Resistance, for grid-resistor-bias operation ..... 1 megohm

# Pulse duration must not exceed 15% of a horizontal scanning cycle (10 microseconds).

\* A positive voltage may be applied to grid No.3 to reduce interference from "snivets" which may occur in television receivers. A typical value for this voltage is 30 volts.

† A bias resistor or other means is required to protect the tube in absence of excitation.

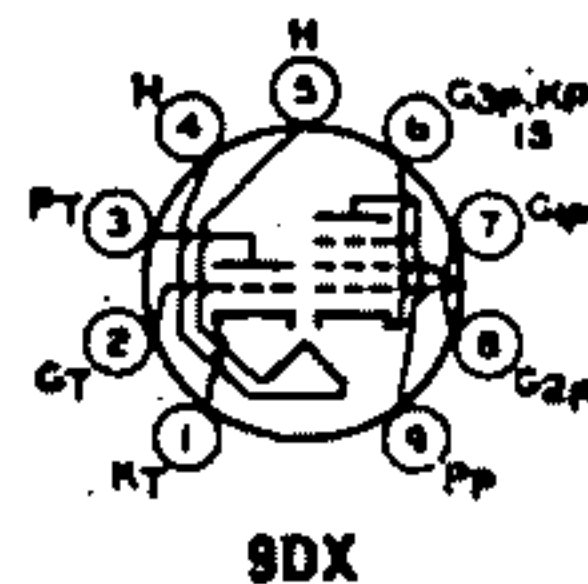


**6JT8**

10JT8

**HIGH-MU TRIODE—  
SHARP-CUTOFF PENTODE**

Miniature type with frame-grid pentode unit used in color and black-and-white television receivers. The triode unit is used as a voltage-amplifier or sync-separator tube, and the pentode unit is used as a video-amplifier tube. Outlines section, 10A, except base is small-button miniature 9-pin; requires miniature 9-contact socket. Type 10JT8 is identical with type 6JT8 except for heater ratings.



Heater Voltage (ac/dc) .....	6JT8	10JT8	
Heater Current .....	6.3	10.2	volts
Heater Warm-up Time (Average) .....	0.725	0.45	ampere
Heater-Cathode Voltage:		11	seconds
Peak value .....	±200 max	±200 max	volts
Average value .....	100 max	100 max	volts

**Class A<sub>1</sub> Amplifier**

**MAXIMUM RATINGS (Design-Maximum Values)**

Plate Voltage .....	Triode Unit	Pentode Unit	
Grid-No.2 (Screen-Grid) Supply Voltage .....	330	330	volts
Grid-No.2 Voltage .....	—	330	volts
Grid-No.1 (Control-Grid) Voltage, Positive-bias value .....	—	See curve page 96	
Plate Dissipation .....	0	0	volts
	1	4	watts



Grid-No.2 Input:				
For grid-No.2 voltages up to 165 volts	—	1.1		watts
For grid-No.2 voltages between 165 and 330 volts	—	See curve page 96		

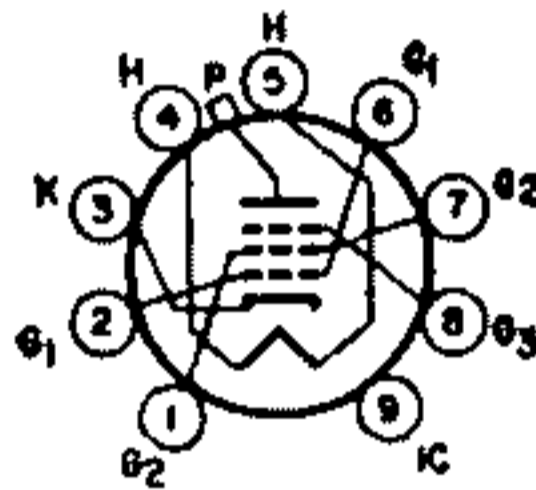
**CHARACTERISTICS**

Plate Supply Voltage	250	50	200	volts
Grid-No.2 Supply Voltage	—	100	100	volts
Grid-No.1 Voltage	—2	0	—	volts
Cathode-Bias Resistor	—	—	82	ohms
Amplification Factor	100	—	—	
Plate Resistance (Approx.)	37000	—	50000	ohms
Transconductance	2700	—	20000	μmhos
Plate Current	1.5	55*	17	mA
Grid-No.2 Current	—	18*	3.5	mA
Grid-No.1 Voltage (Approx.) for plate current of 100 μA	—	—	—5	volts
Grid-No.1 Voltage (Approx.) for plate current of 20 μA	—5.3	—	—	volts

**MAXIMUM CIRCUIT VALUES**

Grid-No.1-Circuit Resistance:				
For fixed-bias operation	0.5	0.25		megohm
For cathode-bias operation	1	1		megohm

\* This value can be measured by a method involving a recurrent waveform such that the maximum ratings of the tube will not be exceeded.



9QL

**BEAM POWER TUBE**

**6JU6**

Novar type used as horizontal-deflection amplifier in color television receivers. Outlines section, 18A; requires novar 9-contact socket.

Heater Voltage (ac/dc)	6.3	volts
Heater Current	1.6	amperes
Heater-Cathode Voltage:		
Peak value	±200 max	volts
Average value	100 max	volts
Direct Interelectrode Capacitances:		
Grid No.1 to Plate	1.2	pF
Grid No.1 to Cathode, Heater, Grid No.2, and Grid No.3	22	pF
Plate to Cathode, Heater, Grid No.2, and Grid No.3	9	pF

**Class A<sub>1</sub> Amplifier**

**CHARACTERISTICS**

	Triode† Connection	Pentode Connection		
	125	50	130	
Plate Voltage	—	—	—	volts
Peak Positive-Pulse Plate Voltage*	—	6500	—	volts
Grid No.3 (Suppressor Grid)	—	Connected to cathode at socket		
Grid-No.2 (Screen-Grid) Voltage	125	125	125	volts
Grid-No.1 (Control-Grid) Voltage	—20	—	—20	volts
Amplification Factor	4.7	—	—	volts
Plate Resistance (Approx.)	—	—	18000	ohms
Transconductance	—	—	7000	μmhos
Plate Current	—	—	470††	mA
Grid-No.2 Current	—	—	82††	mA
Grid-No.1 Voltage for plate current of 1 mA	—	—75	—32	volts

**Horizontal-Deflection Amplifier**

For operation in a 525-line, 30-frame system

**MAXIMUM RATINGS (Design-Maximum Values)**

DC Plate Supply Voltage	770	volts
Peak Positive-Pulse Plate Voltage*	6500	volts
Peak Negative-Pulse Plate Voltage	—1500	volts
DC Grid-No.3 Voltage*	75	volts
DC Grid-No.2 Voltage	220	volts
DC Grid-No.1 Voltage, Negative-bias value	—55	volts
Peak Negative-Pulse Grid-No.1 Voltage	—330	volts
Peak Cathode Current	950	mA
Average Cathode Current	275	mA
Grid-No.2 Input	3.5	watts
Plate Dissipation**	20	watts
Bulb Temperature (At hottest point)	240	°C

**MAXIMUM CIRCUIT VALUES**

Grid-No.1-Circuit Resistance:

For grid-resistor-bias operation .....	0.47	megohms
For plate-pulsed operation .....	10	megohms

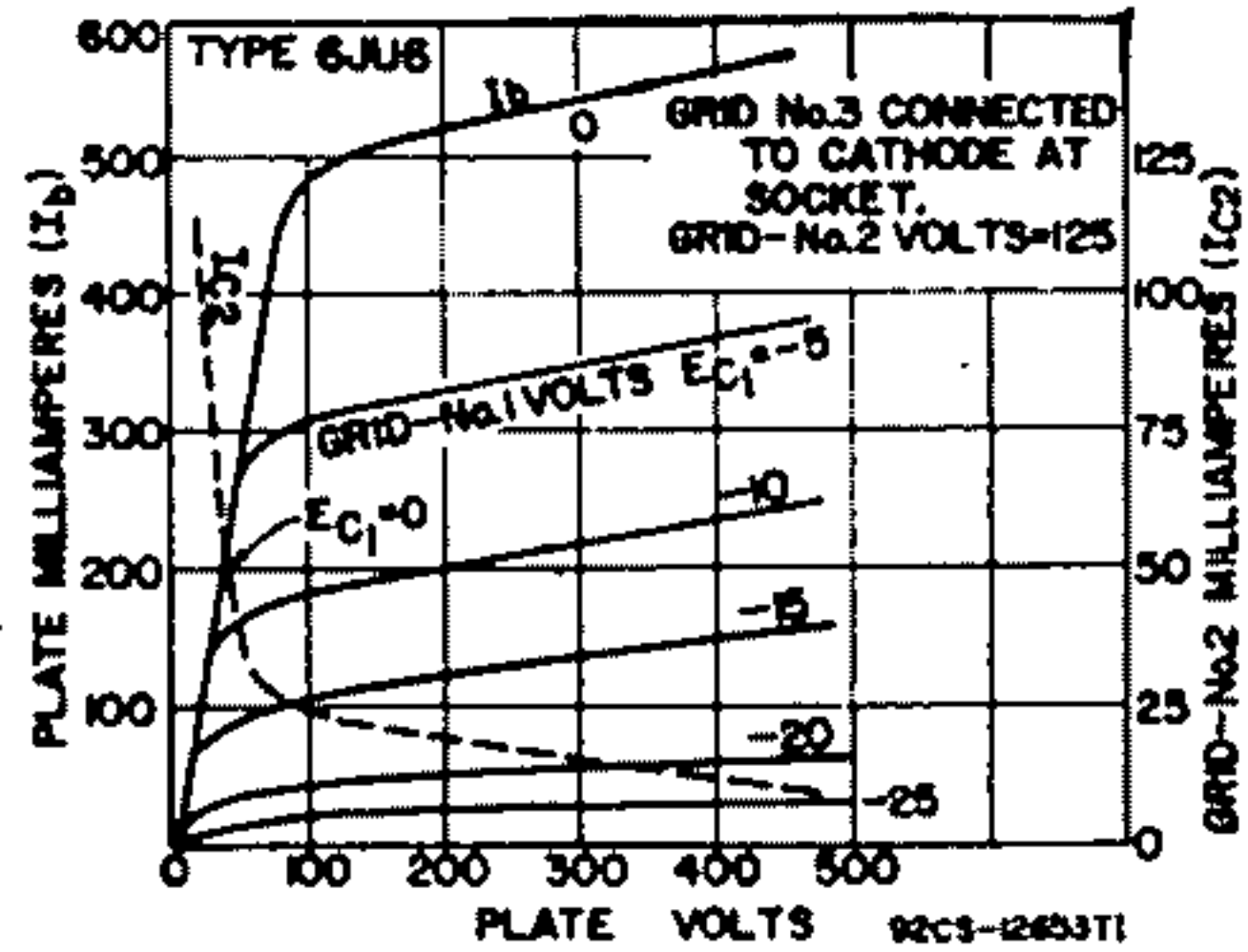
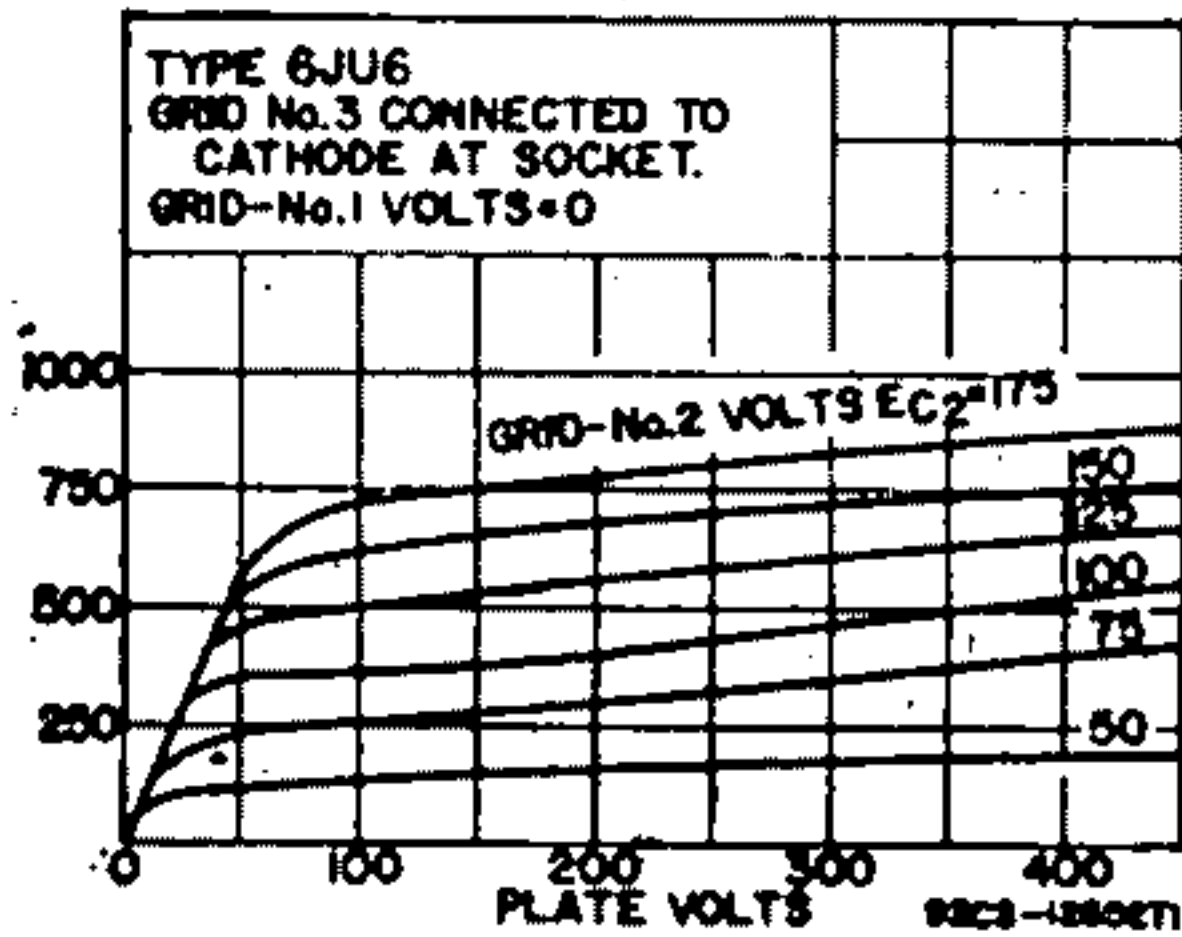
# Pulse duration must not exceed 15% of one horizontal scanning cycle (10 microseconds).

† Grid No.2 connected to plate.

†† This value can be measured by a method involving a recurrent waveform such that the maximum ratings of the tube will not be exceeded.

\* In this service, a positive value may be applied to grid No.3 to minimize "anivets" interference; a typical value for this voltage is 30 volts.

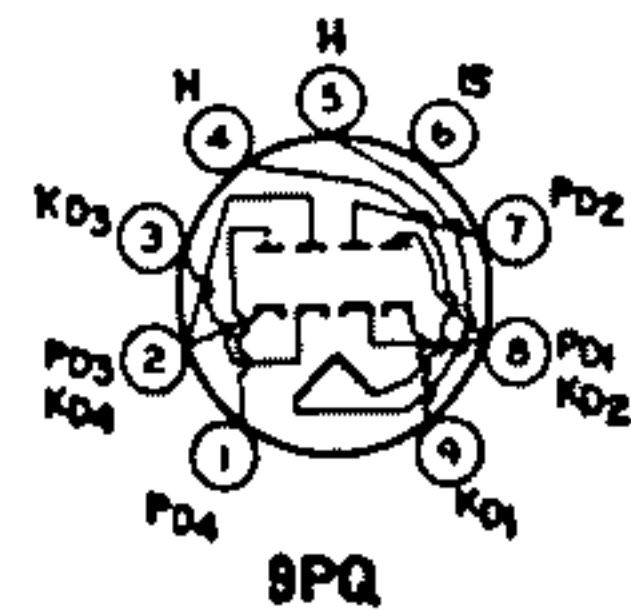
\*\* A bias resistor or other means is required to protect the tube in absence of excitation.



**6JU8  
6JU8A**

**QUADRUPLE DIODE**

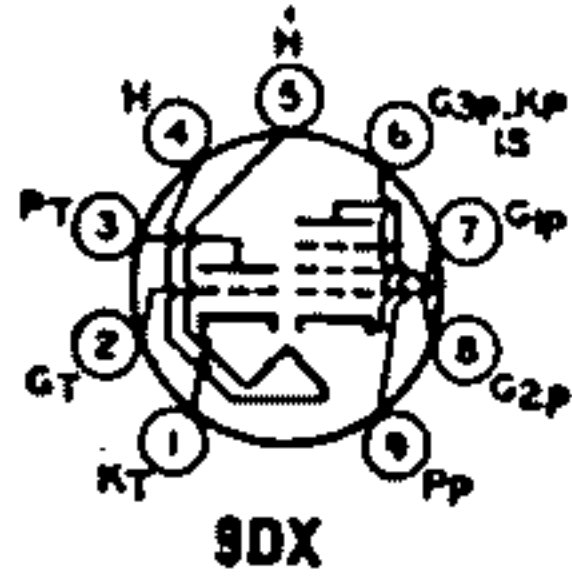
Miniature types used in phase-detector and noise-immune color-killer circuits of color television receivers, and in bridge-matrixing circuits in FM stereo multiplex equipment. Outlines section, 6E and 6B, respectively; require miniature 9-contact socket. Units 1 and 2 are shielded from units 3 and 4 to minimize coupling between the series-connected pairs of diodes.



Heater Voltage (ac/dc) .....	6.8	volts
Heater Current .....	0.6	ampere
Peak Heater-Cathode Voltage .....	±300 max	volts
Direct Interelectrode Capacitances (Approx.):		
Plate of Unit No.1 and Cathode of Unit No.2 to Cathode of Unit No.1 .....	1.8	pF
Plate of Unit No.1 and Cathode of Unit No.2 to Plate of Unit No.2 .....	2.2	pF
Plate of Unit No.2 to Heater and Internal Shield .....	0.62	pF
Plate of Unit No.3 and Cathode of Unit No.4 to Cathode of Unit No.3 .....	1.9	pF
Plate of Unit No.3 and Cathode of Unit No.4 to Plate of Unit No.4 .....	2.2	pF
Plate of Unit No.4 to Heater and Internal Shield .....	0.94	pF
Cathode of Unit No.1 to Heater and Internal Shield .....	1.8	pF
Cathode of Unit No.3 to Heater and Internal Shield .....	1.9	pF
<b>MAXIMUM RATINGS (Design-Center Values, Each Diode Unit)</b>		
Peak Inverse Plate Voltage .....	300	volts
Peak Plate Current .....	64	volts
Average Output Current .....	9	mA
<b>CHARACTERISTICS, Instantaneous Value (Each Unit)</b>		
Plate Current for plate voltage of 10 volts .....	60	mA

**HIGH-MU TRIODE—  
SHARP-CUTOFF PENTODE**

**6JV8**  
8JV8

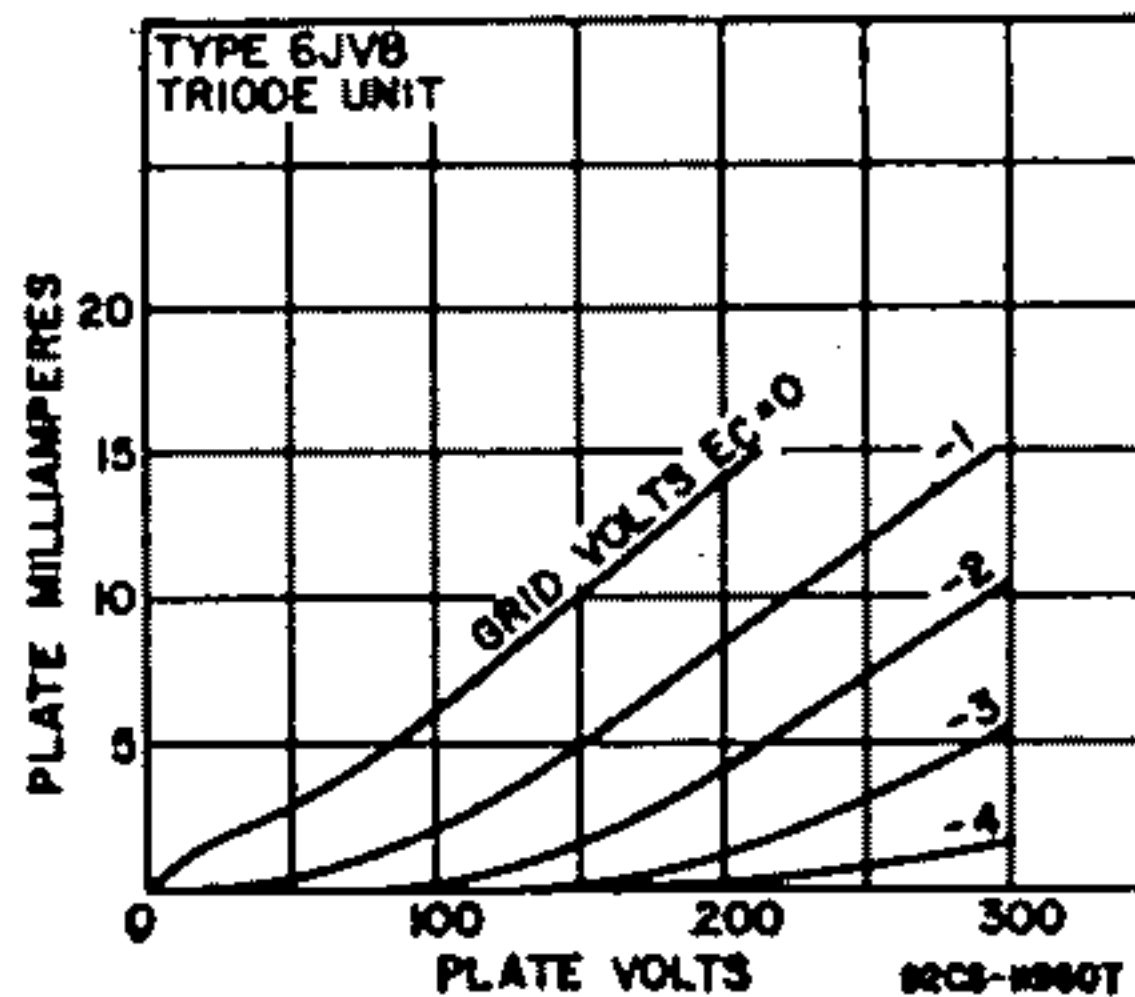


Miniature type used in television receiver applications, particularly those having low-voltage "B" supplies. The triode unit is used in sound-if, keyed-agc, sync-separator, sync-amplifier, and noise-suppression circuits. The pentode unit is especially useful as a video amplifier tube. Outlines section, 6E; requires miniature 9-contact socket. Type 8JV8 is identical with type 6JV8 except for heater ratings.

	6JV8	8JV8	
Heater Voltage (ac/dc)	6.8	8.5	volts
Heater Current	0.6	0.45	ampere
Heater Warm-up Time (Average)	11	11	seconds
<b>Heater-Cathode Voltage:</b>			
Peak value	±200 max	±200 max	volts
Average value	100 max	100 max	volts
<b>Direct Interelectrode Capacitances (Approx.):</b>			
<b>Triode Unit:</b>			
Grid to Plate		2.2	pF
Grid to Cathode and Heater		3	pF
Plate to Cathode and Heater		2	pF
<b>Pentode Unit:</b>			
Grid No.1 to Plate		0.08 max	pF
Grid No.1 to Cathode, Heater, Grid No.2, Grid No.3, and Internal Shield		8	pF
Plate to Cathode, Heater, Grid No.2, Grid No.3, and Internal Shield		3.2	pF
Pentode Grid No.1 to Triode Plate		0.012 max	pF
Pentode Plate to Triode Plate		0.24 max	pF

**Class A<sub>1</sub> Amplifier**

<b>MAXIMUM RATINGS (Design-Maximum Values)</b>		Triode Unit	Pentode Unit		
Plate Voltage		330	330	volts	
Grid-No.2 (Screen-Grid) Voltage		—	330	volts	
Grid-No.1 (Control-Grid) Voltage:					
Positive-bias value		0	0	volts	
Negative-bias value		-50	-50	volts	
Plate Dissipation		1.1	4	watts	
Grid-No.2 Input		—	1.7	watts	
<b>CHARACTERISTICS</b>		<b>Triode Unit</b>	<b>Pentode Unit</b>		
Plate Voltage	200	60	125	200	volts
Grid-No.2 Voltage	—	200	125	200	volts
Grid-No.1 Voltage	-2	0	-1	-2.9	volts
Amplification Factor	70	—	—	—	
Plate Resistance (Approx.)	0.0175	—	0.1	0.15	megohm
Transconductance	4000	—	11500	10700	μmhos
Plate Current	4	51*	22	22	mA
Grid-No.2 Current	—	14*	4	4	mA
Grid-No.1 Voltage (Approx.) for plate current of 20 μA	-5	—	-5.5	-9	volts





**MAXIMUM CIRCUIT VALUES**

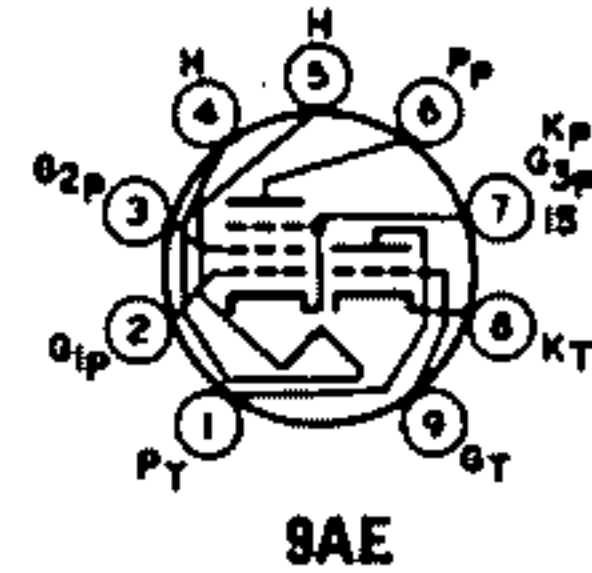
Grid-No.1-Circuit Resistance:			
For fixed-bias operation .....	0.5	0.25	megohm
For cathode-bias operation .....	1	1	megohm

\* This value can be measured by a method involving a recurrent waveform such that the maximum ratings of the tube will not be exceeded.

**6JW8/  
ECF802**  
6LX8/LCF802

**MEDIUM-MU TRIODE—  
SHARP-CUTOFF PENTODE**

Miniature type used as horizontal-oscillator and frequency-control tube in color and black-and-white television receivers. Outlines section, 6B; requires miniature 9-contact socket. Type 6LX8/LCF802 is identical with type 6JW8/ECF802 except for heater ratings.



	<b>6JW8/ ECF802</b>	<b>6LX8/ LCF802</b>	
Heater Voltage (ac/dc) .....	6.3	6.0	volts
Heater Current .....	0.43	0.46	ampere
Heater-Cathode Voltage:			
Peak value .....	±200 max	±200 max	volts
Average value .....	100 max	100 max	volts

**Class A<sub>1</sub> Amplifier**

**MAXIMUM RATINGS (Design-Maximum Values)**

	<b>Triode Unit</b>	<b>Pentode Unit</b>	
Plate Supply Voltage .....	550	550	volts
Plate Voltage .....	250	250	volts
Grid-No.2 (Screen-Grid) Supply Voltage .....	—	550	volts
Grid-No.2 Voltage .....	—	250	volts
Peak Cathode Current* .....	—	50	mA
Cathode Current .....	10	15	mA
Plate Dissipation .....	1.4	1.2	watts
Grid-No.2 Input .....	—	0.8	watts
Input Impedance at 60 cycles .....	50	300	kohms

**CHARACTERISTICS**

Plate Voltage .....	200	100	volts
Grid-No.2 Voltage .....	—	100	volts
Grid-No.1 (Control-Grid) Voltage .....	—2	—1	volts
Mu Factor, Grid-No.1 to Grid-No.2 .....	—	47	
Amplification Factor .....	70	—	
Input Resistance .....	0.2	0.4	megohm
Transconductance .....	8500	6500	μmhos
Plate Current .....	3.5	6	mA
Grid-No.2 Current .....	—	1.7	mA
Plate Current:			
For grid-No.1 voltage of 0 volts .....	—	12.5	mA
For grid current of 10 μA .....	10	—	mA
Grid-No.2 Current for grid-No.1 voltage of 0 volts ..	—	3.5	mA
Grid-No.1 Voltage:			
For grid-No.1 current of +0.3 μA .....	—1.3	—1.3	volts
For plate and grid-No.2 voltage of 200 volts and plate current of 10 μA .....	—	—16	volts

**MAXIMUM CIRCUIT VALUES**

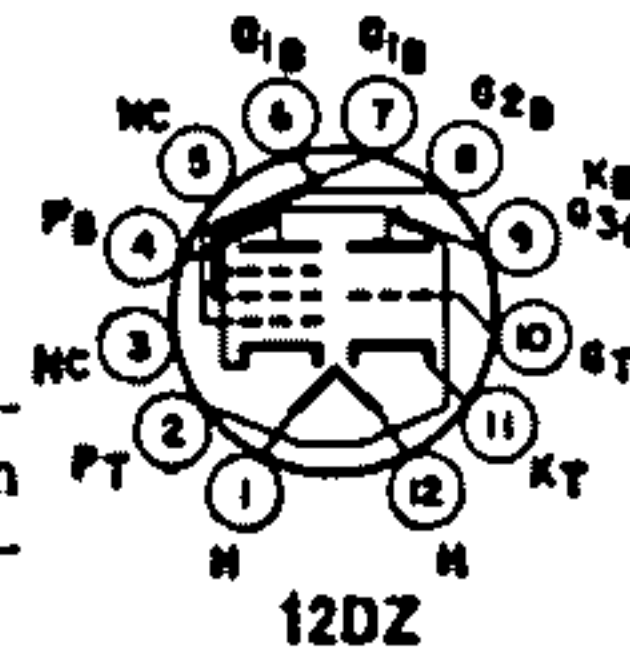
Grid-No.1-Circuit Resistance:			
For fixed-bias operation .....	—	0.56	megohm
For cathode-bias operation .....	8	1.0	megohms

\* With a maximum duty factor of 0.30 and maximum pulse duration of 30 microseconds.

**6JZ8**  
17JZ8

**MEDIUM-MU TRIODE—  
BEAM POWER TUBE**

Duodecar type used in combined vertical-deflection-oscillator and vertical-deflection-amplifier applications in television receivers. Outlines section, 8C; requires duodecar 12-contact socket.



	6JZ8	17JZ8	
Heater Voltage (ac/dc) .....	6.3	16.8	volts
Heater Current .....	1.2	0.45	amperes
Heater Warm-up Time .....	—	11	seconds
Heater-Cathode Voltage:			
Peak value .....	±200 max	±200 max	volts
Average value .....	100 max	100 max	volts

**Class A<sub>1</sub> Amplifier**

<b>CHARACTERISTICS</b>	Triode Unit	Beam Power Unit	
Plate Voltage .....	150	45	120
Grid-No.2 (Screen-Grid) Voltage .....	—	110	110
Grid-No.1 (Control-Grid) Voltage .....	—5	0	—8
Amplification Factor .....	20	—	—
Plate Resistance (Approx.) .....	8500	—	11700
Transconductance .....	2350	—	7100
Plate Current .....	5.5	122*	46
Grid-No.2 Current .....	—	18.6*	3.5
Grid-No.1 Voltage (Approx.) for plate current of 10 $\mu$ A .....	—10	—	—
Grid-No.1 Voltage (Approx.) for plate current of 100 $\mu$ A .....	—	—	—25

\* This value can be measured by a method involving a recurrent waveform such that the maximum ratings of the tube will not be exceeded.

**Vertical-Deflection Oscillator and Amplifier**

For operation in a 525-line, 30-frame system

	Triode Unit	Beam Power Unit	
	Oscillator	Amplifier	
<b>MAXIMUM RATINGS (Design-Maximum Values)</b>			
DC Plate Voltage .....	250	250	volts
Peak Positive-Pulse Plate Voltage# .....	—	2000	volts
DC Grid-No.2 Voltage .....	—	200	volts
Peak Negative-Pulse Grid-No.1 Voltage .....	—400	—150	volts
Peak Cathode Current .....	70	245	mA
Average Cathode Current .....	20	70	mA
Plate Dissipation* .....	1	7	watts
Grid-No.2 Input .....	—	1.8	watts

**MAXIMUM CIRCUIT VALUES**

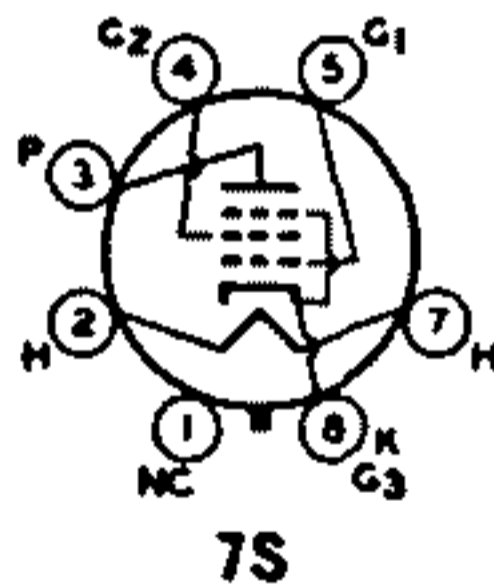
Grid-No.1-Circuit Resistance:			
For fixed-bias operation .....	1	1	megohm
For cathode-bias operation .....	2.2	2.2	megohms

# Pulse duration must not exceed 15% of a vertical scanning cycle (2.5 milliseconds).

\* A bias resistor or other means is required to protect the tube in absence of excitation.

Refer to chart at end of section.

**6K5GT**



**POWER PENTODE**

**6K6GT**

Glass octal type used in output stage of radio receivers and, triode-connected, as a vertical-deflection amplifier in television receivers. This type may be supplied with pin No.1 omitted. Outlines section, 13D; requires octal socket. This tube, like other power-handling tubes, should be adequately ventilated.

Heater Voltage (ac/dc) .....	6.3	volts
Heater Current .....	0.4	ampere
Heater-Cathode Voltage:		
Peak value .....	±200 max	volts
Average value .....	100 max	volts
Direct Interelectrode Capacitances (Approx.):		
Grid No.1 to Plate .....	0.5	pF
Grid No.1 to Cathode, Heater, Grid No.2, and Grid No.3 .....	5.5	pF
Plate to Cathode, Heater, Grid No.2, and Grid No.3 .....	6.0	pF

**Class A<sub>1</sub> Amplifier**

<b>MAXIMUM RATING (Design-Center Values)</b>		
Plate Voltage .....	315	volts
Grid-No.2 (Screen-Grid) Voltage .....	235	volts
Plate Dissipation .....	8.5	watts
Grid-No.2 Input .....	2.8	watts

**TYPICAL OPERATION**

Plate Voltage .....	100	250	315	volts
Grid-No.2 Voltage .....	100	250	250	volts
Grid-No.1 (Control-Grid) Voltage .....	-7	-18	-21	volts
Peak AF Grid-No.1 Voltage .....	7	18	21	volts
Zero-Signal Plate Current .....	9	82	25.5	mA
Maximum-Signal Plate Current .....	9.5	33	28	mA
Zero-Signal Grid-No.2 Current .....	1.6	5.5	4.0	mA
Maximum-Signal Grid-No.2 Current .....	8	10	9	mA
Plate Resistance (Approx.) .....	104000	90000	110000	ohms
Transconductance .....	1500	2300	2100	μmhos
Load Resistance .....	12000	7500	9000	ohms
Total Harmonic Distortion .....	11	11	15	per cent
Maximum-Signal Power Output .....	0.35	3.4	4.5	watts

**TYPICAL PUSH-PULL OPERATION (Values are for two tubes)**

	Fixed Bias	Cathode Bias	
Plate Supply Voltage .....	285	285	volts
Grid-No.2 Supply Voltage .....	285	285	volts
Grid-No.1 Voltage .....	-25.5	—	volts
Cathode-Bias Resistor .....	—	400	ohms
Peak AF Grid-No.1-to-Grid-No.1 Voltage .....	51	51	volts
Zero-Signal Plate Current .....	55	55	mA
Maximum-Signal Plate Current .....	72	61	mA
Zero-Signal Grid-No.2 Current .....	9	9	mA
Maximum-Signal Grid-No.2 Current .....	17	13	mA
Effective Load Resistance (Plate-to-plate) .....	12000	12000	ohms
Total Harmonic Distortion .....	6	4	per cent
Maximum-Signal Power Output .....	10.5	9.8	watts

**CHARACTERISTICS (Triode Connection)\***

Plate Voltage .....	250	volts
Grid-No.1 Voltage .....	-18	volts
Plate Current .....	37.5	mA
Transconductance .....	2700	μmhos
Amplification Factor .....	6.8	
Plate Resistance (Approx.) .....	2500	ohms
Grid-No.1 Voltage (Approx.) for plate current of 0.5 mA .....	-48	volts

**MAXIMUM CIRCUIT VALUES**

Grid-No.1-Circuit Resistance:		
For fixed-bias operation .....	0.1	megohm
For cathode-bias operation .....	0.3	megohm

\* Grid-No.2 connected to plate.

**Vertical Deflection Amplifier (Triode Connection)\***

For operation in a 525-line, 30-frame system

**MAXIMUM RATINGS**

DC Plate Voltage .....	315	volts
Peak Positive-Pulse Plate Voltage* (Absolute maximum) .....	1200*	volts
Peak Negative-Pulse Grid-No.1 Voltage .....	-250	volts
Peak Cathode Current .....	75	mA
Average Cathode Current .....	25	mA
Plate Dissipation .....	7	watts

**MAXIMUM CIRCUIT VALUE**

Grid-No.1-Circuit Resistance, for cathode-bias operation .....	2.2	megohms
--	-----	---------

\* Grid No.2 connected to plate.

# Pulse duration must not exceed 15% of a vertical scanning cycle (2.5 milliseconds).

\* Under no circumstances should this absolute value be exceeded.

**6K7**  
**6K7G**  
**6K7GT**

Refer to chart at end of section.

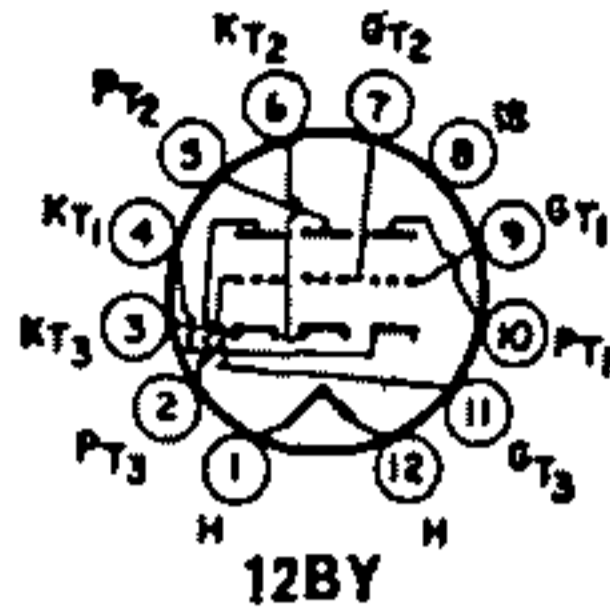
**6K8**  
**6K8G**  
**6K8GT**

Refer to chart at end of section.

**6K11**

Refer to chart at end of section.





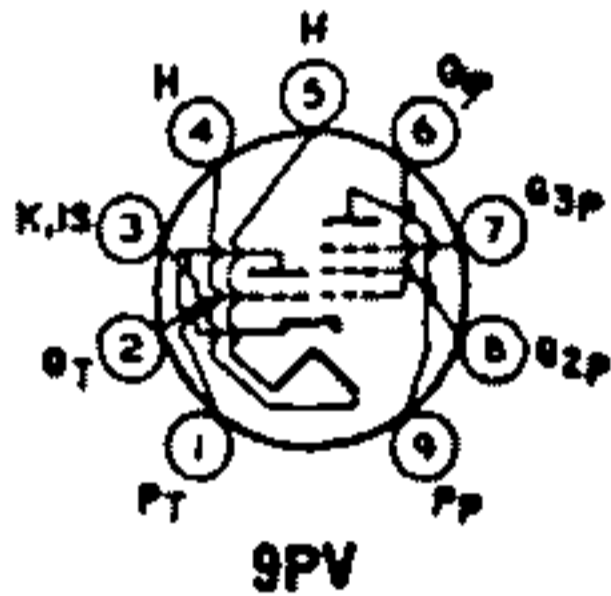
**THREE-UNIT TRIODE**

**6K11/  
6Q11**

Duodecar type used as combined agc, sync, and noise-inverter tube in television receivers. Outlines section, 8A; requires duodecar 12-contact socket. Heater: volts (ac/dc), 6.3 amperes, 0.6; warm-up time (average), 11 seconds; maximum heater-cathode volts,  $\pm 200$  peak, 100 average.

**Class A<sub>1</sub> Amplifier**

MAXIMUM RATINGS (Design-Maximum Values)	Unit No.1	Units Nos.2 and 3	
Plate Voltage	330	330	volts
Grid Voltage:			
Negative-bias value	-50	-50	volts
Positive-bias value	0	0	volts
Cathode Current	20	—	mA
Plate Dissipation	2.75	0.3	watts
<b>CHARACTERISTICS</b>			
Plate Voltage	250	250	volts
Grid Voltage	-8.5	-2	volts
Amplification Factor	17	100	
Plate Resistance (Approx.)	7700	62500	ohms
Transconductance	2200	1600	amhos
Plate Current	10.6	1.2	mA
Grid Voltage (Approx.) for plate current of 10 $\mu$ A	-24	—	volts



**HIGH-MU TRIODE—  
SHARP-CUTOFF PENTODE**

**6KA8  
8KA8**

Miniature type used in color and black-and-white television receivers. The triode unit is used in sync-separator circuits; the pentode unit has two independent control grids and is used in gated-agc-amplifier and noise-inverter circuits. Outlines section, 6E; requires miniature 9-contact socket. For curves of average plate characteristics for triode unit, refer to type 6AW8A. Type 8KA8 is identical with type 6KA8 except for heater ratings.

	6KA8	8KA8	
Heater Voltage (ac/dc)	6.3	8.4	volts
Heater Current	0.6	0.45	ampere
Heater Warm-up Time (Average)	11	11	seconds
Heater-Cathode Voltage:			
Peak value	$\pm 200$ max	$\pm 200$ max	volts
Average value	100 max	100 max	volts
Direct Interelectrode Capacitances:			
Triode Unit:			
Grid to Plate		2.2	pF
Grid to Cathode, Heater, and Internal Shield		2.8	pF
Plate to Cathode, Heater, and Internal Shield		2.2	pF
Pentode Unit:			
Grid-No.1 to Plate		0.1 max	pF
Grid No.1 to Cathode, Heater, Grid No.2, Grid No.3, and Internal Shield		9.5	pF
Grid No.1 to Grid No.3		0.5	pF
Grid No.3 to Plate		2.2	pF
Grid No.3 to All Other Electrodes, Heater, and Internal Shield		7	pF

**Class A<sub>1</sub> Amplifier**

MAXIMUM RATINGS (Design-Maximum Values)	Triode Unit	
Plate Voltage	300	volts
Grid Voltage:		
Positive-bias value	0	volts
Negative-bias value	-50	volts
Plate Dissipation	1.1	watts

**CHARACTERISTICS**

	Triode Unit	Pentode Unit	
Plate Supply Voltage	200	150	volts
Grid-No.3 Supply Voltage	—	0	volts
Grid-No.2 Supply Voltage	—	100	volts
Grid-No.1 Supply Voltage	-2	0	volts
Cathode-Bias Resistor	—	180	ohms
Amplification Factor	70	—	
Plate Resistance (Approx.)	17500	100000	ohms
Transconductance, Grid No.1 to Plate	4000	4400	μmhos
Transconductance, Grid No.3 to Plate	—	600	μmhos
Plate Current	4	4	mA
Grid-No.2 Current	—	2.8	mA
Grid-No.1 Supply Voltage (Approx.):			
For plate current of 10 μA	-5	—	volts
For plate current of 20 μA	—	-4	volts
Grid No.3 Supply Voltage (Approx.) for plate current of 20 μA	—	-7	volts

**MAXIMUM CIRCUIT VALUES**

	Triode Unit	
Grid-Circuit Resistance:		
For fixed-bias operation	0.25	megohm
For cathode-bias operation	1	megohm

**Gated AGC Amplifier and Noise Inverter**

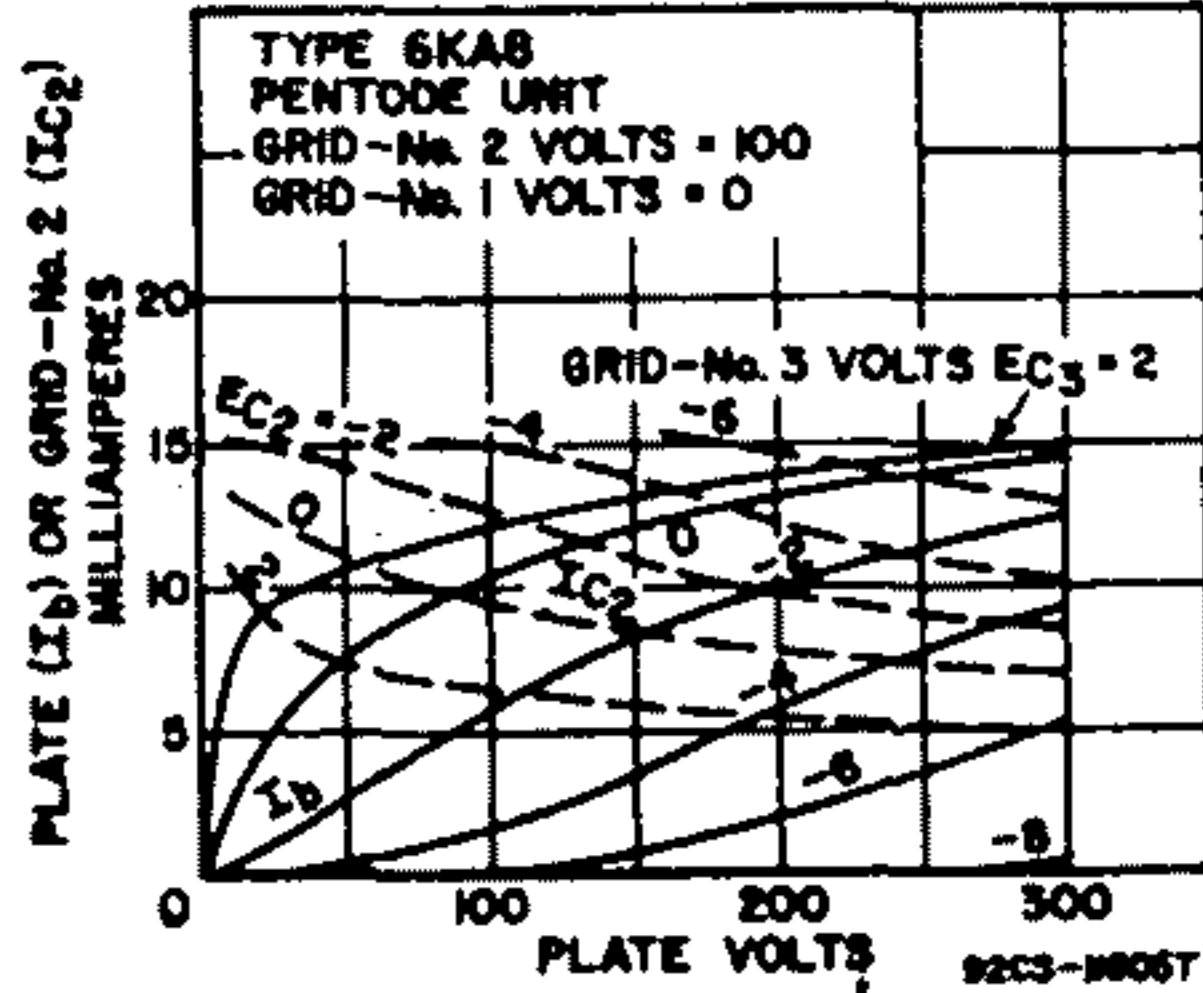
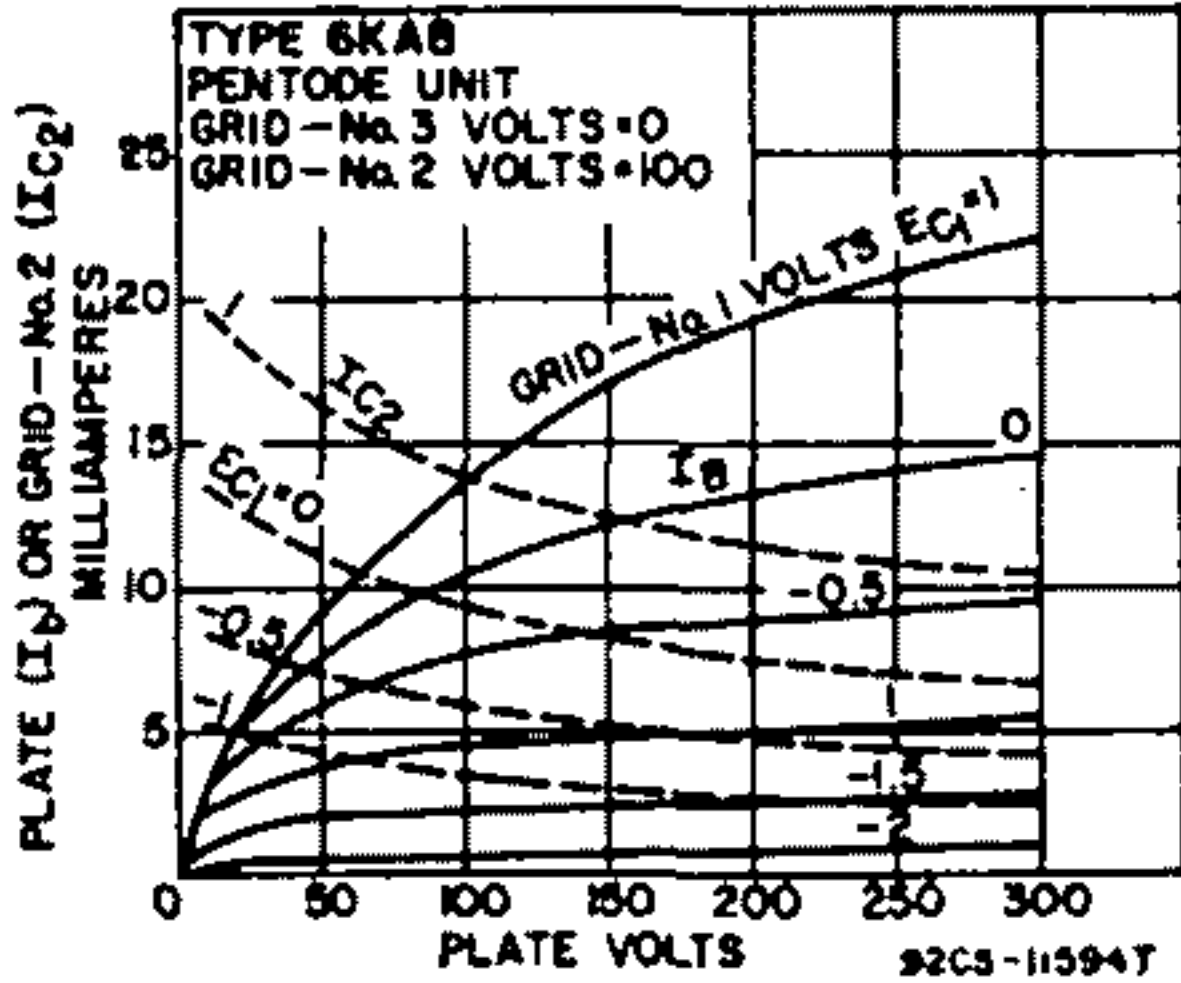
**MAXIMUM RATINGS (Design-Maximum Values)**

	Pentode Unit	
DC Plate Voltage	300	volts
Peak Positive-Pulse Plate Voltage*	600	volts
Grid-No.3 (Control-Grid) Voltage:		
Positive-bias value	0	volts
Negative-bias value	-100	volts
Grid-No.2 (Screen-Grid) Supply Voltage	300	volts
Grid-No.2 Voltage	See curve page 96	
Grid-No.1 (Control-Grid) Voltage:		
Positive-bias value	0	volts
Negative-bias value	-50	volts
Plate Dissipation	2	watts
Grid-No.2 Input:		
For grid-No.2 voltages up to 150 volts	1.1	watts
For grid-No.2 voltages between 150 and 300 volts	See curve page 96	

**MAXIMUM CIRCUIT VALUES**

Grid-No.3-Circuit Resistance	0.68	megohm
Grid-No.1-Circuit Resistance:		
For fixed-bias operation	0.5	megohm
For cathode-bias operation	1	megohm

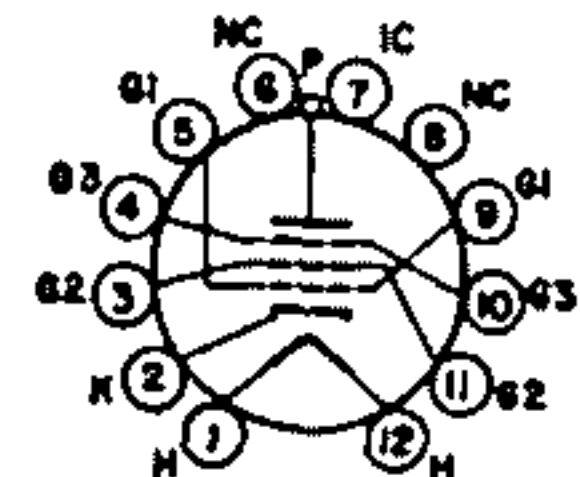
\* Pulse duration must not exceed 15% of a horizontal scanning cycle (10 microseconds).



**6KD6**

**BEAM POWER TUBE**

Duodecar type used as horizontal-deflection amplifier in television receivers. Outlines section, 16C; requires duodecar 12-contact socket. Heater: volts (ac/dc), 6.3; amperes, 2.85; maximum heater-cathode volts, ±200 peak, 100 average.



12GW

**Horizontal-Deflection Amplifier**

For operation in a 525-line, 30-frame system

**MAXIMUM RATINGS (Design-Maximum Values)**

DC Plate Supply Voltage	990	volts
Peak Positive-Pulse Plate Voltage†	7000	volts
Positive DC Grid-No.3 Voltage	70	volts
Grid-No.2 Voltage	200	volts
Peak Negative-Pulse Grid-No.1 Voltage	-250	volts
Peak Cathode Current	1400	mA
Average Cathode Current	400	mA
Plate Dissipation*	33	watts
Grid-No.2 Input	5	watts
Bulb Temperature (At hottest point)	225	°C

**Class A<sub>1</sub> Amplifier**

**CHARACTERISTICS**

	Triode† Connection	Pentode Connection		
	160	60	150	volts
Plate Voltage		Connected to cathode at socket		
Grid No.3 (Suppressor Grid)		110	110	volts
Grid-No.2 (Screen-Grid) Voltage	150	0	-22.5	volts
Grid-No.1 (Control-Grid) Voltage	-22.5			
Amplification Factor	4			
Plate Resistance (Approx.)			6000	ohms
Transconductance			14000	μmhos
Plate Current		750**	120	mA
Grid-No.2 Current		42**	1.8	mA
Grid-No.1 Voltage (Approx.) for plate current of 1.0 μA			-40	volts

**MAXIMUM CIRCUIT VALUE**

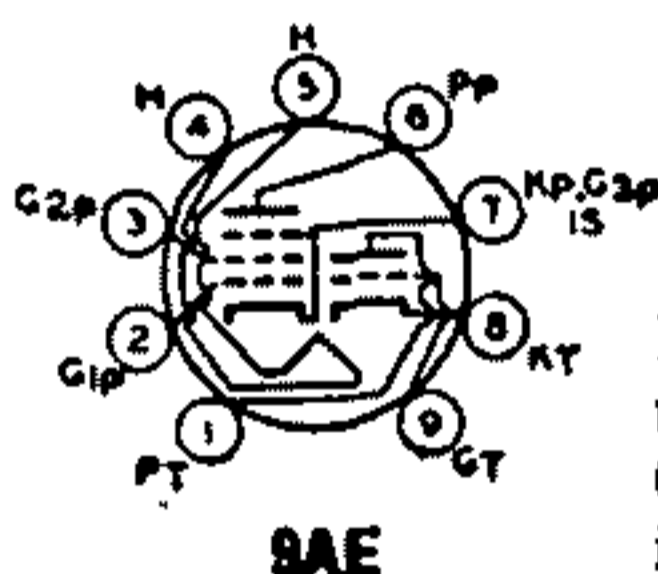
Grid-No.1-Circuit Resistance	2.2	megohms
------------------------------	-----	---------

\* A bias resistor or other means is required to protect the tube in absence of excitation.

† Pulse duration must not exceed 15% of a horizontal scanning cycle (10 microseconds).

‡ Grid-No.2 connected to plate at socket.

\*\* This value can be measured by a method involving a recurrent waveform such that the maximum ratings of the tube will not be exceeded.



**MEDIUM-MU TRIODE—  
SHARP-CUTOFF PENTODE**

**6KD8  
5KD8**

Miniature type used as combined vhf oscillator and mixer tube in television receivers. Outlines section, 6B; requires miniature 9-contact socket. Type 5KD8 is identical with type 6KD8 except for heater ratings.

	5KD8	6KD8	
Heater Voltage (ac/dc)	6.6	6.8	volts
Heater Current	0.45	0.4	ampere
Heater Warm-up Time	11	—	seconds
Heater-Cathode Voltage:			
Peak value	±200 max	±200 max	volts
Average value	100 max	100 max	volts

**Class A<sub>1</sub> Amplifier**

**MAXIMUM RATINGS (Design-Maximum Values)**

	Triode Unit	Pentode Unit	
Plate Voltage	330	330	volts
Grid-No.2 (Screen-Grid) Supply Voltage	—	330	volts
Grid-No.2 Voltage	—	See curve page 96	
Grid-No.1 (Control-Grid) Voltage, Positive-bias value	0	0	volts
Plate Dissipation	2.5	3	watts
Grid-No.2 Input:			
For grid-No.2 voltages up to 165 volts	—	0.55	watt
For grid-No.2 voltages between 165 and 330 volts	—	See curve page 96	

**CHARACTERISTICS**

	Triode Unit	Pentode Unit	
Plate Voltage	125	125	volts
Grid-No.2 Voltage	—	110	volts
Grid-No.1 Voltage	-1	-1	volt
Amplification Factor	40	—	
Plate Resistance (Approx.)	—	0.2	megohm
Transconductance	7500	5000	μmhos
Plate Current	13.5	9.5	mA



Grid-No.2 Current .....	—	3.5	mA
Grid-No.1 Voltage (Approx.) for plate current of 20 $\mu$ A .....	—9	—8	volts

**MAXIMUM CIRCUIT VALUES**

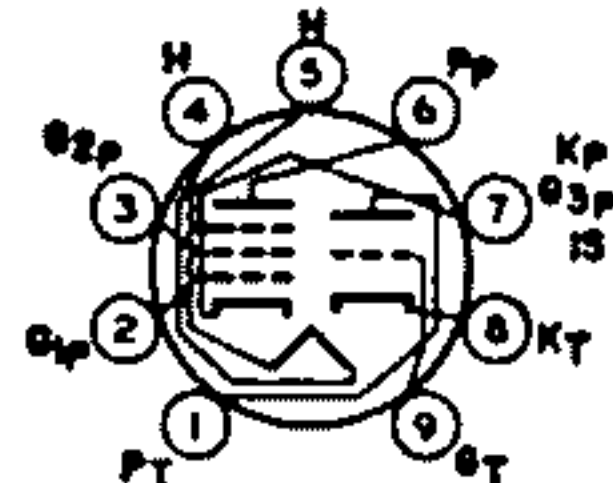
Grid-No.1-Circuit Resistance:			
For fixed-bias operation .....		0.5	megohm
For cathode-bias operation .....		1	megohm

**6KE8**

4KE8, 5KE8

**MEDIUM-MU TRIODE—  
SHARP-CUTOFF PENTODE**

Miniature type with frame-grid pentode unit used as combined oscillator-mixer tube in television receivers using an intermediate frequency in the order of 40 MHz. Outlines section, 6B; requires miniature 9-contact socket. Types 4KE8 and 5KE8 are identical with type 6KE8 except for heater ratings.



9DC

Heater Voltage (ac/dc) .....	4KE8	5KE8	6KE8	
Heater Current .....	4.5	5.6	6.3	volts
Heater Warm-up Time (Average) .....	0.6	0.45	0.4	ampere
Heater-Cathode Voltage:				seconds
Peak value .....	$\pm 200$ max	$\pm 200$ max	$\pm 200$ max	volts
Average value .....	100	100 max	100 max	volts
Direct Interelectrode Capacitances:†				
Triode Unit:				
Grid to Plate .....			1.8	pF
Grid to Cathode, Heater, Pentode Cathode, Pentode Grid No.3, and Internal Shield .....			2.4	pF
Plate to Cathode, Heater, Pentode Cathode, Pentode Grid No.3, and Internal Shield .....			2	pF
Pentode Unit:				
Grid No.1 to Plate .....			0.015 max	pF
Grid No.1 to Cathode, Heater, Grid No.2, Grid No.3, and Internal Shield .....			5	pF
Plate to Cathode, Heater, Grid No.2, Grid No.3, and Internal Shield .....			3.4	pF
Heater to Triode Cathode and Pentode Cathode .....			5.5*	pF

† With external shield connected to cathode of unit under test, except as noted.

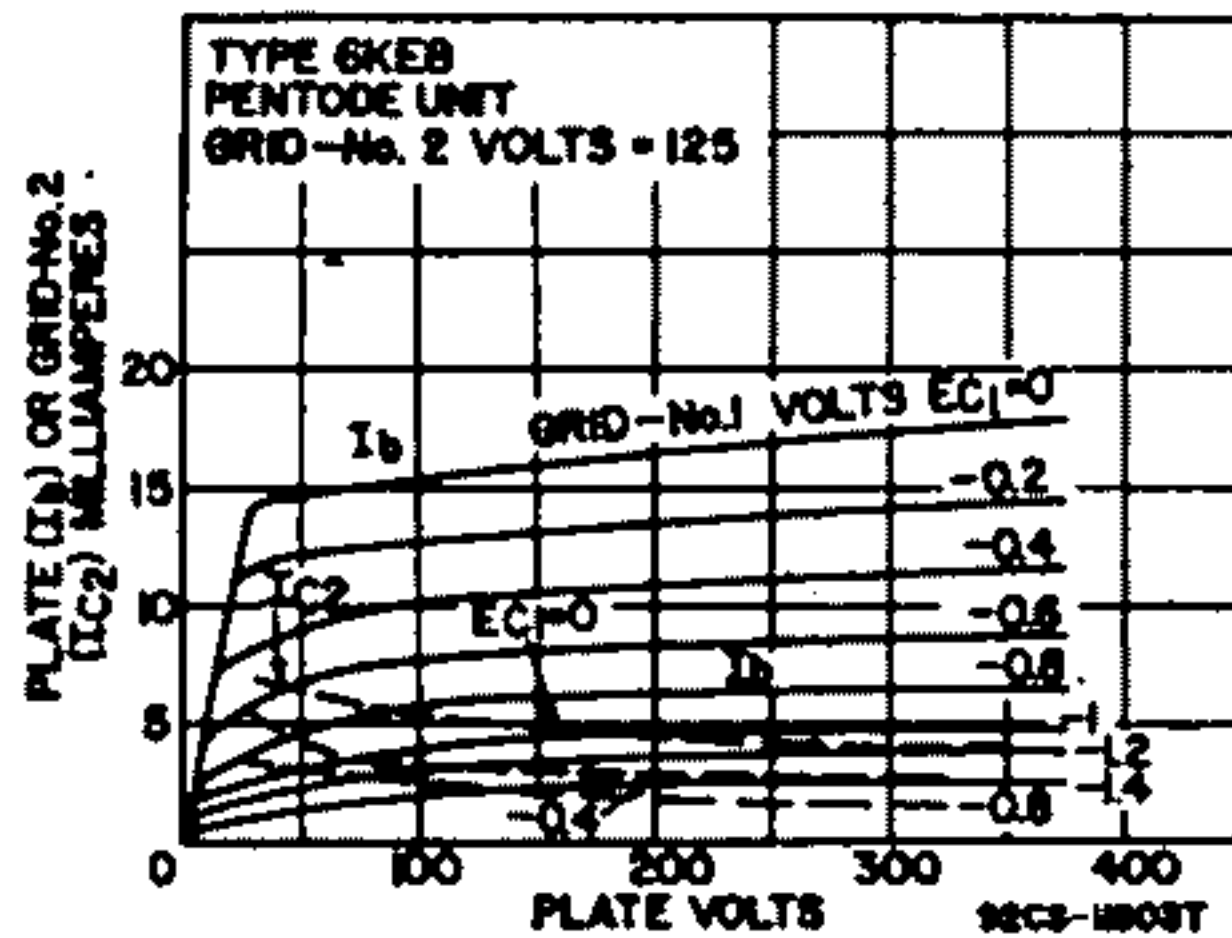
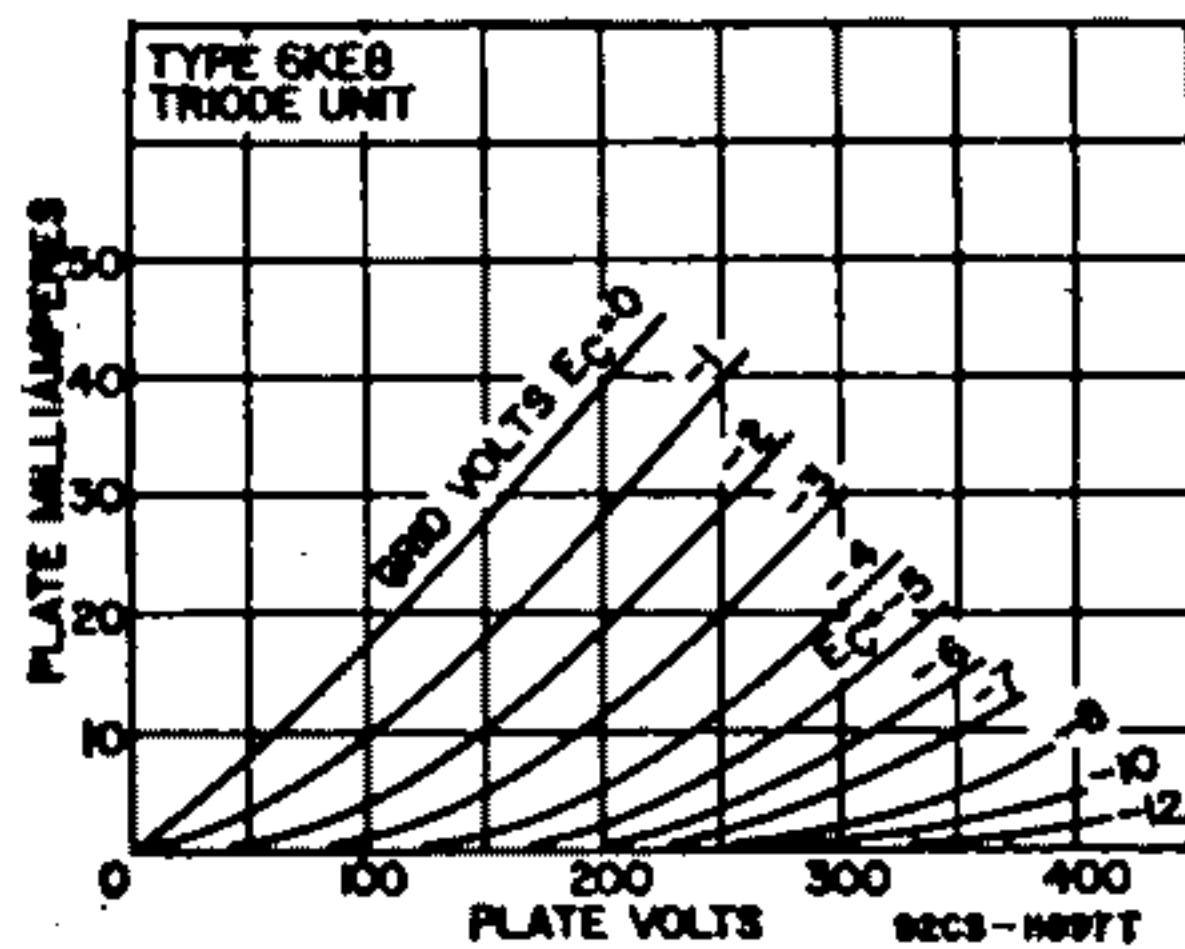
\* With external shield connected to ground.

**Class A<sub>1</sub> Amplifier**

**MAXIMUM RATINGS (Design-Maximum Values)**

Plate Voltage .....	280	280	volts
Grid-No.2 (Screen-Grid) Supply Voltage .....	—	280	volts
Grid-No.2 Voltage .....	—	See curve page 96	
Grid-No.1 (Control-Grid) Voltage, Positive-bias value .....	0	0	volts
Cathode Current .....	20	20	mA
Plate Dissipation .....	2	2	watts
Grid-No.2 Input:			
For grid-No.2 voltages up to 140 volts .....	—	0.5	watt
For grid-No.2 voltages between 140 and 280 volts .....	—	See curve page 96	

Triode Unit	Pentode Unit	
280	280	volts
—	280	volts
—	See curve page 96	
0	0	volts
20	20	mA
2	2	watts
—	0.5	watt
—	See curve page 96	

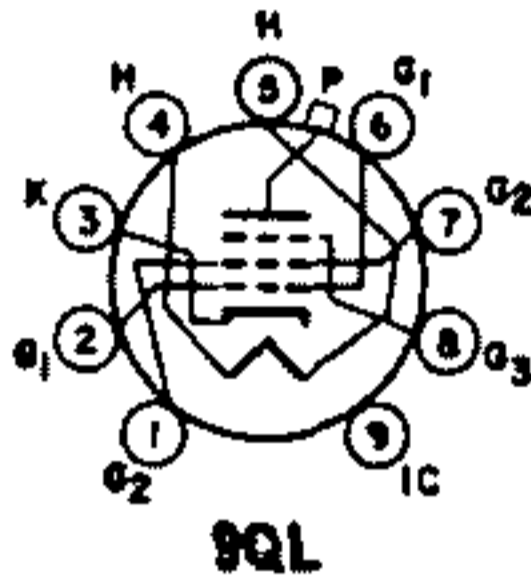


**CHARACTERISTICS**

Plate Supply Voltage .....	125	125	volts
Grid-No.2 Supply Voltage .....	—	125	volts
Grid-No.1 Supply Voltage .....	0	0	volts
Cathode-Bias Resistor .....	68	33	ohms
Amplification Factor .....	40	—	
Plate Resistance (Approx.) .....	5000	125000	ohms
Transconductance .....	8000	12000	$\mu$ mhos
Plate Current .....	18	10	mA
Grid-No.2 Current .....	—	2.8	mA
Grid-No.1 Voltage (Approx.):			
For plate current of 100 $\mu$ A .....	5	—	volts
For plate current of 50 $\mu$ A .....	—	—3	volts
<b>MAXIMUM CIRCUIT VALUES</b>			
Grid-No.1-Circuit Resistance:			
For fixed-bias operation .....	0.5	0.25	megohms
For cathode-bias operation .....	1	0.5	megohm

Refer to chart at end of section.

**6KL8**



**BEAM POWER TUBE**

**6KM6**

Novar type used as horizontal-deflection amplifier in color and black-and-white television receivers. Outlines section, 18A; requires novar 9-contact socket.

Heater Voltage (ac/dc) .....	6.3	volts
Heater Current .....	1.6	amperes
Heater-Cathode Voltage:		
Peak value .....	$\pm 200$ max	volts
Average value .....	100 max	volts
Direct Interelectrode Capacitances:		
Grid No.1 to Plate .....	1.2	pF
Grid No.1 to Cathode, Heater, Grid No.2, and Grid No.3 .....	22	pF
Plate to Cathode, Heater, Grid No.2, and Grid No.3 .....	9	pF

**Class A<sub>1</sub> Amplifier**

CHARACTERISTICS	Triode Connection		Pentode Connection		
Plate Voltage .....	140	—	60	140	volts
Peak Positive-Pulse Plate Voltage** .....	—	6500	—	—	volts
Grid-No.3 (Suppressed-Grid) Voltage .....	0	30	30	30	volts
Grid-No.2 (Screen-Grid) Voltage .....	140	140	140	140	volts
Grid-No.1 (Control-Grid) Voltage .....	—24.5	—	0	—24.5	volts
Amplification Factor .....	4	—	—	—	
Plate Resistance (Approx.) .....	—	—	—	6000	ohms
Transconductance .....	—	—	—	9500	$\mu$ mhos
Plate Current .....	—	—	560††	80	mA
Grid-No.2 Current .....	—	—	31††	2.4	mA
Grid-No.1 Voltage for plate current of 1 mA .....	—	—110	—	—42	volts

**Horizontal-Deflection Amplifier**

For operation in a 525-line, 30-frame system

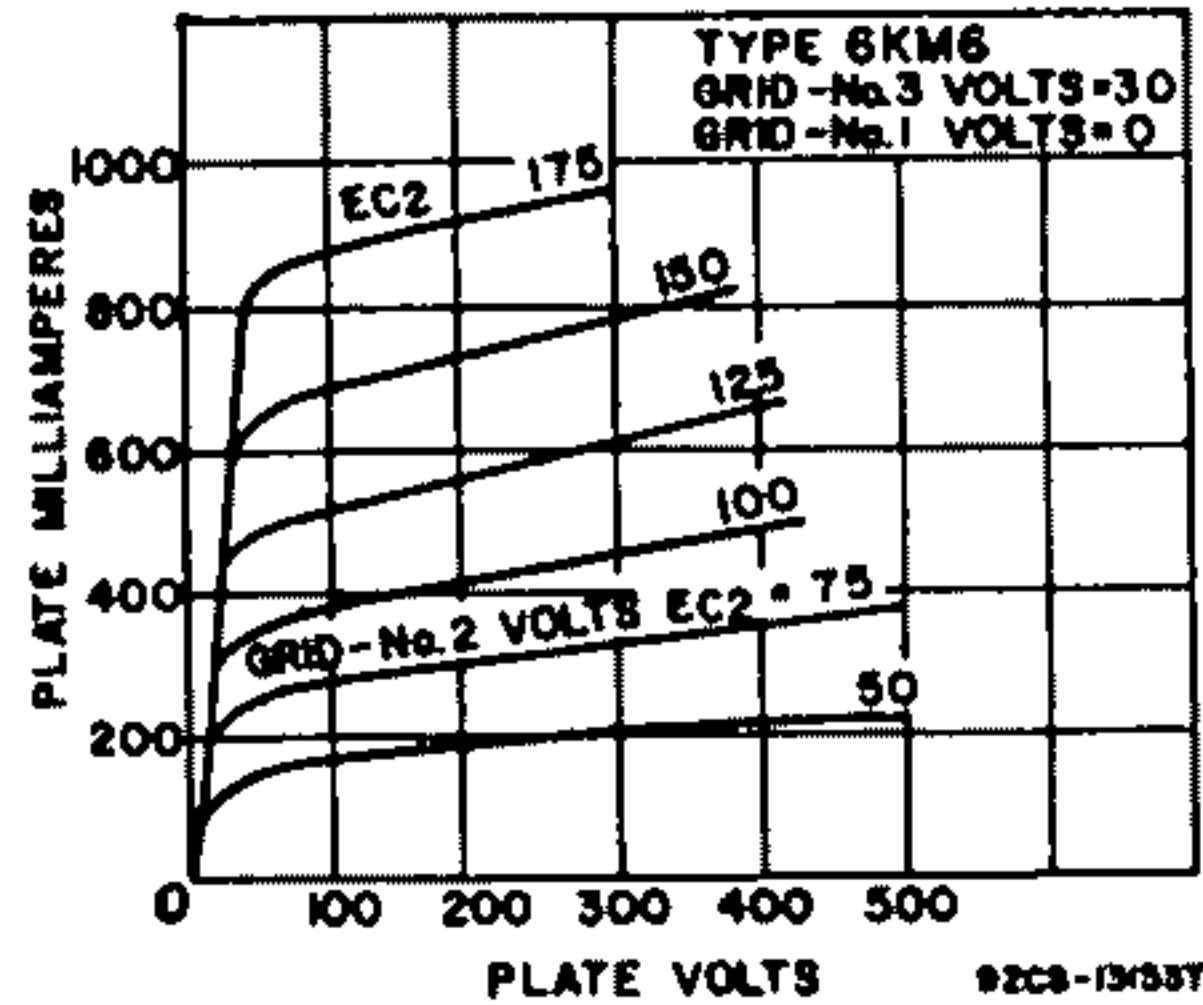
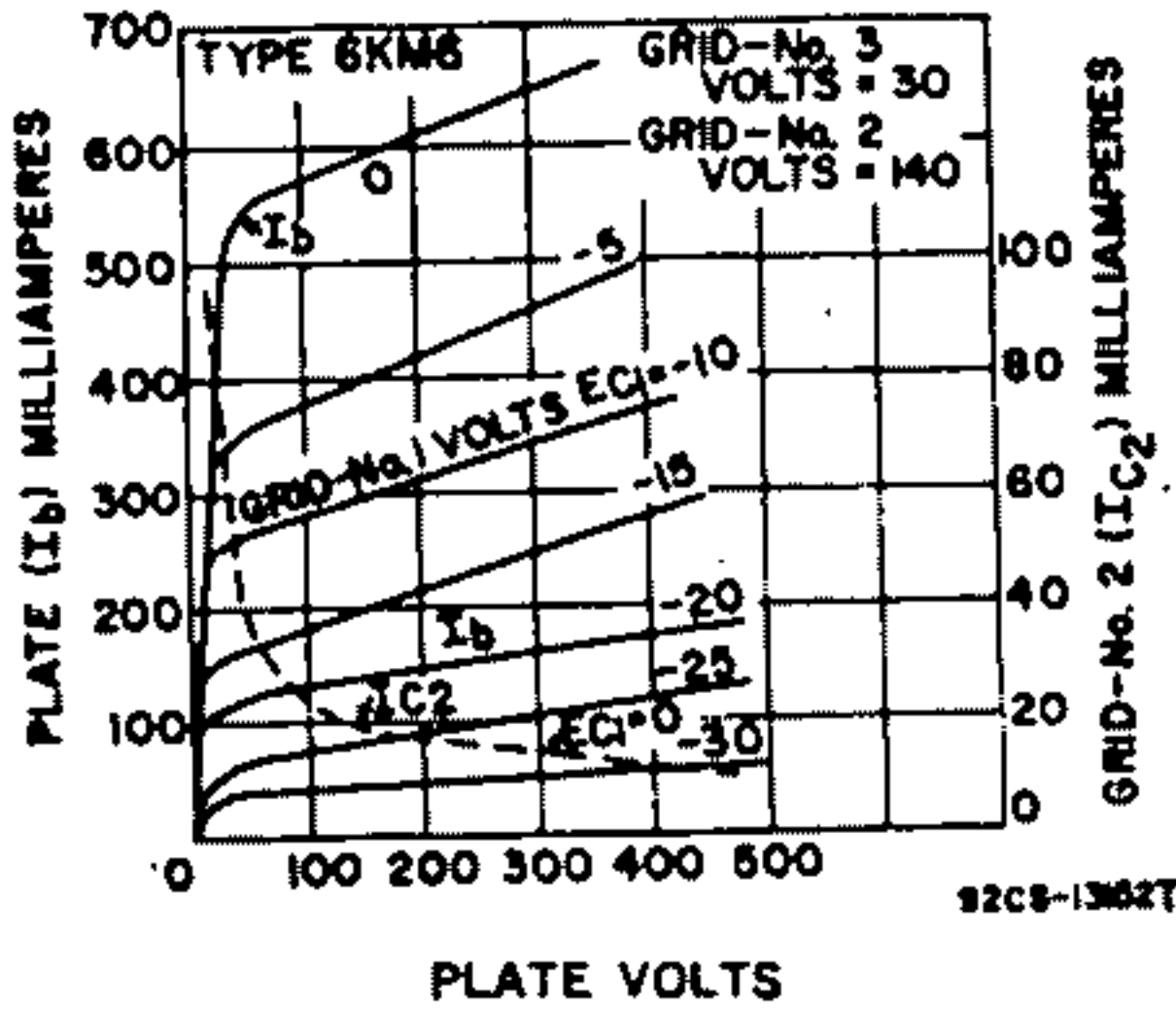
**MAXIMUM RATINGS (Design-Maximum Values)**

DC Plate Supply Voltage .....	770	volts
Peak Positive-Pulse Plate Voltage* .....	6500	volts
Peak Negative-Pulse Plate Voltage .....	—1500	volts
DC Grid-No.3 Voltage .....	75	volts
DC Grid-No.2 Voltage .....	220	volts
Peak Negative-Pulse Grid-No.1 Voltage .....	—330	volts
Peak Cathode Current .....	950	mA
Average Cathode Current .....	275	mA
Grid-No.2 Input .....	3.5	watts
Plate Dissipation** .....	20	watts
Bulb Temperature (At hottest point) .....	240	$^{\circ}$ C

**MAXIMUM CIRCUIT VALUES**

Grid-No.1-Circuit Resistance:		
For grid-resistor-bias operation .....	0.47	megohm
For plate-pulsed operation .....	10	megohms

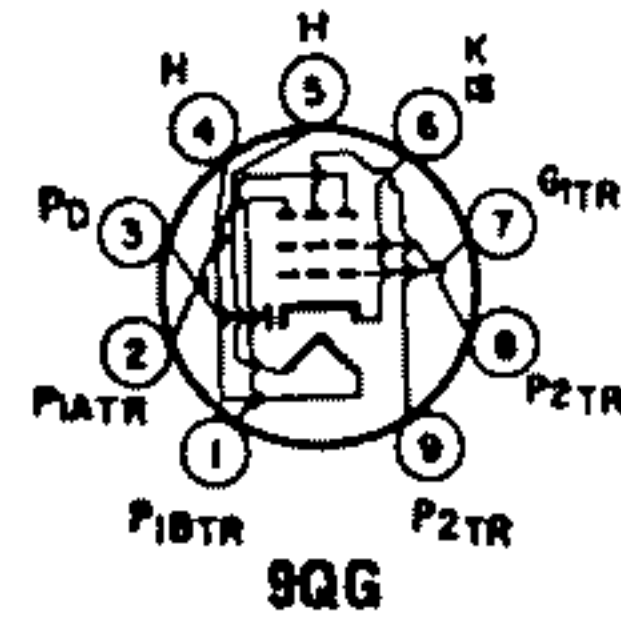
- # Pulse duration must not exceed 15% of a horizontal scanning cycle (10 microseconds).
- † With grid No.3 and grid No.2 connected, respectively, to cathode and plate at socket.
- †† This value can be measured by a method involving a recurrent waveform such that the maximum ratings of the tube will not be exceeded.
- \* In this service, a positive value may be applied to grid No.3 to minimize "snivets" interference; a typical value for this voltage is 30 volts.
- \*\* A bias resistor or other means is required to protect the tube in absence of excitation.



## 6KM8

## DIODE— THREE-PLATE TETRODE

Miniature type used in frequency-divider and complex-wave generator circuits of electronic musical instruments. In such circuits the tetrode unit can provide three independent output-signal voltages; the diode unit can be used as a key in a vibrato circuit. Outlines section, 6E; requires miniature 9-contact socket.



Heater Voltage (ac/dc)	6.3	volts
Heater Current	0.8	ampere
Heater-Cathode Voltage:		
Peak value	±200 max	volts
Average value	100 max	volts
Direct Interelectrode Capacitances:		
Tetrode Unit:		
Grid No.1 to Plate No.1A	0.02 max	pF
Grid No.1 to Plate No.1B	0.02 max	pF
Grid No.1 to Plate No.2	0.06 max	pF
Grid No.1 to Cathode, Heater, Grid No.2, and Internal Shield	5.5	pF
Plate No.1A to Cathode, Heater, Grid No.2, and Internal Shield	1.2	pF
Plate No.1B to Cathode, Heater, Grid No.2, and Internal Shield	1.8	pF
Plate No.2 to Cathode, Heater, Grid No.2, and Internal Shield	1.8	pF
Tetrode Grid No.1 to Diode Plate	0.024 max	pF
Tetrode Plate No.1A to Diode Plate	0.18	pF
Tetrode Plate No.1B to Diode Plate	0.024	pF
Tetrode Plate No.2 to Diode Plate	0.015	pF

### Tetrode Unit as Class A<sub>1</sub> Amplifier

Plates No. 1A, 1B, and 2 connected together

<b>CHARACTERISTICS</b>		
Plate Voltage	100	volts
Grid-No.2 Voltage	100	volts
Grid-No.1 Supply Voltage	0	volts
Grid-No.1 Resistor (Bypassed)	2.2	megohms
Plate Resistance (Approx.)	30000	ohms
Transconductance	3400	μmhos
Plate Current	4.2	mA
Grid-No.2 Current	1.7	mA
Grid-No.1 Voltage (Approx.) for plate current of 20 μA	-4	volts
Triode Connection—Plates No.1A, 1B, and 2 connected to grid No.2		
Plate Voltage	100	volts
Grid-No.1 Supply Voltage	0	volts
Grid-No.1 Resistor (Bypassed)	2.2	megohms



Transconductance .....	4500	μmhos
Amplification Factor .....	45	
Plate Current .....	5.5	mA

Separate-plate operation; plates not under test grounded

Plate	1A	1B	2	
Plate Voltage .....	100	100	100	volts
Grid-No.2 Voltage .....	100	100	100	volts
Grid-No.1 Supply Voltage .....	0	0	0	volts
Grid-No.1 Resistor (Bypassed) .....	2.2	2.2	2.2	megohms
Transconductance .....	2000	2000	1800	μmhos
Plate Resistance (Approx.) .....	0.1	0.1	0.12	megohm
Plate Current .....	2.3	2.3	2.1	mA
Grid-No.2 Current .....	3.8	3.8	3.3	mA

**Tetrode Unit as Frequency Divider and Complex-Wave Generator**

**MAXIMUM RATINGS (Design-Maximum Values)**

Plate Voltage (Each plate) .....	330	volts
Grid-No.2 (Screen-Grid) Supply Voltage .....	330	volts
Grid-No.2 Voltage .....	See curve page 96	
Grid-No.1 (Control-Grid) Voltage:		
Positive-bias value .....	0	volts
Negative-bias value .....	-50	volts
Plate Dissipation (Each plate) .....	1	watt
Grid-No.2 Input:		
For grid-No.2 voltages up to 165 volts .....	0.65	watt
For grid-No.2 voltages between 165 and 330 volts .....	See curve page 96	

**MAXIMUM CIRCUIT VALUE**

Grid-No.1-Circuit Resistance, for grid-No.1-resistor-bias operation .....	2.2	megohms
---	-----	---------

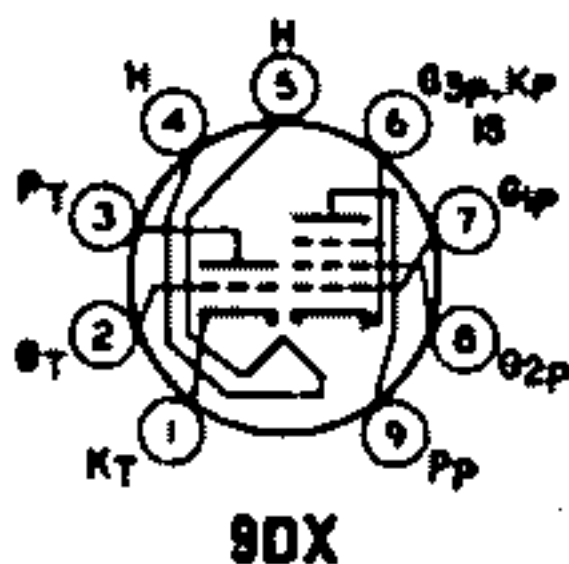
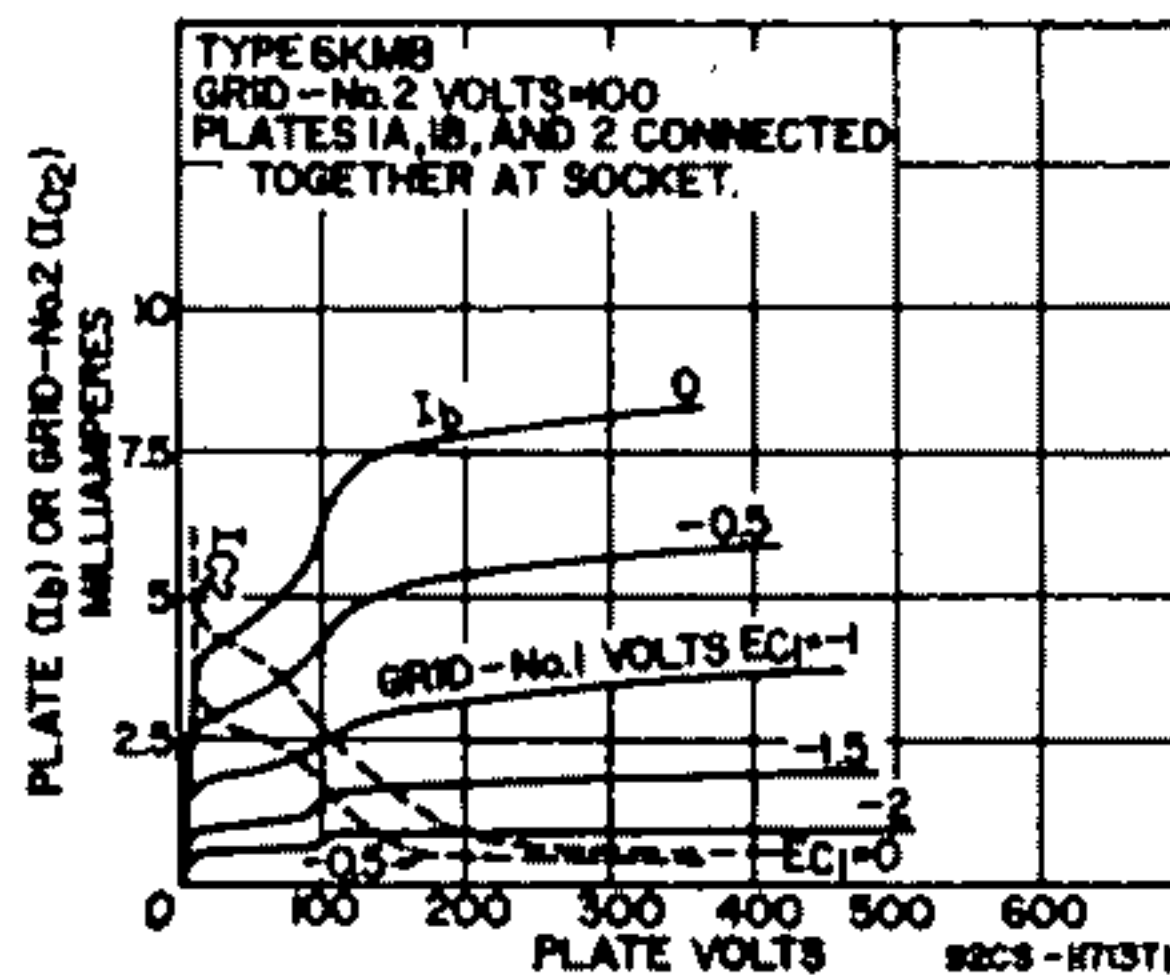
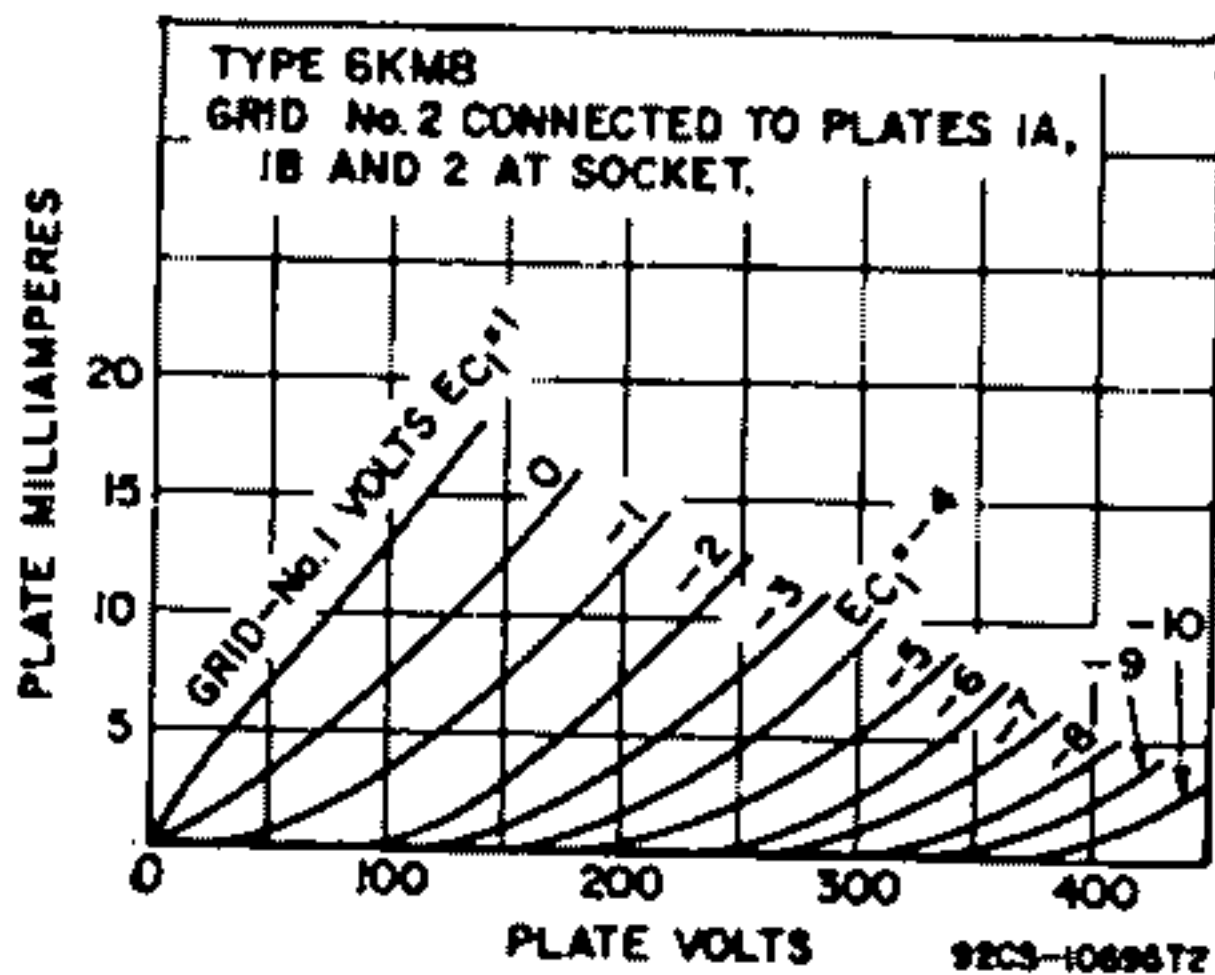
**Diode Unit**

**MAXIMUM RATINGS (Design-Maximum Values)**

Plate Current .....	1	mA
---------------------	---	----

**CHARACTERISTICS, Instantaneous Value**

Tube Voltage Drop for plate current of 2 mA .....	10	volts
---	----	-------



**MEDIUM-MU TRIODE—  
SHARP-CUTOFF PENTODE**

**6KR8  
10KR8**

Miniature type used in television receiver applications. The triode unit is used as a general-purpose amplifier; the pentode unit is used as a video amplifier. Outlines section, 6E; requires miniature 9-contact socket. Type 10KR8 is identical with type 6KR8 except for heater ratings.

Heater Voltage (ac/dc) .....	6.8	10.5	volts
Heater Current .....	0.75	0.45	ampere
Heater Warm-up Time (Average) .....	—	11	seconds
Heater-Cathode Voltage:			
Peak value .....	±200 max	±200 max	volts
Average value .....	100 max	100 max	volts

**Class A<sub>1</sub> Amplifier**

MAXIMUM RATINGS (Design-Maximum Values)		Triode Unit	Pentode Unit	
Plate Voltage		—	330	volts
Grid-No.2 (Screen-Grid) Supply Voltage		330	330	volts
Grid-No.2 Voltage		—	See curve page 96	
Grid-No.1 (Control-Grid) Voltage, Positive-bias value		0	0	volts
Plate Dissipation		2	5	watts
Grid-No.2 Input:				
For voltages up to 165 volts		—	1.1	watts
For voltages between 165 and 330 volts		—	See curve page 96	

CHARACTERISTICS		Triode Unit	Pentode Unit	
Plate Supply Voltage		125	85 200	volts
Grid-No.2 Supply Voltage		—	100	100
Grid-No.1 Voltage		—	0	—
Cathode-Bias Resistor		68	—	82
Amplification Factor		46	—	—
Plate Resistance (Approx.)		4400	—	60000
Transconductance		10400	—	20000
Plate Current		15	54	19.5
Grid-No.2 Current		—	13.5	8
Grid-No.1 Voltage (Approx.) for plate current of 10 $\mu$ A		-8	—	—
Grid-No.1 Voltage (Approx.) for plate current of 100 $\mu$ A		—	—	-6.3

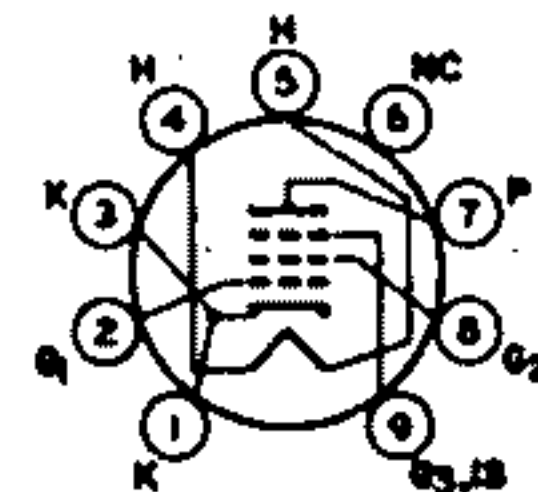
MAXIMUM CIRCUIT VALUES		Triode Unit	Pentode Unit	
Grid-No.1-Circuit Resistance:				
For fixed-bias operation		0.5	0.5	megohm
For cathode-bias operation		1.0	1.0	megohm

**6KT6**

3KT6, 4KT6

**SEMIREMOTE-CUTOFF PENTODE**

Miniature type used as if-amplifier tube in television receivers utilizing an intermediate frequency in the order of 40 MHz. Outlines section, 6B; requires miniature 7-contact socket. Types 3KT6 and 4KT6 are identical with type 6KT6 except for heater ratings.



9PM

	3KT6	4KT6	6KT6	
Heater Voltage (ac/dc)	3.5	4.5	6.3	volts
Heater Current	0.6	0.45	0.3	ampere
Heater Warm-up Time (Average)	11	11	—	seconds
Heater-Cathode Voltage:				
Peak value	±200 max	±200 max	±200 max	volts
Average value	100 max	100 max	100 max	volts
Direct Interelectrode Capacitances:				
Grid No.1 to Plate			0.019 max	pF
Grid No.1 to Cathode, Heater, Grid No.2, Grid No.3, and Internal Shield			9.5	pF
Plate to Cathode, Heater, Grid No.2, Grid No.3, and Internal Shield			3	pF

**Class A<sub>1</sub> Amplifier**

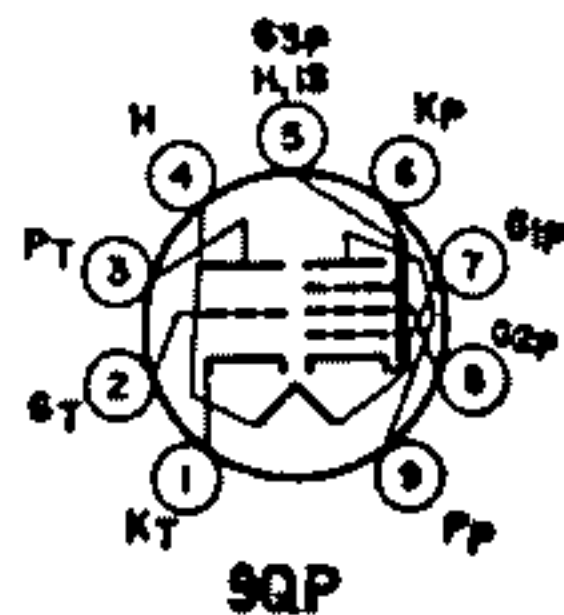
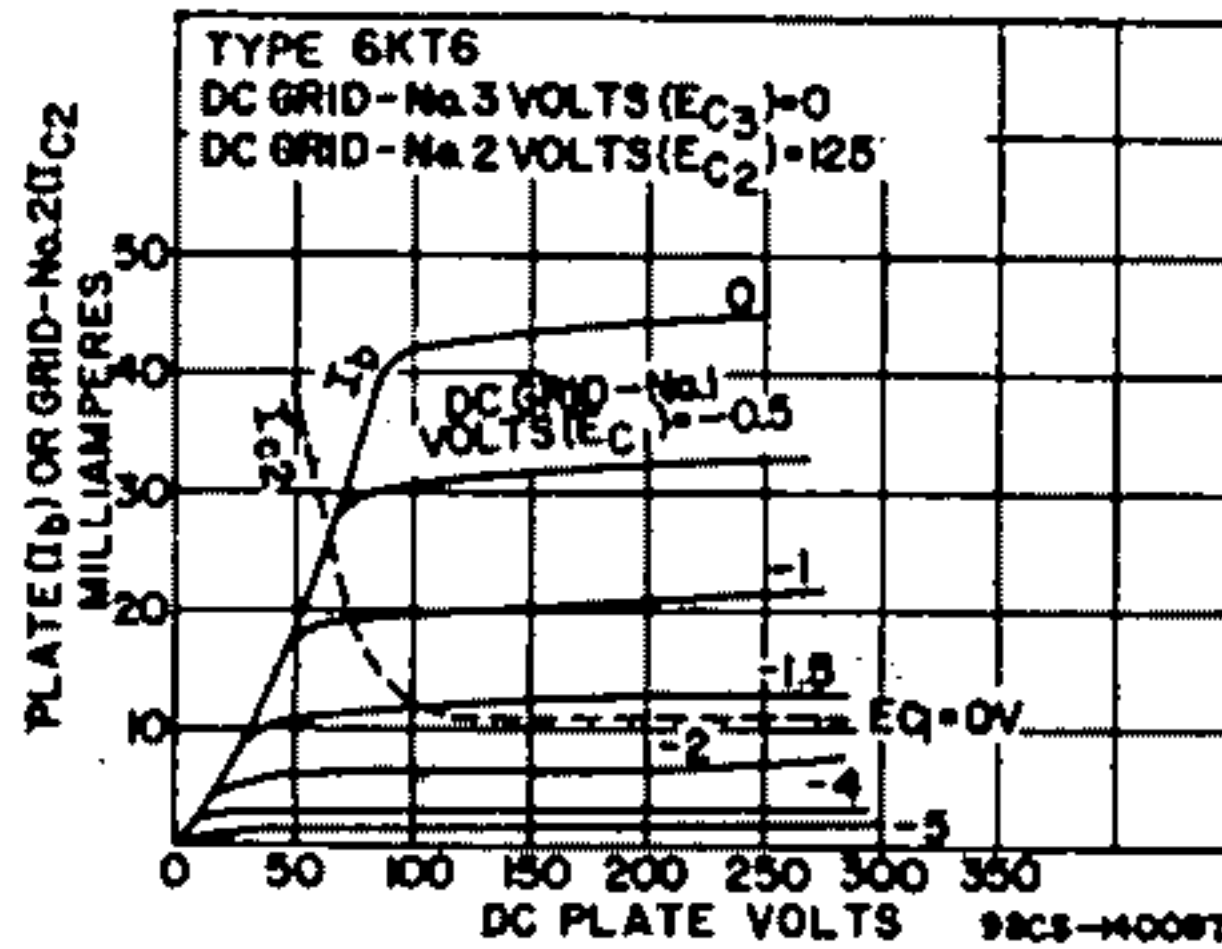
MAXIMUM RATINGS (Design-Maximum Values)			
Plate Voltage		330	volts
Grid-No.3 (Suppressor-Grid) Voltage		0	volts
Grid-No.2 (Screen-Grid) Supply Voltage		330	volts
Grid-No.2 Voltage		See curve page 96	
Grid-No.1 (Control-Grid) Voltage		0	volts
Plate Dissipation		3.1	watts
Grid-No.2 Input:			
For grid-No.2 voltages up to 165 volts		0.6	watt
For grid-No.2 voltages between 165 and 330 volts		See curve page 96	

CHARACTERISTICS			
Plate Supply Voltage		125	170
Grid-No.3 Voltage		0	0
Grid-No.2 Supply Voltage		125	170
Cathode-Bias Resistor		56	56
Plate Resistor		16000	—
Transconductance		18000	—
Plate Current		17	—
Grid-No.2 Current		4.2	—
Grid-No.1 Voltage (Approx.) for transconductance of 10 $\mu$ mbos		—	-22

**MAXIMUM CIRCUIT VALUES**

Grid-No.1-Circuit Resistance:

For fixed-bias operation .....	—	0.25	megohm
For cathode-bias operation .....	—	1	megohm



**HIGH-MU TRIODE— SHARP-CUTOFF PENTODE 6KT8**

Miniature type used in color and black-and-white television receiver applications. The pentode unit is used as an if-amplifier tube, and the triode unit as a sync-separator or voltage-amplifier tube. Outlines section, 6B; requires miniature 9-contact socket.

Heater Voltage (ac/dc) .....	6.3	volts	
Heater Current .....	0.6	ampere	
Heater-Cathode Voltage:			
Peak value .....	±200 max	volts	
Average value .....	100 max	volts	
Direct Interelectrode Capacitances:	Unshielded	Shielded	
Triode Unit:			
Grid to Plate .....	3.0	3.0	pF
Grid to Cathode, Heater, Grid No.3 of Pentode Unit, and Internal Shield .....	3.2	3.2	pF
Plate to Cathode, Heater, Grid No.3 of Pentode Unit, and Internal Shield .....	1.6	2.4	pF
Pentode Unit:			
Grid No.1 to Plate .....	0.046 max	0.030 max	pF
Grid No.1 to Cathode, Heater, Grid No.2, Grid No.3, and Internal Shield .....	7.5	7.5	pF
Plate to Cathode, Heater, Grid No.2, Grid No.3, and Internal Shield .....	2.2	2.8	pF
Grid of Triode Unit to Plate of Pentode Unit .....	0.018 max	0.008 max	pF
Grid No.1 of Pentode Unit to Plate of Triode Unit .....	0.006 max	0.002 max	pF

**Class A<sub>1</sub> Amplifier**

<b>MAXIMUM RATINGS (Design-Maximum Values)</b>	Triode Unit	Pentode Unit	
Plate Voltage .....	330	330	volts
Grid-No.2 (Screen-Grid) Supply Voltage .....	—	330	volts
Grid-No.2 Voltage .....	—	See curve page 96	
Grid-No.1 (Control-Grid) Voltage, Positive-bias value .....	0	0	volts
Plate Dissipation .....	1	2.5	watts
Grid-No.2 Input:			
For grid-No.2 voltages up to 165 volts .....	—	0.55	watt
For grid-No.2 voltages between 165 and 330 volts .....	—	See curve page 96	
<b>CHARACTERISTICS</b>			
Plate Voltage .....	250	125	volts
Grid-No.2 Voltage .....	—	125	volts
Grid-No.1 Voltage .....	—2	—1	volts
Amplification Factor .....	100	—	
Plate Resistance (Approx.) .....	31500	150000	ohms
Transconductance .....	3200	10000	μmhos

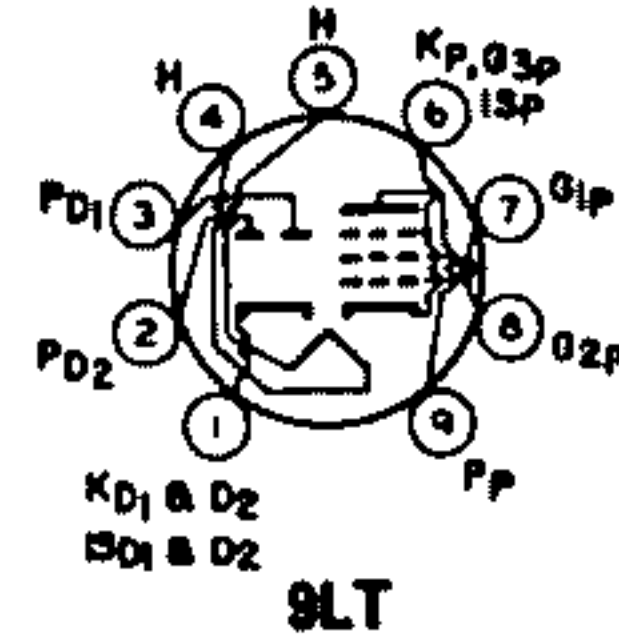


Plate Current .....	1.8	12	mA
Grid-No.2 Current .....	—	4.5	mA
Grid-No.1 Voltage (Approx.) for plate current of 20 $\mu$ A .....	-2.5	-7	volts
<b>MAXIMUM CIRCUIT VALUES</b>			
Grid-No.1-Circuit Resistance:			
For fixed-bias operation .....	0.5	0.5	megohm
For cathode-bias operation .....	1	1	megohm

**6KU8**  
10KU8

**TWIN DIODE—  
SHARP-CUTOFF PENTODE**

Neonovial type with frame-grid pentode used in television receiver applications. Diode units are used as horizontal phase detectors and the pentode unit is used as a video amplifier. Outlines section, 10A; requires neonovial 9-contact socket. Type 10KU8 is identical with type 6KU8 except for heater ratings.



Heater Voltage (ac/dc) .....	6KU8 6.3	10KU8 10.2	volts
Heater Current .....	0.725	0.45	ampere
Heater Warm-up Time (Average) .....	—	11	seconds
Heater-Cathode Voltage:			
Peak value .....	$\pm 200$ max	$\pm 200$ max	volts
Average value .....	100 max	100 max	volts

Direct Interelectrode Capacitances:			
Diode Units:			
Plate of Diode Unit No.1 to All Other Electrodes .....		1.1	pF
Plate of Diode Unit No.2 to All Other Electrodes .....		1.1	pF
Diode Cathode to Plate of Diode Unit No.1 .....		5.5	pF
Diode Cathode to Plate of Diode Unit No.2 .....		5.5	pF
Pentode Unit:			
Grid No.1 to Plate .....		0.1 max	pF
Grid No.1 to Pentode Cathode, Diode Cathode, Heater, Grid No. 2, Grid No.3, and Internal Shields .....		12	pF
Plate to Pentode Cathode, Diode Cathode, Heater, Grid No.2, Grid No.3, and Internal Shields .....		3	pF
Pentode Grid No.1 to Plate of Diode Unit No.1 .....		0.003 max	pF
Pentode Grid No.1 to Plate of Diode Unit No.2 .....		0.003 max	pF
Pentode Plate to Plate of Diode Unit No.1 .....		0.008 max	pF
Pentode Plate to Plate of Diode Unit No.2 .....		0.008 max	pF

**Pentode Unit as Class A<sub>1</sub> Amplifier**

<b>MAXIMUM RATINGS (Design-Maximum Values)</b>			
Plate Voltage .....		330	volts
Grid-No.2 (Screen-Grid) Supply Voltage .....		330	volts
Grid-No.2 Voltage .....		See curve page 96	
Grid-No.1 (Control-Grid) Voltage, Positive-bias value .....		0	volts
Plate Dissipation .....		4	watts
Grid-No.2 Input:			
For voltages up to 165 volts .....		1.1	watts
For voltages between 165 and 330 volts .....		See curve page 96	

<b>CHARACTERISTICS</b>			
Plate Supply Voltage .....	50	200	volts
Grid-No.2 Supply Voltage .....	100	100	volts
Grid-No.1 Voltage .....	0	0	volts
Cathode-Bias Resistor .....	—	82	ohms
Transconductance .....	—	20000	ambos
Plate Resistance (Approx.) .....	—	50000	ohms
Plate Current .....	55*	17	mA
Grid-No.2 Current .....	18*	3.5	mA
Grid-No.1 Voltage for plate current of 100 $\mu$ A .....	—	-5	volts

<b>MAXIMUM CIRCUIT VALUES</b>			
Grid-No.1-Circuit Resistance:			
For fixed-bias operation .....		0.25	megohm
For cathode-bias operation .....		1	megohm

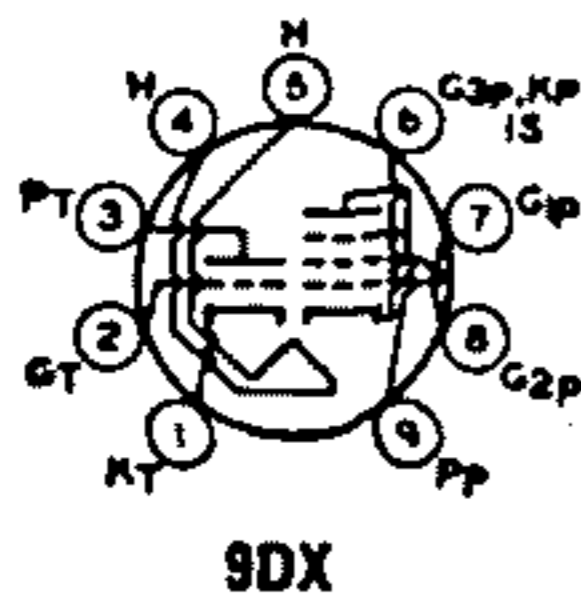
\* This value can be measured by a method involving a recurrent waveform such that the maximum ratings of the tube will not be exceeded.

**Diode Units (Each Unit)**

<b>CHARACTERISTICS, Instantaneous Value</b>			
Tube Voltage Drop for plate current of 2 mA .....		10	volts

**HIGH-MU TRIODE  
SHARP-CUTOFF PENTODE**

**6KV8  
11KV8**



Miniature type with frame-grid pentode unit used in black-and-white television receivers. The triode unit is used in general-purpose voltage-amplifier, sync-separator, and sound-if-amplifier applications. The pentode unit is used as a video-output tube. Outlines section, 6E; requires miniature 9-contact socket. For curves of average plate characteristics for triode unit, refer to type 6AW8A. Type 11KV8 is identical with type 6KV8 except for heater ratings.

Heater Voltage (ac/dc)	6KV8 6.3	11KV8 10.9	volts
Heater Current	0.775	0.45	ampere
Heater Warm-up Time (Average)	—	11	seconds
Heater-Cathode Voltage:			
Peak value	±200 max	±200 max	volts
Average value	100 max	100 max	volts
Direct Interelectrode Capacitances (Approx.):			
Triode Unit:			
Grid to Plate		3.7	pF
Grid to Cathode, Heater, Pentode Cathode, Pentode Grid No.3, and Internal Shield		2.5	pF
Plate to Cathode, Heater, Pentode Cathode, Pentode Grid No.3, and Internal Shield		2.4	pF
Triode Grid to Pentode Plate		0.015 max	
Pentode Unit:			
Grid No.1 to Plate		0.12 max	pF
Grid No.1 to Cathode, Heater, Grid No.2, Grid No.3, and Internal Shield		18	pF
Plate to Cathode, Heater, Grid No.2, Grid No.3, and Internal Shield		4.6	pF
Pentode Plate to Triode Plate		0.17 max	pF

**Class A<sub>1</sub> Amplifier**

<b>MAXIMUM RATINGS (Design-Maximum Values)</b>	Triode Unit	Pentode Unit		
Plate Voltage	300	300	volts	
Grid-No.2 (Screen-Grid) Supply Voltage	—	300	volts	
Grid-No.2 Voltage	—	See curve page 96		
Grid-No.1 (Control-Grid) Voltage, Positive-bias value	0	0	volts	
Plate Dissipation	1	5	watts	
Grid-No.2 Input:				
For grid-No.2 voltages up to 150 volts	—	1	watt	
For grid-No.2 voltages between 150 and 300 volts	—	See curve page 96		
<b>CHARACTERISTICS</b>	Triode Unit	Pentode Unit		
Plate Supply Voltage	200	125	200	volts
Grid-No.2 Supply Voltage	—	125	125	volts
Grid-No.1 Supply Voltage	—2	0	0	volts
Cathode-Bias Resistor	—	62	68	ohms
Amplification Factor	70	—	—	
Plate Resistance (Approx.)	17500	55000	75000	ohms
Transconductance	4000	21000	28000	μmhos

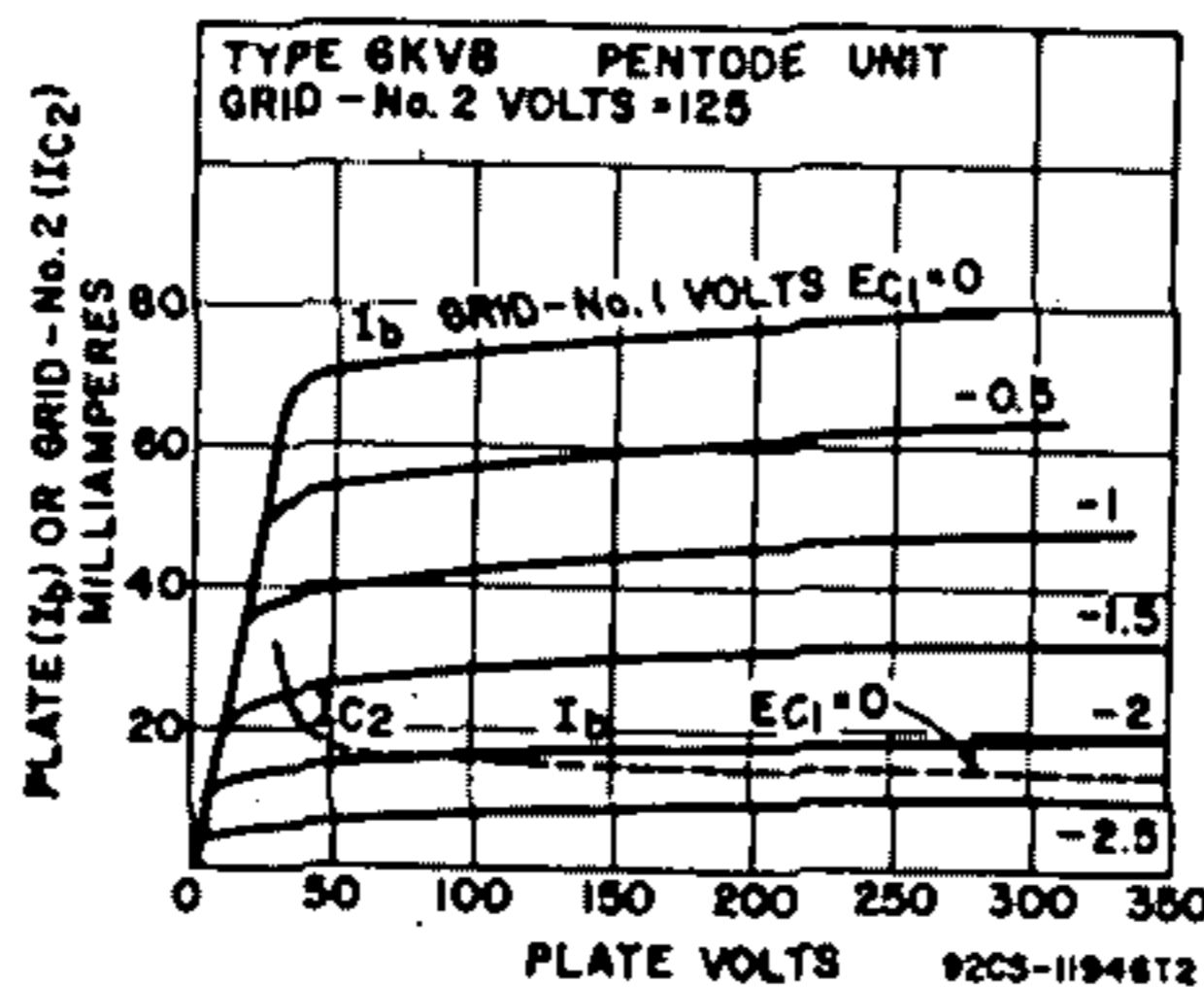


Plate Current	4	16.5	20	mA
Grid-No.2 Current	—	3.1	3.5	mA
Grid-No.1 Voltage (Approx.) for plate current of 100 $\mu$ A	-4.5	-4.2	-4.2	volts

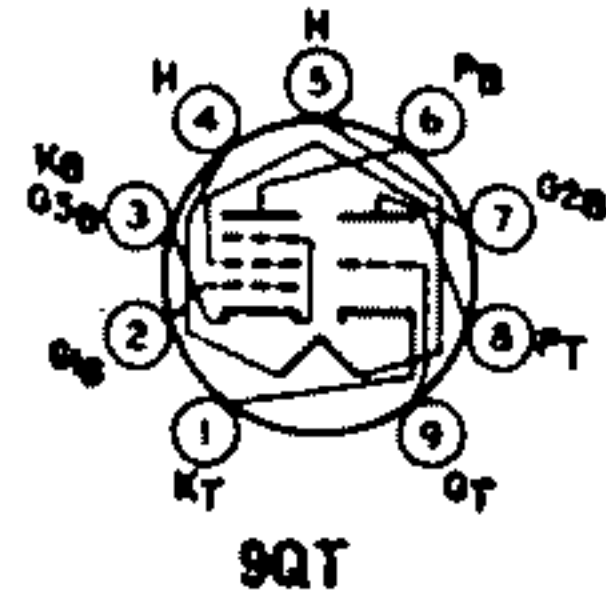
**MAXIMUM CIRCUIT VALUES**

Grid-No.1-Circuit Resistance:	Triode Unit	Pentode Unit	
For fixed-bias operation	0.5	0.1	megohm
For cathode-bias operation	1	0.25	megohm

**6KY8  
6KY8A**

15KY8, 15KY8A

**HIGH-MU TRIODE  
BEAM POWER TUBE**

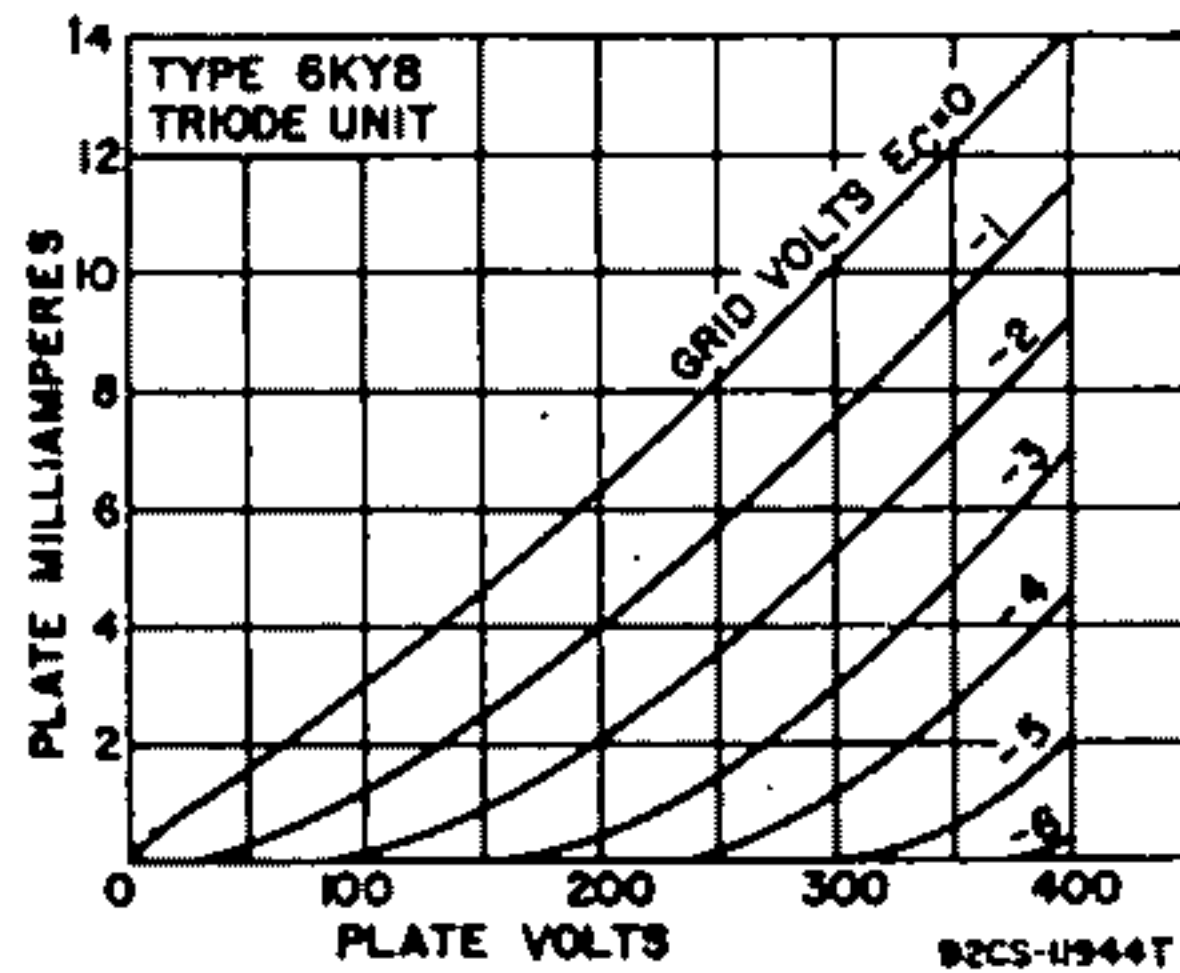
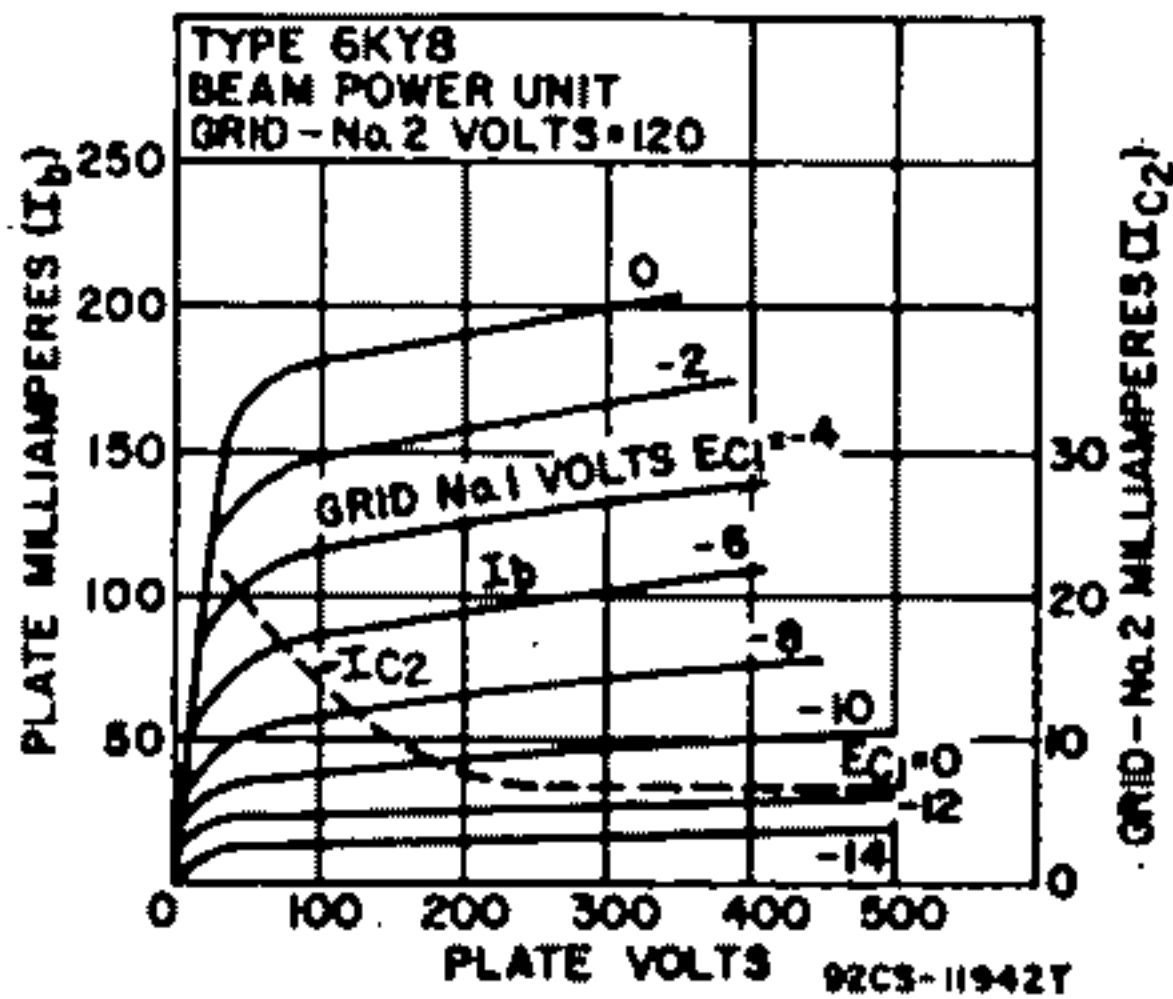


Novar types used in combined vertical-deflection-oscillator and vertical-deflection-amplifier applications in black-and-white television receivers having low-voltage "B" supplies. Outlines section, 11C and 30A, respectively; require novar 9-contact socket. Types 15KY8 and 15KY8A are identical with types 6KY8 and 6KY8A, except for heater ratings.

	6KY8 6KY8A	15KY8 15KY8A	
Heater Voltage (ac/dc)	6.3	15	volts
Heater Current	1.1	0.45	amperes
Heater Warm-up Time (Average)	—	11	seconds
Heater Cathode Voltage:			
Peak value	$\pm 200$ max	$\pm 200$ max	volts
Average value	100 max	100 max	volts
Direct Interelectrode Capacitances (Approx.):			
Triode Unit:			
Grid to Plate		0.44	pF
Grid to Cathode and Heater		15	pF
Plate to Cathode and Heater		7	pF
Pentode Unit:			
Grid No.1 to Plate		0.048	pF
Grid No.1 to Cathode, Heater, Grid No.2, and Grid No.3		2.6	pF
Plate to Cathode, Heater, Grid No.2, and Grid No.3		0.28	pF

**Class A<sub>1</sub> Amplifier**

CHARACTERISTICS	Triode Unit	Beam Power Unit			
Plate Voltage	250	50	135	120	volts
Grid-No.2 (Screen-Grid) Voltage	—	120	120	—	volts
Grid-No.1 (Control-Grid) Voltage	-3	0	-10	-10	volts
Amplification Factor	64	—	—	7	
Plate Resistance (Approx.)	40000	—	18000	—	ohms
Transconductance	1600	—	8400	—	amhos
Plate Current	1.4	170*	39	—	mA
Grid-No.2 Current	—	20*	3	—	mA
Grid-No.1 Voltage (Approx.) for plate current of 1 mA	—	—	-24	—	volts





- \* Triode connection, grid No.2 connected to plate at socket.
- \* This value can be measured by a method involving a recurrent waveform such that the maximum ratings of the tube will not be exceeded.

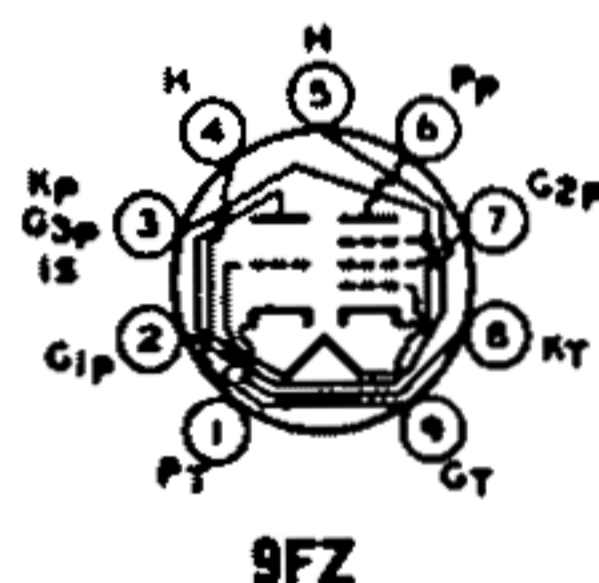
**Vertical-Deflection Oscillator and Amplifier**

For operation in a 525-line, 30-frame system

	Triode Unit Oscillator	Beam Power Unit Amplifier	
<b>MAXIMUM RATINGS (Design-Maximum Values)</b>			
DC Plate Voltage .....	330	300	volts
Peak Positive-Pulse Plate Voltage# (Absolute Maximum) .....	—	2200†	volts
DC Grid-No.2 Voltage .....	—	150	volts
Peak Negative-Pulse Grid-No.1 Voltage .....	-400	-250	volts
Peak Cathode Current .....	77	200	mA
Average Cathode Current .....	22	60	mA
Plate Dissipation .....	1.5	12	watts
Grid-No.2 Input .....	—	1.9	watts
<b>MAXIMUM CIRCUIT VALUES</b>			
Grid-No.1-Circuit Resistance: For grid-resistor-bias operation .....	2.2	2.2	megohms

# Pulse duration must not exceed 15% of a vertical scanning cycle (2.6 milliseconds).

† Under no conditions should this maximum value be exceeded.



9FZ

**MEDIUM-MU TRIODE SHARP-CUTOFF PENTODE**

**6KZ8**  
9KZ8

Miniature type used as combined oscillator and mixer in vhf color and black-and-white television receivers. Outlines section, 6B; requires miniature 9-contact socket. Type 9KZ8 is identical with type 6KZ8 except for heater ratings.

	6KZ8	9KZ8	
Heater Voltage (ac/dc) .....	6.3	9.45	volts
Heater Current .....	0.45	0.3	ampere
Heater Warm-up Time (Average) .....	11	11	seconds
Heater-Cathode Voltage:			
Peak value .....	±200 max	±200 max	volts
Average value .....	100 max	100 max	volts
<b>Direct Interelectrode Capacitances:*</b>			
<b>Triode Unit:</b>			
Grid to Plate .....		1.6	pF
Grid to Triode Cathode, Pentode Cathode, Heater, Pentode Grid No.3, and Heater .....		3.2	pF
Plate to Triode Cathode, Pentode Cathode, Heater, Pentode Grid No.3, and Heater .....		1.8	pF
<b>Pentode Unit:</b>			
Grid No.1 to Plate .....		0.01 max	pF
Grid No.1 to Cathode, Heater, Grid No.2, Grid No.3, and Internal Shield .....		5.5	pF
Plate to Cathode, Heater, Grid No.2, Grid No.3, and Internal Shield .....		3.4	pF
Heater to Cathode (Each Unit) .....		3.2#	pF

\* With external shield connected to cathode.

# With external shield connected to ground.

**Class A<sub>1</sub> Amplifier**

	Triode Unit	Pentode Unit	
<b>MAXIMUM RATINGS (Design-Maximum Values)</b>			
Plate Voltage .....	330	330	volts
Grid-No.2 (Screen-Grid) Supply Voltage .....	—	330	volts
Grid-No.2 Voltage .....	—	See curve page 96	
Grid No.1 (Control-Grid) Voltage, Positive-bias value .....	0	0	volts
Plate Dissipation .....	2.5	2.5	watts
Grid-No.2 Input:			
For grid-No.2 voltages up to 165 volts .....	—	0.55	watt
For grid-No.2 voltages between 165 and 330 volts .....	—	See curve page 96	
<b>CHARACTERISTICS</b>			
Plate Voltage .....	125	125	volts
Grid-No.2 Voltage .....	—	125	volts
Grid-No.1 Voltage .....	-1	-1	volt
Amplification Factor .....	46	—	

Plate Resistance (Approx.) .....	5400	200000	ohms
Transconductance .....	8500	7500	amhos
Plate Current .....	18.5	12	mA
Grid-No.2 Current .....	—	4	mA
Grid-No.1 Voltage (Approx.) for plate current of 10 $\mu$ A .....	-8	-8	volts
<b>MAXIMUM CIRCUIT VALUES</b>			
Grid-No.1-Circuit Resistance:			
For fixed-bias operation .....	0.25	0.25	megohm
For cathode-bias operation .....	0.6	0.5	megohm

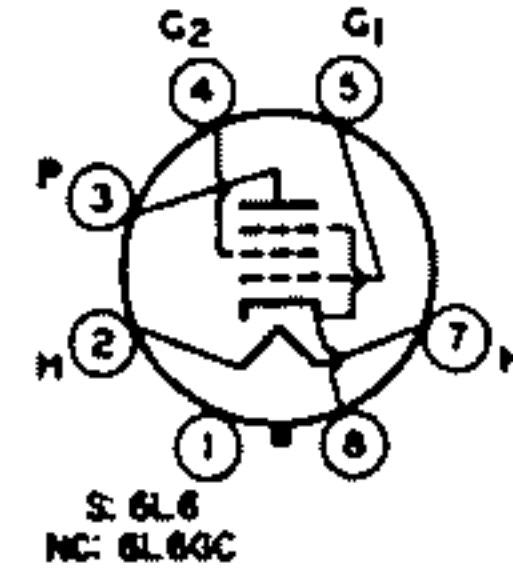
**6L5G**

Refer to chart at end of section.

**6L6  
6L6GC**

**BEAM POWER TUBE**

Metal type 6L6 and glass octal type 6L6GC are used in the output stage of audio amplifying equipment, especially units designed to have ample reserve of power-delivering ability. Outlines section, 4 and 19D, respectively; require octal socket. These tubes, like other power-handling tubes, should be adequately ventilated. Type 6L6GC can be used in place of type 6L6 and may be supplied with pin 1 omitted.



**7AC**

Heater Voltage (ac/dc) .....		6.3	volts
Heater Current .....		0.9	ampere
Heater-Cathode Voltage:			
Peak value .....	6L6 $\pm 180$ max	6L6GC $\pm 200$ max	volts
Average value .....	—	100 max	volts
Direct Interelectrode Capacitances (Approx.):			
Grid No.1 to Plate .....	0.4*	0.6	pF
Grid No.1 to Cathode, Heater, Grid No.2, and Grid No.3 .....	10*	10	pF
Plate to Cathode, Heater, Grid No.2, and Grid No.3 .....	12*	6.5	pF

\* With pin 1 connected to pin 8.

**Class A<sub>1</sub> Amplifier**

	6L6 Design-Center Values	6L6GC Design Maximum Values		
<b>MAXIMUM RATINGS</b>				
Plate Voltage .....	360	500	volts	
Grid-No.2 (Screen-Grid) Voltage .....	270	450 <sup>A</sup>	volts	
Plate Dissipation .....	19	30	watts	
Grid-No.2 Input .....	2.5	6	watts	
<b>TYPICAL OPERATION</b>				
Plate Voltage .....	250	300	350	volts
Grid-No.2 Voltage .....	250	200	250	volts
Grid-No.1 (Control-Grid) Voltage .....	-14	-12.5	-18	volts
Peak AF Grid-No.1 Voltage .....	14	12.6	18	volts
Zero-Signal Plate Current .....	72	48	64	mA
Maximum-Signal Plate Current .....	79	55	68	mA
Zero-Signal Grid-No.2 Current .....	5	2.5	2.5	mA
Maximum-Signal Grid-No.2 Current .....	7.3	4.7	7	mA
Plate Resistance (Approx.) .....	22500	35000	33000	ohms
Transconductance .....	6000	5300	5200	amhos
Load Resistance .....	2500	4500	4200	ohms
Total Harmonic Distortion .....	10	11	15	per cent
Maximum-Signal Power Output .....	6.5	6.5	10.8	watts

<sup>A</sup> In push-pull circuits where grid No.2 of each tube is connected to a tap on the plate winding of the output transformer, this maximum rating is 500 volts.

**Class A<sub>1</sub> Amplifier (Triode Connection)†**

	6L6 Design- Center Values	6L6GC Design- Maximum Values	
<b>MAXIMUM RATINGS</b>			
Plate Voltage .....	375	450	volts
Plate Dissipation (Total) .....	19	30	watts

**TYPICAL OPERATION**

Plate Voltage .....	250	volts
Grid-No.1 Voltage .....	-20	volts
Peak AF Grid-No.1 Voltage .....	20	volts
Zero-Signal Plate Current .....	40	mA
Maximum-Signal Plate Current .....	44	mA
Plate Resistance (Approx.) .....	1700	ohms
Amplification Factor .....	8	
Transconductance .....	4700	μmhos
Load Resistance .....	5000	ohms
Total Harmonic Distortion .....	5	per cent
Maximum-Signal Power Output .....	1.4	watts

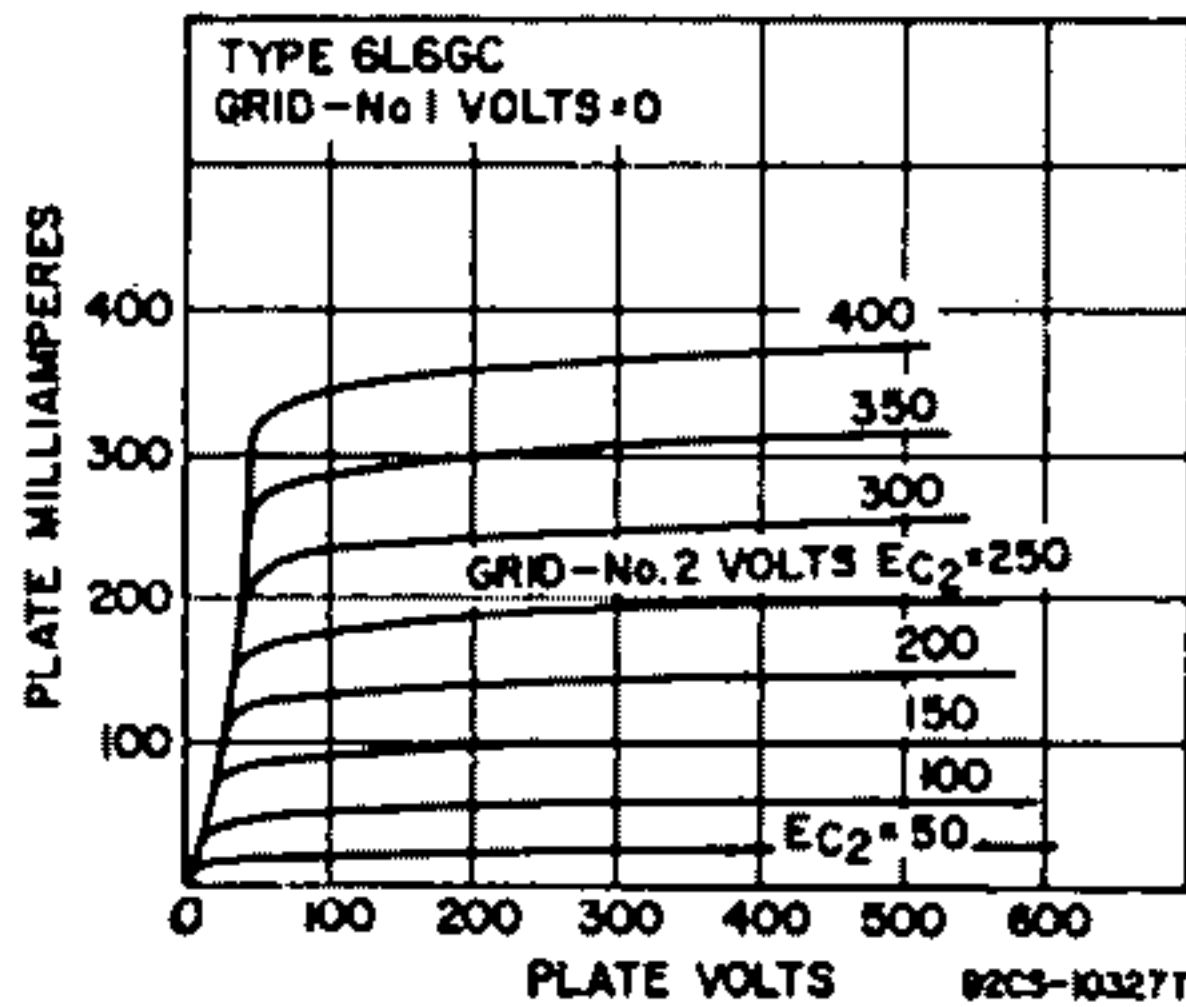
† Grid No.2 connected to plate.

**Push-Pull Class A<sub>1</sub> Amplifier**

MAXIMUM RATINGS (Same as for Class A<sub>1</sub> Amplifier)

TYPICAL OPERATION (Values are for two tubes)

Plate Voltage .....	250	270	volts
Grid-No.2 Voltage .....	250	270	volts
Grid-No.1 Voltage .....	-16	-17.5	volts
Peak AF Grid-No.1-to-Grid-No.1 Voltage .....	32	35	volts
Zero-Signal Plate Current .....	120	134	mA
Maximum-Signal Plate Current .....	140	155	mA
Zero-Signal Grid-No.2 Current .....	10	11	mA
Maximum-Signal Grid-No.2 Current .....	16	17	mA
Effective Load Resistance (Plate-to-plate) .....	5000	5000	ohms
Total Harmonic Distortion .....	2	2	per cent
Maximum-Signal Power Output .....	14.5	17.5	watts



MAXIMUM RATINGS (Same as for Class A<sub>1</sub> Amplifier)

TYPICAL OPERATION (Values are for two tubes)

	6L6	6L6	6L6GC	
Plate Voltage .....	360	360	450	volts
Grid-No.2 Voltage .....	270	270	400	volts
Grid-No.1 Voltage .....	-22.5	-22.5	-37	volts
Peak AF Grid-No.1-to-Grid-No.1 Voltage .....	45	45	70	volts
Zero-Signal Plate Current .....	88	88	118	mA
Maximum-Signal Plate Current .....	132	140	210	mA
Zero-Signal Grid-No.2 Current .....	5	5	5.6	mA
Maximum-Signal Grid-No.2 Current .....	15	11	22	mA
Effective Load Resistance (Plate-to-plate) .....	6600	3800	5600	ohms
Total Harmonic Distortion .....	2	2	1.8	per cent
Maximum-Signal Power Output .....	26.5	18	55	watts

**Push-Pull Class AB<sub>2</sub> Amplifier**

MAXIMUM RATINGS (Same as for Class A<sub>1</sub> Amplifier)

TYPICAL OPERATION (Values are for two tubes)

Plate Voltage .....	360	360	volts
Grid-No.2 Voltage .....	225	270	volts
Grid-No.1 Voltage .....	-18	-22.5	volts
Peak AF Grid-No.1-to-Grid-No.1 Voltage .....	52	72	volts
Zero-Signal Plate Current .....	78	88	mA
Maximum-Signal Plate Current .....	142	205	mA
Zero-Signal Grid-No.2 Current .....	3.5	5	mA
Maximum-Signal Grid-No.2 Current .....	11	16	mA



Effective Load Resistance (Plate-to-plate) .....	6000	8800	ohms
Total Harmonic Distortion .....	2	2	per cent
Maximum-Signal Power Output .....	31	47	watts

**MAXIMUM CIRCUIT VALUES**

Grid-No.1-Circuit Resistance:			
For fixed-bias operation .....	0.1		megohm
For cathode-bias operation .....	0.5		megohm

**6L6G** Refer to chart at end of section.

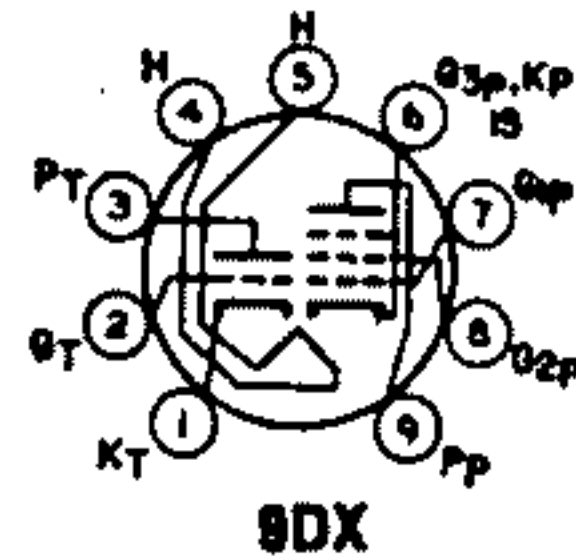
**6L6GB** Refer to chart at end of section.

**6L7** Refer to chart at end of section.

**6L7G** Refer to chart at end of section.

**6LB8 MEDIUM-MU TRIODE—  
SHARP-CUTOFF PENTODE**

Neonovial type with frame-grid pentode used in television receivers. Triode unit is used as a voltage amplifier, the pentode unit is used as a video amplifier. Outlines section, 10A; requires neonovial 9-contact socket. Heater: volts (ac/dc) 6.3; amperes, 0.725; maximum heater-cathode volts, ±200 peak, 100 average.



**Class A<sub>1</sub> Amplifier**

MAXIMUM RATINGS (Design-Maximum Values)	Triode Unit	Pentode Unit	
Plate Voltage .....	330	330	volts
Grid-No.2 (Screen-Grid) Supply Voltage .....	—	330	volts
Grid-No.2 Voltage .....	—	See curve page 96	
Grid-No.1 (Control-Grid) Voltage, Positive-bias value .....	0	0	volts
Plate Dissipation .....	2	4	watts
Grid-No.2 Input:			
For grid-No.2 voltages up to 165 volts .....	—	1.1	watts
For grid-No.2 Voltages between 165 and 330 volts .....	—	See curve page 96	

**CHARACTERISTICS**

Plate Supply Voltage .....	125	50	200	volts
Grid-No.2 Supply Voltage .....	—	100	100	volts
Grid-No.1 Voltage .....	0	0	0	volts
Cathode-Bias Resistor .....	68	—	82	ohms
Amplification Factor .....	30	—	—	
Plate Resistance (Approx.) .....	6000	—	50000	ohms
Transconductance .....	5000	—	20000	μmhos
Plate Current .....	18	55*	17	mA
Grid-No.2 Current .....	—	18*	3.5	mA
Grid-No.1 Voltage (Approx.) for plate current of 20 μA .....	—10	—	—	volts
Grid-No.1 Voltage (Approx.) for plate current of 100 μA .....	—	—	—5	volts

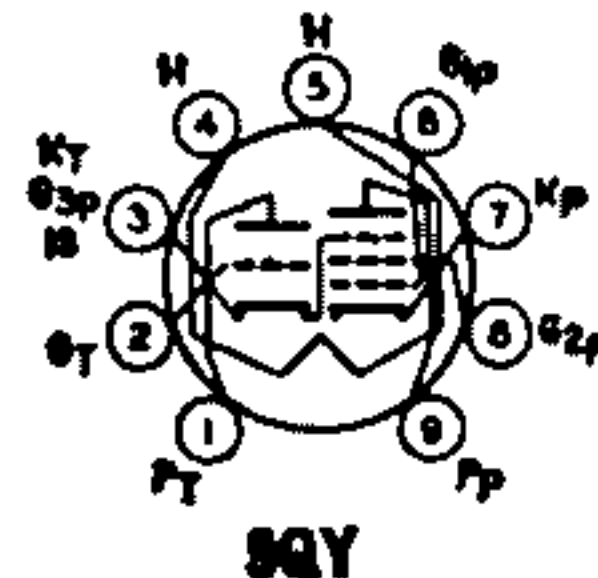
**MAXIMUM CIRCUIT VALUES**

Grid-No.1 Circuit Resistance:			
For fixed-bias operation .....	0.5	0.25	megohm
For cathode-bias operation .....	1	1	megohm

\* This value can be measured by a method involving a recurrent waveform such that the maximum ratings of the tube will not be exceeded.

**6LC8 HIGH-MU TRIODE—  
SHARP-CUTOFF PENTODE**

Miniature type used in color and black-and-white television receiver applications. Pentode unit is used in noise-immune gated-agc-amplifier circuits, and the triode unit in sync-separator circuits. Outlines section, 6E; requires miniature 9-contact socket. Type 8LC8 is identical with type 6LC8 except for heater ratings. For curves of average plate characteristics, refer to type 6KA8.



	6LC8	8LC8	
Heater Voltage (ac/dc) .....	6.8	8.4	volts
Heater Current .....	0.6	0.45	ampere
Heater Warm-up Time (Average) .....	11	11	seconds
Heater-Cathode Voltage:			
Peak value .....	±200 max	±200 max	volts
Average value .....	100 max	100 max	volts
Direct Interelectrode Capacitances:			
Triode Unit:			
Grid to Plate .....		2.2	pF
Grid to Cathode, Heater, Pentode Grid No.3, and Internal Shield .....		2.8	pF
Plate to Cathode, Heater, Pentode Grid No.3, and Internal Shield .....		2.2	pF
Pentode Unit:			
Grid No.1 to Plate .....		0.10 max	pF
Grid No.1 to Cathode, Heater, Grid No.3, Triode Cathode, and Internal Shield .....		10	pF
Grid No.3, Triode Cathode, and Internal Shield to Plate .....		3.4	pF
Grid No.1 to Grid No.3, Triode Cathode, and Internal Shield .....		0.36	pF
Grid No.3, Triode Cathode, and Internal Shield to Plate, Cathode, Heater, Grid No.1, and Grid No.2 .....		12.6	pF

**Class A<sub>1</sub> Amplifier**

MAXIMUM RATINGS (Design-Maximum Values)		Triode Unit	
Plate Voltage .....		300	volts
Grid Voltage:			
Positive-bias value .....		0	volts
Negative-bias value .....		-50	volts
Plate Dissipation .....		1.1	watts
CHARACTERISTICS		Triode Unit	Pentode Unit
Plate Supply Voltage .....	200	150	volts
Grid-No.2 Supply Voltage .....	—	100	volts
Grid-No.1 Voltage .....	-2	—	volts
Cathode-Bias Resistor .....	—	180	ohms
Amplification Factor .....	70	—	
Plate Resistance (Approx.) .....	17500	100000	ohms
Transconductance, Grid No.1 to Plate .....	4000	4400	μmhos
Transconductance, Grid No.3 to Plate .....	—	600	μmhos
Plate Current .....	4	4	mA
Grid-No.2 Current .....	—	2.8	mA
Grid-No.1 Voltage (Approx.):			
For plate current of 10 μA .....	-5	—	volts
For plate current of 20 μA .....	—	-4	volts
Grid-No.3 Voltage (Approx.) for plate current of 20 μA .....	—	-7°	volts
MAXIMUM CIRCUIT VALUES		Triode Unit	
Grid-Circuit Resistance:			
For fixed-bias operation .....		0.25	megohms
For cathode-bias operation .....		1	megohms

° With no external connection to triode plate and triode grid.

**Gated AGC Amplifier and Noise Inverter**

For operation in a 525-line, 30-frame system

MAXIMUM RATINGS (Design-Maximum Values)		Pentode Unit	
DC Plate Voltage .....		300	volts
Peak Positive-Pulse Plate Voltage <sup>‡</sup> .....		500	volts
Grid-No.3 (Control-Grid) Voltage:			
Positive-bias value .....		0	volts
Negative-bias value .....		-100	volts
Grid-No.2 (Screen-Grid) Supply Voltage .....		300	volts
Grid-No.2 Voltage .....		See curve page 96	
Grid-No.1 (Control-Grid) Voltage:			
Positive-bias value .....		0	volts
Negative-bias value .....		-50	volts
Plate Dissipation .....		2	watts
Grid-No.2 Input:			
For grid-No.2 voltages up to 150 volts .....		11	watts
For grid-No.2 voltages between 150 and 300 volts .....		See curve page 96	
MAXIMUM CIRCUIT VALUES			
Grid-No.1-Circuit Resistance:			
For fixed-bias operation .....		0.5	megohms
For cathode-bias operation .....		1	megohms

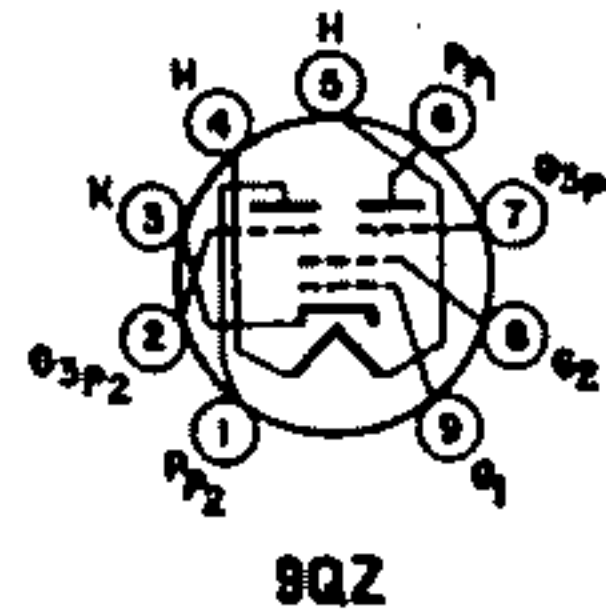
<sup>‡</sup> Pulse duration must not exceed 16% of a horizontal scanning cycle (10 microseconds).

# 6LE8

10LE8, 15LE8

## TWIN PENTODE

Miniature type used as combined color demodulator and matrix amplifier in color television receivers utilizing high-level demodulation systems. Outlines section, 6G; requires miniature 9-contact socket. Types 10LE8 and 15LE8 are identical with type 6LE8 except for heater ratings.



	6LE8	10LE8	15LE8	
Heater Voltage (ac/dc)	6.3	10.0	15.0	volts
Heater Current	0.76	0.45	0.30	ampere
Heater Warm-up Time (Average)	—	11	11	seconds
<b>Heater-Cathode Voltage:</b>				
Peak value	+200, -300 max			volts
Average value	100 max			volts
<b>Direct Interelectrode Capacitances:</b>				
Plate (Each Unit) to All Other Electrodes	2.7			pF
Grid No.1 to All Other Electrodes	15.5			pF
Grid No.3 (Each Unit) to All Other Electrodes	6			pF
Grid No.3 to Plate (Each Unit)	2.7			pF
Grid No.3 (Unit No.1) to Grid No.3 (Unit No.2)	0.1			pF

### Class A<sub>1</sub> Amplifier

#### MAXIMUM RATINGS (Design-Maximum Values)

Plate Voltage (Each Unit)	300	volts
Grid-No.2 (Screen-Grid) Voltage	150	volts
Plate Dissipation (Each Unit)	2	watts
Grid-No.2 Input	2	watts

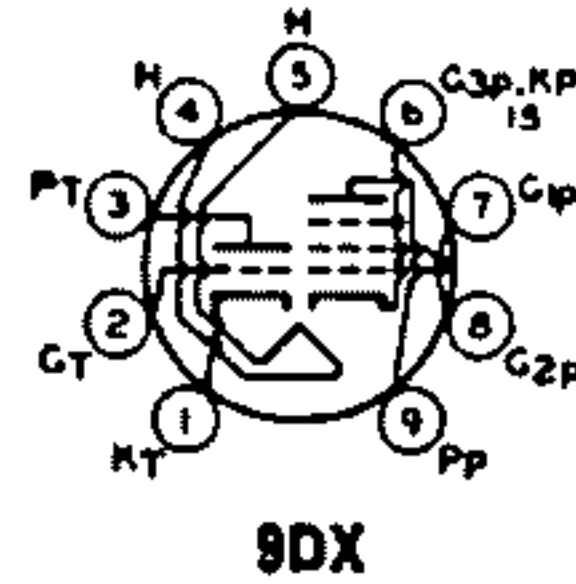
#### CHARACTERISTICS

	G <sub>1</sub> Control	G <sub>2</sub> Control	
Plate Voltage	100	100	volts
Grid-No.3 (Suppressor-Grid) Voltage	0	0	volts
Grid-No.2 Voltage	100	100	volts
Grid-No.1 (Control-Grid) Voltage, Negative-bias value	-2.5	-2.5	volts
Transconductance (Approx.)	5800	350	μmhos
Plate Resistance (Approx.)	50000	50000	ohms
Plate Current	8	7.6	mA
Grid-No.2 Current	15	14.5	mA
Grid-No.1 Voltage for plate current of 20 μA	-7.2	—	volts
Grid-No.1 Voltage for plate current of 100 μA	-6.3	—	volts
Grid-No.3 Voltage for plate current of 20 μA	—	-17.4	volts
Grid-No.3 Voltage for plate current of 100 μA	—	-16.5	volts

# 6LF8

## HIGH-MU TRIODE— SHARP-CUTOFF PENTODE

Miniature type used in video-amplifier stages of color and black-and-white television receivers. Outlines section, 6E; requires miniature 9-contact socket.



Heater Voltage (ac/dc)	6.3	volts
Heater Current	0.6	ampere
Heater Warm-up Time (Average)	11	seconds
<b>Heater-Cathode Voltage:</b>		
Peak value	±200 max	volts
Average value	100 max	volts
<b>Direct Interelectrode Capacitances:</b>		
<b>Triode Unit:</b>		
Grid to Plate	2.2	pF
Grid to Cathode, Heater, Pentode Cathode, Pentode Grid No.3, and Internal Shield	3.2	pF
Plate to Cathode, Heater, Pentode Cathode, Pentode Grid No.3, and Internal Shield	1.8	pF
<b>Pentode Unit:</b>		
Grid No.1 to Plate	0.08 max	pF
Grid No.1 to Cathode, Heater, Grid No.2, Grid No.3, and Internal Shield	10	pF



Plate to Cathode, Heater, Grid No.2, Grid No.3, and Internal Shield .....	3.6	PF
Pentode Grid No.1 to Triode Plate .....	0.008 max	PF
Pentode Plate to Triode Plate .....	0.15 max	PF

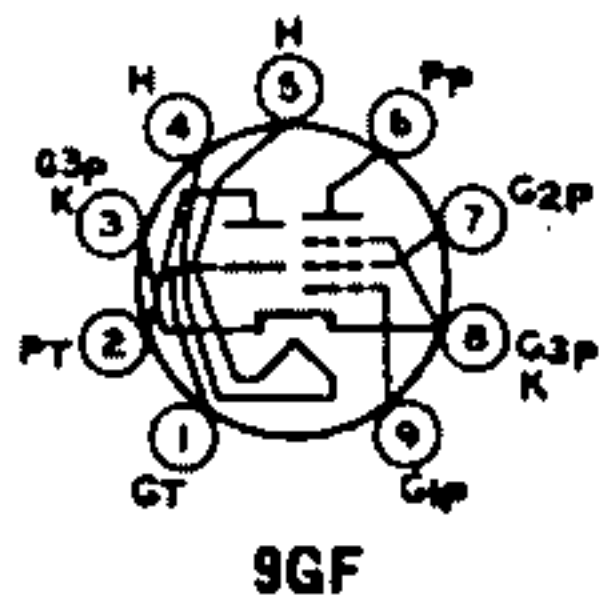
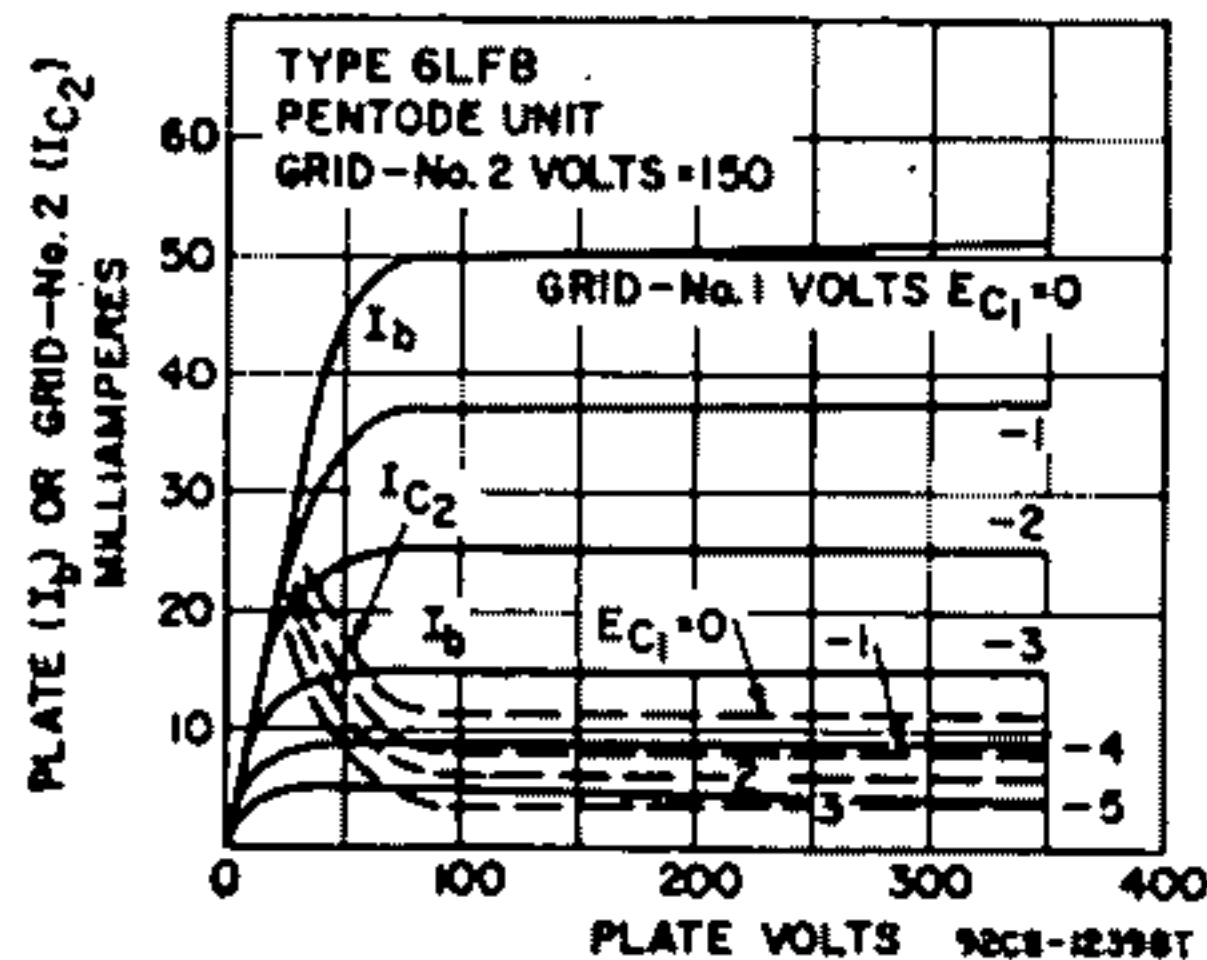
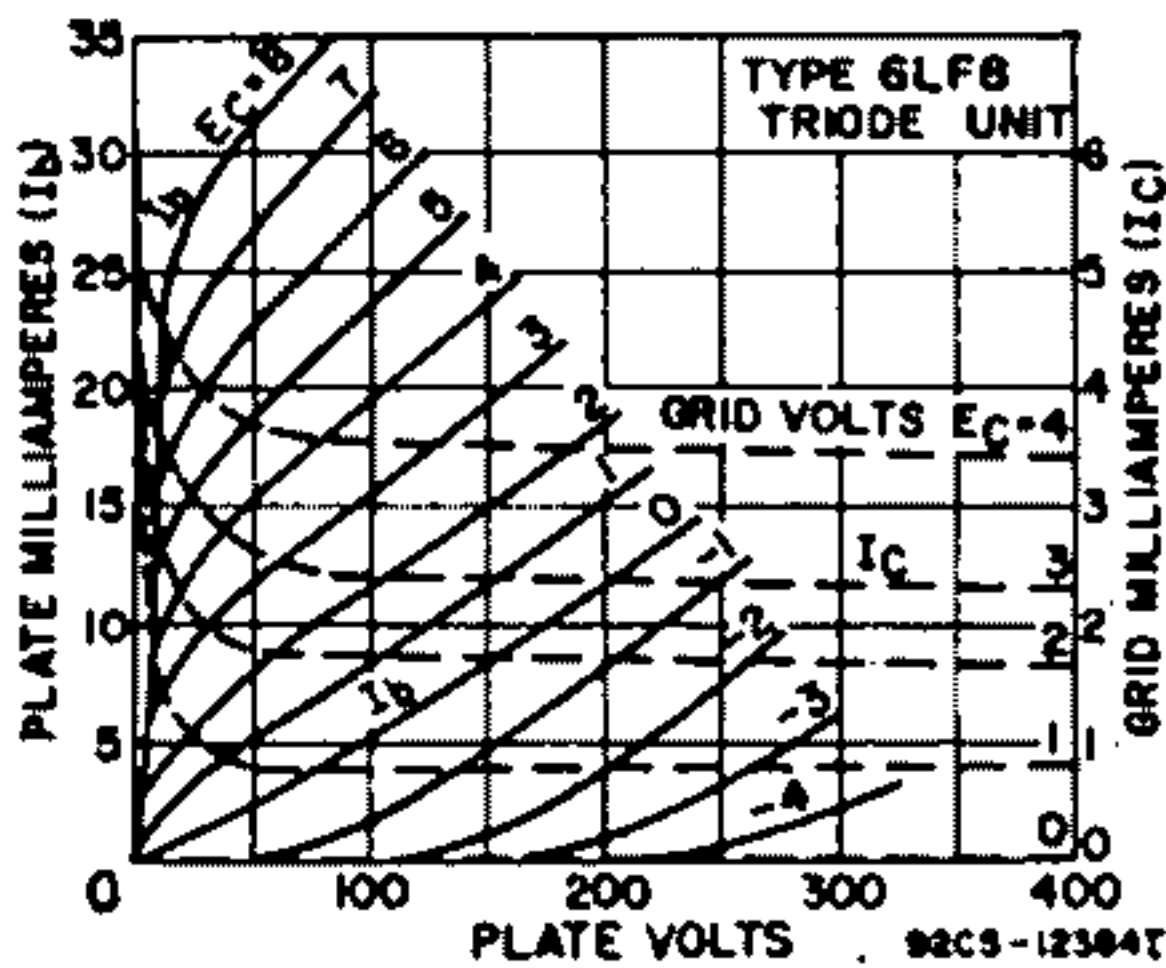
**Class A Amplifier**

MAXIMUM RATINGS (Design-Maximum Values)	Triode Unit	Pentode Unit	
Plate Voltage .....	330	330	volts
Grid-No.2 (Screen-Grid) Supply Voltage .....	—	330	volts
Grid-No.2 Voltage .....	—	See curve page 96	
Grid-No.1 (Control-Grid) Voltage:			
Positive-bias value .....	4	0	volts
Negative-bias value .....	-55	-55	volts
Grid-No.1 Current .....	8	0	mA
Plate Dissipation .....	1.1	3.75	watts
Grid-No.2 Input:			
For grid-No.2 voltages up to 165 volts .....	—	1.1	watts
For grid-No.2 voltages between 165 and 330 volts .....	—	See curve page 96	

CHARACTERISTICS	Triode Unit		Pentode Unit		
Plate Voltage .....	200	40	75	100	volts
Grid-No.2 Voltage .....	—	—	150	150	volts
Grid-No.1 Voltage .....	-2	3	0	-2.5	volts
Amplification Factor .....	70	40	—	—	
Plate Resistance (Approx.) .....	17500	10000	—	200000	ohms
Transconductance .....	4000	4000	—	11000	μmhos
Plate Current .....	4	11	50*	20	mA
Grid-No.2 Current .....	—	—	12*	5	mA
Grid-No.1 Current .....	0	2.7	0	0	mA
Grid-No.1 Voltage (Approx.) for plate current of 20 μA .....	-5	—	—	-8	volts

MAXIMUM CIRCUIT VALUES	Triode Unit	Pentode Unit	
Grid-No.1-Circuit Resistance:			
For fixed-bias operation .....	0.5	0.25	megohm
For cathode-bias operation .....	1	1	megohm

\* This value can be measured by a method involving a recurrent waveform such that the maximum ratings of the tube will not be exceeded.



**MEDIUM-MU TRIODE— SHARP-CUTOFF PENTODE 6LJ8**

Miniature type used as a combined oscillator and mixer in vhf television receivers. Outlines section, 6B; requires 9-contact socket. Heater: volts (ac/dc), 6.3; amperes, 0.4; maximum heater-cathode volts, ±200 peak, 100 average.

**Class A<sub>1</sub> Amplifier**

MAXIMUM RATINGS (Design-Maximum Values)	Triode Unit	Pentode Unit	
Plate Voltage .....	280	280	volts
Grid-No.2 (Screen-Grid) Supply Voltage .....	—	280	volts
Grid-No.2 Voltage .....	—	See curve page 96	

Cathode Current .....	20	20	mA
Grid-No.1 (Control-Grid) Voltage, Positive-bias value .....	0	0	volts
Plate Dissipation .....	2	2	watts
Grid-No.2 Input:			
For grid-No.2 voltages up to 140 volts .....	—	0.5	watts
For grid-No.2 voltages between 140 and 280 volts .....	—	See curve page 96	

**CHARACTERISTICS**

Plate Voltage .....	125	125	volts
Grid-No.2 Voltage .....	—	125	volts
Cathode-Bias Resistor .....	68	33	ohms
Amplification Factor .....	40	—	
Plate Resistance (Approx.) .....	5000	125000	ohms
Transconductance .....	8400	13000	$\mu$ mbos
Plate Current .....	13	12	mA
Grid-No.2 Current .....	—	3.5	mA
Grid-No.1 Voltage (Approx.) for plate current of 30 $\mu$ A .....	—6.5	—4	volts

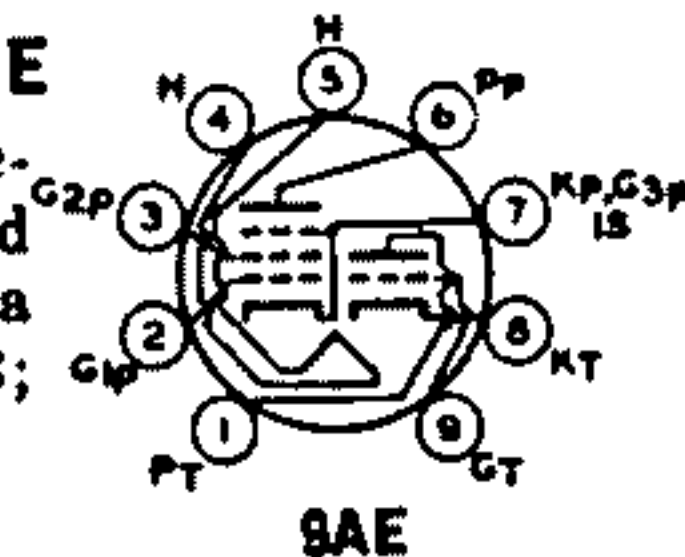
**MAXIMUM CIRCUIT VALUES**

Grid-No.1-Circuit Resistance:			
For fixed-bias operation .....	1	0.5	megohm
For cathode-bias operation .....	0.5	0.25	megohm

**6LM8**

**MEDIUM-MU TRIODE—SEMI-REMOTE-CUTOFF PENTODE**

Miniature type used in color and black-and-white television receiver applications. The pentode unit is used in burst-amplifier circuits, and the triode unit as a general-purpose amplifier tube. Outlines section, 6B; requires miniature 9-contact socket.



Heater Voltage (ac/dc) .....	6.3	volts
Heater Current .....	0.45	ampere
Heater-Cathode Voltage:		
Peak value .....	$\pm$ 200 max	volts
Average value .....	100 max	volts
Direct Interelectrode Capacitances:		
Triode Unit:		
Grid to Plate .....	1.8	pF
Grid to Cathode, Heater, Pentode Cathode, Pentode Grid No.3, and Internal Shield .....	3.2	pF
Plate to Cathode, Heater, Pentode Cathode, Pentode Grid No.3, and Internal Shield .....	1.9	pF
Pentode Unit:		
Grid No.1 to Plate .....	0.015 max	pF
Grid No.1 to Cathode, Heater, Grid No.2, Grid No.3, and Internal Shield .....	5.5	pF
Plate to Cathode, Heater, Grid No.2, Grid No.3, and Internal Shield .....	3.8	pF
Heater to Cathode (Each Unit) .....	3.2	pF

**Class A<sub>1</sub> Amplifier**

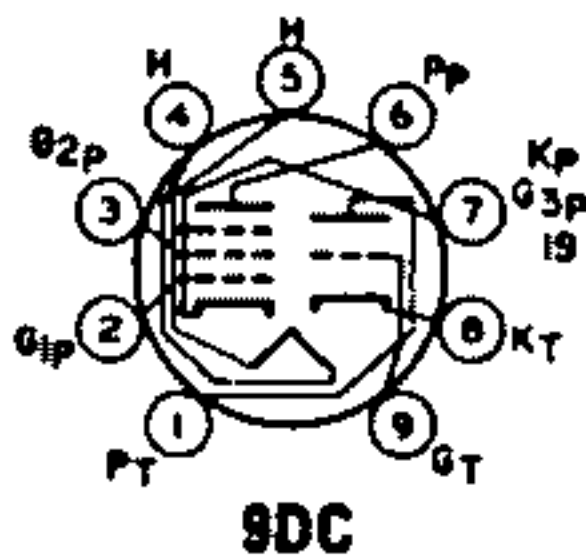
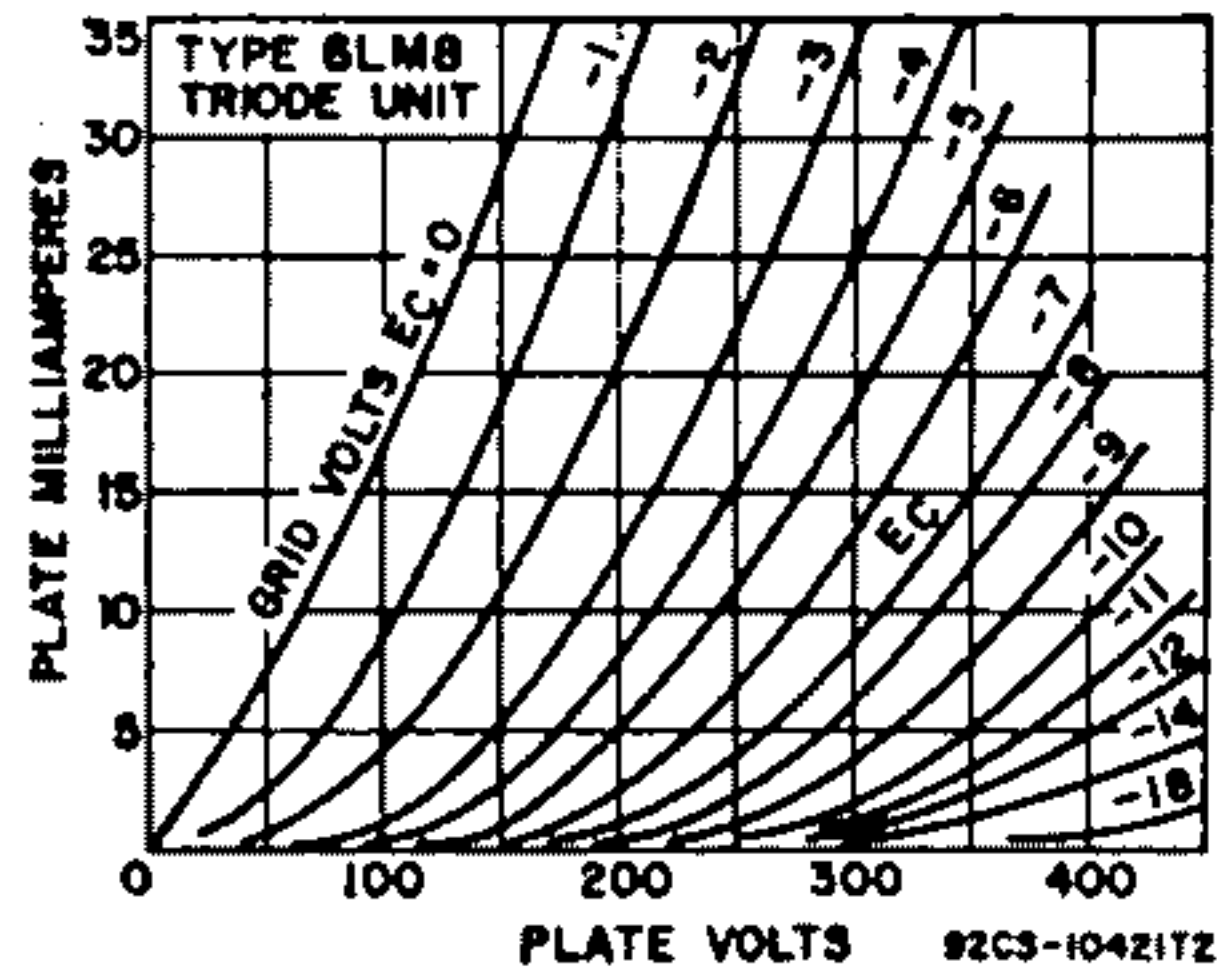
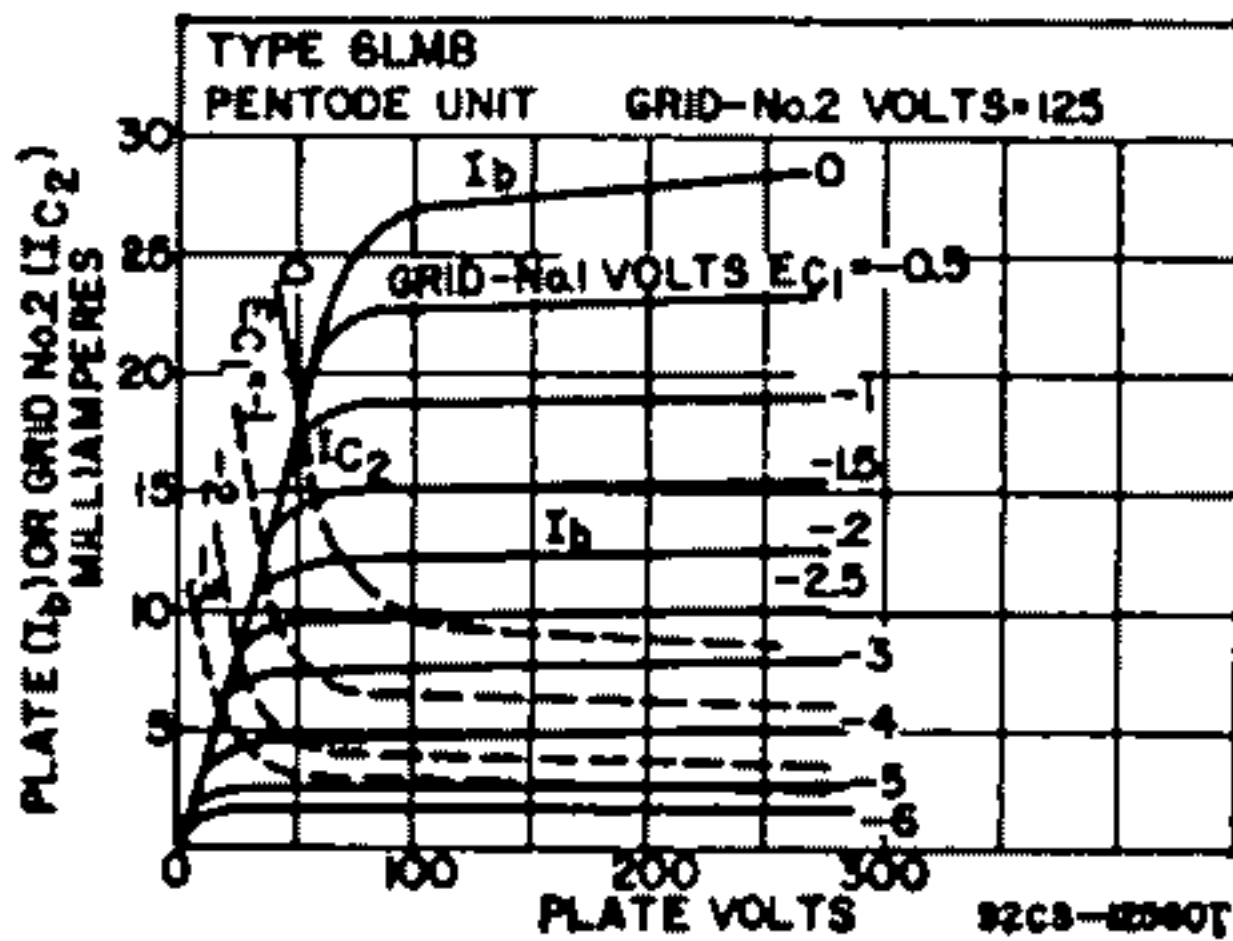
<b>MAXIMUM RATINGS (Design-Maximum Values)</b>	<b>Triode Unit</b>	<b>Pentode Unit</b>	
Plate Voltage .....	330	350	volts
Grid-No.2 (Screen-Grid) Supply Voltage .....	—	330	volts
Grid-No.2 Voltage .....	—	See curve page 96	
Grid-No.1 (Control-Grid) Voltage, Positive-bias value .....	0	0	volts
Plate Dissipation .....	2.5	2.5	watts
Grid-No.2 Input:			
For grid-No.2 voltages up to 165 volts .....	—	0.55	watts
For grid-No.2 voltages between 165 and 330 volts .....	—	See curve page 96	

**CHARACTERISTICS**

Plate Voltage .....	125	125	volts
Grid-No.2 Voltage .....	—	125	volts
Grid No.1 Voltage .....	—1	—2	volts
Amplification Factor .....	46	—	
Plate Resistance (Approx.) .....	5400	150000	ohms
Transconductance .....	8500	6000	$\mu$ mbos
Plate Current .....	13.5	12	mA
Grid-No.2 Current .....	—	4	mA
Grid-No.1 Voltage (Approx.) for plate current of 10 $\mu$ A .....	—8	—14	volts

**MAXIMUM CIRCUIT VALUES**

Grid-No.1-Circuit Resistance:			
For fixed-bias operation .....	0.5	0.25	megohm
For cathode-bias operation .....	1	0.5	megohm



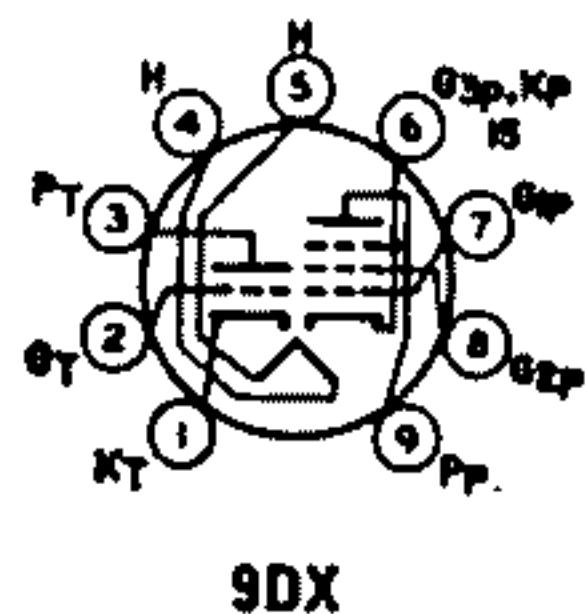
**MEDIUM-MU TRIODE—  
SHARP-CUTOFF PENTODE** **6LN8**

Miniature type used in frequency-changer service in television receivers. Outlines section, 6B; requires miniature 9-contact socket.

Heater Voltage (ac/dc)	6.0	volts
Heater Current	0.45	ampere
Peak Heater-Cathode Voltage	±100 max	volts

**Class A<sub>1</sub> Amplifier**

MAXIMUM RATINGS (Design-Maximum Values)	Triode Unit	Pentode Unit	
Plate Supply Voltage	550	550	volts
Plate Voltage	250	250	volts
Grid-No.2 (Screen-Grid) Supply Voltage	—	550	volts
Grid-No.2 Voltage:			
With cathode current of 14 mA	—	175	volts
With cathode current less than 10 mA	—	200	volts
Cathode Current	14	14	mA
Plate Dissipation	1.5	1.7	watts
Grid-No.2 Input:			
With plate dissipation greater than 1.2 watts	—	0.5	watt
With plate dissipation less than 1.2 watts	—	0.75	watt
<b>CHARACTERISTICS</b>			
Plate Voltage	100	170	volts
Grid-No.2 Voltage	—	170	volts
Grid-No.1 Voltage	-2	-2	volts
Amplification Factor	20	—	
Mu-Factor, Grid No.2 to Grid No.1	—	47	
Plate Resistance (Approx.)	—	0.4	megohm
Transconductance	5000	6200	μmhos
Plate Current	14	10	mA
Grid-No.2 Current	—	2.8	mA
Input Resistance at frequency of 50 MHz	—	0.01	megohm
Equivalent Noise Resistance	—	1500	ohms
<b>MAXIMUM CIRCUIT VALUES</b>			
Grid-No.1-Circuit Resistance:			
For fixed-bias operation	0.5	0.5	megohm
For cathode-bias operation	0.5	1	megohm



**MEDIUM-MU TRIODE—  
SHARP-CUTOFF PENTODE** **6LQ8**

Miniature type used in color and black-and-white television receiver applications. The pentode unit is used as a video output tube. The triode unit is used in sync separator and sound-if circuits. Outlines section, 6E; requires miniature 9-contact socket.



Heater Voltage (ac/dc) .....	6.8	volts
Heater Current .....	0.7	ampere
Heater-Cathode Voltage:		
Peak value .....	±200 max	volts
Average value .....	100 max	volts
Direct Interelectrode Capacitances:		
Triode Unit:		
Grid to Plate .....	2.8	pF
Grid to Triode Cathode, Pentode Cathode, Heater, Pentode		
Grid No.3, and Internal Shield .....	4.2	pF
Plate to Triode Cathode, Pentode Cathode, Heater, Pentode		
Grid No.3, and Internal Shield .....	2.4	pF
Pentode Unit:		
Grid No.1 to Plate .....	0.12 max	pF
Grid No.1 to Cathode Heater, Grid No.2, Grid No.3, and		
Internal Shield .....	14	pF
Plate to Cathode, Heater, Grid No.2, Grid No.3, and		
Internal Shield .....	4.8	pF
Triode Grid to Pentode Plate .....	0.015 max	pF
Pentode Plate to Triode Plate .....	0.17 max	pF

**Class A<sub>1</sub> Amplifier**

**MAXIMUM RATINGS (Design-Maximum Values)**

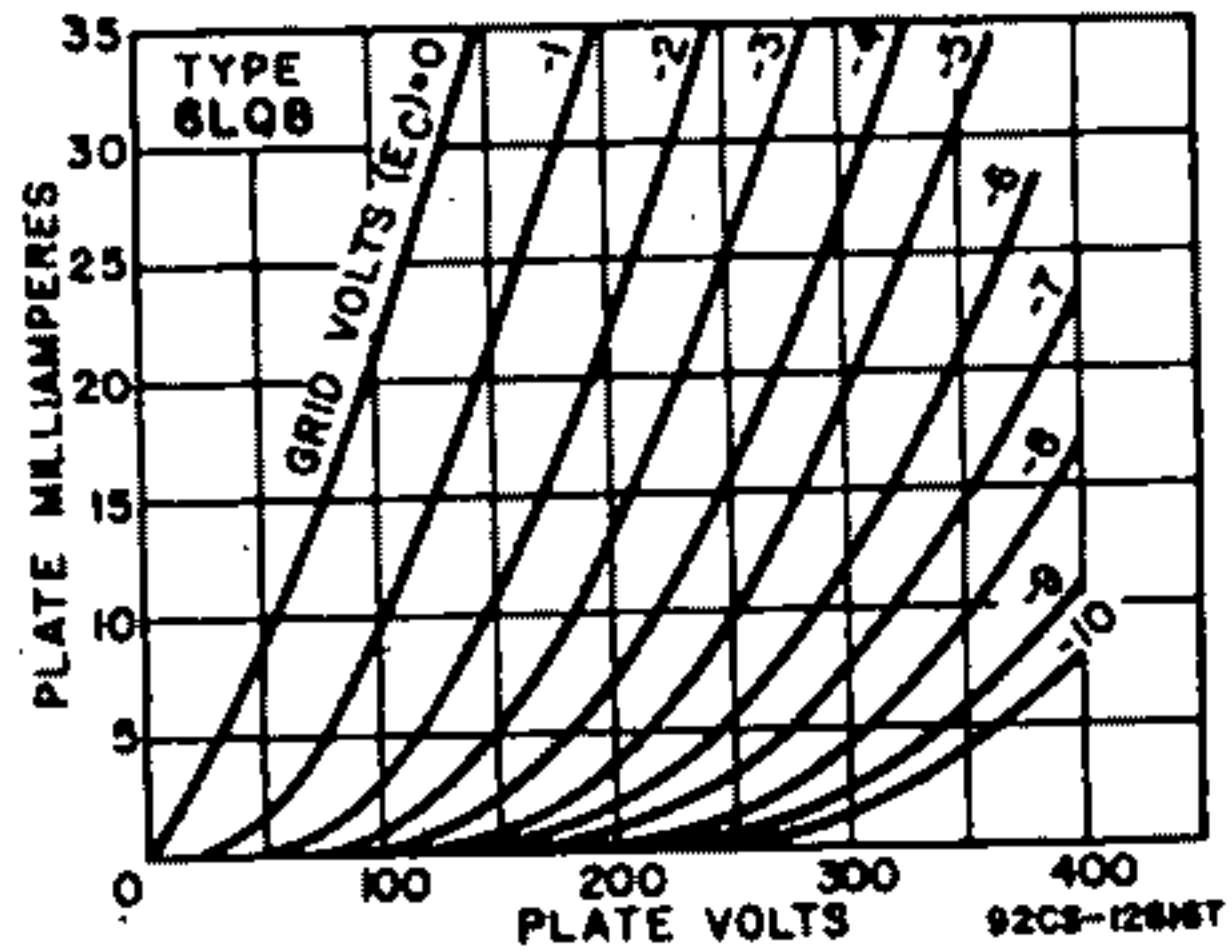
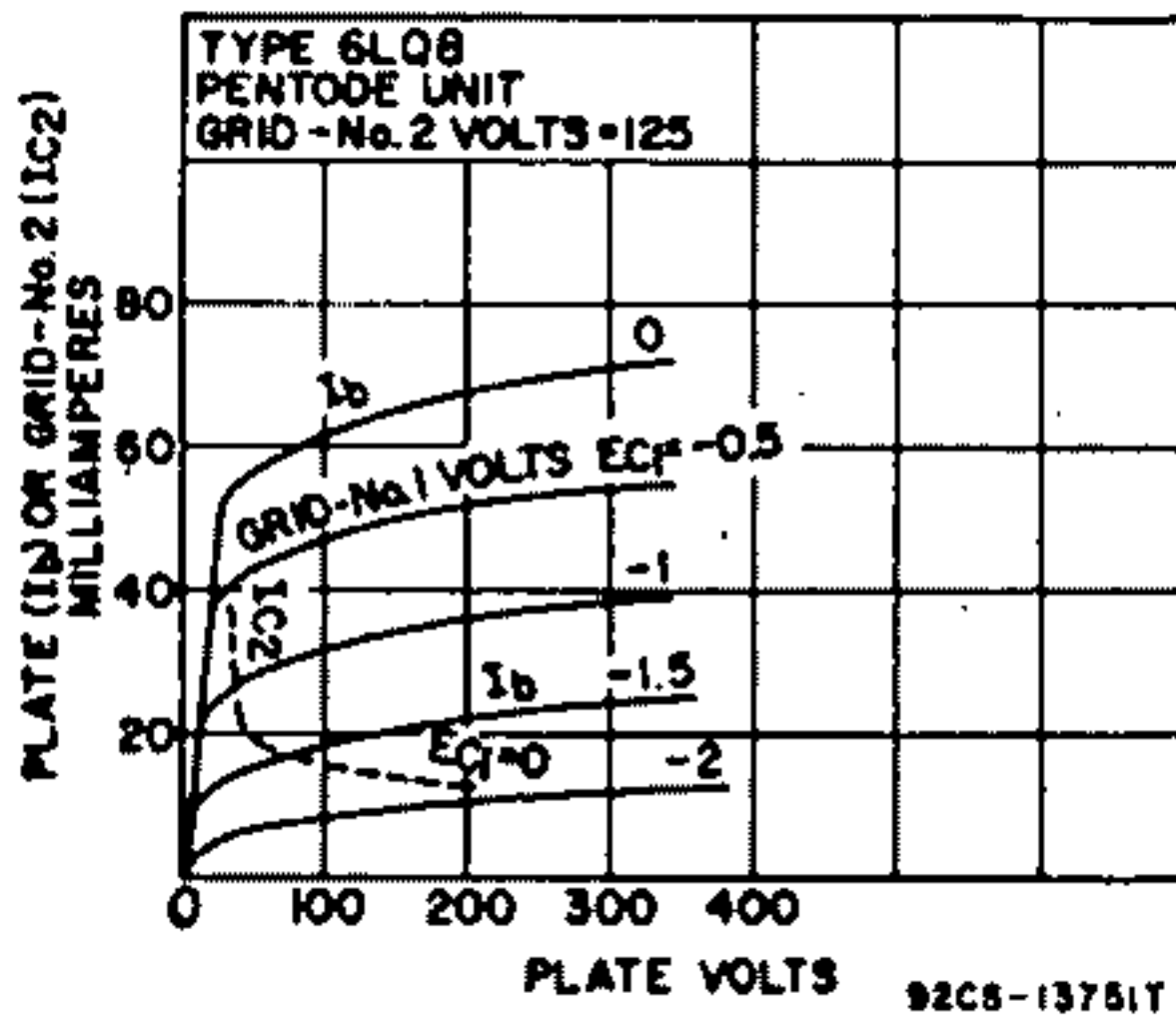
	Triode Unit	Pentode Unit	
Plate Voltage .....	300	300	volts
Grid-No.2 (Screen-Grid) Supply Voltage .....	—	300	volts
Grid-No.2 Voltage .....	—	See curve page 96	
Grid-No.1 (Control-Grid) Voltage, Positive-bias value .....	0	0	volts
Plate Dissipation .....	2	5	watts
Grid-No.2 Input:			
For grid-No.2 voltages up to 150 volts .....	—	1	watts
For grid-No.2 voltages between 150 and 300 volts .....	—	See curve page 96	

**CHARACTERISTICS**

	Triode Unit	Pentode Unit	
Plate Supply Voltage .....	125	125	volts
Grid-No.2 Supply Voltage .....	—	125	volts
Cathode-Bias Resistor .....	68	82	ohms
Amplification Factor .....	46	—	
Plate Resistance (Approx.) .....	4400	55000	ohms
Transconductance .....	10400	21000	μmhos
Plate Current .....	15	16.5	mA
Grid-No.2 Current .....	—	3.1	mA
Grid-No.1 Voltage (Approx.) for plate current			
of 100 μA .....	-6	-4.2	volts

**MAXIMUM CIRCUIT VALUES**

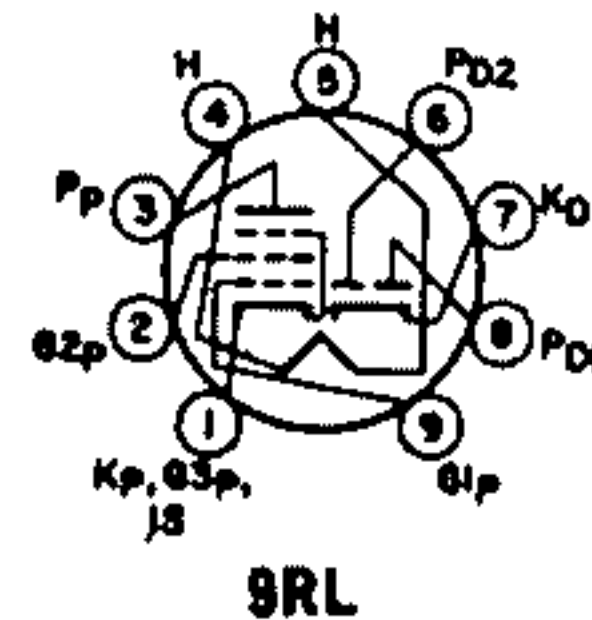
	Triode Unit	Pentode Unit	
Grid-No.1-Circuit Resistance:			
For fixed-bias operation .....	0.5	0.1	megohm
For cathode-bias operation .....	1	0.25	megohm



**6LT8**  
8LT8

**TWIN DIODE—  
SHARP-CUTOFF PENTODE**

Miniature type used in television receiver applications. The pentode unit is used in low-frequency horizontal-oscillator applications. The diode units are used in horizontal afc discriminator circuits. Outlines section, 6B; requires miniature 9-contact socket. Type 8LT8 is identical with type 6LT8 except for heater ratings.



	6LT8	8LT8	
Heater Voltage .....	6.3	8.1	volts
Heater Current .....	0.6	0.45	ampere
Heater Warm-up Time (Average) .....	11	11	seconds
Heater-Cathode Voltage:			
Peak value .....	±200 max	±200 max	volts
Average value .....	100 max	100 max	volts

**Pentode Unit as Class A<sub>1</sub> Amplifier**

**MAXIMUM RATINGS (Design-Maximum Values)**

Plate Voltage .....	330	volts
Grid-No.2 (Screen-Grid) Supply Voltage .....	330	volts
Grid-No.2 Voltage .....	See curve page 96	
Grid-No.1 (Control-Grid) Voltage, Positive-bias value .....	0	volts
Plate Dissipation .....	3.1	watts
Grid-No.2 Input:		
For grid-No.2 voltages up to 165 volts .....	0.65	watt
For grid-No.2 voltages between 165 and 33 volts .....	See curve page 96	

**CHARACTERISTICS**

Plate Voltage .....	125	volts
Grid No.3 (Suppressor Grid) .....	Connected to ground	
Grid-No.2 Voltage .....	125	volts
Cathode-Bias Resistor .....	56	ohms
Plate Resistance (Approx.) .....	200000	ohms
Transconductance .....	13000	μmbos
Plate Current .....	10	mA
Grid-No.2 Current .....	3.4	mA
Grid-No.1 Voltage (Approx.) for plate current of 20 μA .....	-3.5	volts

**MAXIMUM CIRCUIT VALUES**

Grid-No.1-Circuit Resistance, for cathode-bias operation .....	1.0	megohm
--	-----	--------

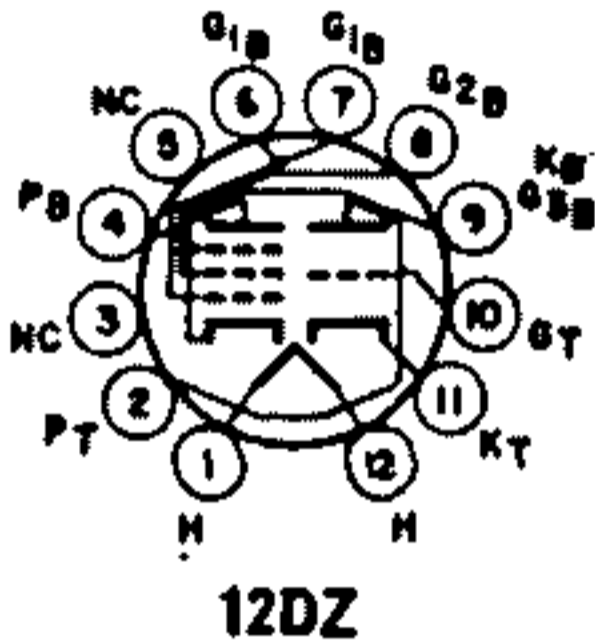
**Diode Unit (Each Unit)**

**MAXIMUM RATINGS (Design-Maximum Values)**

Plate Current (Continuous Operation) .....	5	mA
--	---	----

**CHARACTERISTICS, Instantaneous Value**

Tube Voltage Drop for plate current of 20 mA .....	5	volts
--	---	-------



**MEDIUM-MU TRIODE—  
BEAM POWER TUBE**

**6LU8**

Duodecar type used as a combined vertical-deflection oscillator and vertical-deflection amplifier in color television receivers. Outlines section, 15D; requires duodecar 12-contact socket. Heater: volts, 6.3; amperes, 1.5; maximum heater-cathode volts, ±200 peak, 100 average.

**Class A<sub>1</sub> Amplifier**

**CHARACTERISTICS**

	Triode Unit	Beam Power Unit			
Plate Voltage .....	250	45	135	120	volts
Grid-No.2 (Screen-Grid) Voltage .....	—	125	120	120*	volts
Grid-No.1 (Control-Grid) Voltage .....	—4	0	-10	-10	volts
Amplification Factor .....	58	—	—	6.5	
Plate Resistance (Approx.) .....	16000	—	12000	—	ohms
Transconductance .....	3600	—	9300	—	μmbos
Plate Current .....	2.3	200**	56	—	mA
Grid-No.1 Voltage (Approx.):	—	20**	3	—	mA
Grid-No.1 Voltage (Approx.):					
For plate current of 10 μA .....	-6.6	—	—	—	volts
For plate current of 100 μA .....	—	—	-30	—	volts
For plate current of 1 mA .....	—	—	-26	—	volts

\* Triode connection, Grid No.2 connected to plate at socket.

\*\* This value can be measured by a method involving a recurrent waveform such that the maximum ratings of the tube will not be exceeded.

**Vertical-Deflection Oscillator and Amplifier**

For operation in a 525-line, 30-frame system

**MAXIMUM RATINGS (Design-Maximum Values)**

	Triode Unit Oscillator	Beam Power Unit Amplifier	
Plate Voltage .....	400	400	volts
Grid-No.2 Voltage .....	—	300	volts
Peak Positive-Pulse Plate Voltage* .....	—	3500	volts
Peak Negative-Pulse Grid-No.1 Voltage .....	-400	-250	volts
Plate Dissipation* .....	2.5	14	watts
Peak Cathode Current .....	105	260	mA

Average Cathode Current .....	30	75	mA
Grid-No.2 Input .....	—	2.75	watts
Bulb Temperature (At hottest point) .....	—	210	°C

**MAXIMUM CIRCUIT VALUES**

Grid-Circuit Resistance:			
For fixed-bias operation .....	—	1.0	megohm
For cathode-bias operation .....	2.2	2.2	megohms

# Pulse duration must not exceed 15% of a horizontal scanning cycle (10 microseconds).  
 \* A bias resistor or other means is required to protect the tube in absence of excitation.

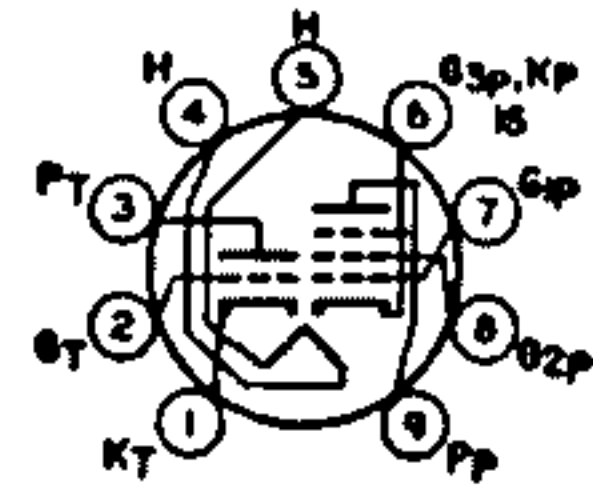
**6LX8/LCF802**

Refer to types 6JW8 and 6JW8/ECF802.

**6LY8**

**HIGH-MU TRIODE—  
SHARP-CUTOFF PENTODE**

Miniature type used in color and black-and-white television receiver applications. The pentode unit is used as a video amplifier, and the triode unit for general-purpose use. Outlines section, 6E; requires 9-contact socket. Heater: volts (ac/dc), 6.3; amperes, 0.75; maximum heater-cathode volts, ±200 peak, 100 average.



9DX

**Class A<sub>1</sub> Amplifier**

**MAXIMUM RATINGS (Design-Maximum Values)**

	Triode Unit	Pentode Unit	
Plate Voltage .....	330	330	volts
Grid-No.2 (Screen-Grid) Supply Voltage .....	—	330	volts
Grid-No.2 Voltage .....	—	See curve page 96	
Grid-No.1 (Control-Grid) Voltage, Positive-bias value .....	0	0	volts
Plate Dissipation .....	1.0	5.0	watts
Grid-No.2 Input:			
For grid-No.2 voltages up to 165 volts .....	—	1.1	watts
For grid-No.2 voltages between 165 and 330 volts .....	—	See curve page 96	

**CHARACTERISTICS**

Plate Voltage .....	250	35	200	volts
Grid-No.2 Voltage .....	—	100	100	volts
Grid-No.1 Voltage .....	—2.0	0	—	volts
Cathode-Bias Resistor .....	—	—	82	ohms
Amplification Factor .....	100	—	—	
Plate Resistance (Approx.) .....	59000	—	60000	ohms
Transconductance .....	1700	—	20000	μmhos
Plate Current .....	1.8	54	19.5	mA
Grid-No.2 Current .....	—	18.5	3.0	mA
Grid Voltage (Approx.) for plate current of 10 μA .....	—6	—	—	volts
Grid-No.1 Voltage (Approx.) for plate current of 100 μA .....	—	—	—6.3	volts

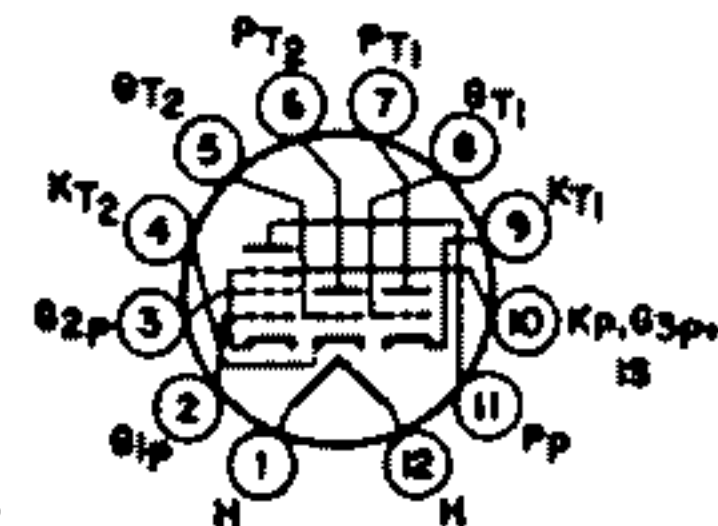
**MAXIMUM CIRCUIT VALUES**

Grid-No.1-Circuit Resistance:			
For fixed-bias operation .....	0.5	0.5	megohm
For cathode-bias operation .....	1.0	1.0	megohm

**6M11**

**HIGH-MU TWIN TRIODE—  
SHARP-CUTOFF PENTODE**

Duodecar type used in television receiver applications. The triode units are used in sync-separator and agc-amplifier circuits; the pentode unit is used in if-amplifier circuits. Outlines section, 8B; requires duodecar 12-contact socket.



12CA

Heater Voltage (ac/dc) .....	6.3	volts
Heater Current .....	0.77	ampere
Heater-Cathode Voltage:		
Peak value .....	±200 max	volts
Average value .....	100 max	volts
Direct Interelectrode Capacitances:**		
Triode Units:		
Grid to Plate .....	1.8	pF

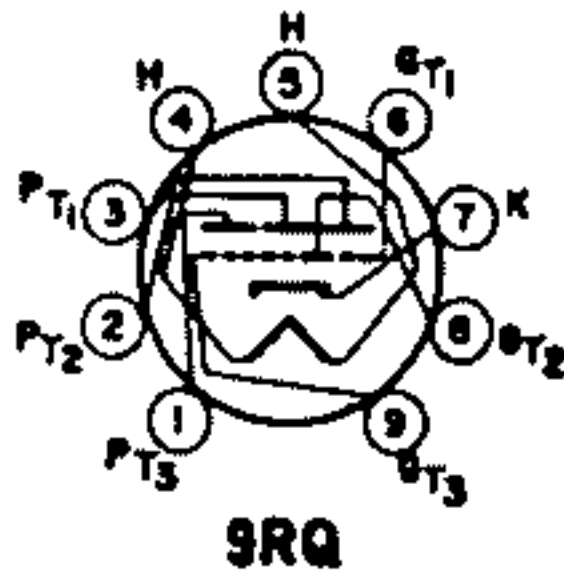


Grid to Triode Cathode, Pentode Cathode, Heater, Pentode Grid No.3, and Internal Shield	2.4	pF
Plate to Triode Cathode, Pentode Cathode, Heater, Pentode Grid No.3, and Internal Shield	0.8	pF
Pentode:		
Grid No.1 to Plate	0.08	pF
Grid No.1 to Cathode, Grid No.2, Grid No.3, and Internal Shield	12	pF
Plate to Cathode, Grid No.2, Grid No.3, and Internal Shield	2.8	pF

\*\* With external shield connected to pentode cathode, grid No.3, and internal shield.

**Class A<sub>1</sub> Amplifier**

MAXIMUM RATINGS (Design-Maximum Values)	Each		
	Triode Unit	Pentode Unit	
Plate Voltage	330	330	volts
Grid-No.2 (Screen-Grid) Supply Voltage	—	330	volts
Grid-No.2 Voltage	—	See curve page 96	
Grid-No.1 (Control-Grid) Voltage, Positive-bias value	0	0	volts
Plate Dissipation	2.25	3.1	watts
Grid-No.2 Input:			
For voltages up to 165 volts	—	0.65	watt
For voltages between 165 and 330 volts	—	See curve page 96	
<b>CHARACTERISTICS</b>			
Plate Supply Voltage	125	125	volts
Grid-No.2 Supply Voltage	—	125	volts
Cathode-Bias Resistor	125	56	ohms
Amplification Factor	58	—	
Plate Resistance (Approx.)	7250	200000	ohms
Transconductance	8000	13000	μmhos
Plate Current	8	11	mA
Grid-No.2 Current	—	3.4	mA
Grid-No.1 Voltage (Approx.) for plate current of 20 μA	—	—3.5	volts
Grid-No.1 Voltage (Approx.) for plate current of 50 μA	—4.5	—	volts
<b>MAXIMUM CIRCUIT VALUES</b>			
Grid-No.1-Circuit Resistance, for cathode-bias operation	0.68	1	megohm



**MEDIUM-MU TRIPLE TRIODE**

**6MD8**

Novar type used in matrixing circuits of color and black-and-white television receivers. Outlines section, 11E; requires novar 9-contact socket.

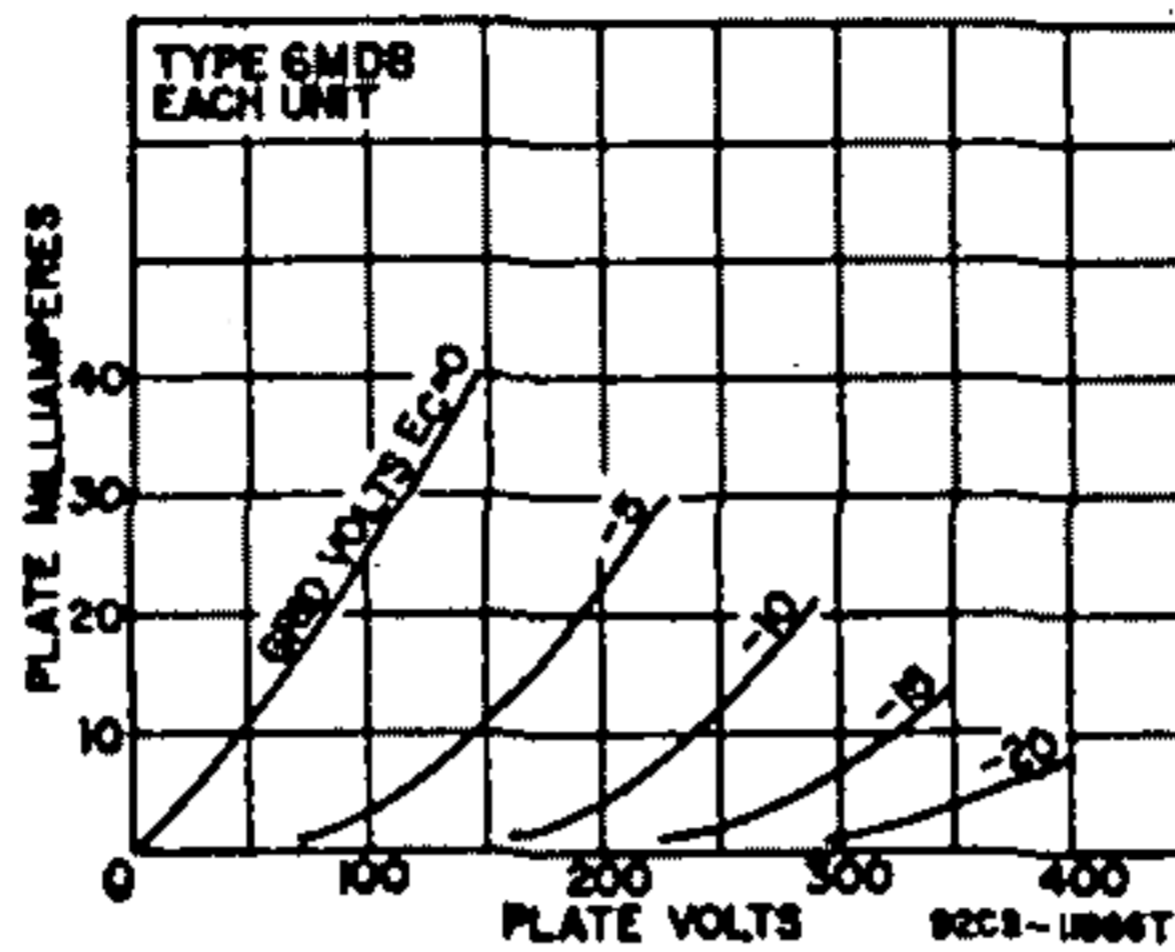
Heater Voltage (ac/dc)	6.3	volts	
Heater Current	0.9	ampere	
Heater-Cathode Voltage:			
Peak value	±200 max	volts	
Average value	100 max	volts	
	Unit No.1	Unit No.2	Unit No.3
Direct Interelectrode Capacitances (Approx.):			
Grid to Plate	3	3	3
Grid to Cathode and Heater	3.6	3.6	3.4
Plate to Cathode and Heater	0.48	0.48	0.36

**Class A<sub>1</sub> Amplifier (Each Unit)**

MAXIMUM RATINGS (Design-Maximum Values)		
Plate Voltage	330	volts
Grid Voltage, Positive-bias value	0	volts
Plate Dissipation	3	watts
<b>CHARACTERISTICS</b>		
Plate Voltage	250	volts
Grid Voltage	—10.5	volts
Amplification Factor	17	
Plate Resistance (Approx.)	5500	ohms
Transconductance	3100	μmhos
Plate Current	11.5	mA
Plate Current for grid voltage of —14 volts	4	mA
Grid Voltage (Approx.) for plate current of 50 μA	—23	volts

**MAXIMUM CIRCUIT VALUE**

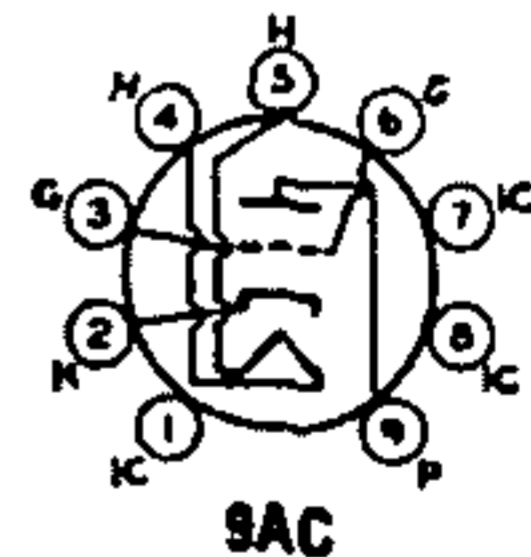
Grid-Circuit Resistance, for fixed-bias operation ..... 1 megohm



- 6N6G** Refer to chart at end of section.
- 6N7** Refer to chart at end of section.
- 6N7GT** Refer to chart at end of section.
- 6P5GT** Refer to chart at end of section.
- 6P7G** Refer to chart at end of section.
- 6Q7** Refer to chart at end of section.
- 6Q7G** Refer to chart at end of section.
- 6Q7GT** Refer to chart at end of section.
- 6Q11** Refer to chart at end of section.
- 6R7** Refer to chart at end of section.
- 6R7G** Refer to chart at end of section.
- 6R7GT** Refer to chart at end of section.
- 6S4** Refer to chart at end of section.

**6S4A MEDIUM-MU TRIODE**

Miniature type used as vertical-deflection amplifier in color and black-and-white television receivers. Outlines section, 6E; requires miniature 9-contact socket.



Heater Voltage (ac/dc) .....	6.8	volts
Heater Current .....	0.6	ampere
Heater Warm-up Time (Average) .....	11	seconds
Heater-Cathode Voltage:		
Peak value .....	±200 max	volts
Average value .....	100 max	volts
Direct Interelectrode Capacitances (Approx.):		
Grid to Plate .....	2.4	pF
Grid to Cathode and Heater .....	4.2	pF
Plate to Cathode and Heater .....	0.6	pF

**Class A<sub>1</sub> Amplifier**

<b>CHARACTERISTICS</b>		
Plate Voltage .....	250	volts

Grid Voltage .....	-8	volts
Amplification Factor .....	16.5	
Plate Resistance (Approx.) .....	8700	ohms
Transconductance .....	4600	μmhos
Plate Current .....	24	mA
Plate Current for grid voltage of -15 volts .....	4	mA
Grid Voltage (Approx.) for plate current of 50 μA .....	-22	volts

**Vertical-Deflection Amplifier**

For operation in a 525-line, 30-frame system

**MAXIMUM RATINGS (Design-Maximum Values)**

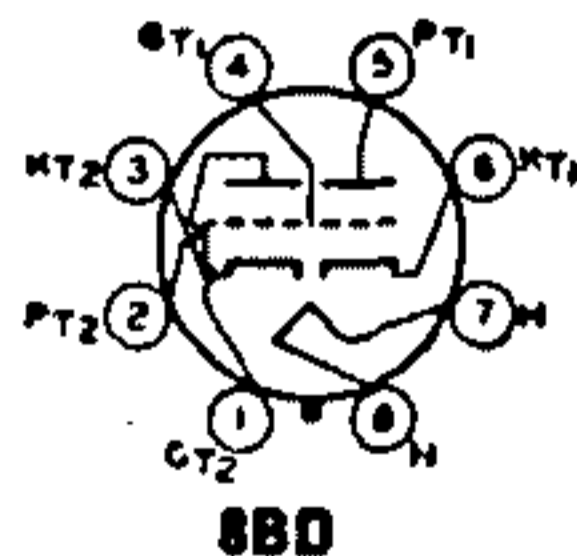
DC Plate Voltage .....	550	volts
Peak Positive-Pulse Plate Voltage# .....	2200	volts
Peak Negative-Pulse Grid Voltage .....	-250	volts
Peak Cathode Current .....	105	mA
Average Cathode Current .....	30	mA
Plate Dissipation .....	8.6	watts

**MAXIMUM CIRCUIT VALUE**

Grid-Circuit Resistance, for cathode-bias operation .....	2.2	megohms
---	-----	---------

# Pulse duration must not exceed 15% of a vertical scanning cycle (2.5 milliseconds).

Refer to chart at end of section.	<b>6S7</b> <b>6S7G</b>
Refer to chart at end of section.	<b>6S8GT</b>
Refer to chart at end of section.	<b>6SA7</b> <b>6SA7GT</b>
Refer to chart at end of section.	<b>6SB7Y</b>
Refer to chart at end of section.	<b>6SC7</b>
Refer to chart at end of section.	<b>6SF5</b> <b>6SF5GT</b>
Refer to chart at end of section.	<b>6SF7</b>
Refer to chart at end of section.	<b>6SG7</b>
Refer to chart at end of section.	<b>6SH7</b>
Refer to chart at end of section.	<b>6SJ7</b> <b>6SJ7GT</b>
Refer to chart at end of section.	<b>6SK7</b> <b>6SK7GT</b>



**HIGH-MU TWIN TRIODE**

**6SL7GT**

12SL7GT

Glass octal type used as phase inverter in radio equipment. Each unit may also be used in resistance-coupled amplifier circuits. Outlines section, 18D; requires octal socket. Except for the common heater, each triode unit is independent of the other. For typical operation as

phase inverter or resistance-coupled amplifier, refer to Resistance-Coupled Amplifier section. Type 12SL7GT is identical with type 6SL7GT except for heater ratings.

Heater Voltage (ac/dc) .....	6SL7GT 6.8	12SL7GT 12.6	volts
Heater Current .....	0.8	0.16	ampere
Peak Heater-Cathode Voltage .....	±90 max	±90 max	volts



Direct Interelectrode Capacitances (Approx.):	Unit No.1	Unit No.2	
Grid to Plate .....	2.8	2.8	pF
Grid to Cathode and Heater .....	3.0	3.4	pF
Plate to Cathode and Heater .....	3.8	3.2	pF

\* With external shield connected to cathode.

**Class A<sub>1</sub> Amplifier**

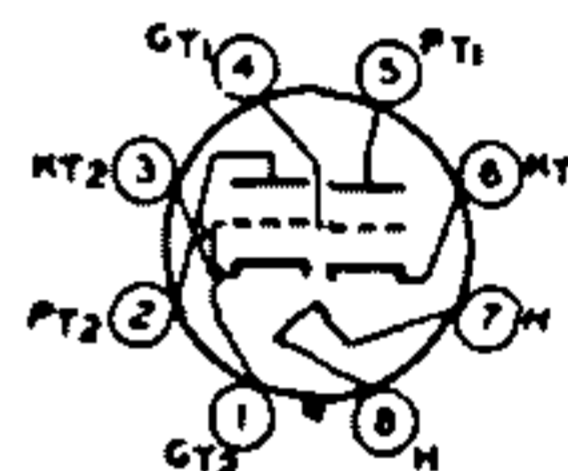
<b>MAXIMUM RATINGS (Design-Center Values)</b>			
Plate Voltage .....	300		volts
Grid Voltage, Positive-bias value .....	0		volts
Plate Dissipation .....	1		watt
<b>CHARACTERISTICS</b>			
Plate Voltage .....	250		volts
Grid Voltage .....	-2		volts
Amplification Factor .....	70		
Plate Resistance (Approx.) .....	44000		ohms
Transconductance .....	1600		μmhos
Plate Current .....	2.3		mA

**6SN7GT**  
**6SN7GTA**

Refer to chart at end of section.

**6SN7GTB MEDIUM-MU TWIN TRIODE**  
**12SN7GTA**

Glass octal type used as combined vertical oscillator and vertical-deflection amplifier, and as horizontal-deflection oscillator, in color and black-and-white television receivers. Each unit may also be used in multi-vibrator or resistance-coupled amplifier circuits in radio equipment. Outlines section, 13D; requires octal socket. Except for the common heater, each triode unit is independent of the other. For typical operation as resistance-coupled amplifier, refer to Resistance-Coupled Amplifier section. Type 12SN7GTA is identical with type 6SN7GTB except for heater ratings.



**88D**

	<b>6SN7GTB</b>	<b>12SN7GTA</b>	
Heater Voltage (ac/dc) .....	6.3	12.6	volts
Heater Current .....	0.6	0.3	ampere
Heater Warm-up Time (Average) .....	11	—	seconds
Heater-Cathode Voltage:			
Peak value .....	±200 max	±200 max	volts
Average value .....	100 max	100 max	volts
Direct Interelectrode Capacitances (Approx.):	Unit No.1	Unit No.2	
Grid to Plate .....	4.0	3.8	pF
Grid to Cathode and Heater .....	2.2	2.6	pF
Plate to Cathode and Heater .....	0.7	0.7	pF

**Class A<sub>1</sub> Amplifier (Each Unit)**

<b>MAXIMUM RATINGS (Design-Center Values)</b>			
Plate Voltage .....	450		volts
Cathode Current .....	20		mA
Plate Dissipation:			
For either plate .....	5		watts
For both plates with both units operating .....	7.5		watts
<b>CHARACTERISTICS</b>			
Plate Voltage .....	90	250	volts
Grid Voltage .....	0	-8	volts
Amplification Factor .....	20	20	
Plate Resistance (Approx.) .....	6700	7700	ohms
Transconductance .....	3000	2600	μmhos
Plate Current .....	10	9	mA
Plate Current for grid voltage of -12.5 volts .....	—	1.3	mA
Grid Voltage (Approx.) for plate current of 10 μA ..	-7	-18	volts
<b>MAXIMUM CIRCUIT VALUE</b>			
Grid-Circuit Resistance, for fixed-bias operation .....	1.0		megohms

**Oscillator (Each Unit)**

For operation in a 525-line, 30-frame system

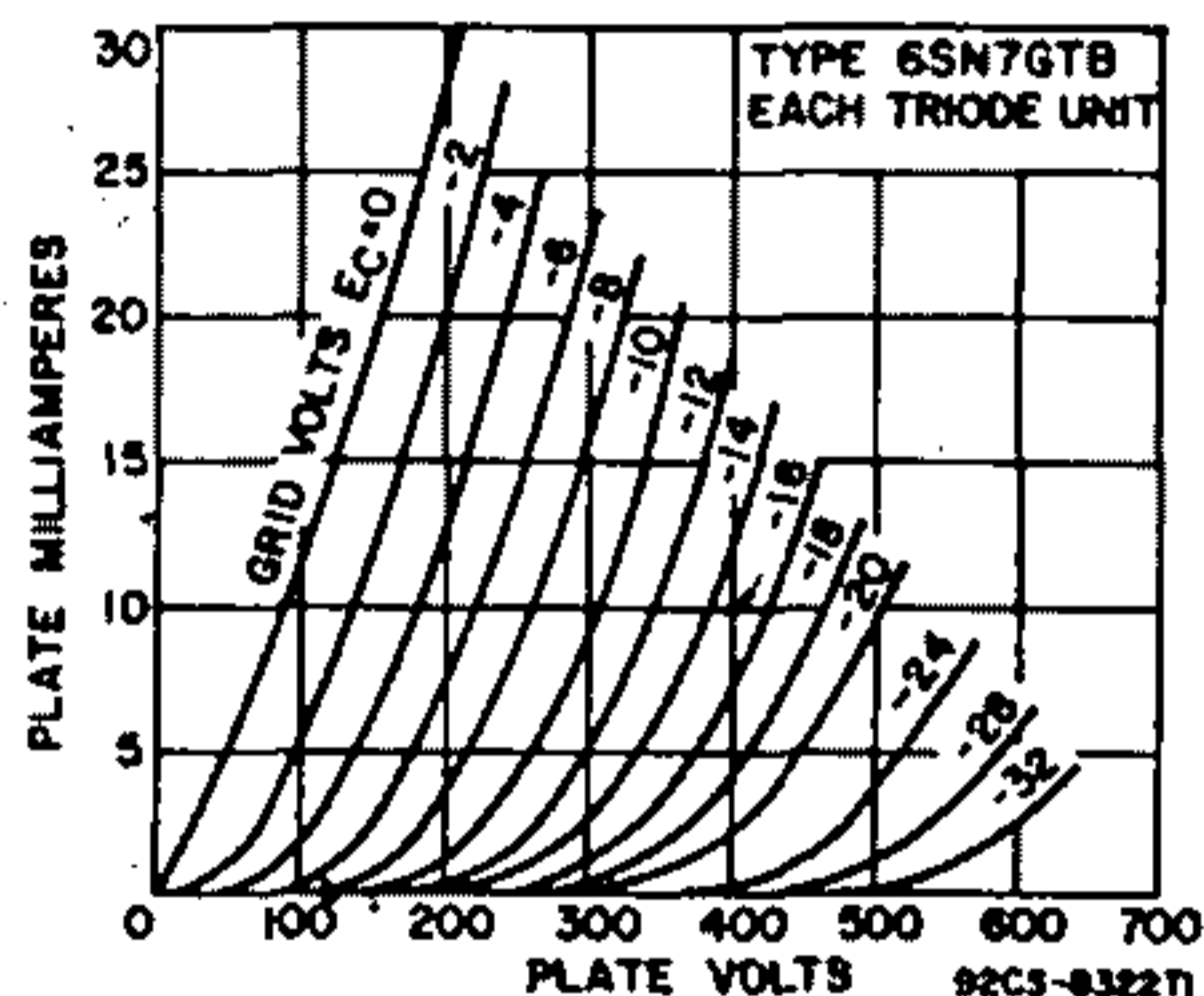
	Vertical-Deflection Oscillator	Horizontal-Deflection Oscillator	
<b>MAXIMUM RATINGS (Design-Center Values)</b>			
DC Plate Voltage .....	450	450	volts
Peak Negative-Pulse Grid Voltage .....	-400	-600	volts
Peak Cathode Current .....	70	300	mA
Average Cathode Current .....	20	20	mA
Plate Dissipation:			
For either plate .....	5	5	watts
For both plates with both units operating .....	7.5	7.5	watts
<b>MAXIMUM CIRCUIT VALUES</b>			
Grid-Circuit Resistance .....	2.2	2.2	megohms

**Vertical Deflection Amplifier (Each Unit)**

For operation in a 525-line, 30-frame system

<b>MAXIMUM RATINGS (Design-Center Values)</b>			
DC Plate Voltage .....		450	volts
Peak Positive-Pulse Plate Voltage* (Absolute maximum) .....		1500*	volts
Peak Negative-Pulse Grid Voltage .....		-250	volts
Peak Cathode Current .....		70	mA
Average Cathode Current .....		20	mA
Plate Dissipation:			
For either plate .....		5	watts
For both plates with both units operating .....		7.5	watts
<b>MAXIMUM CIRCUIT VALUE</b>			
Grid-Circuit Resistance, for cathode-bias operation .....		2.2	megohms

\* Pulse duration must not exceed 15% of a vertical cycle (2.5 milliseconds).  
 \* Under no circumstances should this absolute value be exceeded.



Refer to chart at end of section.

**6SQ7  
6SQ7GT**

Refer to chart at end of section.

**6SR7**

Refer to chart at end of section.

**6SS7**

Refer to chart at end of section.

**6ST7**

Refer to chart at end of section.

**6SZ7**

Refer to chart at end of section.

**6T4**

Refer to chart at end of section.

**6T7G**

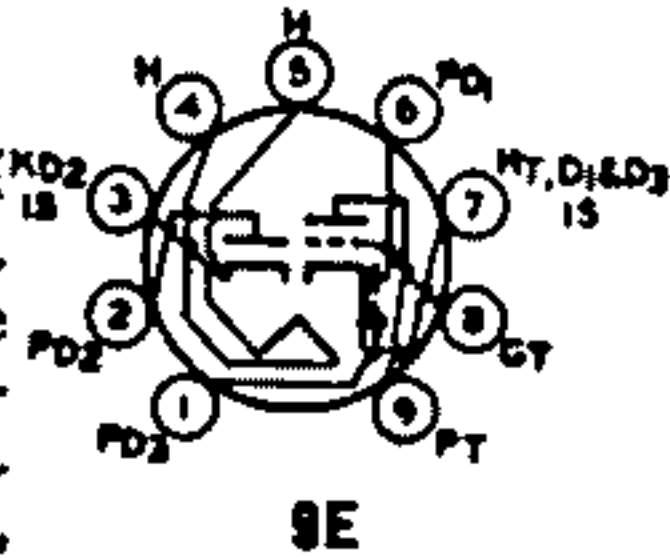
Refer to chart at end of section.

**6T8**

**6T8A**  
5T8

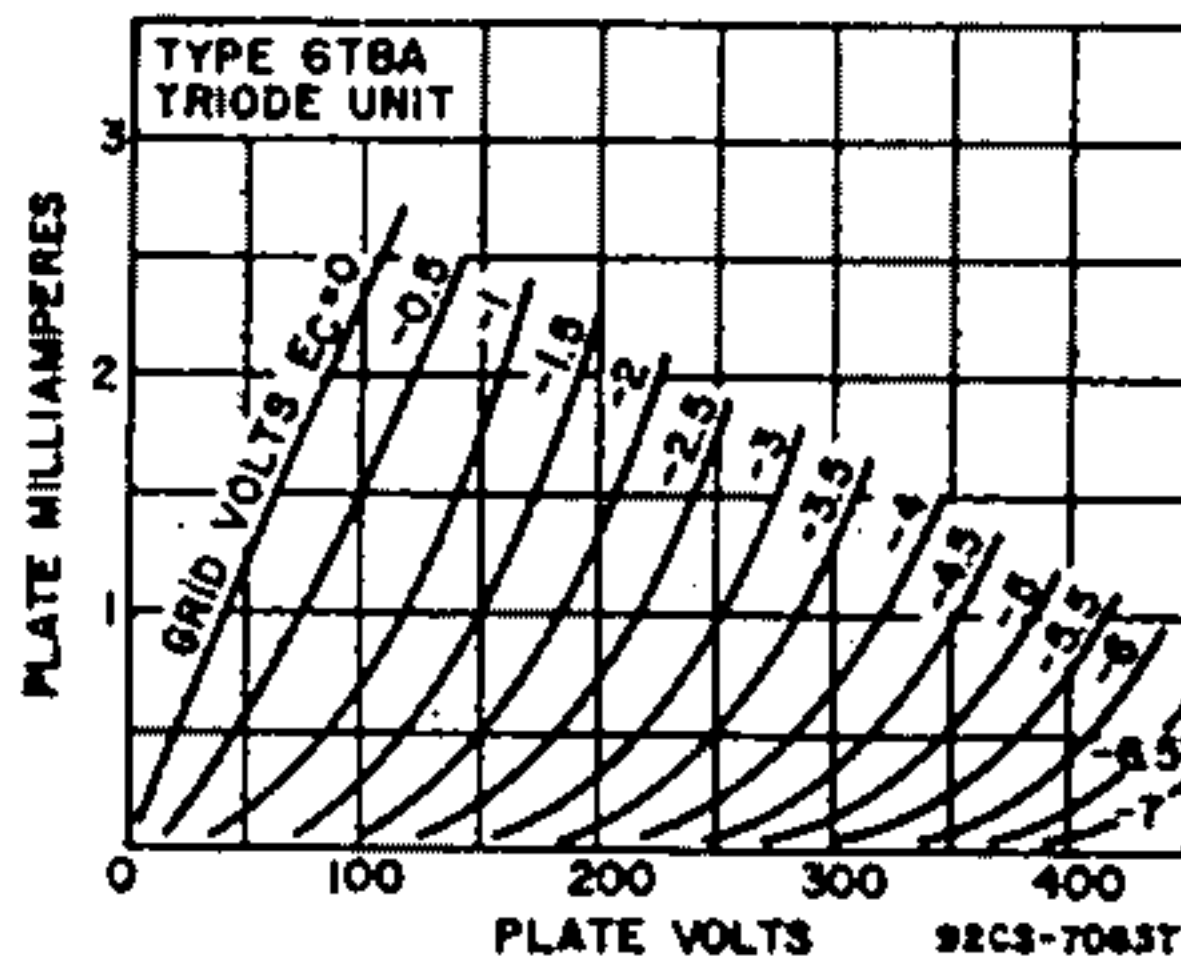
**TRIPLE DIODE—  
HIGH-MU TRIODE**

Miniature type used as combined audio amplifier, AM<sup>NO2</sup> detector, and FM detector in AM/FM radio receivers. Diode unit No.1 is used for AM detection, and diode units No.2 and No.3 are used for FM detection. Outlines section, 6B; requires miniature 9-contact socket. For typical operation as resistance-coupled amplifier, refer to Resistance-Coupled Amplifier section. Type 5T8 is identical with type 6T8A except for heater ratings.



	5T8	6T8A	
Heater Voltage (ac/dc)	4.7	6.3	volts
Heater Current	0.6	0.45	ampere
Heater Warm-up Time (Average)	11	11	seconds
Heater-Cathode Voltage:			
Peak value	±200 max	±100 max	volts
Average value	100 max	—	volts
Direct Interelectrode Capacitances:	Unshielded	Shielded	
Triode Unit:			
Grid to Plate	1.7	1.7	pF
Grid to Cathode, Internal Shield (pin 7), and Heater	1.6	1.7	pF
Plate to Cathode, Internal Shield (pin 7), and Heater	1.2	2.4	pF
Diode Units:			
Diode-No.1 Plate to Cathode, Internal Shield (pin 7), and Heater	3.8	3.8	pF
Diode-No.2 Plate to Cathode, Internal Shield (pin 3), and Heater	3.8	3.8*	pF
Diode-No.3 Plate to Cathode, Internal Shield (pin 7), and Heater	3.4	3.6	pF
Diode-No.2 Cathode, Internal Shield (pin 3) to All Other Electrodes, and Heater	7.5	8.5=	pF
Triode Grid to any Diode Plate	0.034 max	0.084 max	pF

- With external shield connected to pin 7 except as noted.
- With external shield connected to pin 3.
- With external shield connected to pins 4 and 5.



**Triode Unit as Class A<sub>1</sub> Amplifier**

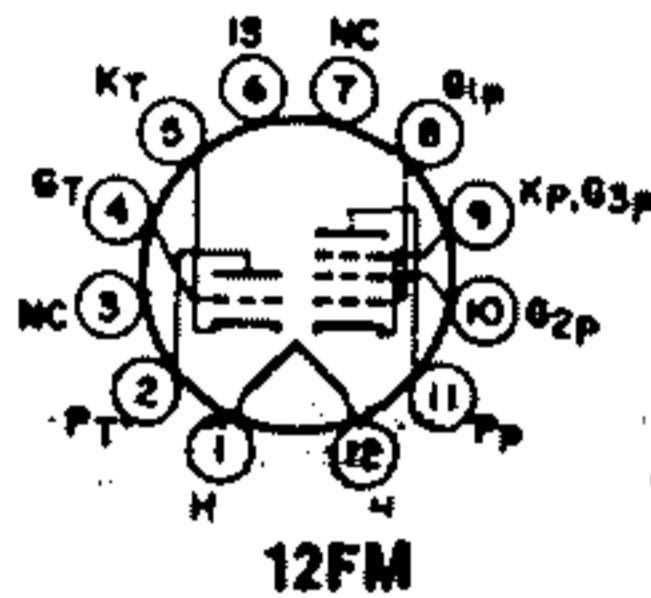
MAXIMUM RATINGS (Design-Maximum Values)			
Plate Voltage		330	volts
Grid Voltage, Positive-bias value		0	volts
Plate Dissipation		1.1	watts
CHARACTERISTICS			
Plate Voltage	100	250	volts
Grid Voltage	-1	-3	volts
Amplification Factor	70	70	



Plate Resistance (Approx.) .....	54000	58000	ohms
Transconductance .....	1800	1200	μmhos
Plate Current .....	0.8	1.0	mA

**Diode Units**

<b>MAXIMUM RATINGS (Design-Maximum Values)</b>			
Plate Current (Each Unit) .....		5.5	mA



**TRIPLE DIODE—  
HIGH-MU TRIODE**

**6T9**

Duodecar type used in audio-frequency circuits. The triode unit is used as a voltage amplifier; the pentode unit is used as a power amplifier. Outlines section, 8B; requires duodecar 12-contact socket.

Heater Voltage (ac/dc) .....	6.3	volts
Heater Current .....	0.93	ampere
<b>Heater-Cathode Voltage:</b>		
Peak value .....	±200 max	volts
Average value .....	100 max	volts
<b>Direct Interelectrode Capacitances:</b>		
<b>Pentode Section:</b>		
Grid No.1 to Plate .....	0.2	pF
Grid No.1 to Cathode, Heater, Grid No.2, Grid No.3, and Internal Shield .....	11	pF
Plate to Cathode, Heater, Grid No.2, Grid No.3, and Internal Shield .....	11	pF
<b>Triode Unit:</b>		
Grid to Plate .....	2.6	pF
Grid to Cathode, Heater, and Internal Shield .....	3.4	pF
Plate to Cathode, Heater, and Internal Shield .....	1.1	pF

**Class A<sub>1</sub> Amplifier**

<b>MAXIMUM RATINGS (Design-Maximum Values)</b>		<b>Triode Unit</b>	<b>Pentode Unit</b>	
Plate Voltage .....	300	275		volts
Grid-No.2 (Screen-Grid) Voltage .....	—	275		volts
Grid-No.1 (Control-Grid) Voltage, Positive-bias value .....	0	0		volts
Plate Dissipation .....	1.5	12		watts
Grid-No.2 Input .....	—	2		watts

**CHARACTERISTICS (Triode Unit)**

Plate Voltage .....	250	volts
Grid Voltage .....	—2	volts
Amplification Factor .....	95	
Plate Resistance (Approx.) .....	45000	ohms
Transconductance .....	2100	μmhos
Plate Current .....	1.5	mA

**TYPICAL OPERATION (Pentode Unit)**

Plate Voltage .....	250	volts
Grid-No.2 Voltage .....	250	volts
Grid-No.1 Voltage .....	—8	volts
Peak AF Grid-No.1 Voltage .....	8	volts
Zero-Signal Plate Current .....	35	mA
Maximum-Signal Plate Current .....	39	mA
Zero-Signal Grid-No.2 Current .....	2.5	mA
Maximum-Signal Grid-No.2 Current .....	7	mA
Plate Resistance (Approx.) .....	0.1	megohm
Transconductance .....	6500	μmhos
Load Resistance .....	5000	ohms
Total Harmonic Distortion (Approx.) .....	10	per cent
Maximum-Signal Power Output .....	4.2	watts

**MAXIMUM CIRCUIT VALUES**

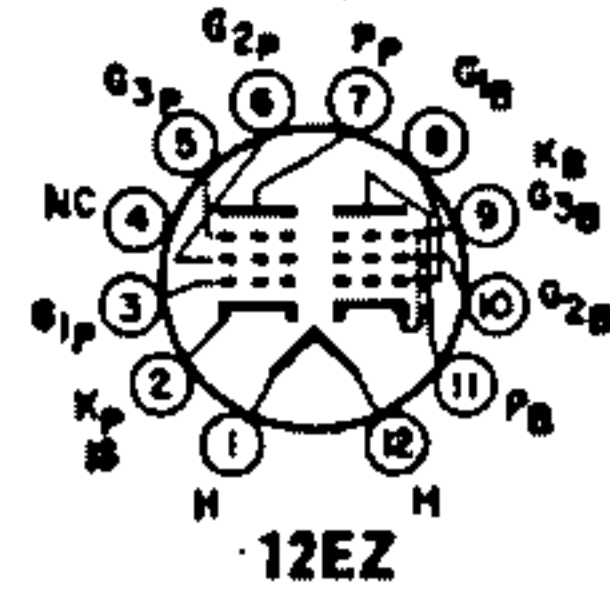
<b>Grid-No.1-Circuit Resistance:</b>		<b>Triode Unit</b>	<b>Pentode Unit</b>	
For fixed-bias operation .....	0.5	0.25		megohm
For cathode-bias operation .....	1*	0.5		megohm

\* For cathode-bias operation of the triode unit, a maximum resistance of 10 megohms can be used provided the plate dissipation never exceeds 0.25 watt.

# 6T10

## BEAM POWER TUBE— SHARP-CUTOFF PENTODE

Duodecar type used as combined FM detector and audio-frequency output amplifier in color and black-and-white television receivers. The beam power unit is used in af output stages, and the sharp-cutoff, dual-control pentode unit is used as an FM detector. Outlines section, 8C; requires duodecar 12-contact socket. For maximum ratings and characteristics, refer to type 6AL11.



Heater Voltage (ac/dc)	6.3	volts
Heater Current	0.96	amperes
Heater-Cathode Voltage		
Peak value	±200 max	volts
Average value	100 max	volts
Direct Interelectrode Capacitances:		
Unit No.1:		
Grid No.1 to Plate	0.22	pF
Grid No.1 to Cathode, Heater, Grid No.2, Grid No.3, and Internal Shield	11	pF
Plate to Cathode, Heater, Grid No.2, Grid No.3, and Internal Shield	10	pF
Unit No.2:		
Grid No.1 to Plate	0.032	pF
Grid No.3 to Plate	8	pF
Grid No.1 to Cathode, Heater, Grid No.2, Grid No.3 and Internal Shield	6.5	pF
Grid No.3 to Cathode, Heater, Grid No.1, Grid No.2, Plate, and Internal Shield	7.5	pF
Grid No.1 to Grid No.3	0.12	pF
Plate of Unit No.1 to Plate of Unit No.2	0.13	pF

**6U5**

Refer to chart at end of section.

**6U7G**

Refer to chart at end of section.

**6U8**

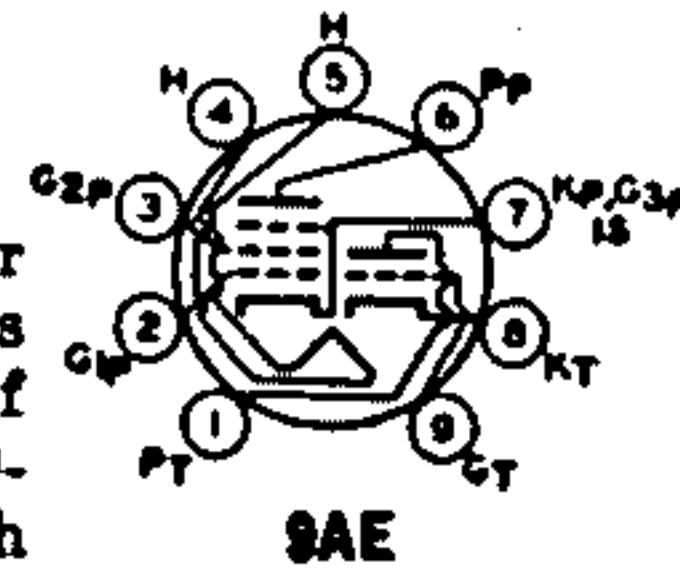
Refer to chart at end of section.

# 6U8A

5U8, 9U8A

## MEDIUM-MU TRIODE— SHARP-CUTOFF PENTODE

Miniature type used as combined oscillator and mixer tube in color and black-and-white television receivers utilizing an intermediate frequency in the order of 40 MHz. Outlines section, 6B; requires miniature 9-contact socket. Types 5U8 and 9U8A are identical with type 6U8A except for heater ratings.



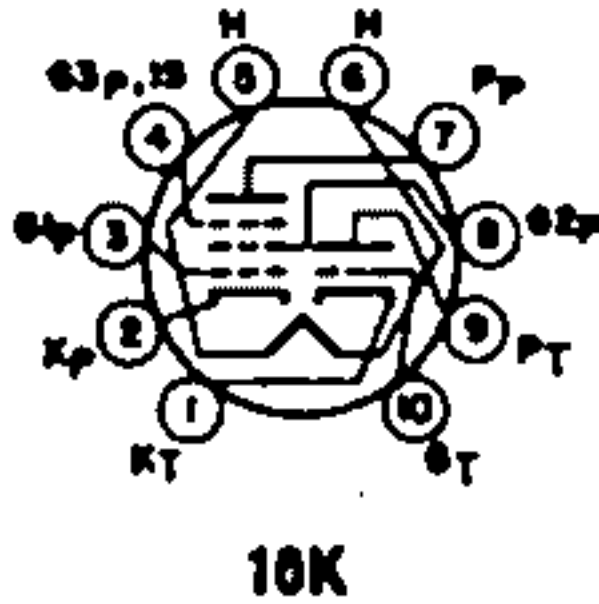
Heater Voltage (ac/dc)	5U8 4.7	6U8A 6.3	9U8A 9.45	volts
Heater Current	0.6	0.45	0.3	ampere
Heater Warm-up Time (Average)	11	11	11	seconds
Heater-Cathode Voltage:				
Peak value	±200 max	±200 max	±200 max	volts
Average value	100 max	100 max	100 max	volts
Direct Interelectrode Capacitances:				
Triode Unit:				
Grid to Plate	1.8	1.8		pF
Grid to Cathode, Heater, Pentode Cathode, Pentode Grid No.3, and Internal Shield	2.8	2.8		pF
Plate to Cathode, Heater, Pentode Cathode, Pentode Grid No.3, and Internal Shield	1.6	2		pF
Pentode Unit:				
Grid No.1 to Plate	0.010 max	0.006 max		pF
Grid No.1 to Cathode, Heater, Grid No.2, Grid No.3, and Internal Shield	5.0	5.0		pF
Plate to Cathode, Heater, Grid No.2, Grid No.3, and Internal Shield	2.6	3.5		pF

Triode Cathode to Heater .....	3	3*	pF
Pentode Cathode, Pentode Grid No.3, and Internal Shield .....	3	3*	pF
Pentode Grid No.1 to Triode Plate .....	0.2 max	0.2 max	pF
Pentode Plate to Triode Plate .....	0.1 max	0.02 max	pF

\* With external shield connected to pin 4 except as noted.  
 \* With external shield connected to pin 6.

**Class A, Amplifier**

MAXIMUM RATINGS (Design-Maximum Values)		Triode Unit	Pentode Unit	
Plate Voltage		220	220	volts
Grid-No.2 (Screen-Grid) Supply Voltage		—	220	volts
Grid-No.2 Voltage		—	See curve page 96	
Grid-No.1 (Control-Grid) Voltage, Positive-bias value		0	0	volts
Plate Dissipation		2.6	2	watts
Grid-No.2 Input:				
For grid-No.2 voltages up to 165 volts		—	0.55	watt
For grid-No.2 voltages between 165 and 220 volts		—	See curve page 96	
CHARACTERISTICS				
Plate Voltage		125	125	volts
Grid-No.2 Voltage		—	110	volts
Grid-No.1 Voltage		—1	—1	volts
Amplification Factor		40	—	
Plate Resistance (Approx.)		—	0.2	megohms
Transconductance		7500	5000	μmhos
Plate Current		18.5	9.5	mA
Grid-No.2 Current		—	3.5	mA
Grid-No.1 Voltage (Approx.) for plate current of 20 μA		—9	—8	volts



**MEDIUM-MU TRIODE—  
SHARP-CUTOFF PENTODE**

**6U9/  
ECF201**  
5U9/LCF201

Miniature type used in if-amplifier and sound and sync applications in television receivers. Outlines section, 6B, except has 10-pin base; requires miniature 10-contact socket. Type 5U9/LCF201 is identical with type 6U9/ECF201 except for heater ratings.

	5U9/LCF201	6U9/ECF201	
Heater Voltage	5.9	6.3	volts
Heater Current	0.45	0.41	ampere
Peak Heater-Cathode Voltage	±100 max	±150 max	volts
Direct Interelectrode Capacitance:			
Pentode Unit:			
Plate to All Other Elements (except grid No.1)		2.5	pF
Grid No.1 to All Other Elements (except plate)		6.5	pF
Grid No.1 to Cathode		4.0	pF
Plate to Grid No.1		<6.5	pF
Grid No.1 to Grid No.2		1.8	pF
Triode Unit:			
Plate to All Other Elements (except grid)		2.0	pF
Grid to All Other Elements (except plate)		2.5	pF
Plate to Grid		2.0	pF
Pentode Plate to Triode Plate		<15	pF
Pentode Grid No.1 to Triode Plate		<1.2	pF
Pentode Grid No.1 to Triode Grid		<1.5	pF

**Class A, Amplifier**

MAXIMUM RATINGS (Design-Maximum Values)		Triode Unit	Pentode Unit	
Plate Supply Voltage		550	550	volts
Plate Voltage		250	250	volts
Grid-No.2 (Screen-Grid) Supply Voltage		—	550	volts
Grid-No.2 Voltage		—	250	volts
Peak Cathode Current*		50	—	mA
Cathode Current		18	18	mA
Plate Dissipation		1.6	2.1	watts
Grid-No.2 Input		—	0.7	watt
CHARACTERISTICS				
Plate Voltage		100	160	volts
Grid-No.3 (Suppressor-Grid) Voltage		—	0	volts
Grid-No.2 Voltage		—	110	volts
Grid-No.1 (Control-Grid) Voltage		—2	—1.4	volts



Mu Factor, Grid No.1 to Grid No.2 .....	—	45	
Amplification Factor .....	17	—	
Transconductance .....	5000	12000	μmhos
Plate Current .....	14	13	mA
Grid-No.2 Current .....	—	5	mA

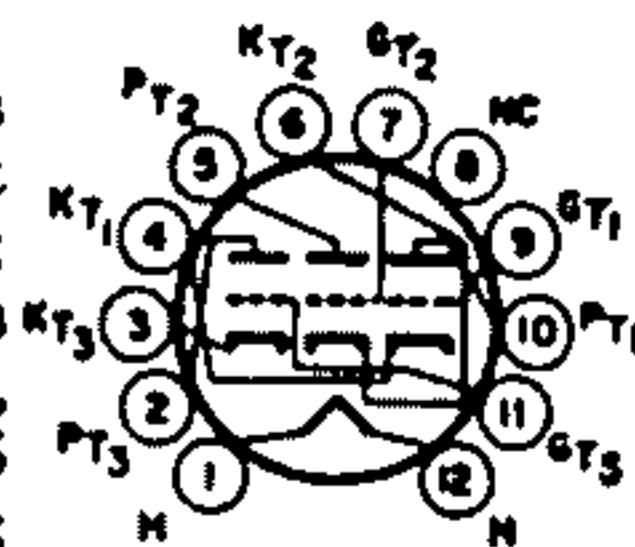
**MAXIMUM CIRCUIT VALUES**

Grid-No.1-Circuit Resistance .....	1	1	megohm
------------------------------------	---	---	--------

\* With a maximum duty cycle of 0.10 and maximum pulse duration of 10 microseconds.

## 6U10 THREE-UNIT TRIODE

Duodecar type used in amplifier applications. Units No.1 and No.3 are medium-mu triode units, and unit No.2 is a high-mu triode unit. Outlines section, 8A; requires duodecar 12-contact socket. Heater: volts (ac/dc), 6.3; amperes, 0.6; warm-up time (average), 11 seconds; maximum heater-cathode volts, ±275 (peak) for units 1 and 3; ±200 (peak) for unit 2; 100 (average) for each unit.



12FE

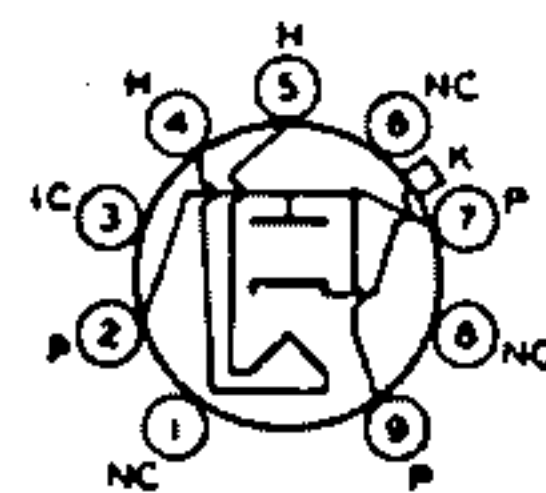
### Class A<sub>1</sub> Amplifier

	Units Nos. 1 and 3	Unit No.2	
<b>MAXIMUM RATINGS (Design-Maximum Values)</b>			
Plate Voltage .....	330	330	volts
DC Grid Voltage:			
Positive-bias value .....	0	0	volts
Negative-bias value .....	-50	-50	volts
Average Cathode Current .....	20	—	mA
Plate Dissipation .....	2	1	watts
<b>CHARACTERISTICS</b>			
Plate Voltage .....	200	200	volts
Grid Voltage .....	-6	-1.5	volts
Amplification Factor .....	17.5	90	
Plate Resistance (Approx.) .....	7700	61000	ohms
Transconductance .....	2300	1600	μmhos
Plate Current .....	9.6	1.2	mA
Grid Voltage (Approx.):			
For plate current of 100 μA .....	-15	—	volts
For plate current of 35 μA .....	—	-3	volts
<b>MAXIMUM CIRCUIT VALUES</b>			
Grid-Circuit Resistance:			
For fixed-bias operation .....	1	0.5	megohm
For cathode-bias operation .....	2.2	1*	megohms

\* This value may reach 10 megohms provided the plate-supply voltage and load resistance are such that the plate dissipation can never exceed 0.5 watt.

## 6V3A HALF-WAVE VACUUM RECTIFIER

Miniature type used as a damper tube in horizontal-deflection circuits of television receivers. Outlines section, 7B; requires miniature 9-contact socket. This tube, like other power-handling tubes, should be adequately ventilated. Heater: volts (ac/dc), 6.3; amperes, 1.75.



9BD

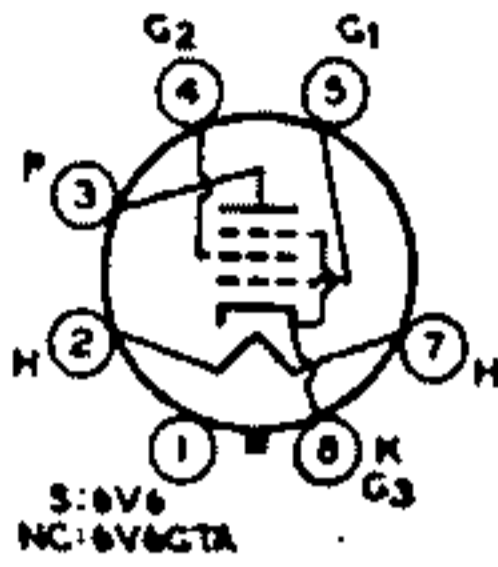
### Damper Service

For operation in a 525-line, 30-frame system

<b>MAXIMUM RATINGS (Design-Center Values)</b>			
Peak Inverse Plate Voltage# (Absolute Maximum) .....		6000†	volts
Peak Plate Current .....		800	mA
Average Plate Current .....		186	mA
Heater-Cathode Voltage:			
Peak value .....	+300	-6750†	volts
Average value .....	+100	-750†	volts

# Pulse duration must not exceed 15% of a horizontal scanning cycle (10 microseconds).

† Under no circumstances should this absolute value be exceeded.



**BEAM POWER TUBE**

**6V6  
6V6GTA**

5V6GT, 12V6GT

Metal type 6V6 and glass octal type 6V6GTA are used as output amplifiers in automobile, battery-operated, and other receivers in which reduced plate-current drain is desirable. Outlines section, 2B and 13D, respectively; require octal socket. These tubes are equivalent in performance to type 6AQ5A. Refer to type 6AQ5A for average plate characteristic curves. Types 5V6GT and 12V6GT are identical with type 6V6GTA except for heater ratings.

	5V6GT	6V6	6V6GTA	12V6GT	
Heater Voltage (ac/dc)	4.7	6.3	6.3	12.6	volts
Heater Current	0.6	0.45	0.45	0.225	ampere
Heater Warm-up Time (Average)	11	—	11	—	seconds
Heater-Cathode Voltage:					
Peak value	±200 max	±200 max	±200 max	±200 max	volts
Average value	100 max	100 max	100 max	100 max	volts
Direct Interelectrode Capacitances (Approx.):					
Grid No.1 to Plate			0.3	0.7	pF
Grid No.1 to Cathode, Heater, Grid No.2, and Grid No.3			10	9.0	pF
Plate to Cathode, Heater, Grid No.2, and Grid No.3			11	7.5	pF

\* With shell connected to cathode.

**Class A<sub>1</sub> Amplifier**

**MAXIMUM RATINGS (Design-Maximum Values)**

Plate Voltage	350	volts
Grid-No.2 (Screen-Grid) Voltage	315	volts
Plate Dissipation	14	watts
Grid-No.2 Input	2.2	watts

**TYPICAL OPERATION**

Plate Voltage	180	250	315	volts
Grid-No.2 Voltage	180	250	225	volts
Grid-No.1 (Control-Grid) Voltage	-8.5	-12.5	-13	volts
Peak AF Grid-No.1 Voltage	8.5	12.5	13	volts
Zero-Signal Plate Current	29	45	34	mA
Maximum-Signal Plate Current	30	47	35	mA
Zero-Signal Grid-No.2 Current	3	4.5	2.2	mA
Maximum-Signal Grid-No.2 Current	4	7	6	mA
Plate Resistance (Approx.)	50000	50000	80000	ohms
Transconductance	3700	4100	3750	μmhos
Load Resistance	5500	5000	8500	ohms
Total Harmonic Distortion	8	8	12	per cent
Maximum-Signal Power Output	2	4.5	5.5	watts

**CHARACTERISTICS (Triode Connection)<sup>a</sup>**

Plate Voltage	250	volts
Grid-No.1 (Control-Grid) Voltage	-12.5	volts
Amplification Factor	9.8	
Plate Resistance (Approx.)	1960	ohms
Transconductance	5000	μmhos
Plate Current	49.5	mA
Grid-No.1 Voltage (Approx.) for plate current of 0.5 mA	-38	volts

<sup>a</sup> Grid No.2 connected to plate.

**Push-Pull Class A<sub>1</sub> Amplifier**

**MAXIMUM RATINGS (Same as for class A<sub>1</sub> amplifier)**

**TYPICAL OPERATION (Values are for two tubes)**

Plate Voltage	250	285	volts
Grid-No.2 Voltage	250	285	volts
Grid-No.1 (Control-Grid) Voltage	-15	-19	volts
Peak AF Grid-No.1-to-Grid-No.1 Voltage	30	38	volts
Zero-Signal Plate Current	70	70	mA
Maximum-Signal Plate Current	79	92	mA
Zero-Signal Grid-No.2 Current	5	4	mA
Maximum-Signal Grid-No.2 Current	18	13.5	mA
Effective Load Resistance (Plate-to-Plate)	10000	8000	ohms

Total Harmonic Distortion .....	5	2.5	per cent
Maximum-Signal Power Output .....	10	14	watts
<b>MAXIMUM CIRCUIT VALUES</b>			
Grid-No.1-Circuit Resistance:			
For fixed-bias operation .....		0.1	megohm
For cathode-bias operation .....		0.5	megohm

**Vertical-Deflection Amplifier (Triode Connection)**

For operation in a 525-line, 30-frame system

<b>MAXIMUM RATINGS (Design-Maximum Values)</b>			
DC Plate Voltage .....		350	volts
Peak Positive-Pulse Plate Voltage# .....		1200	volts
Peak Negative-Pulse Grid-No.1 (Control-Grid) Voltage .....		275	volts
Peak Cathode Current .....		115	mA
Average Cathode Current .....		40	mA
Plate Dissipation .....		10	watts
<b>MAXIMUM CIRCUIT VALUE</b>			
Grid-No.1-Circuit Resistance, for cathode-bias operation .....		2.2	megohms

\* Grid No.2 connected to plate.

# Pulse duration must not exceed 15% of a vertical scanning cycle (2.5 milliseconds).

**6V6GT**

Refer to chart at end of section.

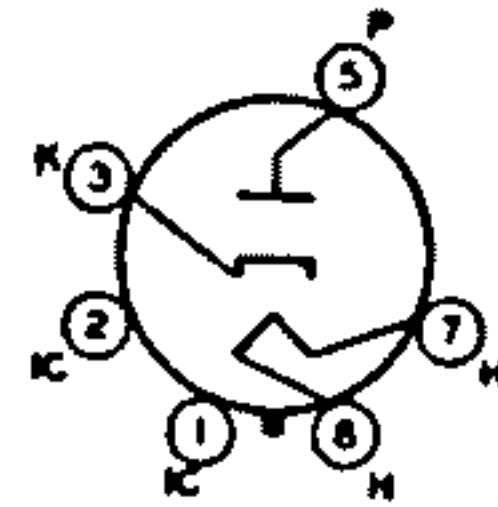
**6V7G**

Refer to chart at end of section.

**6W4GT**

**HALF-WAVE  
VACUUM RECTIFIER**

Glass octal type used as damper tube in television receivers. Outlines section, 13D; requires octal socket. This type may be supplied with pin No.1 omitted. Socket terminals 1, 2, 4, and 6 should not be used as tie points. This tube, like other power-handling tubes, should be adequately ventilated. Power-rectifier operation of this type is not recommended.



**4CG**

Heater Voltage (ac) .....	6.3	volts
Heater Current .....	1.2	amperes
Direct Interelectrode Capacitances (Approx.):		
Plate to Cathode and Heater .....	6	pF
Cathode to Plate and Heater .....	13	pF
Heater to Cathode .....	7	pF

**Damper Service**

For operation in a 525-line, 30-frame system

<b>MAXIMUM RATINGS (Design-Center Values)</b>			
Peak Inverse Plate Voltage (Absolute Maximum)# .....		8850	volts
Peak Plate Current .....		750	mA
Average Plate Current .....		125	mA
Plate Dissipation .....		3.5	watts
Heater-Cathode Voltage:			
Peak value .....	+300	-2300	volts
Average value .....	+100	-500	volts

**CHARACTERISTICS, Instantaneous Value**

Tube Voltage Drop for plate current of 250 mA .....		21	volts
---	--	----	-------

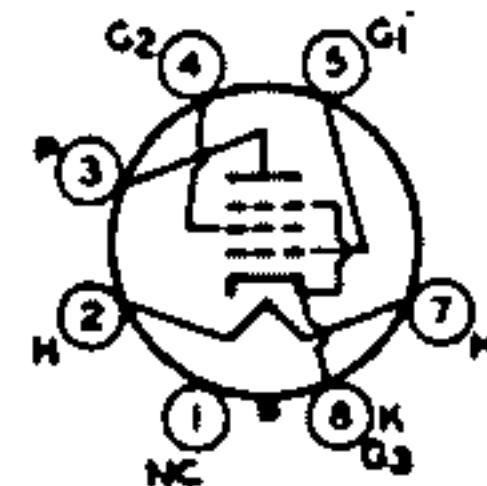
# Pulse duration must not exceed 15% of a horizontal scanning cycle (10 microseconds).

**6W6GT**

**12W6GT**

**BEAM POWER TUBE**

Glass octal type used in the audio output stage of radio and color and black-and-white television receivers. Triode-connected, it is used as a vertical-deflection amplifier in television receivers. Outlines section, 13D; requires octal socket. This type may be supplied with pin No.1 omitted. Type 12W6GT is identical with type 6W6GT except for heater ratings.



**7AC**



	6W6GT	12W6GT	
Heater Voltage (ac/dc)	6.3	12.6	volts
Heater Current	1.2	0.6	ampere
Heater Warm-up Time (Average)	—	11	seconds
Heater-Cathode Voltage:			
Peak value	±200 max	+200 max -300 max	volts
Average value	100 max	+100 max -200 max	volts
Direct Interelectrode Capacitances (Approx.):			
Grid No.1 to Plate		0.8	pF
Grid No.1 to Cathode, Heater, Grid No.2, and Grid No.3		15	pF
Plate to Cathode, Heater, Grid No.2, and Grid No.3		9	pF

**Class A<sub>1</sub> Amplifier**

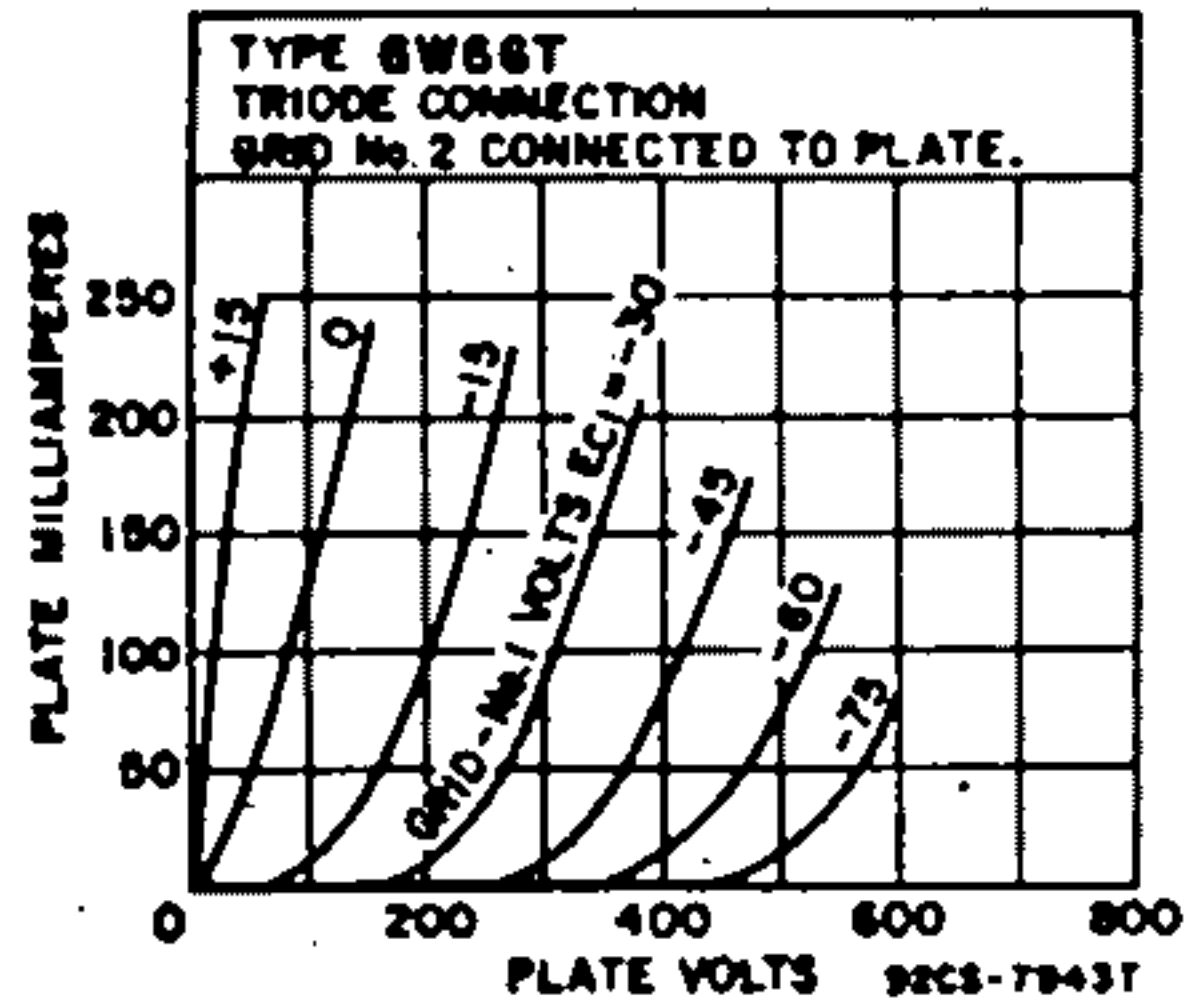
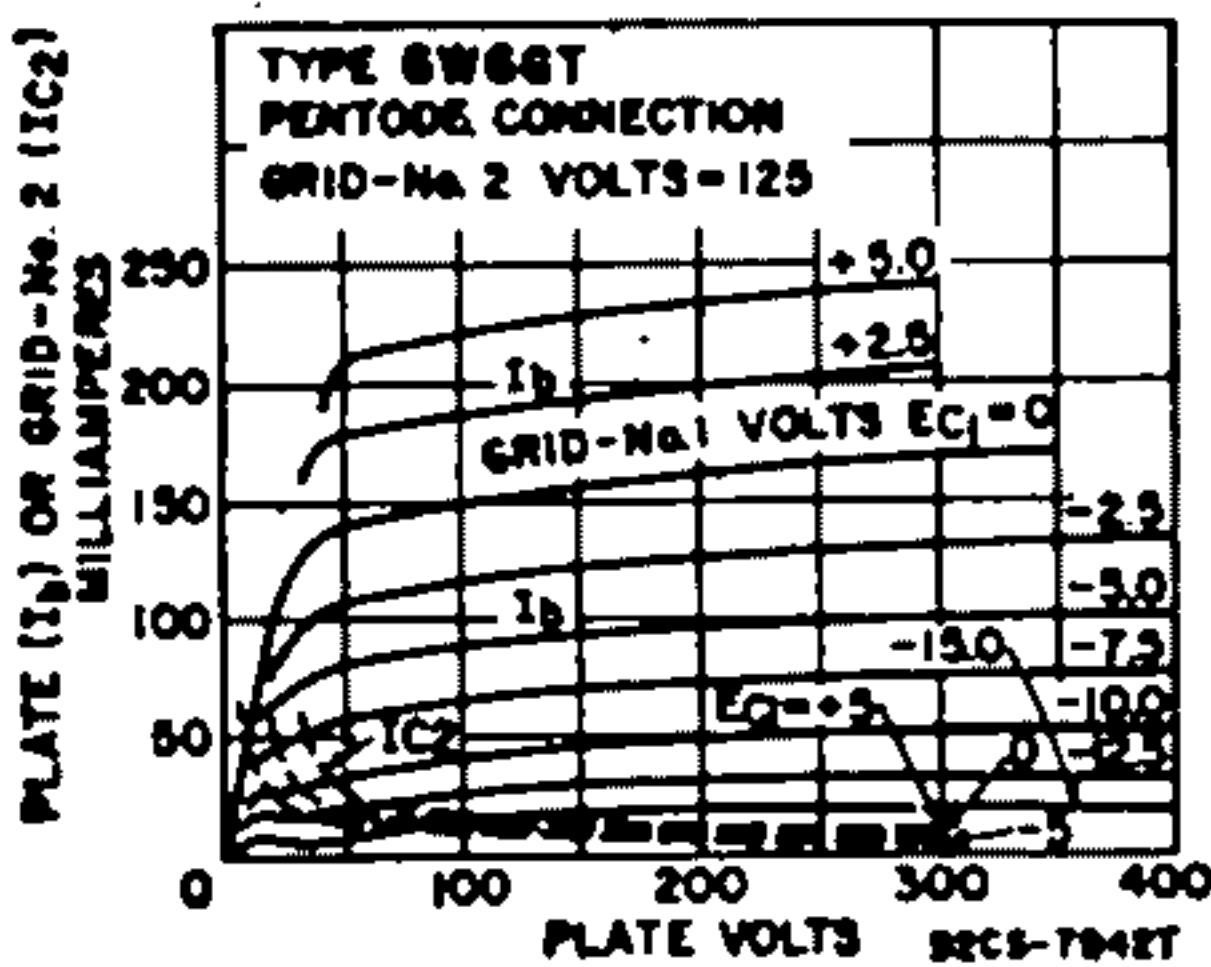
MAXIMUM RATINGS (Design-Maximum Values)			
Plate Voltage		350	volts
Grid-No.2 (Screen-Grid) Voltage		165	volts
Plate Dissipation		12	watts
Grid-No.2 Input		1.85	watts

TYPICAL OPERATION			
Plate Supply Voltage	110	200	volts
Grid-No.2 Supply Voltage	110	125	volts
Grid-No.1 (Control-Grid) Voltage	-7.5	—	volts
Cathode-Bias Resistor	—	180	ohms
Peak AF Grid-No.1 Voltage	7.5	8.5	volts
Zero-Signal Plate Current	49	46	mA
Maximum-Signal Plate Current	50	47	mA
Zero-Signal Grid-No.2 Current	4	2.2	mA
Maximum-Signal Grid-No.2 Current	10	8.5	mA
Plate Resistance (Approx.)	18000	28000	ohms
Transconductance	8000	8000	μmhos
Load Resistance	2000	4000	ohms
Total Harmonic Distortion (Approx.)	10	10	per cent
Maximum-Signal Power Output	2.1	3.8	watts

CHARACTERISTICS (Triode Connection)*			
Plate Voltage		225	volts
Grid-No.1 Voltage		-30	volts
Amplification Factor		6.2	
Plate Resistance (Approx.)		1600	ohms
Transconductance		8800	μmhos
Plate Current		22	mA
Grid No.1 Voltage (Approx.) for plate current of 0.5 mA		-42	volts

MAXIMUM CIRCUIT VALUES			
Grid-No.1 Circuit Resistance:			
For fixed-bias operation		0.1	megohm
For cathode-bias operation		0.5	megohm

\* Grid No.2 connected to plate.



**Vertical Deflection Amplifier**

For operation in a 525-Line, 30-frame system

MAXIMUM RATINGS (Design-Maximum Values)	Triode Connection*	Pentode Connection	
DC Plate Voltage	350	350	volts
Peak Positive-Pulse Plate Voltage†	1200	1600	volts

DC Grid No.2 (Screen-Grid) Voltage .....	—	165	volts
Peak Negative-Pulse Grid-No.1 Voltage .....	—275	—275	volts
Peak Cathode Current .....	195	195	mA
Average Cathode Current .....	65	65	mA
Plate Dissipation .....	8.5	8	watts
Grid-No.2 Input .....	—	1.2	watts

**MAXIMUM CIRCUIT VALUE**

Grid-No.1-Circuit Resistance, for cathode-bias operation	2.2	2.2	megohms
--	-----	-----	---------

\* Grid No.2 connected to plate.

# Pulse duration must not exceed 15% of a vertical scanning cycle (2.5 milliseconds).

**6W7G**

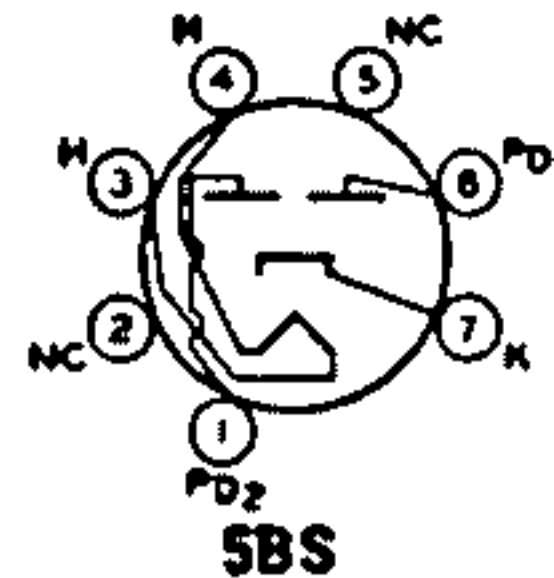
Refer to chart at end of section.

**6X4**

12X4

**FULL-WAVE  
VACUUM RECTIFIER**

Miniature type used in power supply of automobile and ac-operated radio receivers. Equivalent in performance to larger type 6X5GT. Outlines section, 5D; requires miniature 7-contact socket. This tube, like other power-handling tubes, should be adequately ventilated. For discussion of Rating Chart and Operation Characteristics, refer to Interpretation of Tube Data. Type 12X4 is identical with type 6X4 except for heater ratings.



**SBS**

Heater Voltage (ac/dc) .....	6X4	12X4	volts
Heater Current .....	6.3 <sup>A</sup>	12.6	ampere
Heater-Cathode Voltage:			
Peak value .....	+200, —450 max		volts
Average value .....	100 max		volts

<sup>A</sup> When the heater is operated from a 3-cell (nominal-6-volt) storage-battery source, the permissible heater-voltage range is from 5 to 8 volts.

**Full-Wave Rectifier**

**MAXIMUM RATINGS (Design-Maximum Values)**

Peak Inverse Plate Voltage .....	1250	volts
Steady-State Peak Plate Current (Per Plate) .....	245	mA
AC Plate Supply Voltage (Per Plate, rms) .....	See Rating Chart	
DC Output Voltage (At filter input)† .....	350	volts
Average Output Current (Each plate)† .....	45	mA
Hot-Switching Transient Plate Current .....	#	

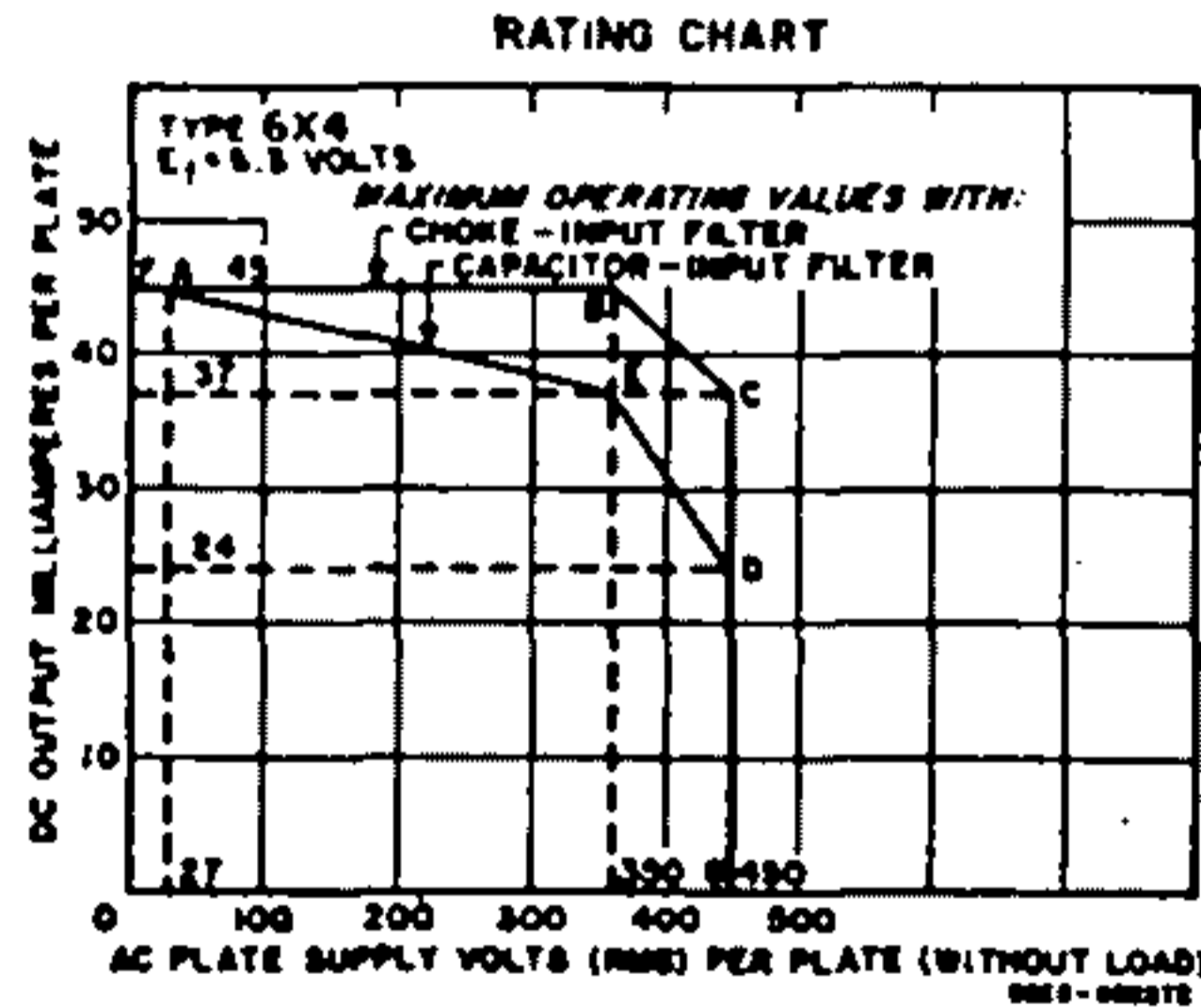
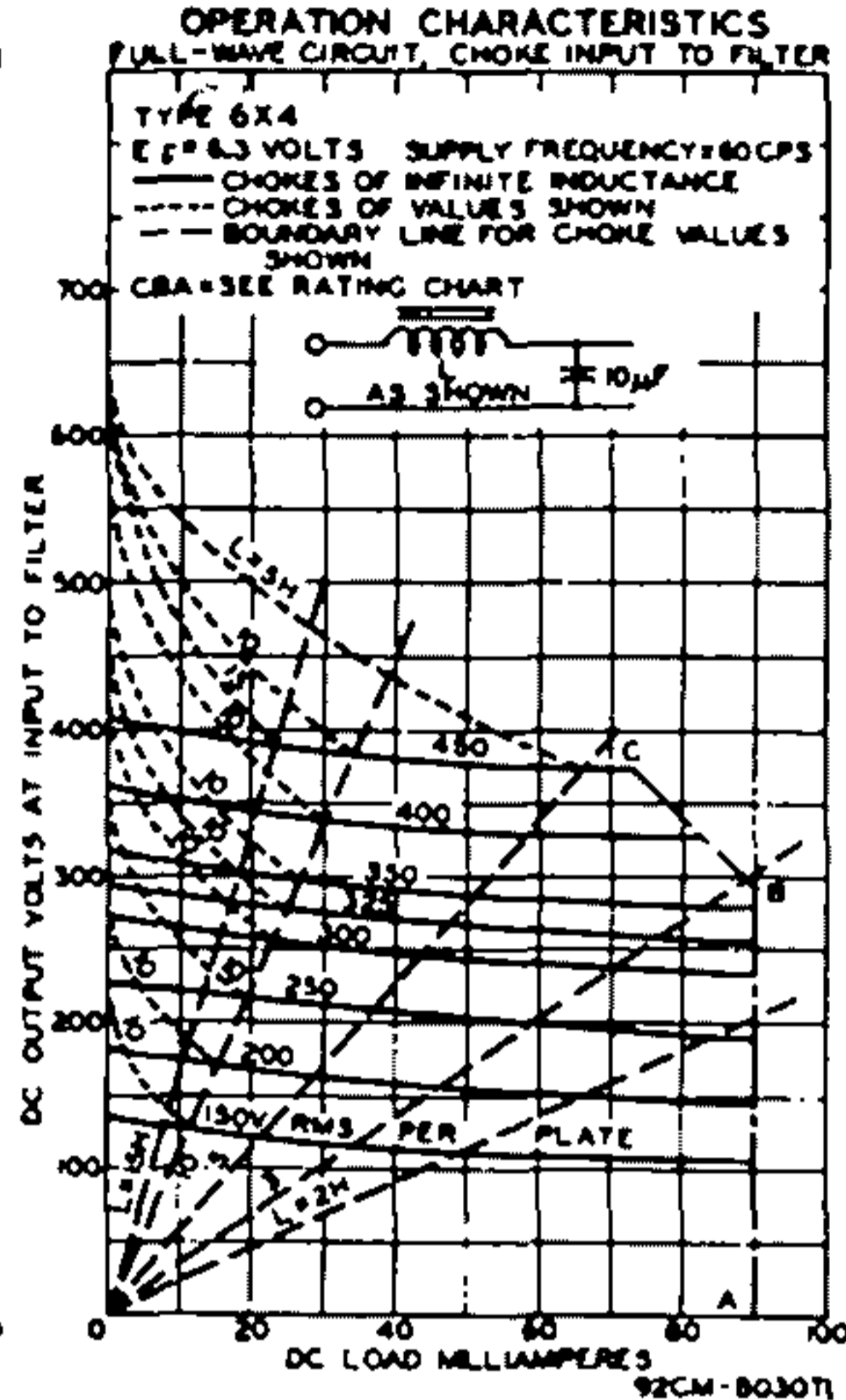
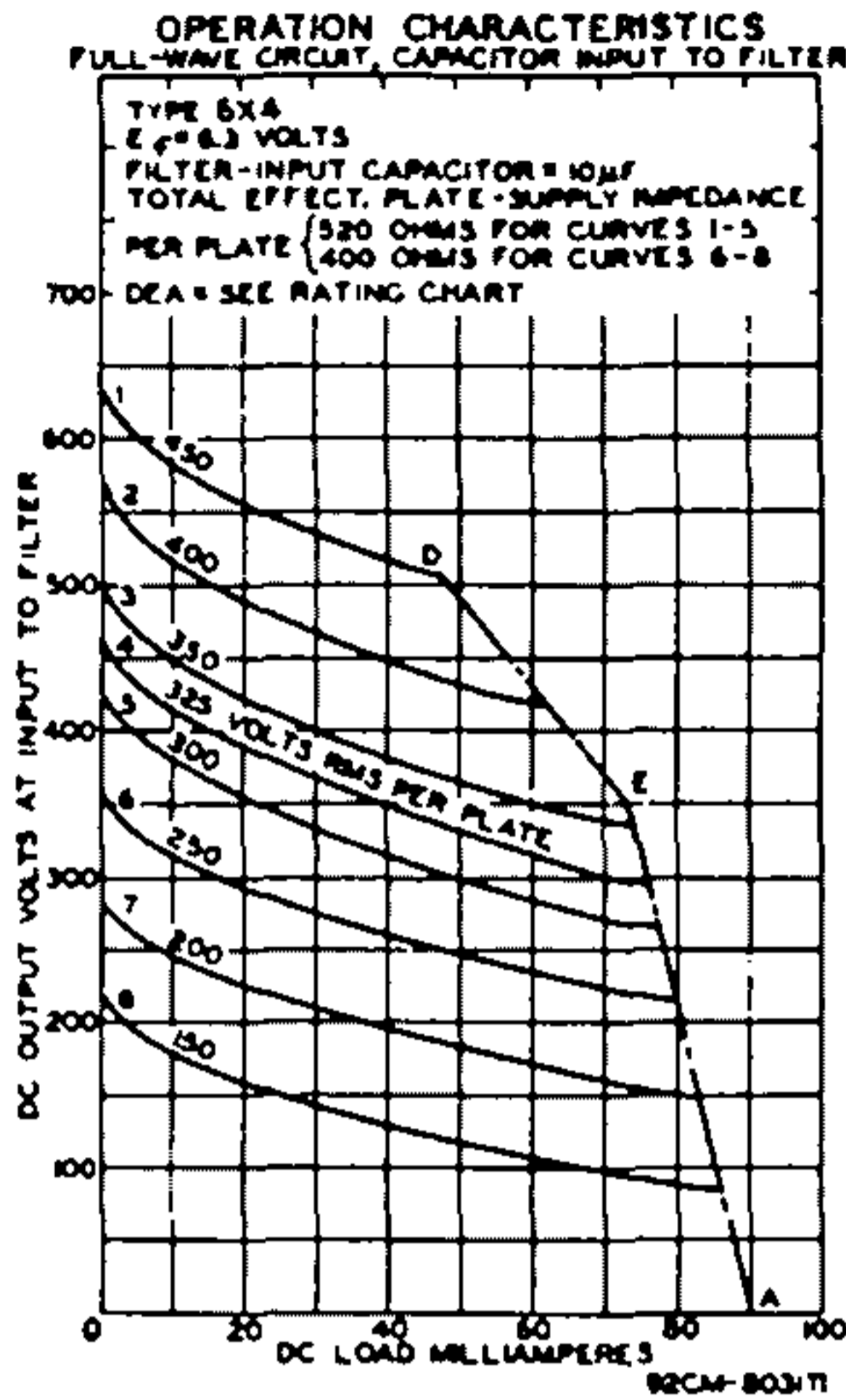
† This rating applies when the 6X4 is used in vibrator operation with a minimum duty cycle of 75 per cent.

# If hot-switching is regularly required in operation, the use of choke-input circuits is recommended. Such circuits limit the hot-switching current to a value no higher than that of the peak plate current. When capacitor-input circuits are used, a maximum peak current value per plate of 1.1 amperes during the initial cycles of the hot-switching transient should not be exceeded.

**TYPICAL OPERATION**

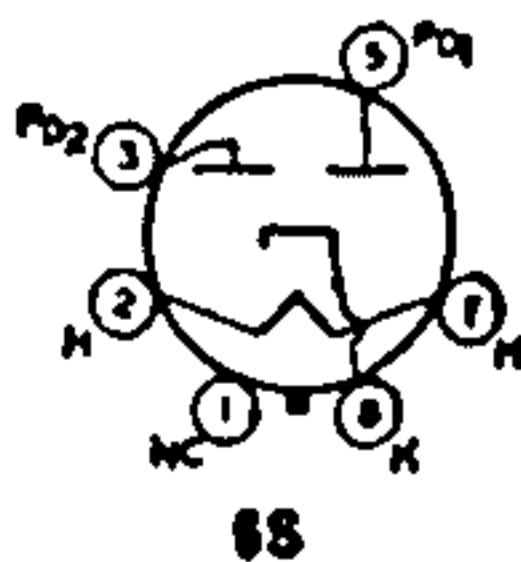
	Sine Wave Operation		Vibrator	
	Capacitor	Choke	Operation	
			Capacitor	
Filter Input				
AC Plate Supply Voltage (Each plate, rms)* ..	325	400	—	volts
Filter Input Capacitor .....	10	—	10	μF
Effective Plate Supply Impedance (Each plate) ..	525	—	—	ohms
Filter Input Choke .....	—	10	—	henries
Average Output Current .....	70	70	70	mA
DC Output Voltage at Input to Filter (Approx.)	310	340	340	volts

\* AC plate supply voltage is measured without load.



Refer to chart at end of section.

6X5



**FULL-WAVE  
VACUUM RECTIFIER**

**6X5GT**

Glass octal type used in power supply of automobile and ac-operated receivers. Outlines section, 13D; requires octal socket. This type may be supplied with pin No.1 omitted. For maximum ratings, and typical operation, refer to type 6X4.



# 6X8

5X8, 19X8

## MEDIUM-MU TRIODE— SHARP-CUTOFF PENTODE

Miniature type used as combined oscillator and mixer tube in television receivers utilizing an intermediate frequency in the order of 40 MHz and in AM/FM receivers. Outlines section, 6B; requires miniature 9-contact socket. Types 5X8 and 19X8 are identical with type 6X8 except for heater ratings.



9AK

	5X8	6X8	19X8	
Heater Voltage (ac/dc)	4.7	6.3	18.4	volts
Heater Current	0.6	0.46	0.15	ampere
Heater Warm-up Time (Average)	11	—	—	seconds
Heater-Cathode Voltage:				
Peak value	±200 max	±200 max	±200 max	volts
Average value	100 max	100 max	100 max	volts
Direct Interelectrode Capacitances:				
Triode Unit:				
Grid to Plate	1.5	1.5		pF
Grid to Cathode and Heater	2	2.4		pF
Plate to Cathode and Heater	0.5	1		pF
Pentode Unit:				
Grid No.1 to Plate	0.09 max	0.06 max		pF
Grid No.1 to Cathode, Heater, Grid No.2, and Grid No.3	4.6	4.8		pF
Plate to Cathode, Heater, Grid No.2, and Grid No.3	0.9	1.6		pF
Pentode Grid No.1 to Triode Plate	0.05 max	0.04 max		pF
Pentode Plate to Triode Plate	0.05 max	0.008 max		pF
Heater to Cathode	6.5	6.6*		pF

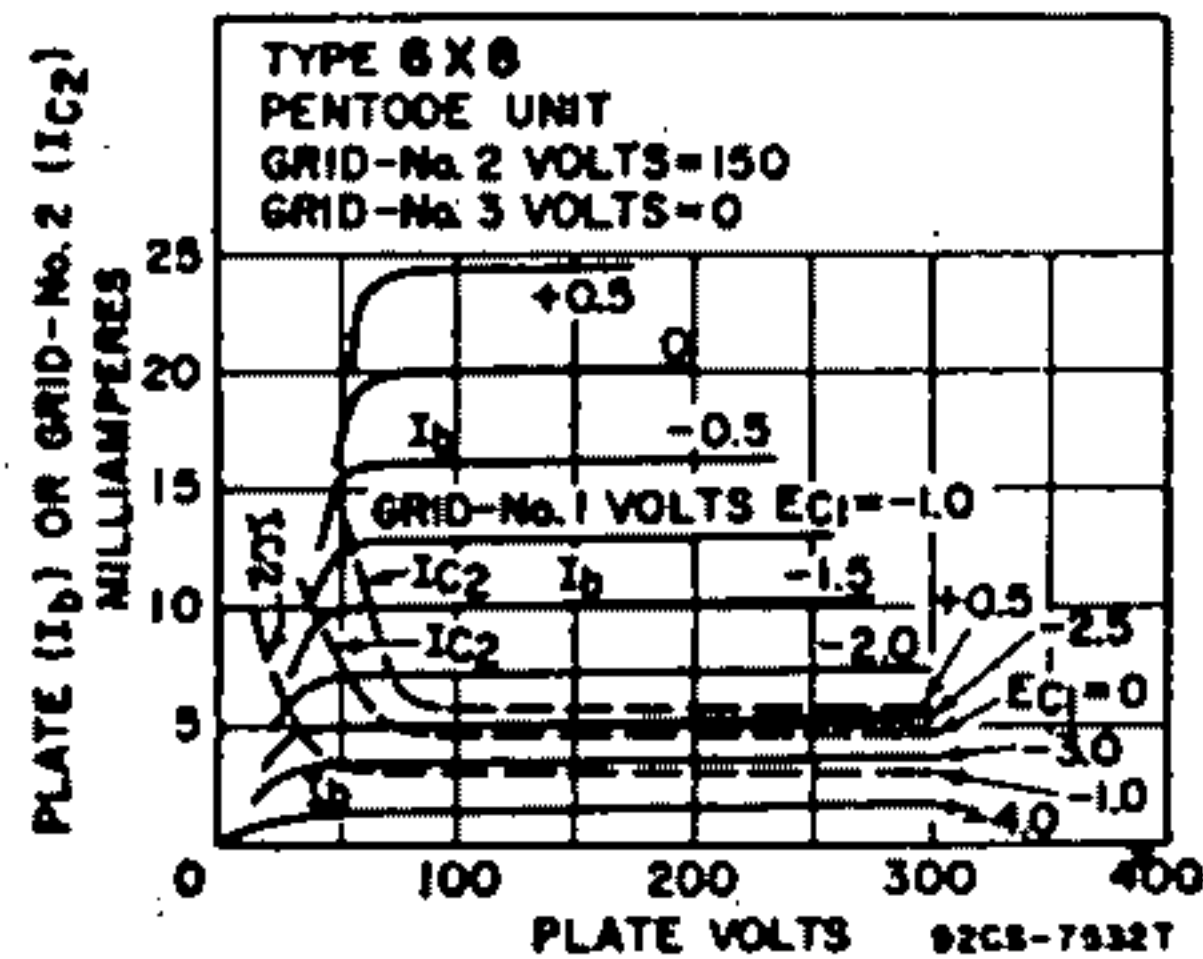
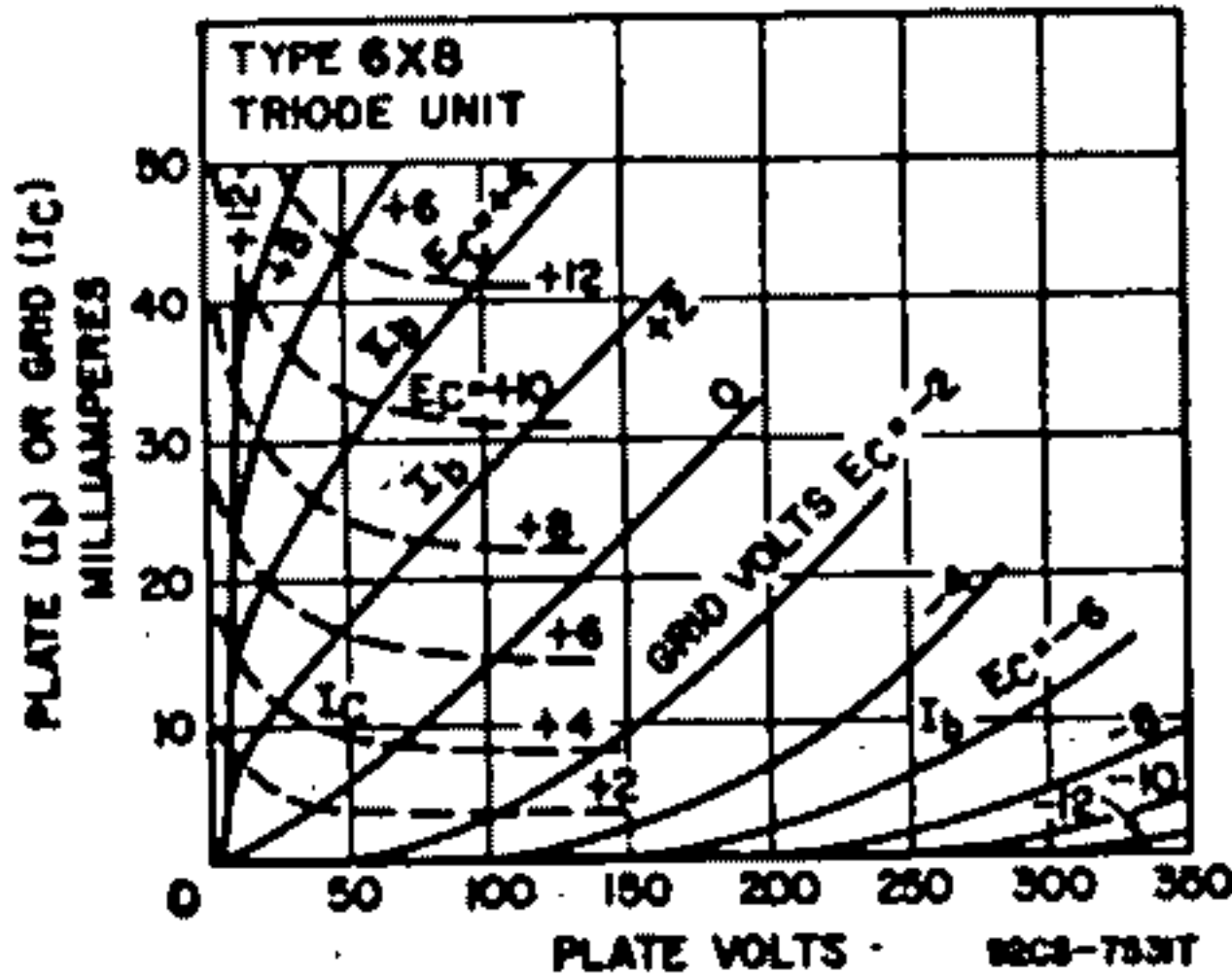
\* With external shield connected to cathode except as noted.  
 • With external shield connected to pentode plate.

### Class A<sub>1</sub> Amplifier

#### MAXIMUM RATINGS (Design-Maximum Values)

Plate Voltage	275	275	volts
Grid No.2 (Screen-Grid) Supply Voltage	—	275	volts
Grid-No.2 Voltage	—	See curve page 96	
Grid-No.1 (Control-Grid) Voltage, Positive-bias value	0	0	volts
Plate Dissipation	1.7	2.3	watts
Grid-No.2 Input:			
For grid-No.2 voltages up to 137.5 volts	—	0.45	watt
For grid-No.2 voltages between 137.5 and 275 volts	—	See curve page 96	

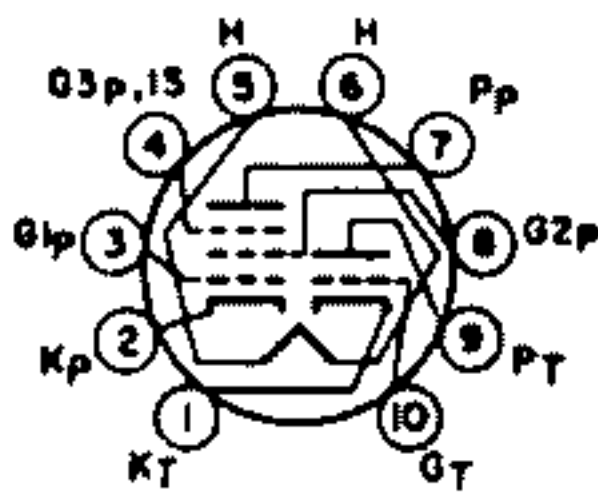
	Triode Unit	Pentode Unit	
Plate Voltage	275	275	volts
Grid No.2 (Screen-Grid) Supply Voltage	—	275	volts
Grid-No.2 Voltage	—	See curve page 96	
Grid-No.1 (Control-Grid) Voltage, Positive-bias value	0	0	volts
Plate Dissipation	1.7	2.3	watts
Grid-No.2 Input:			
For grid-No.2 voltages up to 137.5 volts	—	0.45	watt
For grid-No.2 voltages between 137.5 and 275 volts	—	See curve page 96	



#### CHARACTERISTICS

Plate Voltage	125	125	volts
Grid No.3	—	Connected to cathode at socket	
Grid-No.2 Voltage	—	125	volts
Grid-No.1 Voltage	-1	-1	volt
Amplification Factor	40	—	
Plate Resistance (Approx.)	6000	300000	ohms
Transconductance	6500	5500	amhos

Plate Current .....	12	9	mA
Grid-No.2 Current .....	—	2.2	mA
Grid-No.1 Voltage (Approx.) for plate current of 20 $\mu$ A .....	-7	-6.5	volts



10K

**HIGH-MU TRIODE—  
SHARP-CUTOFF PENTODE**

**6X9/  
ECF200**

Miniature type used as if-amplifier tube in television receivers. Outlines section 6B, except has 10-pin base; requires miniature 10-contact socket.

Heater Voltage .....	6.3	volts
Heater Current .....	0.41	ampere
Peak Heater-Cathode Voltage .....	$\pm 150$ max	volts
Direct Interelectrode Capacitances:		
Triode Unit:		
Plate to All Other Elements (except grid) .....	3.0	pF
Grid to All Other Elements (except plate) .....	2.5	pF
Plate to Grid .....	2.0	pF
Pentode Unit:		
Plate to All Other Elements (except grid No.1) .....	3.5	pF
Grid No.1 to All Other Elements (except plate) .....	6.5	pF
Grid No.1 to Cathode .....	4.0	pF
Plate to Grid No.1 .....	<6.5	fF
Grid No.1 to Grid No.2 .....	1.8	pF
Pentode Grid No.1 to Triode Plate .....	15	fF
Pentode Grid No.1 to Triode Grid .....	<1.2	fF
Pentode Plate to Triode Plate .....	<1.5	fF

**Class A<sub>1</sub> Amplifier**

**MAXIMUM RATINGS (Design-Maximum Values)**

	Triode Unit	Pentode Unit	
Plate Supply Voltage .....	550	550	volts
Plate Voltage .....	250	250	volts
Peak Plate Voltage* .....	600	—	volts
Grid-No.2 (Screen-Grid) Supply Voltage .....	—	550	volts
Grid-No.2 Voltage .....	—	250	volts
Cathode Current .....	18	18	mA
Plate Dissipation .....	1.5	2.1	watts
Grid-No.2 Input .....	—	0.7	watt

**CHARACTERISTICS**

Plate Voltage .....	170	160	volts
Grid-No.3 (Suppressor-Grid) Voltage .....	—	0	volts
Grid-No.2 Voltage .....	—	135	volts
Grid-No.1 (Control-Grid) Voltage .....	-1.0	-1.7	volts
Mu Factor, Grid-No.1 to Grid-No.2 .....	—	55	
Amplification Factor .....	65	—	
Transconductance .....	4800	14000	$\mu$ mhos
Plate Current .....	8.5	13	mA
Grid-No.2 Current .....	—	5	mA

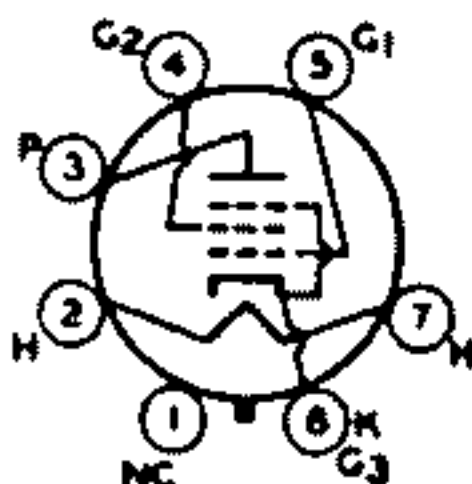
**MAXIMUM CIRCUIT VALUES**

Grid-No.1-Circuit Resistance .....	1	1	megohm
------------------------------------	---	---	--------

\* With a maximum duty factor of 0.18 and maximum pulse duration of 18 microseconds.

Refer to chart at end of section.

6Y5



7AC

**BEAM POWER TUBE**

**6Y6GA/  
6Y6G**

Glass octal type used as output amplifier in radio receivers and in rf-operated, high-voltage power supplies in television equipment. Outlines section, 19B; requires octal socket.

Heater Voltage (ac/dc) .....	6.3	volts
Heater Current .....	1.25	amperes
Peak Heater-Cathode Voltage .....	$\pm 180$ max	volts

Direct Interelectrode Capacitances (Approx.):

Grid No.1 to Plate .....	0.7	pF
Grid No.1 to Cathode, Heater, Grid No.2, and Grid No.3 .....	12	pF
Plate to Cathode, Heater, Grid No.2, and Grid No.3 .....	7.5	pF

**Class A<sub>1</sub> Amplifier**

**MAXIMUM RATINGS (Design-Center Values)**

Plate Voltage .....	200	volts
Grid-No.2 (Screen-Grid) Supply Voltage .....	200	volts
Grid-No.2 Voltage .....	See curve page 96	
Plate Dissipation .....	12.5	watts
Grid-No.2 Input:		
For grid-No.2 voltages up to 100 volts .....	1.75	watts
For grid-No.2 voltages between 100 and 200 volts .....	See curve page 96	

**TYPICAL OPERATION**

Plate Voltage .....	135	200	volts
Grid-No.2 Voltage .....	135	135	volts
Grid-No.1 (Control-Grid) Voltage .....	-13.5	-14	volts
Peak AF Grid-No.1 Voltage .....	13.5	14	volts
Zero-Signal Plate Current .....	68	61	mA
Maximum-Signal Plate Current .....	60	66	mA
Zero-Signal Grid-No.2 Current .....	3.5	2.2	mA
Maximum-Signal Grid-No.2 Current .....	11.5	9	mA
Plate Resistance (Approx.) .....	9300	18300	ohms
Transconductance .....	7000	7100	μmhos
Load Resistance .....	2000	2600	ohms
Total Harmonic Distortion .....	10	10	per cent
Maximum-Signal Power Output .....	3.6	6	watts

**MAXIMUM CIRCUIT VALUES**

Grid-No.1-Circuit Resistance:

For fixed-bias operation .....	0.1	megohm
For cathode-bias operation .....	0.6	megohm

**6Y7G**

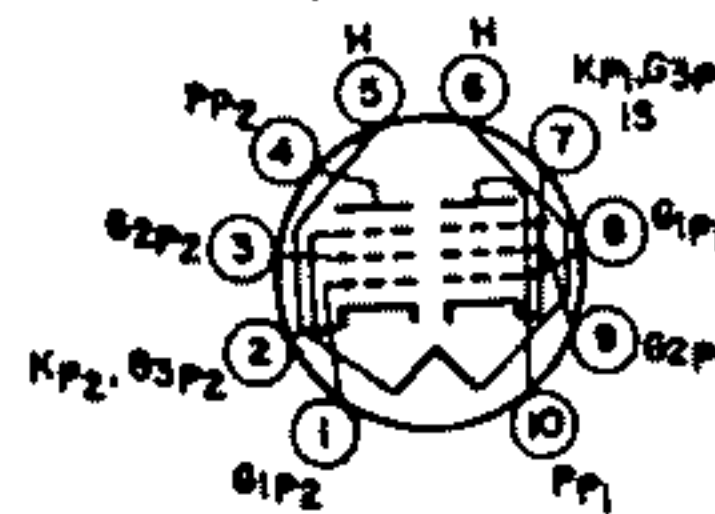
Refer to chart at end of section.

**6Y9**

11Y9

**DUAL PENTODE**

Miniature type for use in color and black-and-white television receiver applications. Unit No. 1 is used as a video output pentode, and unit No. 2 as a sound if amplifier, agc amplifier, or sync separator. Outlines section, 6L, except has 10-pin base; requires miniature 10-contact socket. Type 11Y9 is identical with type 6Y9 except for heater ratings.



10L

Heater Voltage .....	6Y9	11Y9	
Heater Current .....	0.8	0.45	volts
Peak Heater-Cathode Voltage .....	±200 max	±200 max	ampere
Direct Interelectrode Capacitances:			volts
Unit No.1:			
Plate to All Other Elements (except grid No.1) .....		7	pF
Grid No.1 to All Other Elements (except plate) .....		12	pF
Plate to Grid No.1 .....		95	fF
Unit No.2:			
Plate to All Other Elements (except grid No.1) .....		11	pF
Grid No.1 to All Other Elements (except plate) .....		10	pF
Plate to Grid No.1 .....		140	fF
Grid No.1 to Heater .....		<100	fF
Plate to Plate .....		<150	fF
Grid to Grid .....		<10	fF
Plate (Unit No.1) to Grid No.1 (Unit No.2) .....		<100	fF
Plate (Unit No.2) to Grid No.1 (Unit No.2) .....		<5	fF

**Class A<sub>1</sub> Amplifier**

**MAXIMUM RATINGS (Design-Maximum Values)**

	Unit No.1	Unit No.2	
Plate Supply Voltage .....	550	550	volts
Plate Voltage .....	250	250	volts
Grid-No.2 (Screen-Grid) Supply Voltage .....	550	550	volts
Grid-No.2 Voltage .....	250	250	volts
Cathode Current .....	60	15	mA
Plate Dissipation .....	5.0	1.5	watts
Grid-No.2 Input .....	2.5	0.5	watts



**CHARACTERISTICS**

Plate Voltage .....	170	150	volts
Grid-No.2 Voltage .....	170	150	volts
Grid-No.1 (Control-Grid) Voltage .....	-2.6	-2.3	volts
Mu Factor, Grid-No.1 to Grid-No.2 .....	88	85	
Internal Resistance .....	40	160	kohms
Transconductance .....	21000	8500	μmhos
Plate Current .....	80	10	mA
Grid-No.2 Current .....	6.5	3.0	mA

**MAXIMUM CIRCUIT VALUES**

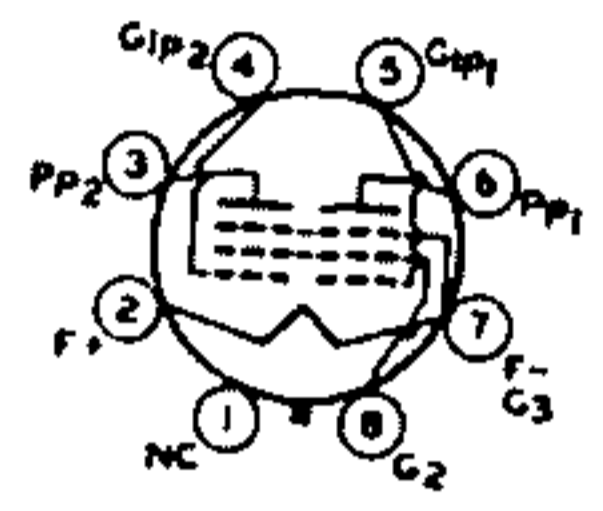
Grid-No.1-Circuit Resistance .....	1	1	megohm
------------------------------------	---	---	--------

Refer to chart at end of section.

**6Z5**

Refer to chart at end of section.

**6Z7G**



**12BT**

**PENTODE—  
BEAM POWER TUBE**

**6Z10**

Duodecar type used as a combined limiter, discriminator, and audio power-output tube in FM radio and television receivers. Outlines section, 8C; requires duodecar 12-contact socket.

Heater Voltage (ac/dc) .....	6.3	volts
Heater Current .....	0.95	ampere
Heater-Cathode Voltage:		
Peak value .....	±200 max	volts
Average value .....	100 max	volts
Direct Interelectrode Capacitances:		
Pentode Unit:		
Grid No.1 to Grid No.3 .....	0.009	pF
Grid No.1 to Cathode, Heater, Grid No.2, Grid No.3, Plate, and Internal Shield .....	4.4	pF
Grid No.3 to Cathode, Heater, Grid No.1, Grid No.2, Plate, and Internal Shield .....	3.2	pF
Beam Power Unit:		
Grid No.1 to Plate .....	0.22	pF
Grid No.1 to Cathode, Heater, Grid No.2, and Grid No.3 .....	11	pF
Plate to Cathode, Heater, Grid No.2, and Grid No.3 .....	7.5	pF

**Pentode Unit As Class A<sub>1</sub> Amplifier**

**CHARACTERISTICS**

Plate Voltage .....	185	185	135	volts
Grid-No.3 (Suppressor-Grid) Voltage .....	4	4	4	volts
Grid-No.2 (Screen-Grid) Supply Voltage .....	—	280	280	volts
Grid-No.2 Voltage .....	75	—	—	volts
Grid No. 1 (Control-Grid) Voltage .....	0	0	0	volts
Grid-No.2 Resistor .....	—	33	33	kohms
Plate Resistance .....	—	—	—	megohms
Transconductance, Grid No.1 to Plate .....	—	—	360	μmhos
Transconductance, Grid No.3 to Plate .....	—	—	700	μmhos
Average Plate Current .....	—	5	—	mA
Grid-No.2 Current .....	4.5	—	—	mA
Grid-No.1 Voltage (Approx.) for plate current of 20 μA .....	—	—	-4	volts
Grid No.3 Voltage (Approx.) for plate current of 20 μA .....	—	—	-4	volts

**Beam Power Unit as Class A<sub>1</sub> Amplifier**

**MAXIMUM RATINGS (Design-Maximum Values)**

Plate Voltage .....	275	volts
Grid-No.2 (Screen-Grid) Voltage .....	275	volts
Plate Dissipation .....	10	watts
Grid-No.2 Input .....	2	watts

**TYPICAL OPERATION**

Plate Voltage .....	250	volts
Grid-No.2 Voltage .....	250	volts
Grid-No.1 (Control-Grid) Voltage .....	-8	volts
Peak AF Grid-No.1 Voltage .....	8	volts
Zero-Signal Plate Current .....	85	mA
Maximum-Signal Plate Current .....	89	mA
Zero-Signal Grid-No.2 Current .....	3	mA
Maximum-Signal Grid-No.2 Current .....	13	mA
Plate Resistance (Approx.) .....	0.1	megohm
Transconductance .....	6500	μmhos

Load Resistance .....	5000	ohms
Total Harmonic Distortion .....	8.5	per cent
Maximum-Signal Power Output .....	4.2	watts

**MAXIMUM CIRCUIT VALUES**

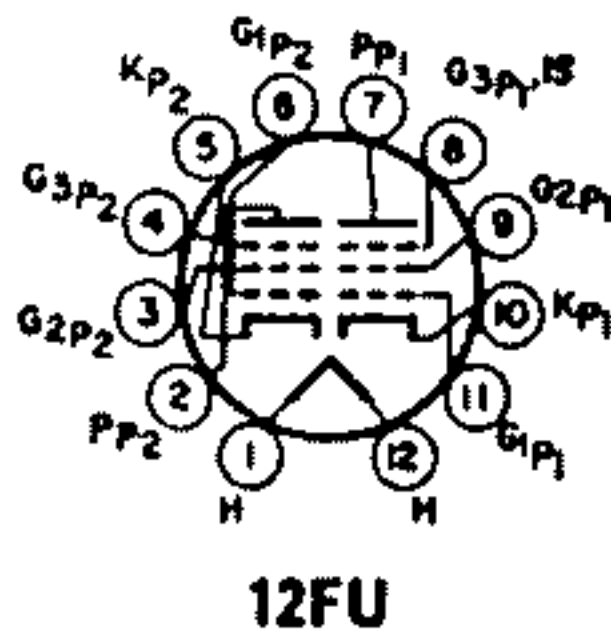
Grid-No.1-Circuit Resistance:		
For fixed-bias operation .....	0.25	megohm
For cathode-bias operation .....	0.5	megohm

**Pentode Unit as Limiter and Discriminator****MAXIMUM RATINGS (Design-Maximum Values)**

Plate Supply Voltage .....	330	volts
Grid-No.2 Voltage .....	330	volts
Grid-No.1 Voltage, Peak positive value .....	60	volts
Average Cathode Current .....	13	mA

<b>6ZY5G</b>	Refer to chart at end of section.
<b>7A4</b>	Refer to chart at end of section.
<b>7A5</b>	Refer to chart at end of section.
<b>7A6</b>	Refer to chart at end of section.
<b>7A7</b>	Refer to chart at end of section.
<b>7A8</b>	Refer to chart at end of section.
<b>7AD7</b>	Refer to chart at end of section.
<b>7AF7</b>	Refer to chart at end of section.
<b>7AG7</b>	Refer to chart at end of section.
<b>7AH7</b>	Refer to chart at end of section.
<b>7AU7</b>	Refer to type 12AU7A.
<b>7B4</b>	Refer to chart at end of section.
<b>7B5</b>	Refer to chart at end of section.
<b>7B6</b>	Refer to chart at end of section.
<b>7B7</b>	Refer to chart at end of section.
<b>7B8</b>	Refer to chart at end of section.
<b>7C5</b>	Refer to chart at end of section.
<b>7C6</b>	Refer to chart at end of section.
<b>7C7</b>	Refer to chart at end of section.
<b>7E6</b>	Refer to chart at end of section.
<b>7E7</b>	Refer to chart at end of section.
<b>7EY6</b>	Refer to chart at end of section.
<b>7F7</b>	Refer to chart at end of section.
<b>7F8</b>	Refer to chart at end of section.
<b>7G7</b>	Refer to chart at end of section.
<b>7H7</b>	Refer to chart at end of section.
<b>7HG8</b>	
<b>7HG8/PCF86</b>	Refer to type 6HG8.

Refer to chart at end of section.	<b>7J7</b>
Refer to chart at end of section.	<b>7K7</b>
Refer to chart at end of section.	<b>7L7</b>
Refer to chart at end of section.	<b>7N7</b>
Refer to chart at end of section.	<b>7Q7</b>
Refer to chart at end of section.	<b>7R7</b>
Refer to chart at end of section.	<b>7S7</b>
Refer to chart at end of section.	<b>7V7</b>
Refer to chart at end of section.	<b>7W7</b>
Refer to chart at end of section.	<b>7X7</b>
Refer to chart at end of section.	<b>7Y4</b>
Refer to chart at end of section.	<b>7Z4</b>
Refer to type 6AR11.	<b>8AR11</b>
Refer to type 6AU8A.	<b>8AU8</b>
Refer to type 6AW8A.	<b>8AW8A</b>
Refer to type 6B10.	<b>8B10</b>
Refer to type 6BA8A.	<b>8BA8A</b>
Refer to type 6BA11.	<b>8BA11</b>
Refer to type 6BH8.	<b>8BH8</b>



**DUAL PENTODE**

**8BM11**

Duodecar type used as if amplifier in television receivers. Unit No.1 is a semiremote-cutoff pentode, and unit No. 2 is a sharp-cutoff pentode. Outlines section, 8B; requires duodecar 12-contact socket. Heater: volts (ac/dc), 8.4; amperes, 0.45; maximum heater-cathode volts,  $\pm 200$  peak, 100 average.

**Class A<sub>1</sub> Amplifier**

**MAXIMUM RATINGS (Design-Maximum Values)**

	Unit No.1	Unit No.2	
Plate Voltage .....	160	160	volts
Grid-No.3 (Suppressor-Grid) Voltage .....	0	0	volts
Grid-No.2 (Screen-Grid) Voltage .....	160	160	volts
Grid-No.1 (Control-Grid) Voltage, Positive-bias value .....	0	0	volts
Plate Dissipation .....	2.2	2.2	watts
Grid-No.2 Input .....	0.55	0.55	watt

**CHARACTERISTICS**

Plate Supply Voltage .....	125	125	volts
Grid No.3 .....	Connected to cathode at socket		
Grid-No.2 Voltage .....	125	125	volts
Cathode-Bias Resistor .....	56	120	ohms
Plate Resistance (Approx.) .....	220000	300000	ohms
Transconductance .....	8800	8500	$\mu$ mhos
Plate Current .....	14	9.0	mA
Grid-No.2 Current .....	3.6	2.5	mA
Grid-No.1 Voltage (Approx.) for plate current of 20 $\mu$ A .....	—	-5.5	volts
Grid-No.1 Voltage (Approx.) for transconductance of 50 $\mu$ mho .....	-16.5	—	volts

**MAXIMUM CIRCUIT VALUES**

Grid-No.1-Circuit Resistance, for cathode-bias operation .....	1.0	0.25	megohm
--	-----	------	--------



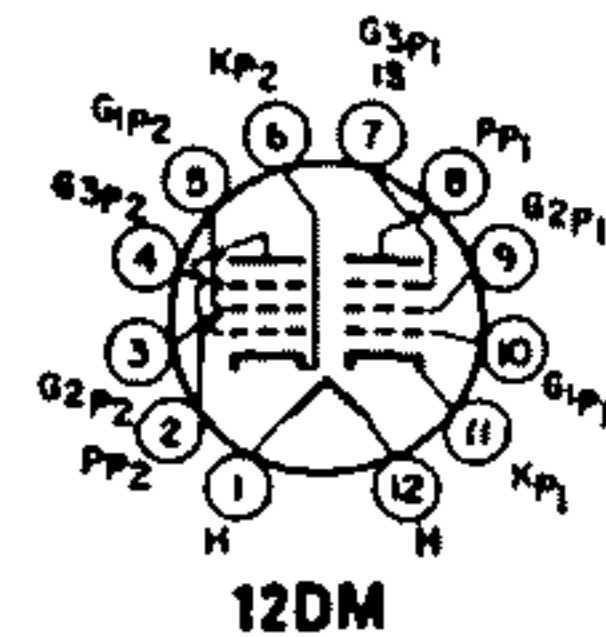
**8BN8**  
**8BQ5**

Refer to type 6BN8.  
Refer to type 6BQ5.

**8BQ11 SEMIREMOTE-CUTOFF DUAL PENTODE**

11BQ11

Duodecar type used as intermediate-frequency amplifier in television receivers. Outlines section, 8B; requires duodecar 12-contact socket. Type 11BQ11 is identical with type 8BQ11 except for heater ratings.



	8BQ11	11BQ11	
Heater Voltage (ac/dc)	8.4	11.2	volts
Heater Current	0.8	0.45	ampere
Heater Warm-up Time (Average)	11	11	seconds
Heater-Cathode Voltage:			
Peak value	±200 max	±200 max	volts
Average value	100 max	100 max	volts
Direct Interelectrode Capacitances:			
Grid No.1 to Plate	0.022	0.024	pF
Grid No.1 to Cathode, Heater, Grid No.2, Grid No.3, and Internal Shield	10	—	pF
Plate to Cathode, Heater, Grid No.2, Grid No.3, and Internal Shield	2.8	—	pF
Grid No.1 to Cathode, Heater, Grid No.2, Grid No.3, Grid No.3 of Unit No.1, and Internal Shield	—	71	pF
Plate to Cathode, Heater, Grid No.2, Grid No.3, Grid No.3 of Unit No.1, and Internal Shield	—	2.8	pF
Plate of Unit No.1 to Plate of Unit No.2	0.016	—	pF
Grid No.1 of Unit No.1 to Plate of Unit No.2	0.002	—	pF
Grid No.1 of Unit No.2 to Plate of Unit No.1	0.008	—	pF
Grid No.1 of Unit No.1 to Grid No.1 of Unit No.2	0.002	—	pF

**Class A<sub>1</sub> Amplifier**

	Unit No.1	Unit No.2	
<b>MAXIMUM RATINGS (Design-Maximum Values)</b>			
Plate Voltage	330	330	volts
Grid-No.3 (Suppressor-Grid) Voltage	0	0	volts
Grid-No.2 (Screen-Grid) Supply Voltage	330	330	volts
Grid-No.1 (Control-Grid) Voltage, Positive-bias value	See curve page 96	See curve page 96	
Plate Dissipation	0	0	volts
Grid-No.2 Input:	3.1	3.1	watts
For grid-No.2 voltages up to 165 volts	0.65	0.65	watt
For grid-No.2 voltages between 165 and 330 volts	See curve page 96	See curve page 96	

**CHARACTERISTICS**

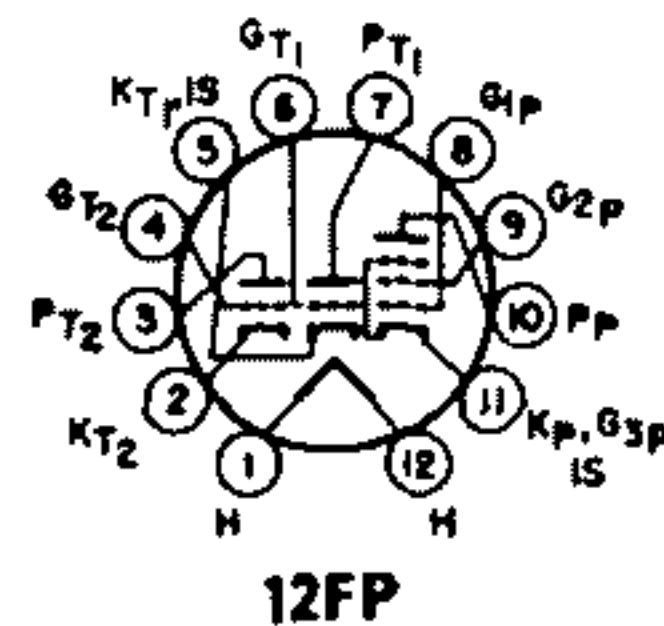
Plate Supply Voltage	125	125	volts
Grid No.3	Connected to cathode at socket		
Grid-No.2 Voltage	125	125	volts
Cathode-Bias Resistor	56	56	ohms
Plate Resistance (Approx.)	0.2	0.2	megohm
Transconductance	10500	13000	μmhos
Plate Current	11	11	mA
Grid-No.2 Current	3.5	3.8	mA
Grid-No.1 Voltage (Approx.) for plate current of 20 μA	—	—8	volts
Grid-No.1 Voltage (Approx.) for transconductance of 50 μmho	—15	—	volts

**MAXIMUM CIRCUIT VALUES**

Grid-No.1-Circuit Resistance, for cathode-bias operation	1.0	0.25	megohm
--	-----	------	--------

**8BU11 MEDIUM-MU TWIN TRIODE—SHARP-CUTOFF PENTODE**

Duodecar type used in television receiver applications. Outlines section, 8C; requires duodecar 12-contact socket. Heater: volts (ac/dc), 7.8; amperes, 0.6; warm-up time, 11 seconds, maximum heater-cathode volts, ±200 peak, 100 average.



**Class A<sub>1</sub> Amplifier**

**MAXIMUM RATINGS (Design-Maximum Values)**

	Pentode Unit	Each Triode Unit	
Plate Voltage .....	330	330	volts
Grid-No.2 (Screen-Grid) Supply Voltage .....	330	—	volts
Grid-No.2 Voltage .....	See curve page 96	—	
Grid-No.1 (Control-Grid) Voltage, Positive-bias value .....	0	0	volts
Plate Dissipation .....	2.5	1.8	watts
Grid-No.2 Input:			
For grid-No.2 voltages up to 165 volts .....	0.55	—	watt
For grid-No.2 voltages between 165 and 330 volts .....	See curve page 96	—	

**CHARACTERISTICS**

Plate Supply Voltage .....	125	125	volts
Grid-No.2 Voltage .....	125	—	volts
Grid-No.1 Voltage .....	-1.0	—	volts
Cathode-Bias Resistor .....	—	68	ohms
Amplification Factor .....	—	43	
Plate Resistance (Approx.) .....	200000	50000	ohms
Transconductance .....	7500	8600	μmhos
Plate Current .....	12	13.5	mA
Grid-No.2 Current .....	4.0	—	mA
Grid Voltage (Approx.) for plate current of 100 μA .....	—	-8	volts
Grid-No.1 Voltage (Approx.) for plate current of 30 μA .....	-8	—	volts

**MAXIMUM CIRCUIT VALUES**

Grid-No.1-Circuit Resistance:			
For fixed-bias operation .....	0.5	0.5	megohm
For cathode-bias operation .....	1.0	1.0	megohm

Refer to type 6FQ7/6CG7.

**8CG7**

Refer to type 6CM7.

**8CM7**

Refer to type 6CN7.

**8CN7**

Refer to type 6CS7.

**8CS7**

Refer to type 6CW5.

**8CW5**

Refer to type 6CX8.

**8CX8**

Refer to type 6EB8.

**8EB8**

Refer to type 6EM5.

**8EM5**

Refer to type 6ET7.

**8ET7**

Refer to chart at end of section.

**8FQ7**

Refer to type 6FQ7/6CG7.

**8FQ7/8CG7**

Refer to type 6GJ7.

**8GJ7**

Refer to type 6GN8.

**8GN8**

Refer to type 6JV8.

**8JV8**

Refer to type 6KA8.

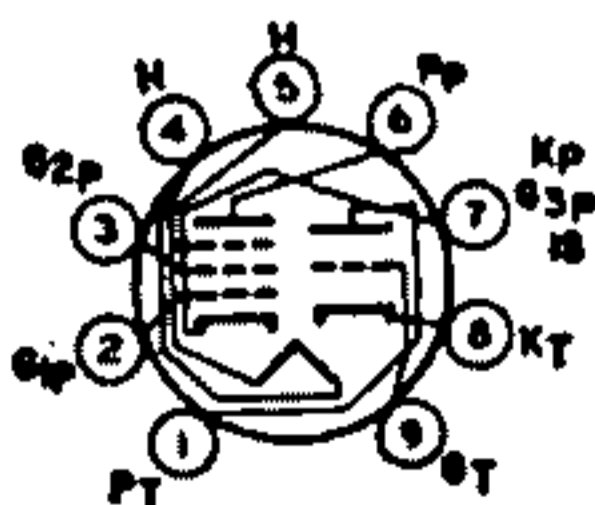
**8KA8**

Refer to type 6LC8.

**8LC8**

Refer to type 6LT8.

**8LT8**



**9A8**

**MEDIUM-MU TRIODE—  
SHARP-CUTOFF PENTODE**

**9A8  
9A8/  
PCF80**

Miniature types used as combined oscillator and mixer tubes in vhf color and black-and-white television receivers. Outlines section, 6B; require miniature 9-contact socket. Heater: volts (ac/dc), 9; amperes, 0.3; maximum heater-cathode volts, +100, -200 peak; -120 average.

**Class A<sub>1</sub> Amplifier**

MAXIMUM RATINGS (Design-Center Values)	Triode Unit	Pentode Unit	
Plate Supply Voltage	550	550	volts
Plate Voltage	250	250	volts
Grid-No.2 (Screen-Grid) Voltage	—	175	volts
Cathode Current	14	14	mA
Plate Dissipation	1.5	1.7	watts
Grid-No.2 Input	—	0.5	watt
<b>CHARACTERISTICS</b>			
Plate Voltage	100	170	volts
Grid-No.2 Voltage	—	170	volts
Grid-No.1 Voltage	—2	—2	volts
Amplification Factor	20	47*	
Plate Resistance (Approx.)	—	0.4	megohm
Transconductance	5000	6200	μmhos
Plate Current	14	10	mA
Grid-No.2 Current	—	2.8	mA
<b>MAXIMUM CIRCUIT VALUES</b>			
Grid-No.1-Circuit Resistance:			
For fixed-bias operation	0.5	0.5	megohm
For cathode-bias operation	0.5	1	megohm

\* Grid No.2 to Grid No.1.

**9AU7**

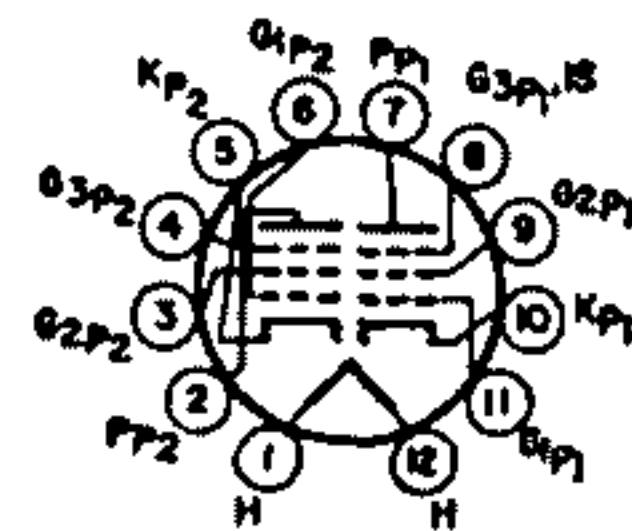
Refer to type 12AU7A.

**9BJ11**

**BEAM POWER TUBE—  
SHARP-CUTOFF PENTODE**

Duodecar type used in two-stage video-if-amplifier in television receivers. Pentode unit is used as the input stage and beam power unit as the output stage. Outlines section, 8B; requires duodecar 12-contact socket.

Heater Voltage (ac/dc)	9.6	volts
Heater Current	0.45	ampere
Heater Warm-up Time (Average)	11	seconds
Heater-Cathode Voltage:		
Peak value	±200 max	volts
Average value	100 max	volts
<b>Direct Interelectrode Capacitances:</b>		
<b>Pentode Unit:</b>		
Grid No.1 to Plate	0.008	pF
Grid No.1 to Cathode, Heater, Grid No.2, Grid No.3, Grid No.3 of Beam Power Unit, and Internal Shield	9.5	pF
Plate to Cathode, Heater, Grid No.2, Grid No.3, Grid No.3 of Beam Power Unit, and Internal Shield	3.4	pF
<b>Beam Power Unit:</b>		
Grid No.1 to Plate	0.016	pF
Grid No.1 to Cathode, Heater, Grid No.2, Grid No.3, and Internal Shield	8.5	pF
Plate to Cathode, Heater, Grid No.2, Grid No.3, and Internal Shield	3.0	pF



**12FU**

**Class A<sub>1</sub> Amplifier**

MAXIMUM RATINGS (Design-Maximum Values)	Pentode Unit	Beam Power Unit	
Plate Voltage	180	180	volts
Grid-No.3 (Suppressor-Grid) Voltage:			
Positive-bias value	10	0	volts
Negative-bias value	—50	—	volts
Grid-No.2 (Screen-Grid) Voltage	180	160	volts
Grid-No.1 (Control-Grid) Voltage, Positive-bias value	0	0	volts
Plate Dissipation	2.8	2.2	watts
Grid-No.2 Input	1.25	0.55	watts
<b>CHARACTERISTICS</b>			
Plate Supply Voltage	110	125	volts
Grid No.3	Connected to cathode at socket		
Grid-No.2 Voltage	110	125	volts
Grid-No.1 Resistor	0.1	—	megohm
Cathode-Bias Resistor	—	120	ohms
Plate Resistance (Approx.)	40000	40000	ohms
Transconductance	7500	9600	μmhos
Plate Current	5.8	8.5	mA
Grid-No.2 Input	6.8	2.5	mA
Grid-No.1 Voltage (Approx.) for plate current of 20 μA	—3	—4.5	volts



**MAXIMUM CIRCUIT VALUES**

Grid-No.1-Circuit Resistance .....	0.1	—	megohm
Grid-No.3-Circuit Resistance .....	1.5	—	megohm

Refer to chart at end of section.

**9BR7**

Refer to chart at end of section.

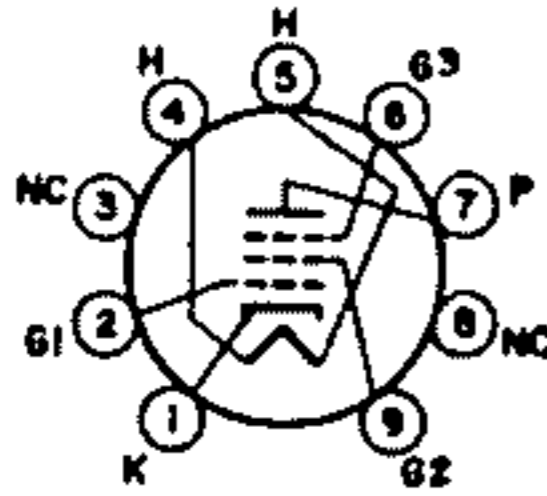
**9CL8**

Refer to type 6EA8.

**9EA8**

Refer to type 6GV8.

**9GV8**



**9RF**

**SHARP-CUTOFF PENTODE**

**9KC6**

Miniature type used as chroma bandpass amplifier, color demodulator, or video amplifier in color television receivers. Outlines section, 6E; requires miniature 9-contact socket. Heater: volts, 8.7; amperes, 0.45; warm-up time, 11 seconds; maximum heater-cathode voltage,  $\pm 200$  peak, 100 average.

**Class A<sub>1</sub> Amplifier**

**MAXIMUM RATINGS (Design-Maximum Values)**

Plate Voltage .....	400	volts
Grid-No.2 (Screen-Grid) Supply Voltage .....	330	volts
Grid-No.2 Voltage .....	See curve page 96	
Grid-No.3 (Suppressor-Grid) Voltage:		
Positive-bias value .....	0	volts
Negative-bias value .....	-100	volts
Grid-No.1 (Control-Grid) Voltage, Positive-bias value .....	0	volts
Plate Dissipation .....	7.0	watts
Grid-No.2 Input:		
For grid-No.2 voltages up to 165 volts .....	1.5	watts
For grid-No.2 voltages between 165 and 330 volts .....	See curve page 96	

**CHARACTERISTICS**

Plate Supply Voltage .....	250	250	50	volts
Grid-No.2 Voltage .....	150	100	100	volts
Grid-No.1 Voltage .....	0	-1.0	0	volts
Grid-No.3 Voltage (referred to negative end of cathode) .....	0	-25	—	volts
Cathode-Bias Resistor .....	56	0	—	ohms
Plate Current .....	18	1.0	25	mA
Grid-No.2 Current .....	9	13.0	25	mA
Transconductance:				
Grid No.1 to plate .....	24000	—	—	$\mu$ mhos
Grid No.3 to plate .....	500	—	—	$\mu$ mhos
Plate Resistance (Approx.) .....	55000	—	—	ohms
Grid-No.1 Voltage (Approx.) for plate current of 100 $\mu$ A .....	-4.1	—	—	volts

**MAXIMUM CIRCUIT VALUES**

Grid-No.1-Circuit Resistance:			
For fixed-bias operation .....	0.25	megohm	
For cathode-bias operation .....	0.5	megohm	
Grid-No.3-Circuit Resistance .....	1.0	megohm	

Refer to type 6KZ8.

**9KZ8**

Refer to type 6U8A.

**9U8A**

Refer to chart at end of section.

**10**

Refer to type 6AL11.

**10AL11**

Refer to chart at end of section.

**10C8**

Refer to type 6CW5.

**10CW5**

Refer to type 6DE7.

**10DE7**

Refer to type 6DR7.

**10DR7**

Refer to type 6DX8.

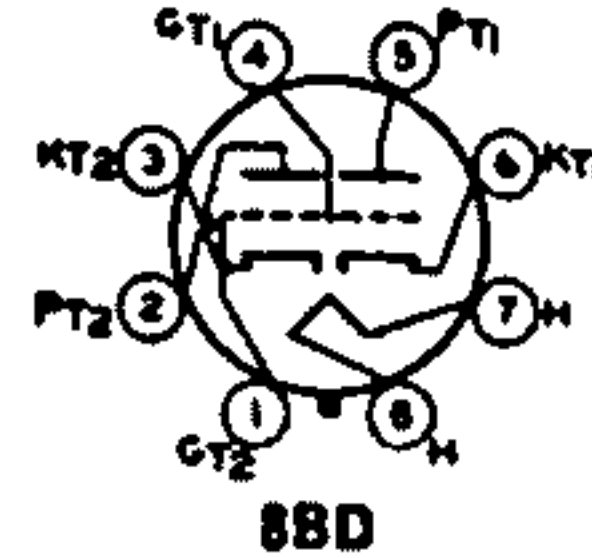
**10DX8**

**10DX8/LCL84**

# 10EG7

## DUAL TRIODE

Glass octal type used as combined vertical-deflection oscillator and vertical-deflection amplifier in television receivers. Outlines section, 13B; requires octal socket. Heater: volts (ac/dc), 9.7; amperes, 0.6; warm-up time (average), 11 seconds; maximum heater-cathode volts,  $\pm 200$  peak, 100 average. For maximum ratings and characteristics, refer to type 6EW7.

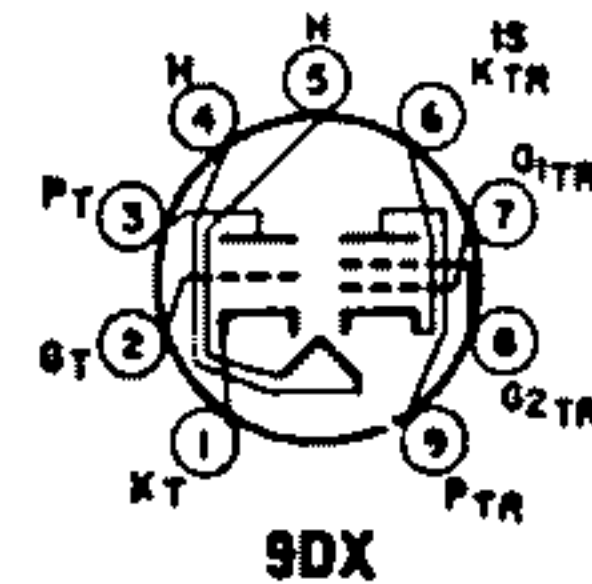


- 10EM7** Refer to type 6EM7.
- 10GF7** Refer to type 6GF7A.
- 10GF7A**
- 10GK6** Refer to type 6GK6.
- 10GN8** Refer to type 6GN8.
- 10HF8** Refer to type 6HF8.

# 10JA8

## HIGH-MU TRIODE— SHARP-CUTOFF TETRODE

Miniature type used in color and black-and-white television receiver applications. The triode unit is used as a sync separator, sync clipper, and phase inverter; the tetrode unit is used as a video amplifier. Outlines section, 6E; requires miniature 9-contact socket.



Heater Voltage (ac/dc)	10.5	volts
Heater Current	0.45	ampere
Heater Warm-up Time	11	seconds
Heater-Cathode Voltage:		
Peak value	$\pm 200$ max	volts
Average value	100 max	volts
Direct Interelectrode Capacitances:		
Triode Unit:		
Grid to Plate	4.0	pF
Grid to Cathode, Pentode Cathode, Heater, Pentode Grid No.3, and Internal Shield	2.6	pF
Plate to Cathode, Pentode Cathode, Heater, Pentode Grid No.3, and Internal Shield	2.6	pF
Pentode Unit:		
Grid No.1 to Plate	0.1 max	pF
Grid No.1 to Cathode, Heater, Grid No.2, Grid No.3, and Internal Shield	11	pF
Plate to Cathode, Heater, Grid No.2, Grid No.3, and Internal Shield	4.4	pF
Grid No.1 to Triode Plate	0.005 max	pF
Plate to Triode Grid	0.018 max	pF
Plate to Triode Plate	0.17 max	pF

### Class A<sub>1</sub> Amplifier

MAXIMUM RATINGS (Design-Maximum Values)	Triode Unit		Tetrode Unit			
	300	330	330	330		
Plate Voltage	300	330	330	330	volts	
Grid-No.2 (Screen-Grid) Supply Voltage	—	—	—	—	volts	
Grid-No.2 Voltage	—	—	See curve page 96	See curve page 96		
Grid-No.1 (Control-Grid) Voltage, Positive-bias value	0	0	0	0	volts	
Plate Dissipation	1	1	5	5	watts	
Grid-No.2 Input:						
For grid-No.2 voltages up to 165 volts	—	—	1.5	1.5	watts	
For grid-No.2 voltages between 165 and 330 volts	—	—	See curve page 96	See curve page 96		
CHARACTERISTICS	Triode Unit		Tetrode Unit			
Plate Voltage	135	200	30	135	200	volts
Grid-No.2 Voltage	—	—	135	135	135	volts
Grid-No.1 Voltage	—2	—2	0	—1.5	—1.5	volts
Amplification Factor	60	70	—	—	—	
Plate Resistance	23000	17000	—	6600	7000	ohms
Transconductance	2600	4000	—	12600	14000	μmhos

Plate Current .....	2	4	32*	17	18	mA
Grid-No.2 Current .....	—	—	14*	4.2	4	mA
Grid-No.1 Voltage (Approx.) for plate current of 10 $\mu$ A	-4.8	-7	—	-5	-5	volts

**MAXIMUM CIRCUIT VALUES**

Grid-No.1-Circuit Resistance:		Triode Unit	Tetrad Unit	
For fixed-bias operation .....		0.5	0.25	megohm
For cathode-bias operation .....		1	1	megohm

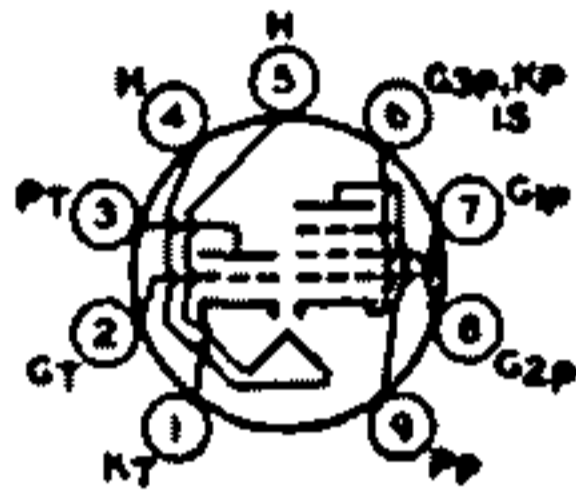
\* This value can be measured by a method involving a recurrent waveform such that the maximum ratings of the tube will not be exceeded.

Refer to type 6JT8.

10JT8

**MEDIUM-MU TRIODE—  
SHARP-CUTOFF PENTODE**

**10JY8**



9DX

Miniature type used in television receiver applications. The pentode unit is used as a video amplifier, and the triode unit as a sync separator. Outlines section, 6E; requires miniature 9-contact socket. Heater: volts (ac/dc), 10.5; amperes, 0.45; warm-up time (average), 11 seconds; maximum heater-cathode volts,  $\pm 200$  peak, 100 average ( $-300$  peak,  $-200$  average for triode unit).

**Class A<sub>1</sub> Amplifier**

**MAXIMUM RATINGS (Design-Maximum Values)**

Plate Voltage .....	330	330	volts
Grid-No.2 (Screen-Grid) Supply Voltage .....	—	330	volts
Grid-No.2 Voltage .....	—	See curve page 96	
Grid-No.1 (Control-Grid) Voltage, Positive-bias value .....	0	0	volts
Plate Dissipation .....	2	5	watts
Grid-No.2 Input:			
For grid-No.2 voltages up to 165 volts .....	—	1.1	watts
For grid-No.2 voltages between 165 and 330 volts .....	—	See curve page 96	

Triode Unit	Pentode Unit	
330	330	volts
—	330	volts
—	See curve page 96	
0	0	volts
2	5	watts
—	1.1	watts
—	See curve page 96	

**CHARACTERISTICS**

Plate Voltage .....	125	50	200	volts
Grid-No.2 Voltage .....	—	150	150	volts
Grid-No.1 Voltage .....	—	0	—	volts
Cathode-Bias Resistor .....	68	—	100	ohms
Amplification Factor .....	46	—	—	
Plate Resistance (Approx.) .....	4400	—	55000	ohms
Transconductance .....	10400	—	11000	$\mu$ mhos
Plate Current .....	15	60*	24	mA
Grid-No.2 Current .....	—	18*	4.8	mA
Grid Voltage (Approx.) for plate current of 10 $\mu$ A ..	-8	—	-10	volts

125	50	200	volts
—	150	150	volts
—	0	—	volts
68	—	100	ohms
46	—	—	
4400	—	55000	ohms
10400	—	11000	$\mu$ mhos
15	60*	24	mA
—	18*	4.8	mA
-8	—	-10	volts

**MAXIMUM CIRCUIT VALUES**

Grid-No.1-Circuit Resistance:			
For fixed-bias operation .....	0.5	0.25	megohm
For cathode-bias operation .....	1	1	megohm

\* This value can be measured by a method involving a recurrent waveform such that the maximum ratings of the tube will not be exceeded.

Refer to type 6KR8.

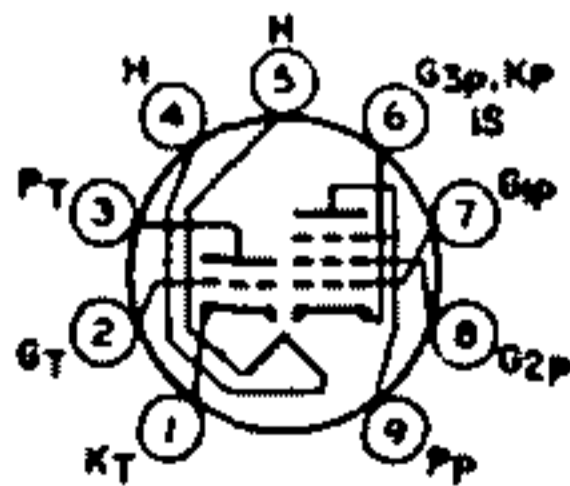
10KR8

Refer to type 6KU8.

10KU8

Refer to type 6LE8.

10LE8



9DX

**HIGH-MU TRIODE—  
SHARP-CUTOFF PENTODE**

**10LW8**

Miniature type used in television receivers applications. The pentode unit is used as a video amplifier, and the triode unit for general-purpose use. Outlines section, 6E; requires miniature 9-contact socket. Heater: volts (ac/dc), 10.5; amperes, 0.45; average warm-up time, 11 seconds; maximum heater-cathode volts,  $\pm 200$  peak, 100 average.



**Class A<sub>1</sub> Amplifier**

**MAXIMUM RATINGS (Design-Maximum Values)**

	Triode Unit	Pentode Unit	
Plate Voltage .....	330	330	volts
Grid-No.2 (Screen-Grid) Supply Voltage .....	—	330	volts
Grid-No.2 Voltage .....	See curve page 96		
Grid-No.1 (Control-Grid) Voltage, Positive-bias value .....	0	0	volts
Plate Dissipation .....	1.5	4.0	watts
Grid-No.2 Input:			
For grid-No.2 voltages up to 165 volts .....	—	1.5	watts
For grid-No.2 voltages between 165 and 330 volts .....	See curve page 96		

**CHARACTERISTICS**

	Triode Unit	Pentode Unit	
Plate Supply Voltage .....	200	35	200
Grid-No.2 Supply Voltage .....	—	100	100
Grid-No.1 Voltage .....	—2.0	0	—
Cathode-Bias Resistor .....	—	—	82
Amplification Factor .....	75	—	—
Plate Resistance (Approx.) .....	18700	—	60000
Transconductance .....	4000	—	19000
Plate Current .....	2.6	48	16.6
Grid-No.2 Current .....	—	12.5	2.8
Grid Voltage (Approx.) for plate current of 30 $\mu$ A .....	—4	—	—
Grid-No.1 Voltage (Approx.) for plate current of 100 $\mu$ A .....	—	—	—5.5

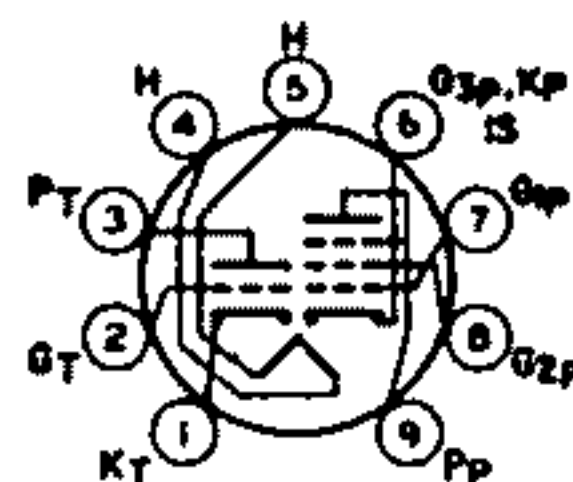
**MAXIMUM CIRCUIT VALUES**

Grid-No.1-Circuit Resistance:	Triode Unit	Pentode Unit	
For fixed-bias operation .....	0.5	0.5	megohm
For cathode-bias operation .....	1.0	1.0	megohm

**10LZ8**

**HIGH-MU TRIODE—  
SHARP-CUTOFF PENTODE**

Miniature type used in television receiver applications. The pentode unit is used as a video amplifier, and the triode unit for general-purpose use. Outlines section, 6E; requires miniature 9-contact socket. Heater: volts (ac/dc), 10.5; amperes, 0.45; warm-up time, 11 seconds; maximum heater-cathode volts,  $\pm$ 200 peak, 100 average.



**9DX**

**Class A<sub>1</sub> Amplifier**

**MAXIMUM RATINGS (Design-Maximum Values)**

	Triode Unit	Pentode Unit	
Plate Voltage .....	300	225	volts
Grid-No.2 (Screen-Grid) Voltage .....	—	160	volts
Grid-No.1 (Control-Grid) Voltage, Positive-bias value .....	0	0	volts
Plate Dissipation .....	1.0	4.5	watts
Grid-No.2 Input .....	—	2.0	watts

**CHARACTERISTICS**

	Triode Unit	Pentode Unit	
Plate Supply Voltage .....	250	30	30
Grid-No.2 Supply Voltage .....	—	140	140
Grid-No.1 Voltage .....	—2.0	0	—1.0
Amplification Factor .....	110	—	—
Plate Resistance (Approx.) .....	52000	—	150000
Transconductance .....	2100	—	11000
Plate Current .....	1.1	30	16
Grid-No.2 Current .....	—	13.6	9.5
Grid Voltage (Approx.) for plate current of 10 $\mu$ A .....	—3.6	—	—
Grid-No.1 Voltage (Approx.) for plate current of 500 $\mu$ A .....	—	—	—4.2

**MAXIMUM CIRCUIT VALUES**

Grid-No.1-Circuit Resistance:	Triode Unit	Pentode Unit	
For fixed-bias operation .....	0.5	0.5	megohm
For cathode-bias operation .....	1.0	1.0	megohm

**11**

Refer to chart at end of section.

**11AR11**

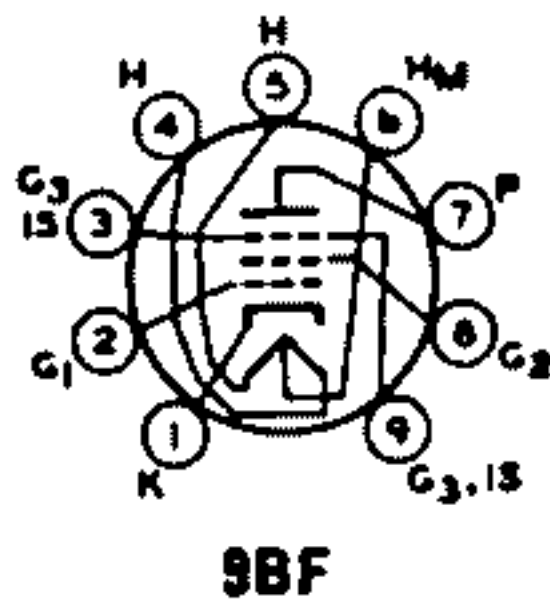
Refer to type 6AR11.

**11BQ11**

Refer to type 8BQ11.

**11CY7**

Refer to type 6CY7.



## SHARP-CUTOFF PENTODE 11HM7

Miniature type used as video output amplifier in color television receivers. Outlines section, 6E; requires miniature 9-contact socket.

Heater Arrangement .....	Series	Parallel	
Heater Voltage (ac/dc) .....	11.0	6.50	volts
Heater Current .....	0.3	0.6	ampere
Heater-Cathode Voltage:			
Peak value .....		±200 max	volts
Average value .....		100 max	volts
Direct Interelectrode Capacitances:			
Grid No.1 to Plate .....		0.15 max	pF
Grid No.1 to Cathode, Heater, Grid No.2, Grid No.3, and Internal Shield .....		14	pF
Grid No.1 to Cathode, Heater, Grid No.2, Grid No.3, and Internal Shield .....		5	pF

### Class A<sub>1</sub> Amplifier

#### MAXIMUM RATINGS (Design-Maximum Values)

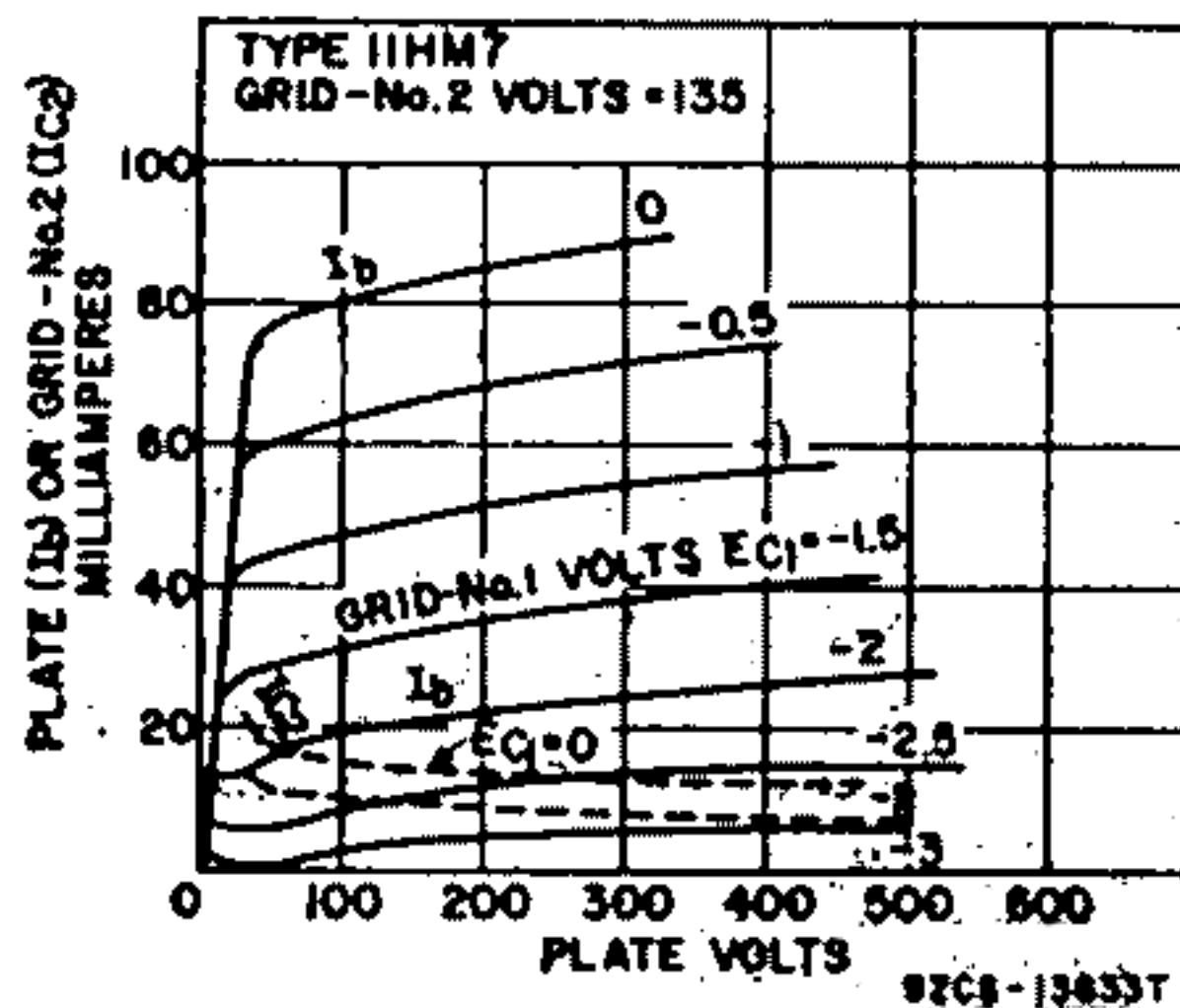
Plate Voltage .....	330	volts
Grid-No.2 (Screen-Grid) Supply Voltage .....	330	volts
Grid-No.2 Voltage .....	See curve page 96	
Grid-No.1 (Control-Grid) Voltage, Positive-bias value .....	0	volts
Plate Dissipation .....	7	watts
Grid-No.2 Input:		
For grid-No.2 voltages up to 165 volts .....	1	watt
For grid-No.2 voltages between 165 and 330 volts .....	See curve page 96	

#### CHARACTERISTICS

Plate Supply Voltage .....	200	volts
Grid-No.3 Voltage .....	0	volts
Grid-No.2 Voltage .....	135	volts
Cathode-Bias Resistor .....	47	ohms
Plate Resistance (Approx.) .....	40000	ohms
Transconductance .....	30000	μmhos
Plate Current .....	30	mA
Grid-No.2 Current .....	5.2	mA
Grid-No.1 Voltage (Approx.) for plate current of 100 μA .....	-4.5	volts

#### MAXIMUM CIRCUIT VALUES

Grid-No.1-Circuit Resistance:		
For fixed-bias operation .....	0.1	megohm
For cathode-bias operation .....	0.25	megohm



11JE8

Refer to type 6JE8.

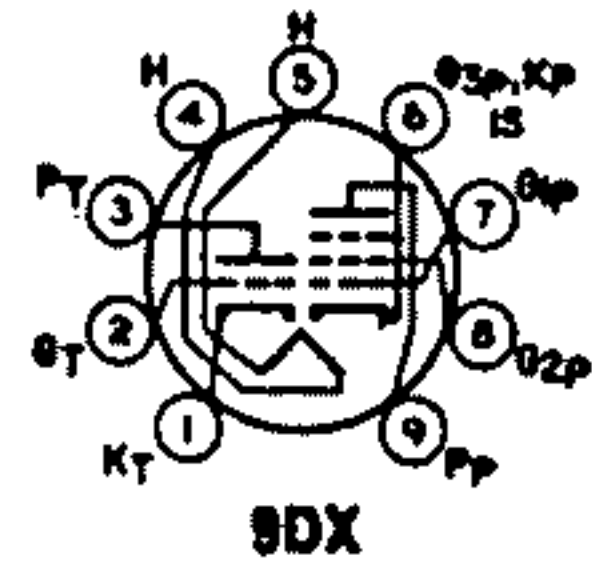
11KV8

Refer to type 6KV8.

# 11LQ8

## MEDIUM-MU TRIODE— SHARP-CUTOFF PENTODE

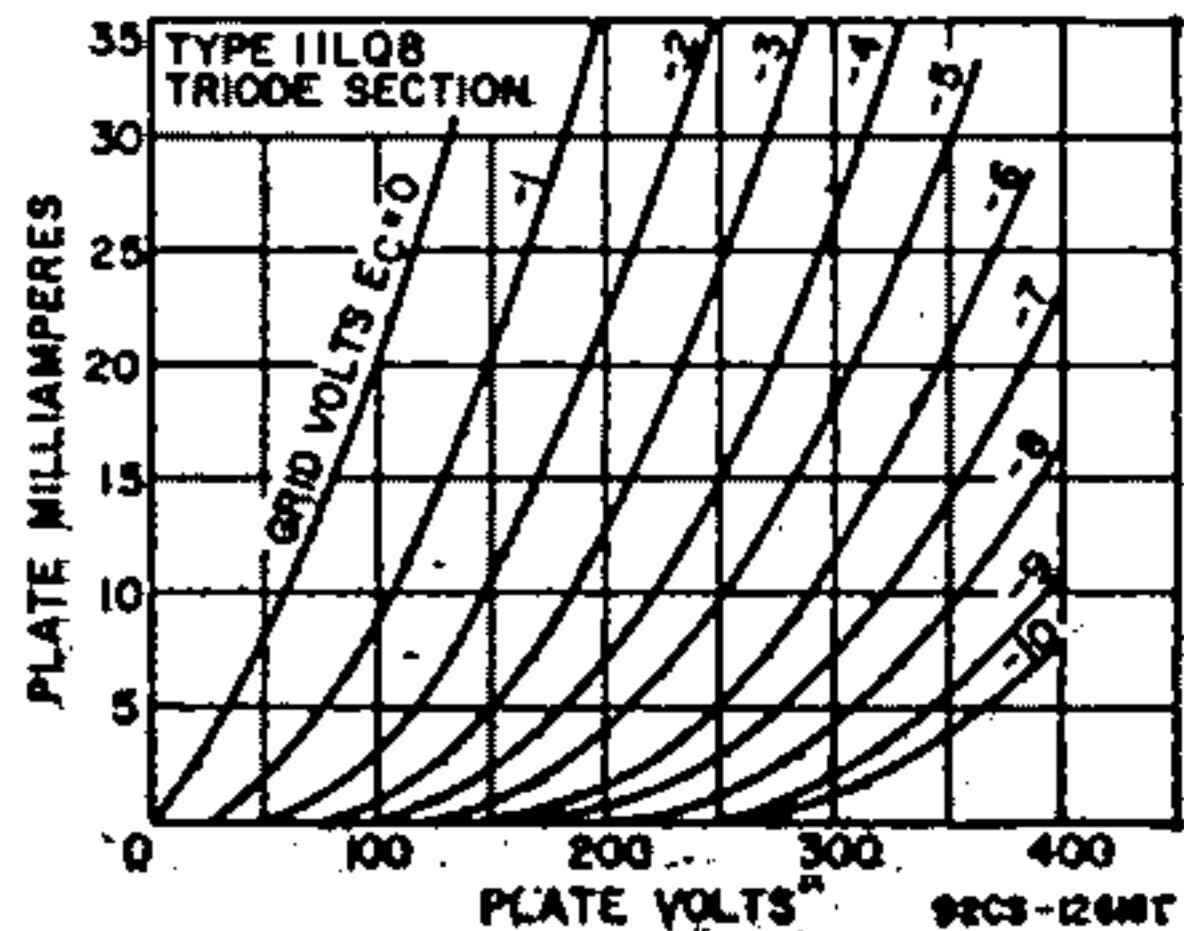
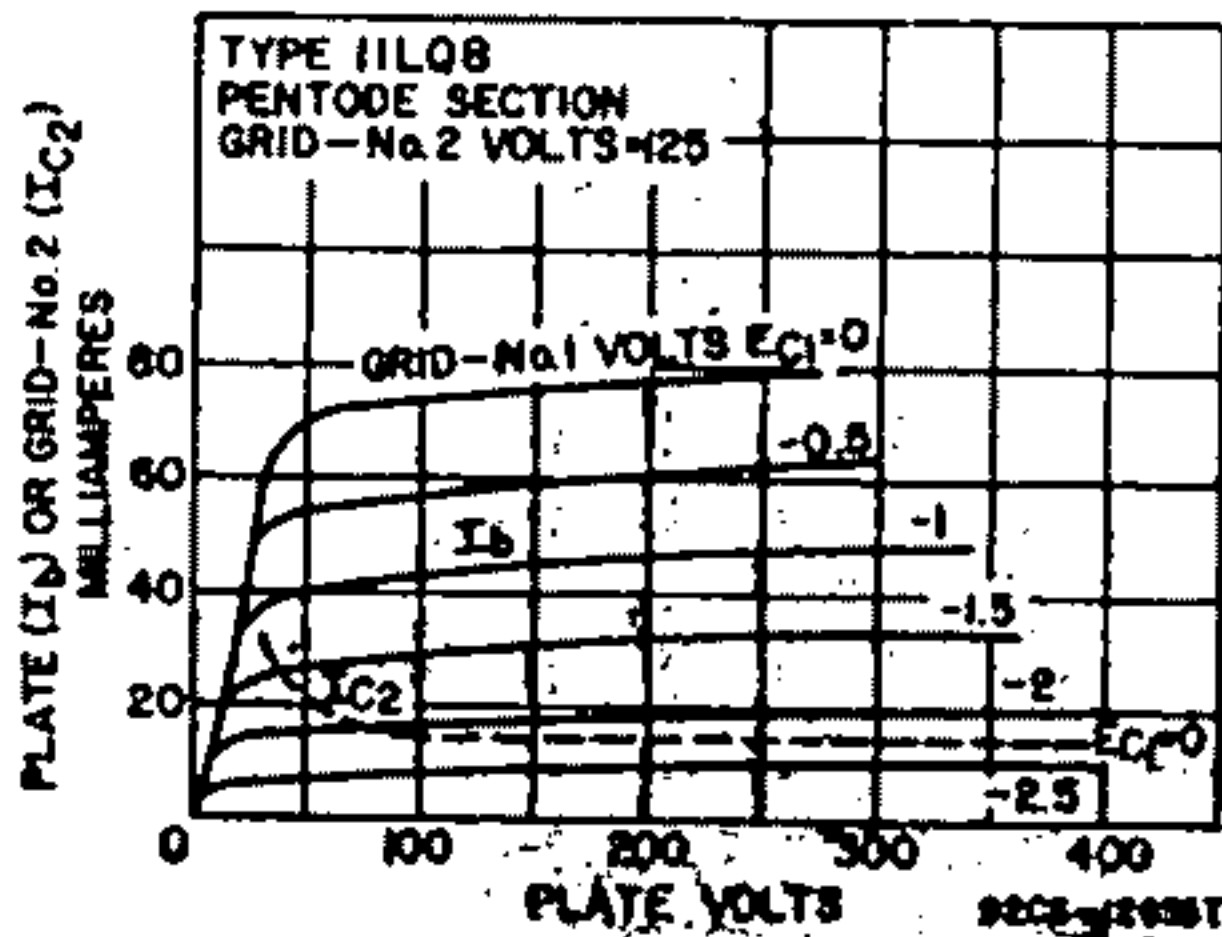
Miniature type with frame-grid pentode used in black-and-white television receivers. The triode unit is used in general-purpose voltage-amplifier circuits. The pentode unit is used in video-output circuits. Outlines section, 6E; requires miniature 9-contact socket.



Heater Voltage (ac/dc)	10.9	volts
Heater Current	0.45	ampere
Heater Warm-up Time (Average)	11	seconds
Heater-Cathode Voltage:		
Peak value	±200 max	volts
Average value	100 max	volts
Direct Interelectrode Capacitances (Approx.):		
Triode Unit:		
Grid to Plate	2.8	pF
Grid to Triode Cathode, Pentode Cathode, Heater, Pentode Grid No.3, and Internal Shield	4.2	pF
Plate to Triode Cathode, Pentode Cathode, Heater, Pentode Grid No.3, and Internal Shield	2.4	pF
Pentode Unit:		
Grid No.1 to Plate	0.12 max	pF
Grid No.1 to Cathode, Heater, Grid No.2, Grid No.3, and Internal Shield	14	pF
Plate to Cathode, Heater, Grid No.2, Grid No.3, and Internal Shield	4.8	pF
Triode Grid to Pentode Plate	0.016 max	pF
Pentode Plate to Triode Plate	0.17 max	pF

### Class A<sub>1</sub> Amplifier

<b>MAXIMUM RATINGS (Design-Maximum Values)</b>	<b>Triode Unit</b>	<b>Pentode Unit</b>	
Plate Voltage	300	300	volts
Grid-No.2 (Screen-Grid) Supply Voltage	—	300	volts
Grid-No.2 Voltage	—	See curve page 96	
Grid-No.1 (Control-Grid) Voltage, Positive-bias value	0	0	volts
Plate Dissipation	2	6	watts
Grid-No.2 Input:			
For grid-No.2 voltages up to 150 volts	—	1	watt
For grid-No.2 voltages between 150 and 300 volts	—	See curve page 96	
<b>MAXIMUM CIRCUIT VALUES</b>	<b>Triode Unit</b>	<b>Pentode Unit</b>	
Plate Supply Voltage	125	125	200
Grid-No.2 Supply Voltage	—	125	125
Cathode-Bias Resistor	68	82	68
Amplification Factor	46	—	—
Plate Resistance (Approx.)	4400	55000	75000
Transconductance	10400	21000	25000
Plate Current	15	16.5	20
Grid-No.2 Current	—	3.1	3.5
Grid-No.1 Voltage (Approx.) for plate current of 100 μA	-6	-4.2	-4.2





**CHARACTERISTICS**

	<b>Triode Unit</b>	<b>Pentode Unit</b>	
Grid-No.1-Circuit Resistance:			
For fixed-bias operation .....	0.5	0.1	megohm
For cathode-bias operation .....	1	0.25	megohm

Refer to type 6Y9.

Refer to chart at end of section.  
 Refer to chart at end of section.  
 Refer to chart at end of section.  
 Refer to chart at end of section.

**11Y9**  
**12**  
**12A5**  
**12A7**  
**12ABGT**



**BEAM POWER TUBE**

**12AB5**

Miniature type used in the output stage of automobile radio receivers operating from a 12-volt storage battery. Outlines section, 6E; requires miniature 9-contact socket.

Heater-Voltage Range (ac/dc) .....	10.0 to 15.9	volts
Heater Current (Approx.) at 12.6 volts .....	0.2	ampere
Peak Heater-Cathode Voltage .....	±90 max	volts
Direct Interelectrode Capacitances:		
Grid No.1 to Plate .....	0.7 max	pF
Grid No.1 to Cathode, Heater, Grid No.2, and Grid No.3 .....	8	pF
Plate to Cathode, Heater, Grid No.2, and Grid No.3 .....	8.5	pF

\* For longest life, it is recommended that the heater be operated within the voltage range of 11 to 14 volts.

**Class A<sub>1</sub> Amplifier**

**MAXIMUM RATINGS (Design-Center Values)**

Plate Voltage .....	315	volts
Grid-No.2 (Screen-Grid) Voltage .....	285	volts
Plate Dissipation .....	12	watts
Grid-No.2 Input .....	2	watts
Bulb Temperature (At hottest point) .....	250	°C

**TYPICAL OPERATION WITH 12.6 VOLTS ON HEATER**

Plate Supply Voltage .....	250	250	volts
Grid-No.2 Supply Voltage .....	200	250	volts
Grid-No.1 (Control-Grid) Voltage .....	—	-12.5	volts
Cathode-Bias Resistor .....	270	—	ohms
Peak AF Grid-No.1 Voltage .....	10.5	12.5	volts
Zero-Signal Plate Current .....	38.5	45	mA
Maximum-Signal Plate Current .....	36	47	mA
Zero-Signal Grid-No.2 Current .....	1.6	4.5	mA
Maximum-Signal Grid-No.2 Current .....	3.2	7	mA
Plate Resistance (Approx.) .....	75000	50000	ohms
Transconductance .....	4000	4100	μmhos
Load Resistance .....	6000	5000	ohms
Total Harmonic Distortion .....	8	8	per cent
Maximum-Signal Power Output .....	3.3	4.5	watts

**MAXIMUM CIRCUIT VALUES**

Grid-No.1-Circuit Resistance:			
For fixed-bias operation .....		0.1	megohm
For cathode-bias operation .....		0.5	megohm

**Push-Pull Class AB<sub>1</sub> Amplifier**

**MAXIMUM RATINGS (Same as for Single-Tube Class A<sub>1</sub> Amplifier)**

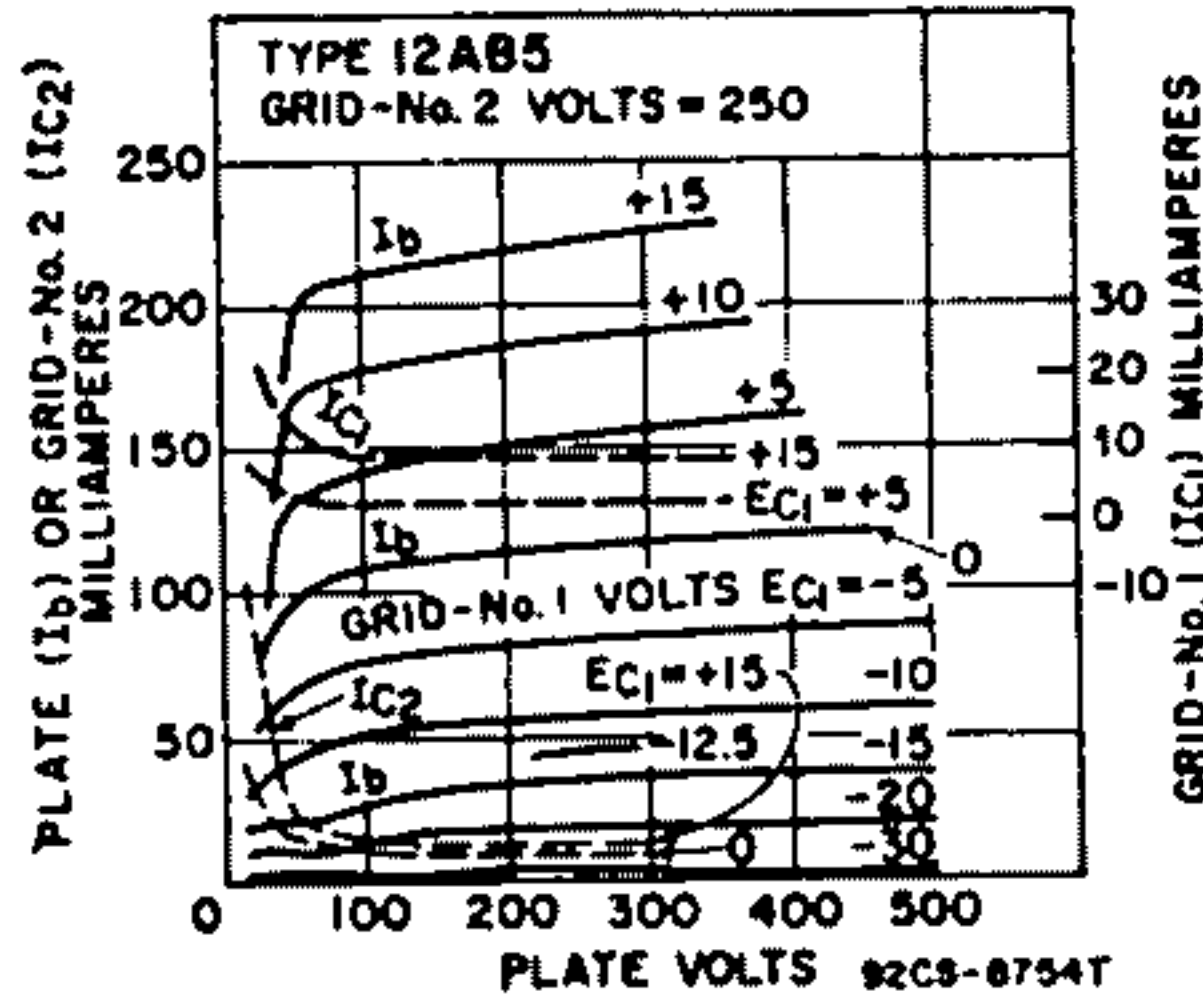
**TYPICAL OPERATION WITH 12.6 VOLTS ON HEATER (Values are for two tubes)**

Plate Voltage .....	250	volts
Grid-No.2 Voltage .....	250	volts
Grid-No.1 Voltage .....	-15	volts
Peak AF Grid-No.1-to-Grid-No.1 Voltage .....	30	volts
Zero-Signal Plate Current .....	70	mA
Maximum-Signal Plate Current .....	79	mA
Zero-Signal Grid-No.2 Current .....	5	mA
Maximum-Signal Grid-No.2 Current .....	13	mA
Effective Load Resistance (Plate-to-Plate) .....	10000	ohms
Total Harmonic Distortion .....	5	per cent
Maximum-Signal Power Output .....	10	watts

**MAXIMUM CIRCUIT VALUES**

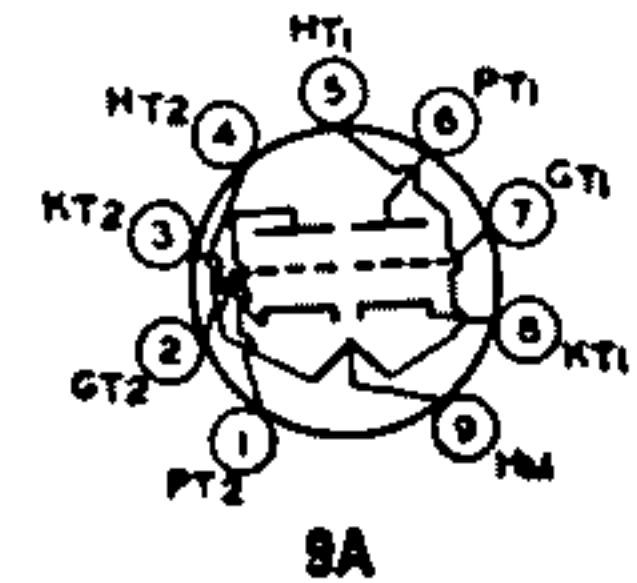
Grid-No.1-Circuit Resistance:

For fixed-bias operation .....	0.1	megohm
For cathode-bias operation .....	0.5	megohm



- 12AC6 Refer to chart at end of section.
- 12AD6 Refer to chart at end of section.
- 12AE6 Refer to chart at end of section.
- 12AE6A Refer to chart at end of section.
- 12AE7 Refer to chart at end of section.
- 12AF3 Refer to type 6AF3.
- 12AF6 Refer to chart at end of section.
- 12AH7GT Refer to chart at end of section.
- 12AJ6 Refer to chart at end of section.
- 12AL5 Refer to type 6AL5.
- 12AL8 Refer to chart at end of section.
- 12AL11 Refer to type 6AL11.
- 12AQ5 Refer to type 6AQ5A.
- 12AT6 Refer to type 6AT6.

**12AT7  
12AT7/  
ECC81** HIGH-MU TWIN TRIODE



Miniature types used as push-pull cathode-drive amplifiers or frequency converters in the FM and television broadcast bands. Outlines section, 6B; require miniature 9-contact socket. Each triode unit is independent of the other except for the common heater. For typical operation as a resistance-coupled amplifier, refer to Resistance-Coupled Amplifier section.

Heater Arrangement:	Series	Parallel	
Heater Voltage (ac/dc) .....	12.6	6.3	volts
Heater Current .....	0.15	0.3	ampere
Peak Heater-Cathode Voltage .....		±90 max	volts

Direct Interelectrode Capacitances:

Grid-Drive Operation:		
Grid to Plate (Each unit) .....	1.5	pF
Grid to Cathode and Heater (Each unit) .....	2.2	pF
Plate to Cathode and Heater:		
Unit No.1 .....	0.5	pF
Unit No.2 .....	0.4	pF
Cathode-Drive Operation:		
Cathode to Plate (Each unit) .....	0.2	pF
Cathode to Grid and Heater (Each unit) .....	4.6	pF
Plate to Grid and Heater (Each unit) .....	1.8	pF
Heater to Cathode (Each Unit) .....	2.4	pF

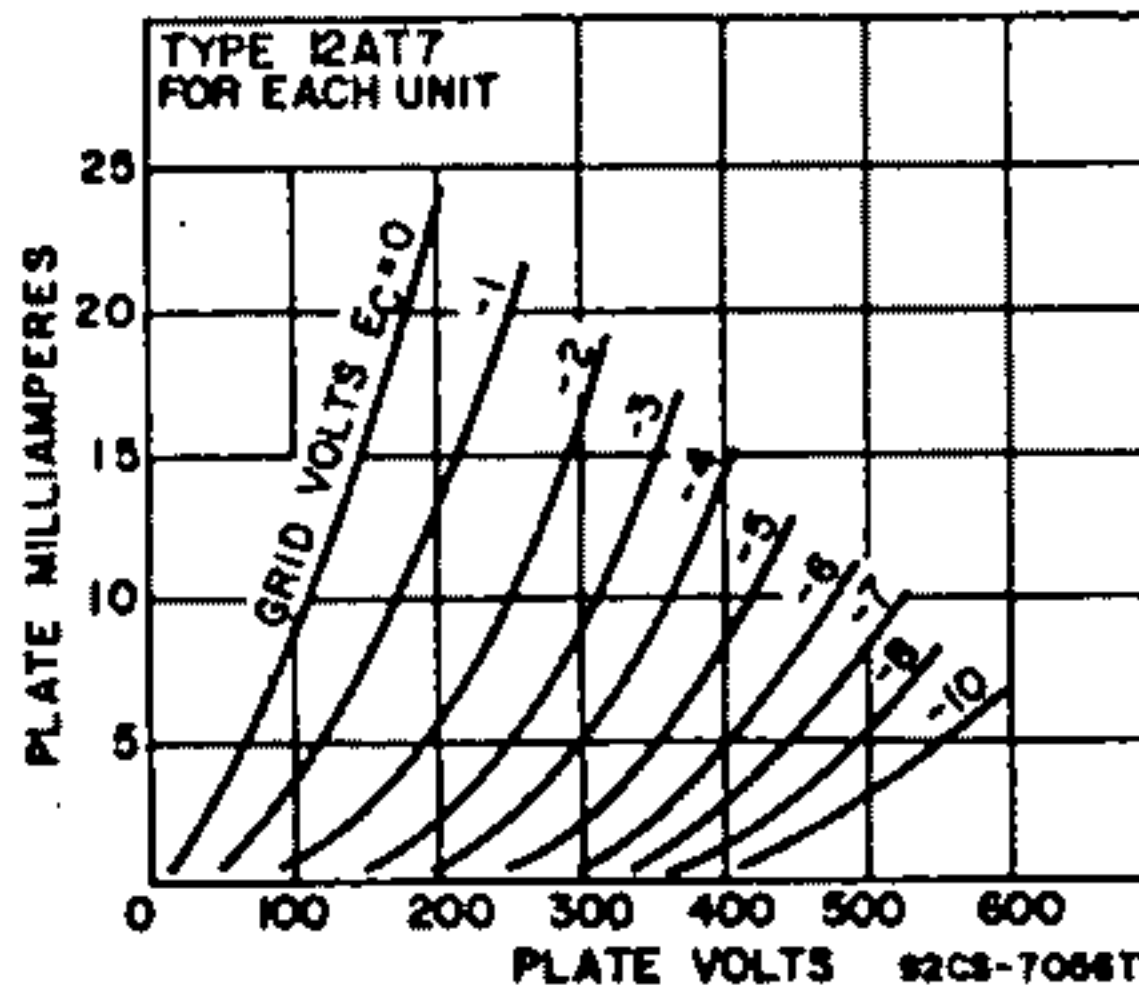
Class A<sub>1</sub> Amplifier (Each Unit)

MAXIMUM AND MINIMUM RATINGS (Design-Center Values)

Plate Voltage .....	300	volts
Grid Voltage, Negative-bias value .....	-50	volts
Plate Dissipation .....	2.5	watts

CHARACTERISTICS

Plate Supply Voltage .....	100	250	volts
Cathode-Bias Resistor .....	270	200	ohms
Amplification Factor .....	60	60	
Plate Resistance (Approx.) .....	15000	10900	ohms
Transconductance .....	4000	5500	μmhos
Grid Voltage (Approx.) for plate current of 10 μA .....	-5	-12	volts
Plate Current .....	3.7	10	mA



Refer to type 6AU6A.

Refer to chart at end of section.

12AU6

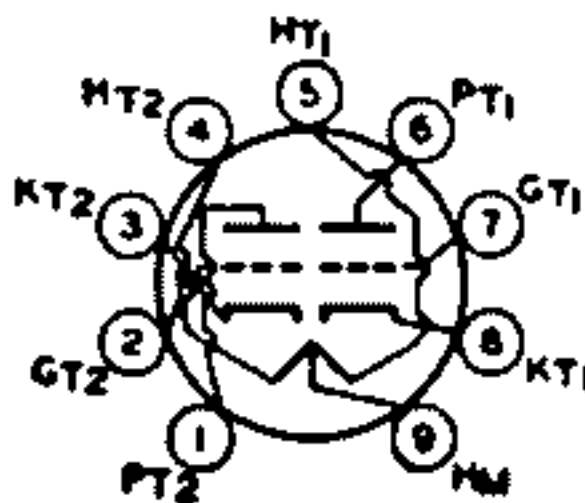
12AU7

12AU7A

12AU7A/

ECC82

7AU7, 9AU7



9A

MEDIUM-MU TWIN TRIODE

Miniature types used as phase inverters or push-pull amplifiers in ac/dc radio equipment and as multivibrators or oscillators in industrial control devices. Also used as combined vertical oscillators and vertical-deflection amplifiers, and as horizontal-deflection oscillators, in color and black-and-white television receivers. Outlines section, 6B; require miniature 9-contact socket. Each triode unit is independent of the other except for the common heater. For typical operation as a resistance-coupled amplifier, refer to Resistance-Coupled Amplifier section. Types 7AU7 and 9AU7 are identical with type 12AU7 and 12AU7A/ECC82 except for heater ratings.



	7AU7	9AU7	12AU7A 12AU7A/ ECC92	
<b>Heater Voltage (ac/dc):</b>				
Series .....	7	9.4	12.6	volts
Parallel .....	3.5	4.7	6.3	volts
<b>Heater Current:</b>				
Series .....	0.3	0.225	0.15	ampere
Parallel .....	0.6	0.45	0.3	ampere
<b>Heater Warm-up Time (Parallel, Average) ..</b>				
	11	11	—	seconds
<b>Heater-Cathode Voltage:</b>				
Peak value .....	±200 max	±200 max	±200 max	volts
Average value .....	100 max	100 max	100 max	volts
<b>Direct Interelectrode Capacitances (Approx.):</b>				
	Unit No.1	Unit No.2		
Grid to Plate .....	1.5	1.5		pF
Grid to Cathode and Heater .....	1.6	1.6		pF
Plate to Cathode and Heater .....	0.5	0.35		pF

**Class A<sub>1</sub> Amplifier (Each Unit Unless Otherwise Specified)**

**MAXIMUM RATINGS (Design-Maximum Values)**

Plate Voltage .....	330	volts
Cathode Current .....	22	mA
<b>Plate Dissipation:</b>		
Each Plate .....	2.75	watts
Both Plates (Both units operating) .....	5.5	watts

**CHARACTERISTICS**

Plate Voltage .....	100	250	volts
Grid Voltage .....	0	-8.5	volts
Amplification Factor .....	19.5	17	
Plate Resistance (Approx.) .....	6250	7700	ohms
Transconductance .....	8100	2200	μmhos
Plate Current .....	11.8	10.5	mA
Grid Voltage (Approx.) for plate current of 10 μA .....	—	-24	volts

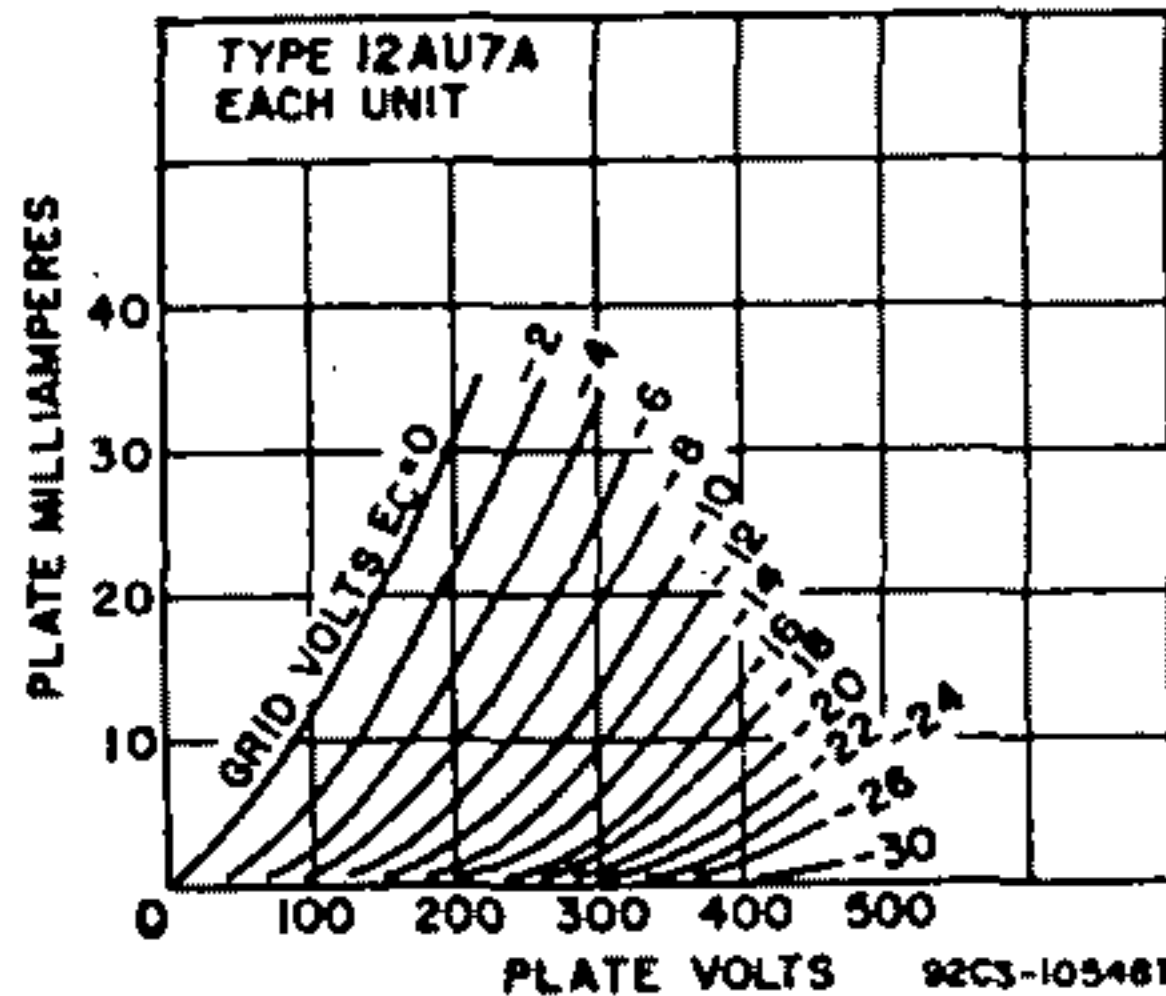
**MAXIMUM CIRCUIT VALUES**

<b>Grid-Circuit Resistance:</b>		
For fixed-bias operation .....	0.25	megohm
For cathode-bias operation .....	1.0	megohm

**Oscillator (Each Unit Unless Otherwise Specified)**

For operation in a 525-line, 30-frame system

	Vertical-Deflection Oscillator	Horizontal-Deflection Oscillator	
<b>MAXIMUM RATINGS (Design-Maximum Values)</b>			
DC Plate Voltage .....	330	330	volts
Peak Negative-Pulse Grid Voltage .....	-440	-660	volts
Peak Cathode Current .....	68	330	mA
Average Cathode Current .....	22	22	mA
<b>Plate Dissipation:</b>			
Each Plate .....	2.75	2.75	watts
Both Plates (Both units operating) .....	5.5	5.5	watts
<b>MAXIMUM CIRCUIT VALUES</b>			
Grid-Circuit Resistance .....	2.2	2.2	megohms



**Vertical-Deflection Amplifier (Each Unit Unless Otherwise Specified)**

For operation in a 525-line, 30-frame system

<b>MAXIMUM RATINGS (Design-Maximum Values)</b>		
DC Plate Voltage .....	330	volts

Peak Positive-Pulse Plate Voltage#	1200	volts
Peak Negative-Pulse Grid Voltage	-275	volts
Peak Cathode Current	66	mA
Average Cathode Current	22	mA
Plate Dissipation:		
Each Plate	2.75	watts
Both Plates (Both units operating)	5.5	watts
<b>MAXIMUM CIRCUIT VALUE</b>		
Grid-Circuit Resistance, for cathode-bias operation	2.2	megohms

# Pulse duration must not exceed 15% of a vertical scanning cycle (2.5 milliseconds).

Refer to type 6AV5GA.

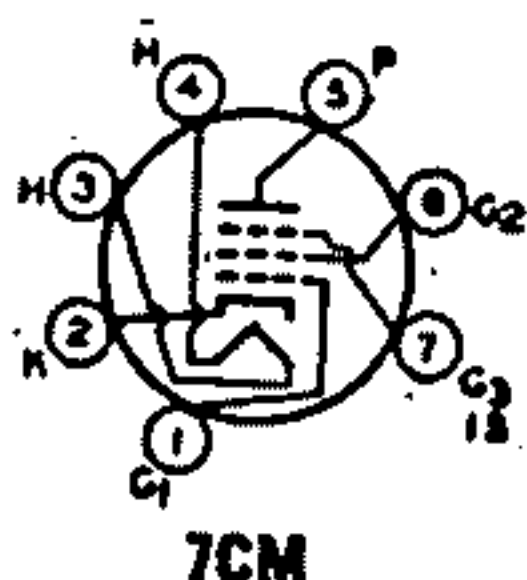
**12AV5GA**

Refer to type 6AV6.

**12AV6**

Refer to chart at end of section.

**12AV7**



**7CM**

**SHARP-CUTOFF PENTODE 12AW6**

Miniature type used as an rf or if amplifier up to 400 MHz in compact ac/dc FM receivers. Outlines section, 5C; requires miniature 7-contact socket. Heater: volts (ac/dc), 12.6; amperes, 0.15. Except for heater ratings and terminal connections, this type is identical with miniature type 6AG5.

Refer to type 6AX3.

**12AX3**

Refer to chart at end of section.

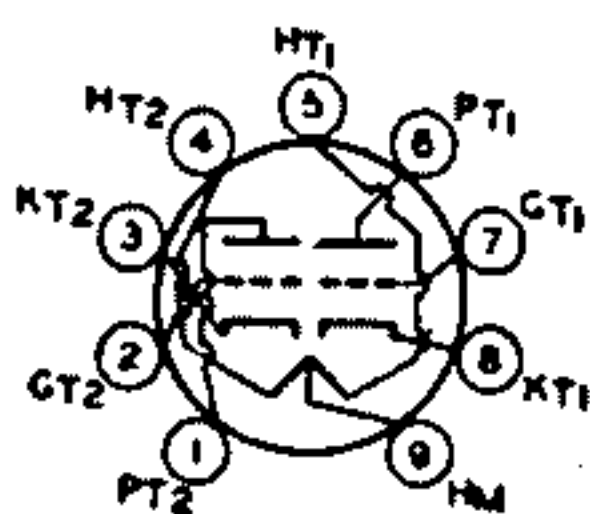
**12AX4GT  
12AX4GTA**

Refer to type 6AX4GTB.

**12AX4GTB**

Refer to chart at end of section.

**12AX7**



**9A**

**HIGH-MU TWIN TRIODE 12AX7A  
12AX7A/  
ECC83**

Miniature types used as phase inverters or twin resistance-coupled amplifiers in radio equipment. Outlines section, 6B; require miniature 9-contact socket. Each triode unit is independent of the other except for common heater. For characteristics and curves, refer to type 6AV6. For typical operation as a resistance-coupled amplifier, refer to Resistance-Coupled Amplifier section.

Heater Arrangement:	Series	Parallel	
Heater Voltage (ac/dc)	12.6	6.3	volts
Heater Current	0.15	0.3	ampere
Heater-Cathode-Voltage:			
Peak value		±200 max	volts
Average value		100 max	volts
Direct Interelectrode Capacitances (Approx.):	Unit No.1	Unit No.2	
Grid to Plate	1.7	1.7	pF
Grid to Cathode and Heater	1.6	1.6	pF
Plate to Cathode and Heater	0.46	0.34	pF

**Class A<sub>1</sub> Amplifier (Each Unit)**

<b>MAXIMUM RATINGS (Design-Maximum Values)</b>		
Plate Voltage	350	volts
Grid Voltage:		
Negative-bias value	-55	volts
Positive-bias value	0	volts
Plate Dissipation	1.2	watts

**EQUIVALENT-NOISE AND HUM VOLTAGE (References To Grid, Each Unit)\***

Average Value ..... 1.8  $\mu$ V rms

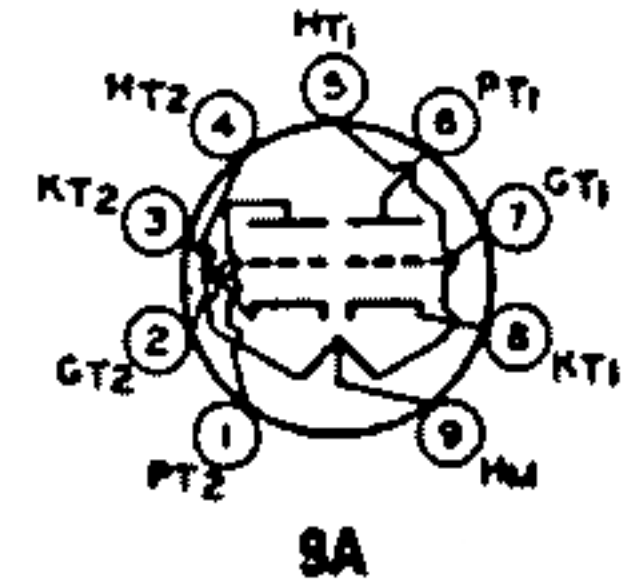
\* Measured in "true rms" units under the following conditions: Heater voltage (parallel connection), 6.3 volts ac; center tap of heater transformer grounded; plate supply voltage, 250 volts dc; plate load resistor, 100000 ohms; cathode resistor, 2700 ohms bypassed by 100- $\mu$ F capacitor; grid resistor, 0 ohms; and amplifier covering frequency range between 25 and 10000 Hz.

**12AY3  
12AY3A**

Refer to type 6AY3B.

**12AY7 MEDIUM-MU TWIN TRIODE**

Miniature type used in the first stages of high-gain audio-frequency amplifiers. Outlines section, 6B; requires miniature 9-contact socket. Each triode unit is independent of the other except for the common heater. Use of the 12.6-volt connection with an ac heater supply is not recommended for applications involving low hum. For typical operation as a resistance-coupled amplifier, refer to Resistance-Coupled Amplifier section.



Heater Arrangement:	Series	Parallel	
Heater Voltage (ac/dc) .....	12.6	6.3	volts
Heater Current .....	0.15	0.8	ampere
Peak Heater-Cathode Voltage .....		$\pm 90$ max	volts
Direct Interelectrode Capacitances (Approx., Each Unit)			
Grid to Plate .....		1.3	pF
Grid to Cathode and Heater .....		1.3	pF
Plate to Cathode and Heater .....		0.6	pF

**Class A<sub>1</sub> Amplifier (Each Unit)**

**MAXIMUM RATINGS (Design-Center Values)**

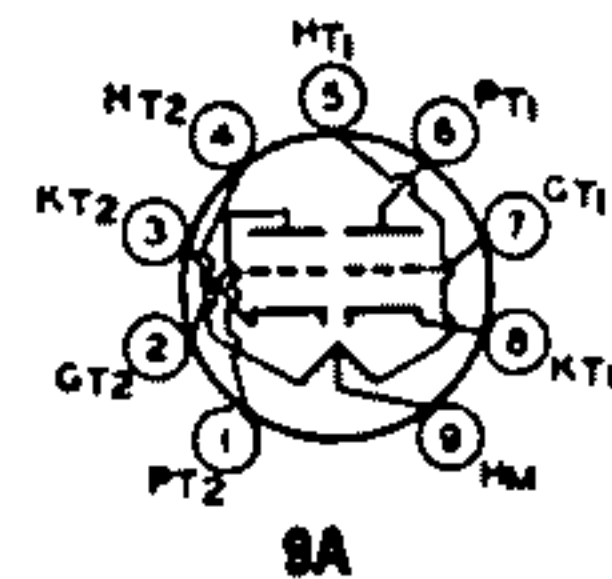
Plate Voltage .....	300	volts
Grid Voltage:		
Negative-bias value .....	-50	volts
Positive-bias value .....	0	volts
Cathode Current .....	10	mA
Plate Dissipation .....	1.5	watts
<b>CHARACTERISTICS</b>		
Plate Voltage .....	250	volts
Grid Voltage .....	-4	volts
Amplification Factor .....	40	
Plate Resistance .....	22800	ohms
Transconductance .....	1750	$\mu$ mhoe
Plate Current .....	8	mA
Grid Voltage (Approx.) for plate current of 10 mA .....	-11	volts

**12AZ7**

Refer to chart at end of section.

**12AZ7A MEDIUM-MU TWIN TRIODE**

Miniature type used in direct-coupled cathode-drive rf amplifier circuits of vhf color and black-and-white television tuners. Outlines section, 6B; requires miniature 9-contact socket. For characteristics as class A<sub>1</sub> amplifier, refer to miniature type 12AT7.



<b>Heater Voltage (ac/dc):</b>		
Series .....	12.6	volts
Parallel .....	6.3	volts
<b>Heater Current:</b>		
Series .....	0.225	ampere
Parallel .....	0.45	ampere
Heater Warm-up Time (Average) .....	11	seconds
<b>Heater-Cathode Voltage:</b>		
Peak value .....	$\pm 200$ max	volts
Average value .....	100 max	volts



Direct Interelectrode Capacitance (Approx.):	Unshielded	Shielded <sup>a</sup>	
Grid to Plate (Each unit)	2	1.9	pF
Grid to Cathode and Heater (Each unit)	2.6	2.8	pF
Plate to Cathode and Heater:			
Unit No.1	0.44	1.4	pF
Unit No.2	0.36	1.6	pF

<sup>a</sup> With external shield connected to cathode of unit under test.

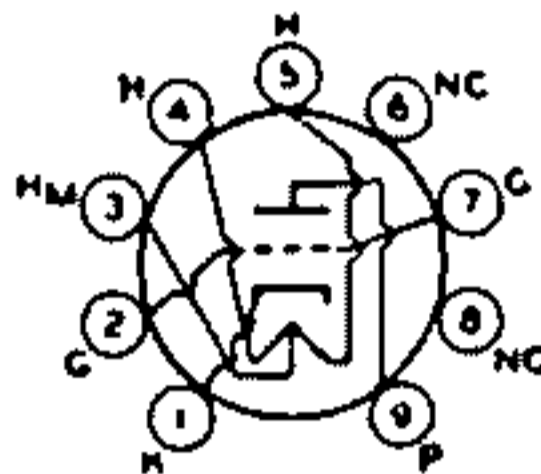
**Class A<sub>1</sub> Amplifier (Each Unit)**

**MAXIMUM RATINGS (Design-Maximum Values)**

Plate Voltage	350	volts
Grid Voltage, Negative-bias value	-55	volts
Plate Dissipation	2.5	watts

**MAXIMUM CIRCUIT VALUES (Each Unit)**

Grid-Circuit Resistance:		
For fixed-bias operation	0.25	megohm
For cathode-bias operation	1	megohm



9AG

**LOW-MU TRIODE**

**12B4A**

Miniature type used as vertical-deflection amplifier in television receivers. Outlines section, 6E; requires miniature 9-contact socket.

Heater Voltage	Series 12.6	Parallel 6.3	volts
Heater Current	0.3	0.6	ampere
Heater Warm-up Time	—	11	seconds
Heater-Cathode Voltage:			
Peak value		±200 max	volts
Average value		100 max	volts
Direct Interelectrode Capacitances:			
Grid to Plate		4.8	pF
Grid to Cathode and Heater		8	pF
Plate to Cathode and Heater		1.5	pF

**Class A<sub>1</sub> Amplifier**

**MAXIMUM RATINGS (Design-Center Values)**

Plate Voltage	550	volts
Grid Voltage, Negative-bias value	-50	volts
Plate Dissipation	5.5	watts

**CHARACTERISTICS**

Plate Voltage	150	volts
Grid Voltage	-17.5	volts
Amplification Factor	6.5	
Plate Resistance (Approx.)	1090	ohms
Transconductance	6300	μmhos
Plate Current	34	mA
Plate Current for grid voltage of -23 volts	9.6	mA
Grid Voltage (Approx.) for plate current of 200 μA	-32	volts

**MAXIMUM CIRCUIT VALUES**

Grid-Circuit Resistance:		
For fixed-bias operation	0.47	megohm
For cathode-bias operation	2.2	megohms

**Vertical-Deflection Amplifier**

For operation in a 525-line, 30-frame system

**MAXIMUM RATINGS (Design-Center Values)**

DC Plate Voltage	550	volts
Peak Positive-Pulse Plate Voltage <sup>‡</sup> (Absolute Maximum)	1000†	volts
Peak Negative-Pulse Grid Voltage	-250	volts
Peak Cathode Current	105	mA
Average Cathode Current	30	mA
Plate Dissipation	5.5	watts

**MAXIMUM CIRCUIT VALUE**

Grid-Circuit Resistance, for cathode-bias operation	2.2	megohms
---	-----	---------

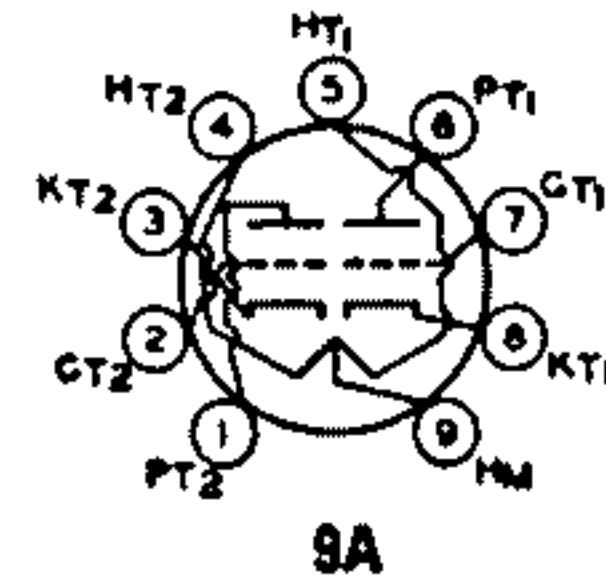
<sup>‡</sup> Pulse duration must not exceed 15% of a vertical scanning cycle (2.5 milliseconds).

† Under no circumstances should this absolute value be exceeded.

<b>12B8GT</b>	Refer to chart at end of section.
<b>12BA6</b>	Refer to type 6BA6.
<b>12BA7</b>	Refer to chart at end of section.
<b>12BD6</b>	Refer to chart at end of section.
<b>12BE3</b>	Refer to type 6BE3.
<b>12BE6</b>	Refer to type 6BE6.
<b>12BF6</b>	Refer to chart at end of section.
<b>12BF11</b>	Refer to type 6BF11.
<b>12BH7</b>	Refer to chart at end of section.

## 12BH7A MEDIUM-MU TWIN TRIODE

Miniature type used as combined vertical-deflection amplifier and vertical oscillator, and as horizontal-deflection oscillator, in television receivers, and in phase-inverter and multivibrator circuits. Outlines section, 6E; requires miniature 9-contact socket. Each triode unit is independent of the other except for the common heater.



Heater Arrangement:	Series	Parallel	
Heater Voltage (ac/dc) .....	12.6	6.3	volts
Heater Current .....	0.3	0.6	ampere
Heater Warm-up Time (Average) .....	—	11	seconds
Heater-Cathode Voltage:			
Peak value .....		±200 max	volts
Average value .....		100 max	volts
Direct Interelectrode Capacitances (Approx.):	Unit No.1	Unit No.2	
Grid to Plate .....	2.6	2.6	pF
Grid to Cathode and Heater .....	3.2	3.2	pF
Plate to Cathode and Heater .....	0.5	0.4	pF
Plate of Unit No.1 to Plate of Unit No.2 .....		0.8	pF

### Class A<sub>1</sub> Amplifier (Each Unit)

MAXIMUM RATINGS (Design-Center Values)		
Plate Voltage .....	300	volts
Grid Voltage:		
Negative-bias value .....	-50	volts
Positive-bias value .....	0	volts
Cathode Current .....	20	mA
Plate Dissipation:		
Each Plate .....	3.5	watts
Both plates (Both units operating) .....	7	watts

### CHARACTERISTICS

Plate Voltage .....	250	volts
Grid Voltage .....	-10.5	volts
Amplification Factor .....	18.6	
Plate Resistance (Approx.) .....	5300	ohms
Transconductance .....	3100	μmhos
Plate Current .....	11.5	mA
Plate Current for grid voltage of -14 volts .....	4	mA
Grid Voltage (Approx.) for plate current of 50 μA .....	-23	volts

### MAXIMUM CIRCUIT VALUES

Grid-Circuit Resistance:		
For fixed-bias operation .....	0.25	megohm
For cathode-bias operation .....	1.0	megohm

### Oscillator (Each Unit)

For operation in a 525-line, 30-frame system

MAXIMUM RATINGS (Design-Center Values)	Vertical-Deflection Oscillator	Horizontal-Deflection Oscillator	
DC Plate Voltage .....	450	450	volts
Peak Negative-Pulse Grid Voltage .....	-400	-600	volts
Peak Cathode Current .....	70	300	mA
Average Cathode Current .....	20	20	mA
Plate Dissipation:			
Each Plate .....	3.5	3.5	watts
Both Plates (Both units operating) .....	7	7	watts

**MAXIMUM CIRCUIT VALUES**

Grid-Circuit Resistance ..... 2.2 2.2 megohms

**Vertical-Deflection Amplifier (Each Unit)**

For operation in a 525-line, 30-frame system

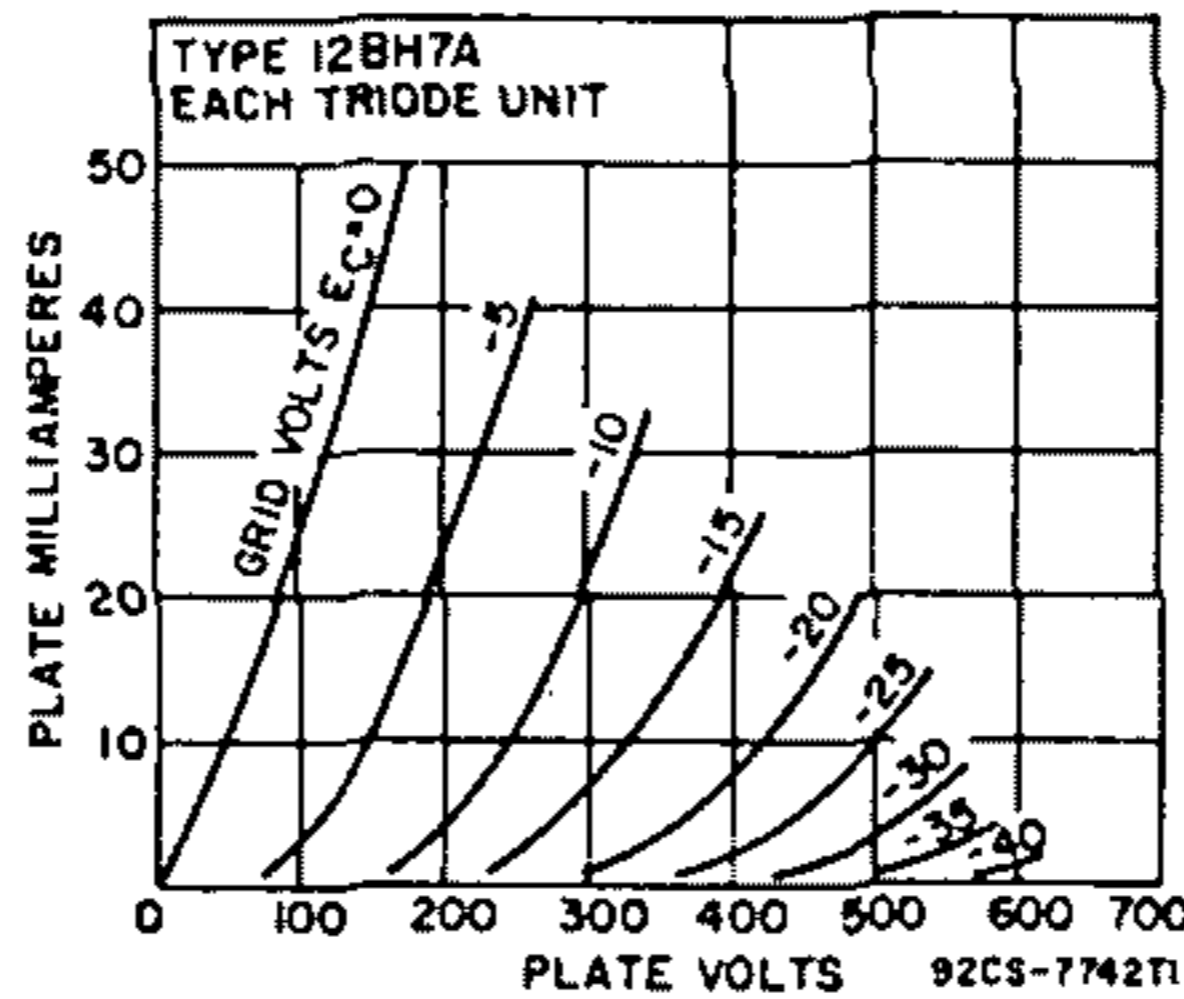
**MAXIMUM RATINGS (Design-Center Values)**

DC Plate Voltage ..... 450 volts  
 Peak Positive-Pulse Plate Voltage\* (Absolute maximum) ..... 1500\* volts  
 Peak Negative-Pulse Grid Voltage ..... -250 volts  
 Peak Cathode Current ..... 70 mA  
 Average Cathode Current ..... 20 mA  
 Plate Dissipation:  
   Each Plate ..... 3.5 watts  
   Both Plates (Both units operating) ..... 7 watts

**MAXIMUM CIRCUIT VALUE**

Grid-Circuit Resistance for cathode-bias operation ..... 2.2 megohms

\* Pulse duration must not exceed 15% of a vertical scanning cycle (2.5 milliseconds).  
 \* Under no circumstances should this absolute value be exceeded.



Refer to chart at end of section.

**12BK5**

Refer to chart at end of section.

**12BL6**

Refer to type 6BN6.

**12BN6**

Refer to type 6BQ6GTB/6CU6.

**12BQ6GTB/12CU6**

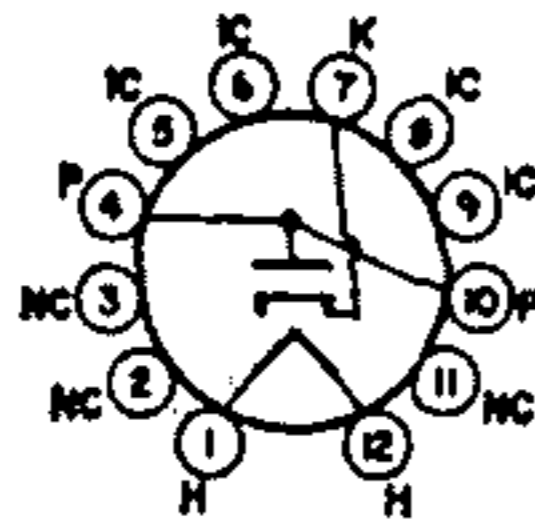
Refer to chart at end of section.

**12BR7**

Refer to type 6BS3A.

**12BS3**

**12BS3A**



**HALF-WAVE  
VACUUM RECTIFIER**

**12BT3**

Duodecar type used as damper tube in horizontal-deflection circuits of television receivers. Outlines section, 8C; requires duodecar 12-contact socket. Heater: volts (ac/dc), 12.6; amperes, 0.45.

**Damper Service**

For operation in a 525-line, 30-frame system

**MAXIMUM RATINGS (Design-Maximum Values)**

Peak Inverse Plate Voltage\* ..... 3300 volts  
 Peak Plate Current ..... 1000 mA  
 Average Plate Current ..... 165 mA  
 Plate Dissipation ..... 5.5 watts

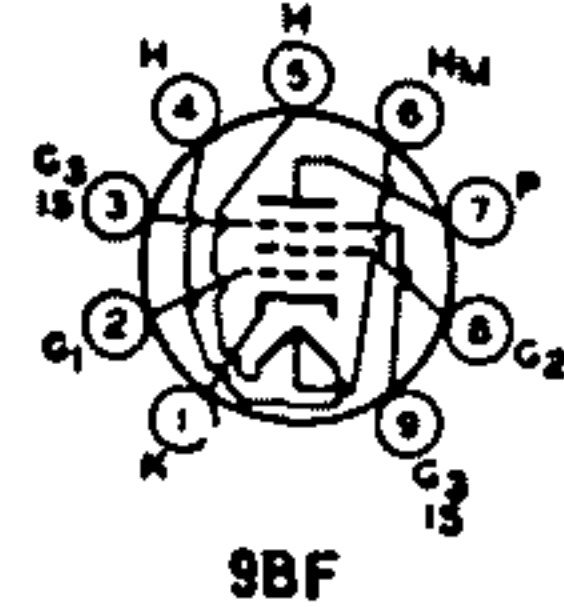


<b>Heater-Cathode Voltage:</b>			
Peak value .....	+800	-3300	volts
Average value .....	+100	-600	volts

**CHARACTERISTICS, Instantaneous Value**  
 Tube Voltage Drop for plate current of 250 mA max ..... 21 volts  
 # Pulse duration must not exceed 15% of a horizontal scanning cycle (10 microseconds).

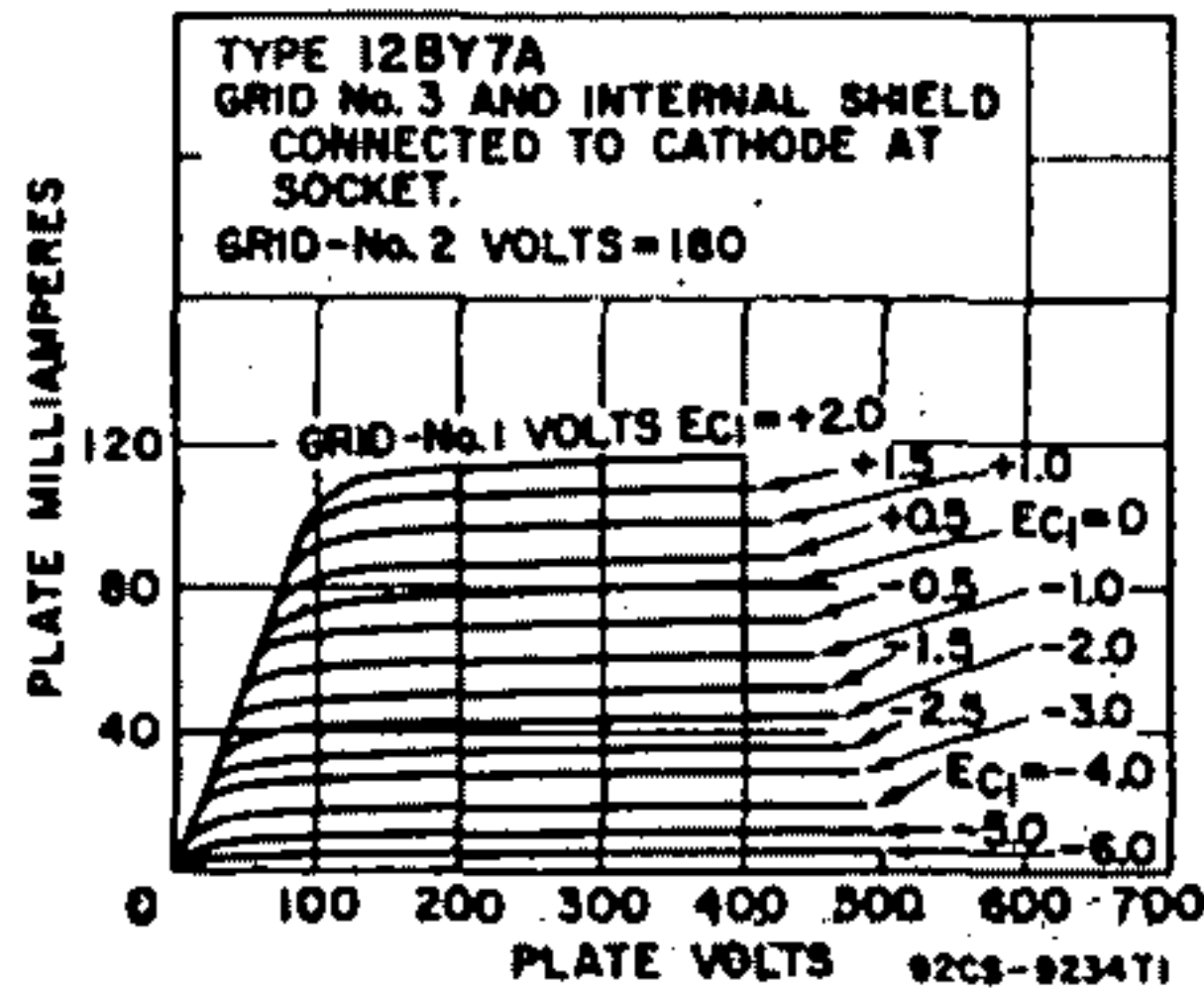
- 12BV7** Refer to chart at end of section.
- 12BW4** Refer to chart at end of section.
- 12BY7** Refer to chart at end of section.

## 12BY7A SHARP-CUTOFF PENTODE



Miniature type used as video amplifier in television receivers. Outlines section, 6E; require miniature 9-contact socket.

<b>Heater Arrangement:</b>	<b>Series</b>	<b>Parallel</b>	
Heater Voltage (ac/dc) .....	12.6	6.3	volts
Heater Current .....	0.8	0.6	ampere
Heater Warm-up Time (Average) .....	—	11	seconds
<b>Heater-Cathode Voltage:</b>			
Peak value .....		±200 max	volts
Average value .....		100 max	volts
<b>Direct Interelectrode Capacitances:</b>			
Grid No.1 to Plate .....		0.063	pF
Grid No.1 to Cathode, Heater, Grid No.2, Grid No.3, and Internal Shield .....		10.2	pF
Plate to Cathode, Heater, Grid No.2, and Internal Shield .....		8.5	pF
<b>MAXIMUM RATINGS (Design-Maximum Values)</b>			
Plate Supply Voltage .....		230	volts
Grid-No.3 (Suppressor-Grid) Voltage, Positive value .....		0	volts
Grid-No.2 (Screen-Grid) Voltage .....		190	volts
Grid-No.1 (Control-Grid) Voltage .....			
Negative-bias value .....		-55	volts
Positive-bias value .....		0	volts
Plate Dissipation .....		6.5	watts
Grid-No.2 Input .....		1.2	watts
<b>CHARACTERISTICS</b>			
Plate Supply Voltage .....		250	volts
Grid No.3 .....	Connected to cathode at socket		
Grid-No.2 Supply Voltage .....		180	volts
Cathode-Bias Resistor .....		100	ohms
Plate Resistance (Approx.) .....		93000	ohms
Transconductance .....		11000	μmhos
Plate Current .....		26	mA
Grid-No.2 Current .....		5.75	mA
Grid-No.1 Voltage (Approx.) for plate current of 20 μA .....		-11.6	volts

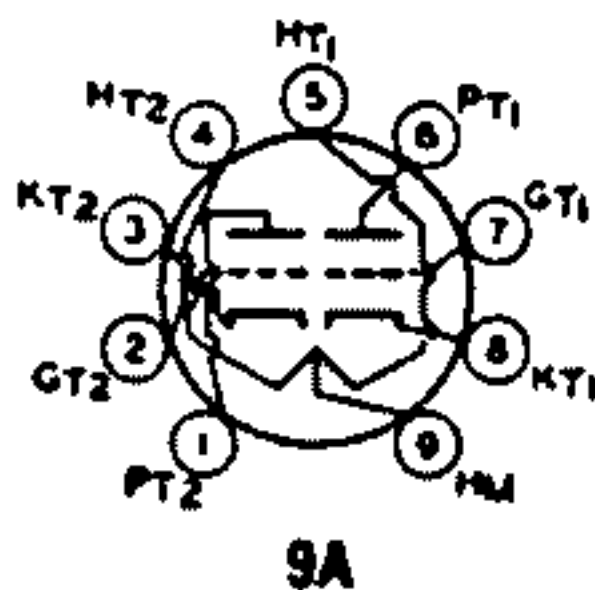


**MAXIMUM CIRCUIT VALUES**

Grid-No.1-Circuit Resistance:		
For fixed-bias operation .....	0.25	megohm
For cathode-bias operation .....	1	megohm

Refer to type 6BZ6.

**12BZ6**



9A

**HIGH-MU TWIN TRIODE**

**12BZ7**

Miniature type used in sync-separator and sync-amplifier circuits of television receivers, and in clipping circuits and audio-amplifier applications. Outlines section, 6E; requires miniature 9-contact socket.

	Series	Parallel	
Heater Voltage .....	12.6	6.3	volts
Heater Current .....	0.3	0.6	ampere
Peak Heater-Cathode Voltage .....		±180 max	volts
Direct Interelectrode Capacitances:	Unit No.1	Unit No.2	
Grid to Plate .....	2.5	2.5	pF
Grid to Cathode, and Heater .....	6.5	6.5	pF
Plate to Cathode, and Heater .....	0.7	0.55	pF
Plate of Unit No.1 to Plate of Unit No.2 .....		1.3	pF

**Class A<sub>1</sub> Amplifier (Each Unit)**

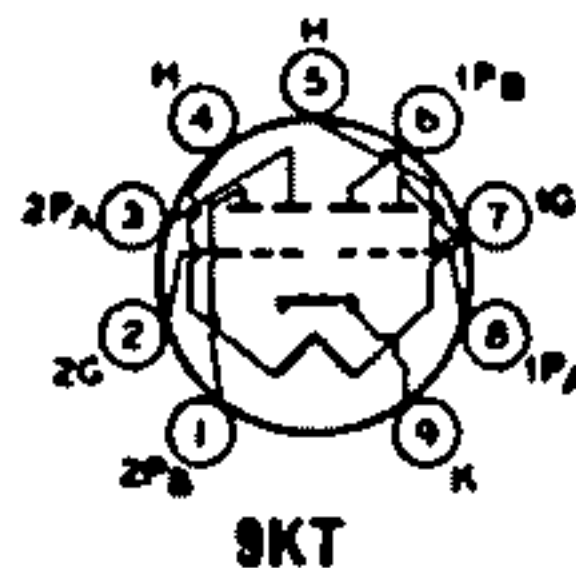
<b>MAXIMUM RATINGS (Design-Center Values)</b>		
Plate Voltage .....	300	volts
Grid Voltage:		
Negative-bias value .....	-50	volts
Positive-bias value .....	0	volts
Plate Dissipation .....	1.5	watts
<b>CHARACTERISTICS</b>		
Plate Voltage .....	250	volts
Grid Voltage .....	-2	volts
Amplification Factor .....	100	
Plate Resistance (Approx.) .....	81800	ohms
Transconductance .....	3200	µmhos
Plate Current .....	2.5	mA
<b>MAXIMUM CIRCUIT VALUE</b>		
Grid-Circuit Resistance for contact-potential-bias operation .....	5	megohms

- Refer to type 6CU5. **12C5**
- Refer to chart at end of section. **12C8**
- Refer to type 6CA5. **12CA5**
- Refer to type 6CK3. **12CK3**
- Refer to type 6CL3. **12CL3**
- Refer to chart at end of section. **12CN5**
- Refer to type 6CR6. **12CR6**
- Refer to chart at end of section. **12CT8**
- Refer to type 6CU5. **12CU5/12C5**
- Refer to type 6BQ6GTB/6CU6. **12CU6**
- Refer to chart at end of section. **12CX6**
- Refer to type 6DA4. **12D4**
- Refer to type 6DB5. **12DB5**
- Refer to chart at end of section. **12DE8**
- Refer to type 6DK6. **12DK6**
- Refer to chart at end of section. **12DK7**
- Refer to chart at end of section. **12DL8**

12DM4	Refer to chart at end of section.
12DM4A	Refer to chart at end of section.
12DQ6A	Refer to chart at end of section.
12DQ6B	Refer to type 6DQ6B.
12DQ7	Refer to chart at end of section.
12DS7	Refer to chart at end of section.
12DS7A	Refer to chart at end of section.
12DT5	Refer to type 6DT5.
12DT8	Refer to type 6DT8.
12DU7	Refer to chart at end of section.
12DV8	Refer to chart at end of section.
12DW7	Refer to chart at end of section.
12DY8	Refer to chart at end of section.
12DZ6	Refer to chart at end of section.
12EA6	Refer to chart at end of section.
12EC8	Refer to chart at end of section.
12ED5	Refer to chart at end of section.
12EG6	Refer to chart at end of section.
12EH5	Refer to type 6EH5.
12EK6	Refer to chart at end of section.
12EL6	Refer to chart at end of section.
12EM6	Refer to chart at end of section.
12EN6	Refer to chart at end of section.
12EQ7	Refer to type 6EQ7.
12F5GT	Refer to chart at end of section.
12F8	Refer to chart at end of section.
12FK6	Refer to chart at end of section.
12FM6	Refer to chart at end of section.

**12FQ8****HIGH-MU  
TWIN DOUBLE-PLATE TRIODE**

Miniature type used in frequency-divider and complex-wave-generator circuits of electronic musical instruments. Outlines section, 8B; requires miniature 9-contact socket.



Heater Voltage (ac/dc) .....	12.6	volts
Heater Current .....	0.15	ampere
Heater-Cathode Voltage:		
Peak value .....	±200 max	volts
Average value .....	100 max	volts
Direct Interelectrode Capacitances (Approx.):		
Grid to Either Plate (Each Unit) .....	0.9	pF
Grid to Cathode, and Heater (Each Unit) .....	1.8	pF
Plate A of Unit No.1 to Cathode, and Heater .....	0.24	pF



Plate B of Unit No.1 to Cathode, and Heater .....	0.24	pF
Plate A of Unit No.2 to Cathode, and Heater .....	0.2	pF
Plate B of Unit No.2 to Cathode, and Heater .....	0.18	pF
Plate A to Plate B (Each Unit) .....	0.7	pF
Plate A of Unit No.1 to Plate A of Unit No.2 .....	0.4	pF

**Class A<sub>1</sub> Amplifier (Each Unit)**

**CHARACTERISTICS\***

Plate Voltage .....	250	volts
Grid Voltage .....	-1.5	volts
Amplification Factor .....	95	
Plate Resistance (Approx.) .....	76000	ohms
Transconductance .....	1250	μmhos
Plate Current .....	1.5	mA

\* Using either plate A or plate B, with plate not in use connected to ground.

**Frequency-Divider and Complex-Wave Generator (Each Unit)**

**MAXIMUM RATINGS (Design-Maximum Values)**

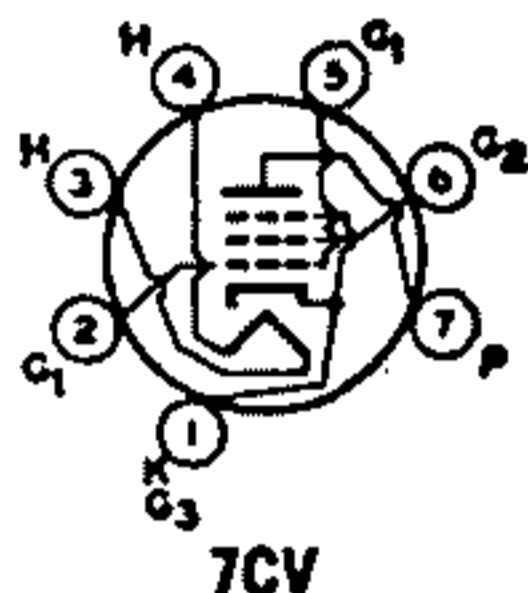
Plate A Voltage .....	330	volts
Plate B Voltage .....	330	volts
Grid Voltage, Positive-bias value .....	0	volts
Plate A Dissipation .....	0.5	watt
Plate B Dissipation .....	0.5	watt

Refer to chart at end of section.

**12FR8**

Refer to chart at end of section.

**12FV7**



**7CV**

**POWER PENTODE**

**12FX5**

Miniature type used in output stages of audio amplifiers. Outlines section, 5D; requires miniature 7-contact socket. Type 60FX5 is identical with type 12FX5 except for heater ratings.

	<b>12FX5</b>	<b>60FX5</b>	
Heater Voltage (ac/dc) .....	12.6	60	volts
Heater Current .....	0.45	0.1	ampere
Heater Warm-up Time (Average) .....	11	—	seconds
Heater-Cathode Voltage:			
Peak value .....	±200 max	±200 max	volts
Average value .....	100 max	100 max	volts
Direct Interelectrode Capacitances (Approx.):			
Grid No.1 to Plate .....		0.65	pF
Grid No.1 to Cathode, Heater, Grid No.2, and Grid No.3 .....		17	pF
Plate to Cathode, Heater, Grid No.2, and Grid No.3 .....		9	pF

**Class A<sub>1</sub> Amplifier**

**MAXIMUM RATINGS (Design-Maximum Values)**

Plate Voltage .....	150	volts
Grid-No.2 (Screen-Grid) Voltage .....	130	volts
Plate Dissipation .....	5.5	watts
Grid-No.2 Input .....	2	watts
Bulb Temperature (At hottest point) .....	225	°C

**TYPICAL OPERATION**

Plate Supply Voltage .....	110	volts
Grid-No.2 Supply Voltage .....	115	volts
Cathode-Bias Resistor .....	62	ohms
Peak AF Grid-No.1 Voltage .....	3	volts
Zero-Signal Plate Current .....	36	mA
Maximum-Signal Plate Current .....	35	mA
Zero-Signal Grid No.2 Current .....	10	mA
Maximum-Signal Grid No.2 Current .....	12	mA
Plate Resistance .....	17500	ohms
Transconductance .....	13500	μmhos
Load Resistance .....	3000	ohms
Total Harmonic Distortion .....	8	per cent
Maximum-Signal Power Output .....	1.3	watts

**MAXIMUM CIRCUIT VALUES**

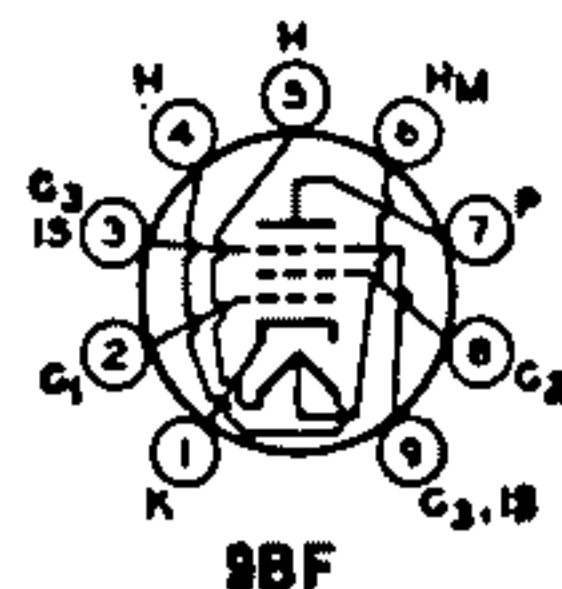
Grid-No.1-Circuit Resistance:		
For fixed-bias operation .....	0.1	megohm
For cathode-bias operation .....	0.5	megohm

<b>12FX8</b>	Refer to chart at end of section.
<b>12FX8A</b>	
<b>12GA6</b>	Refer to chart at end of section.
<b>12GC6</b>	Refer to chart at end of section.
<b>12GE5</b>	Refer to type 6GE5.
<b>12GJ5</b>	Refer to chart at end of section.
<b>12GJ5A</b>	Refer to type 6GJ5A.

## 12GN7 SHARP-CUTOFF PENTODE

### 12GN7A

Miniature types with frame grid used as video-amplifier tubes in color and black-and-white television receivers. Outlines section, 6E; require miniature 9-contact socket. Type 12GN7A is identical with type 12GN7 except for a higher plate dissipation. Heater: volts, 6.3 (parallel), 12.6 (series); amperes, 0.6 (parallel), 0.3 (series); warm-up time (average), 11 seconds, maximum heater-cathode volts,  $\pm 200$  peak, 100 average.



#### Class A, Amplifier

##### MAXIMUM RATINGS (Design-Maximum Values)

Plate Voltage	400	volts
Grid-No.2 (Screen-Grid) Supply Voltage	330	volts
Grid-No.2 Voltage	See curve page 96	
Grid-No.1 (Control-Grid) Voltage, Positive-bias value	0	volts
Plate Dissipation (12GN7)	7.5	watts
Plate Dissipation (12GN7A)	11.5	watts
Grid-No.2 Input:		
For grid-No.2 voltages up to 165 volts	1.5	watts
For grid-No.2 voltages between 165 and 330 volts	See curve page 96	

##### CHARACTERISTICS

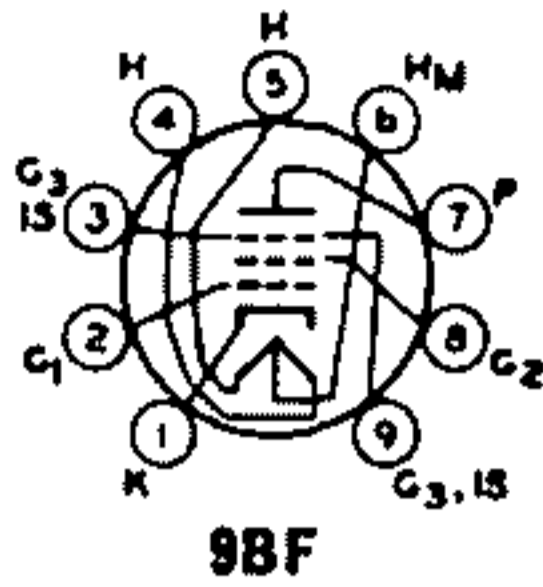
Plate Supply Voltage	50	250	volts
Grid-No.2 Supply Voltage	125	150	volts
Grid-No.1 Voltage	0	0	volts
Cathode-Bias Resistor	—	58	ohms
Plate Resistance (Approx.)	—	0.05	megohm
Transconductance	—	36000	$\mu$ mbos
Plate Current	70*	28	mA
Grid-No.2 Current	24*	6.5	mA
Grid-No.1 Voltage (Approx.) for plate current of 100 $\mu$ A	—	-5.7	volts

##### MAXIMUM CIRCUIT VALUE

Grid-No.1-Circuit Resistance	0.25	megohm
------------------------------	------	--------

\* This value can be measured by a method involving a recurrent waveform such that the maximum ratings of the tube will not be exceeded.

<b>12GT5</b>	Refer to type 6GT5A.
<b>12GT5A</b>	Refer to chart at end of section.
<b>12GW6</b>	Refer to chart at end of section.
<b>12GW6/12DQ6B</b>	Refer to type 6GW6/6DQ6B.
<b>12H6</b>	Refer to chart at end of section.
<b>12HE7</b>	Refer to type 38HE7.



**SHARP-CUTOFF PENTODE**

**12HG7**

Neonovial type with frame grid used as video amplifier in color and black-and-white television receivers. Outlines section, 10C; requires 9-contact neonovial socket.

<b>Heater Arrangement:</b>			
Heater Voltage (ac/dc) .....	Series	Parallel	
Heater Current .....	12.6	6.8	volts
	0.26	0.62	ampere
<b>Heater-Cathode Voltage:</b>			
Peak value .....		±200 max	volts
Average value .....		100 max	volts
<b>Direct Interelectrode Capacitances:</b>			
Grid No.1 to Plate .....		0.15 max	pF
Grid No.1 to Cathode, Heater, Grid No.2, Grid No.3, and Internal Shield .....		14 max	pF
Plate to Cathode, Heater, Grid No.2, Grid No.3, and Internal Shield .....		4.4 max	pF

**Class A<sub>1</sub> Amplifier**

**MAXIMUM RATINGS (Design-Maximum Values)**

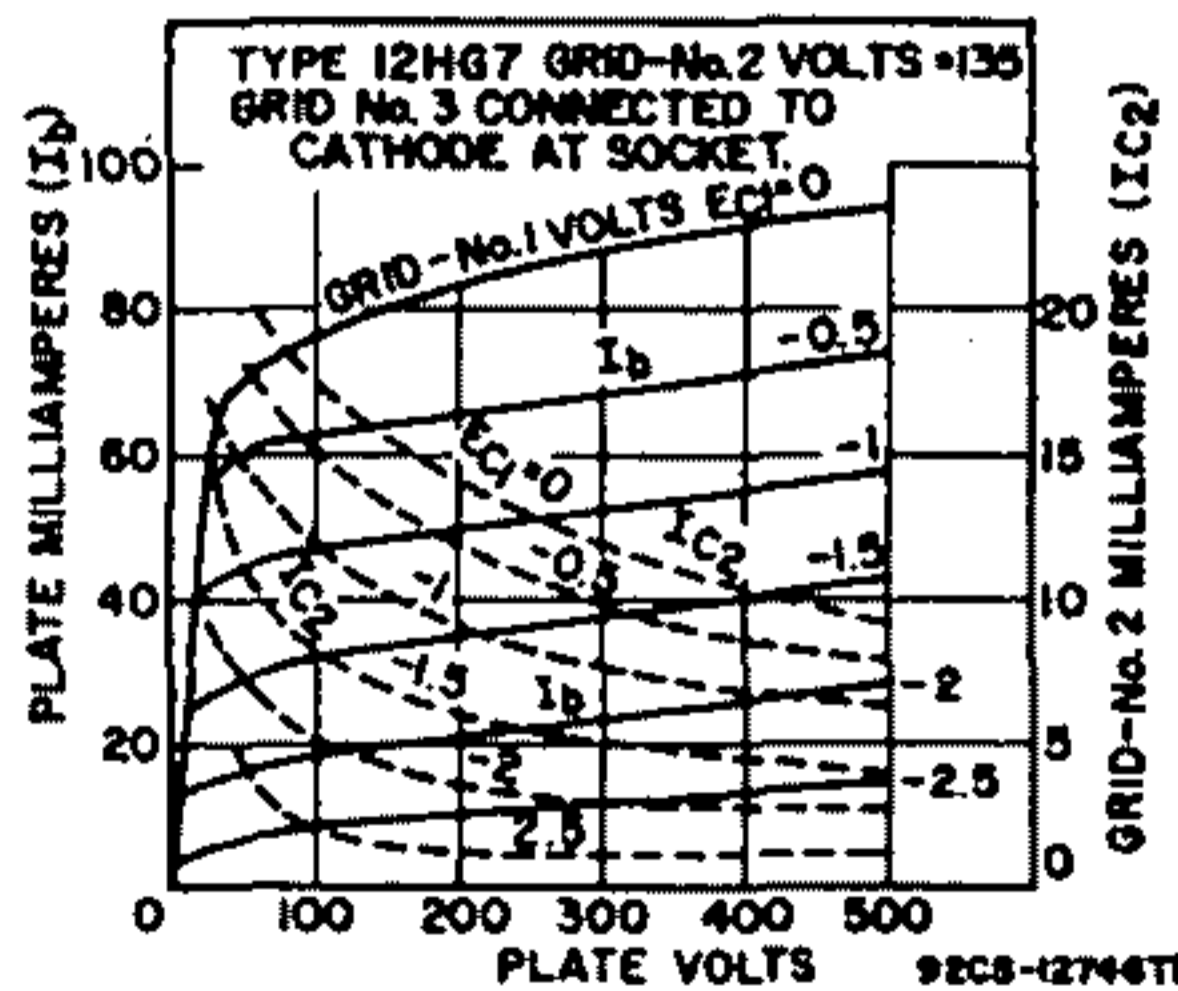
Plate Voltage .....	400	volts
Grid-No.2 (Screen-Grid) Supply Voltage .....	330	volts
Grid-No.2 Voltage .....	See curve page 96	
Grid-No.1 (Control-Grid) Voltage, Positive-bias value .....	0	volts
Plate Dissipation .....	10	watts
Grid-No.2 Input:		
For Grid-No.2 voltages up to 165 volts .....	1	watt
For Grid-No.2 voltages between 165 and 330 volts .....	See curve page 96	

**CHARACTERISTICS**

Plate Supply Voltage .....	300	volts
Grid No.3 (Suppressor Grid) .....	Connected to cathode at socket	
Grid-No.2 Supply Voltage .....	135	volts
Grid No.1 .....	Connected to negative end of cathode resistor	
Cathode Resistor .....	47	ohms
Plate Resistance (Approx.) .....	60000	ohms
Transconductance .....	32000	μmhos
Plate Current .....	31	mA
Grid-No.2 Current .....	4.8	mA
Grid-No.1 Voltage (Approx.) for plate current of 100 μA .....	-4.5	volts

**MAXIMUM CIRCUIT VALUES**

<b>Grid-No.1-Circuit Resistance:</b>		
For fixed-bias operation .....	0.1	megohm
For cathode-bias operation .....	0.25	megohm



Refer to chart at end of section.  
 Refer to chart at end of section.  
 Refer to chart at end of section.

**12J5GT**  
**12J7GT**  
**12J8**

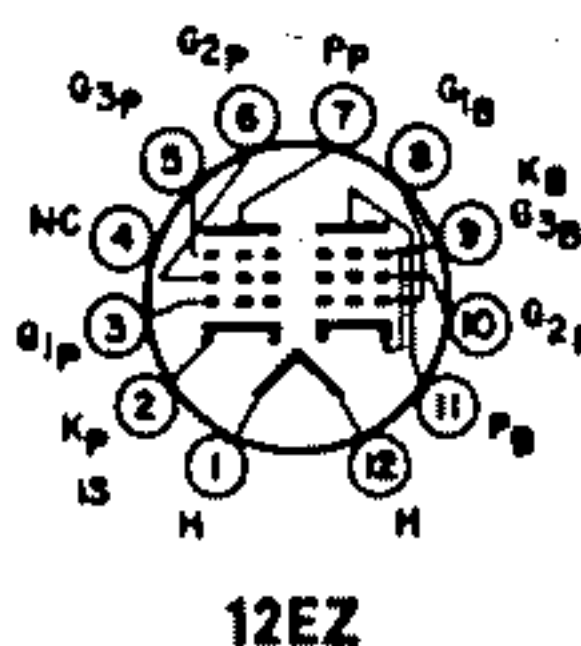


12JB6	Refer to type 6JB6A.
12JB6A	
12JN6	Refer to type 6JN6.
12JN8	Refer to type 6JN8.
12JT6	
12JT6A	Refer to type 6JT6A.
12K5	Refer to chart at end of section.
12K7GT	Refer to chart at end of section.
12K8	Refer to chart at end of section.
12KL8	Refer to chart at end of section.
12L6GT	Refer to chart at end of section.
12Q7GT	Refer to chart at end of section.
12R5	Refer to chart at end of section.
12S8GT	Refer to chart at end of section.
12SA7	
12SA7GT	Refer to chart at end of section.
12SC7	Refer to chart at end of section.
12SF5	
12SF5GT	Refer to chart at end of section.
12SF7	Refer to chart at end of section.
12SG7	Refer to chart at end of section.
12SH7	Refer to chart at end of section.
12SJ7	
12SJ7GT	Refer to chart at end of section.
12SK7	
12SK7GT	Refer to chart at end of section.
12SL7GT	Refer to type 6SL7GT.
12SN7GT	Refer to chart at end of section.
12SN7GTA	Refer to type 6SN7GTB.
12SQ7	
12SQ7GT	Refer to chart at end of section.
12SR7	
12SR7GT	Refer to chart at end of section.
12U7	Refer to chart at end of section.
12V6GT	Refer to type 6V6.
12W6GT	Refer to type 6W6GT.
12X4	Refer to type 6X4.
12Z3	Refer to chart at end of section.
13CW4	Refer to type 6CW4.

Refer to type 6DE7.	<b>13DE7</b>
Refer to type 6DR7.	<b>13DR7</b>
Refer to type 6EM7.	<b>13EM7</b>
Refer to type 6FD7.	<b>13FD7</b>
Refer to type 6FM7.	<b>13FM7</b>
Refer to type 6GB5.	<b>13GB5</b>
Refer to type 6GF7A.	<b>13GF7</b> <b>13GF7A</b>
Refer to type 6J10.	<b>13J10</b>

**BEAM POWER TUBE—  
SHARP-CUTOFF PENTODE**

**13V10**



Duodecar type used as combined FM detector and audio-frequency output amplifier in television receivers. The beam power unit is used in af output stages and the pentode unit as an FM detector. Outlines section, 8C; requires duodecar 12-contact socket. Heater: volts (ac/dc), 13.2; amperes, 0.45; average warm-up time, 11 seconds; maximum heater-cathode volts,  $\pm 200$  peak, 100 average.

**Beam Power Unit as Class A<sub>1</sub> Amplifier**

<b>MAXIMUM RATINGS (Design-Maximum Values)</b>		
Plate Voltage .....	165	volts
Grid-No.2 (Screen-Grid) Voltage .....	150	volts
Cathode Current .....	65	mA
Plate Dissipation .....	6.5	watts
Grid-No.2 Input .....	1.8	watts
<b>TYPICAL OPERATION</b>		
Plate Voltage .....	145	volts
Grid-No.2 Voltage .....	125	volts
Grid-No.1 (Control-Grid) Voltage .....	-6	volts
Peak AF Grid-No.1 Voltage .....	6	volts
Zero-Signal Plate Current .....	34	mA
Maximum-Signal Plate Current .....	36	mA
Zero-Signal Grid-No.2 Current .....	2.2	mA
Maximum-Signal Grid-No.2 Current .....	5.5	mA
Plate Resistance (Approx.) .....	0.058	megohm
Transconductance .....	6400	$\mu$ mhos
Load Resistance .....	3000	ohms
Total Harmonic Distortion (Approx.) .....	7	per cent
Maximum-Signal Power Output .....	1.5	watts
<b>MAXIMUM CIRCUIT VALUES:</b>		
Grid-No.1-Circuit Resistance:		
For fixed-bias operation .....	0.25	megohm
For cathode-bias operation .....	0.5	megohm

**Pentode Unit as Class A<sub>1</sub> Amplifier**

<b>CHARACTERISTICS</b>		
Plate Supply Voltage .....	160	volts
Grid-No.3 (Suppressor-Grid) Voltage .....	0	volts
Grid-No.2 (Screen-Grid) Supply Voltage .....	100	volts
Cathode-Bias Resistor .....	560	ohms
Plate Resistance (Approx.) .....	0.15	megohm
Transconductance, Grid No.1 to Plate .....	1000	$\mu$ mhos
Transconductance, Grid No.3 to Plate .....	400	$\mu$ mhos
Plate Current .....	1.3	mA
Grid-No.2 Current .....	2	mA
Grid-No.1 Voltage (Approx.) for plate current of 10 $\mu$ A .....	-4.5	volts
Grid-No.3 Voltage (Approx.) for plate current of 10 $\mu$ A .....	-4.5	volts

**Pentode Unit as FM Detector**

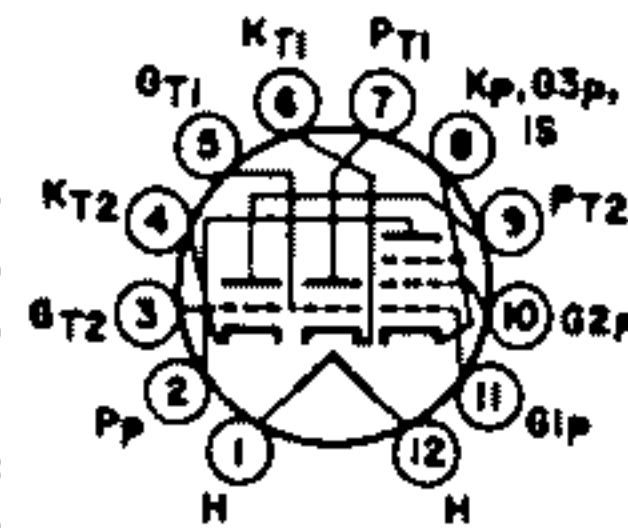
<b>MAXIMUM RATINGS (Design-Maximum Values)</b>		
Plate Voltage .....	330	volts
Grid-No.3 Voltage .....	28	volts
Grid-No.2 Supply Voltage .....	330	volts

Grid-No.2 Voltage .....	See curve page 96
Grid-No.1 (Control-Grid) Voltage, Positive-bias value .....	0 volts
Plate Dissipation .....	1.7 watts
Grid-No.2 Input:	
For grid-No.2 voltages up to 165 volts .....	1.1 watts
For grid-No.2 voltages between 165 and 330 volts .....	See curve page 96

- 14A4** Refer to chart at end of section.
- 14A5** Refer to chart at end of section.
- 14A7** Refer to chart at end of section.
- 14AF7** Refer to chart at end of section.
- 14B6** Refer to chart at end of section.
- 14B8** Refer to chart at end of section.

### 14BL11 DUAL TRIODE—SHARP-CUTOFF PENTODE

Duodecar type used in television receiver applications. The pentode unit is used for video amplifier service, and the triode units for general-purpose use. Outlines section, 8B; requires duodecar 12-contact socket. Heater: volts (ac/dc), 14.2; amperes, 0.45; average warm-up time 11 seconds; maximum heater-cathode volts,  $\pm 200$  peak, 100 average.



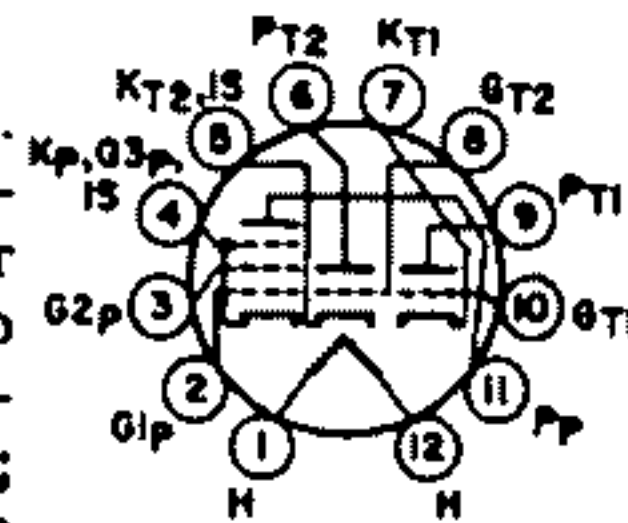
12GC

#### Class A<sub>1</sub> Amplifier

MAXIMUM RATINGS (Design-Maximum Values)	Triode Unit No.1	Triode Unit No.2	Pentode Unit		
Plate Voltage .....	330	330	250		volts
Grid-No.2 (Screen-Grid) Voltage .....	—	—	125		volts
Grid-No.1 (Control-Grid) Voltage, Positive-bias value .....	0	0	0		volts
Plate Dissipation .....	1.5	2.0	2.5		watts
Grid-No.2 Input .....	—	—	1.25		watts
<b>CHARACTERISTICS</b>					
Plate Voltage .....	200	200	35	200	volts
Grid-No.2 Voltage .....	—	—	100	100	volts
Grid-No.1 Voltage .....	—	—	0	—	volts
Cathode-Bias Resistor .....	470	270	—	82	ohms
Amplification Factor .....	40	69	—	—	
Plate Resistance (Approx.) .....	7600	12500	—	70000	ohms
Transconductance .....	5300	5500	—	19000	$\mu$ mhos
Plate Current .....	7.2	7.1	40	16	mA
Grid-No.2 Current .....	—	—	13	3.0	mA
Grid-No.1 Voltage (Approx.) for plate current of 100 $\mu$ A .....	-8	-5.5	—	-5.5	volts
<b>MAXIMUM CIRCUIT VALUES</b>					
Grid-No.1-Circuit Resistance:					
For fixed-bias operation .....	0.5	0.5	0.1		megohms
For cathode-bias operation .....	1.0	1.0	0.25		megohms
	0	0	—		volts

### 14BR11 DUAL TRIODE—SHARP-CUTOFF PENTODE

Duodecar type used in television receiver applications. The high-mu triode unit No. 1 is used for general-purpose use, the medium-mu triode unit No. 2 for sync separator service, and the pentode unit for video amplifier service. Outlines section, 8C; requires duodecar 12-contact socket. Heater: volts (ac/dc), 14.2; amperes, 0.45; warm-up time, 11 seconds; maximum heater-cathode volts,  $\pm 200$  peak, 100 average.



12GL



**Class A<sub>1</sub> Amplifier**

**MAXIMUM RATINGS (Design-Maximum Values)**

	Triode Unit No.1	Triode Unit No.2	Pentode Unit	
Plate Voltage .....	330	330	330	volts
Grid-No.2 (Screen-Grid) Supply Voltage .....	—	—	330	volts
Grid-No.2 Voltage .....	—	—	See curve page 96	
Grid-No.1 (Control-Grid) Voltage, Positive-bias value .....	0	0	0	volts
Plate Dissipation .....	1.5	2.0	4.0	watts
Grid-No.2 Input:				
For grid-No.2 voltages up to 165 volts .....	—	—	1.1	watts
For grid-No.2 voltages between 165 and 330 volts .....			See curve page 96	

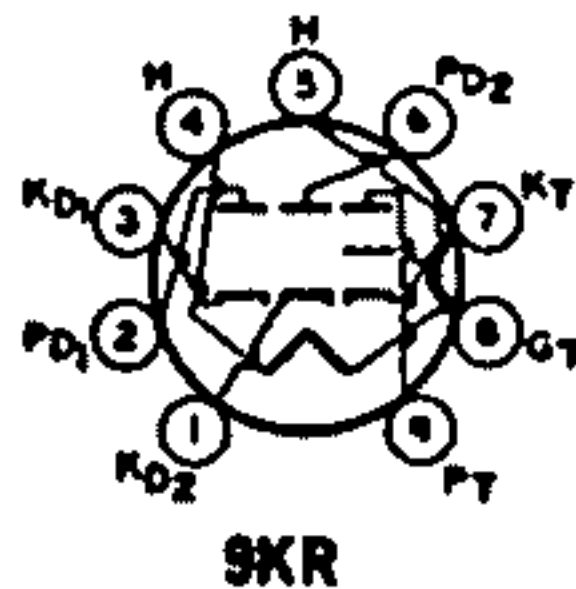
**CHARACTERISTICS**

Plate Voltage .....	200	200	35	135	volts
Grid-No.2 Voltage .....	—	—	135	135	volts
Grid-No.1 Voltage .....	—2	—	0	—	volts
Cathode-Bias Resistor .....	—	220	—	100	ohms
Amplification Factor .....	68	41	—	—	
Plate-Resistance (Approx.) .....	12400	9400	—	45000	ohms
Transconductance .....	5500	4400	—	10400	μmhos
Plate Current .....	7.0	9.2	34	17	mA
Grid-No.2 Current .....	—	—	13	4.0	mA
Grid-No.1 Voltage (Approx.) for plate current of 100 μA .....	—5.5	—6.5	—	—6	volts

**MAXIMUM CIRCUIT VALUES**

Grid-No.1-Circuit Resistance:					
For fixed-bias operation .....	0.5	0.5	1.0		megohm
For cathode-bias operation .....	1.0	1.0	1.0		megohm

- Refer to chart at end of section. **14C5**
- Refer to chart at end of section. **14C7**
- Refer to chart at end of section. **14E6**
- Refer to chart at end of section. **14E7**
- Refer to chart at end of section. **14F7**
- Refer to chart at end of section. **14F8**



**TWIN DIODE—  
HIGH-MU TRIODE**

**14GT8**

Miniature type used as combined detector and af voltage amplifier in radio receivers. Outlines section, 6B; requires miniature 9-contact socket.

Heater Voltage (ac/dc) .....	14	volts
Heater Current .....	0.15	ampere
Heater-Cathode Voltage:		
Peak value .....	±200 max	volts
Average value .....	100 max	volts
Direct Interelectrode Capacitances:		
Triode Unit:		
Grid to Plate .....	1.8	pF
Grid to Cathode and Heater .....	1.6	pF
Plate to Cathode and Heater .....	0.24	pF
Diode Units:		
Diode No.1 Plate to Triode Grid .....	0.09 max	pF
Diode No.2 Plate to Triode Grid .....	0.07 max	pF
Either Diode Cathode to All Other Tube Electrodes .....	6.5	pF
Diode Plate to Cathode and Heater (Each Unit) .....	2.4	pF

**Triode Unit as Class A<sub>1</sub> Amplifier**

**MAXIMUM RATINGS (Design-Maximum Values)**

Plate Voltage .....	330	volts
Grid Voltage, Positive-bias value .....	0	volts
Plate Dissipation .....	1.1	watts

**CHARACTERISTICS, Instantaneous Value**

Plate Voltage .....	250	volts
Grid Voltage .....	-3	volts
Amplification Factor .....	72	
Plate Resistance (Approx.) .....	72000	ohms
Transconductance .....	1000	$\mu$ mbos
Plate Current .....	0.7	mA

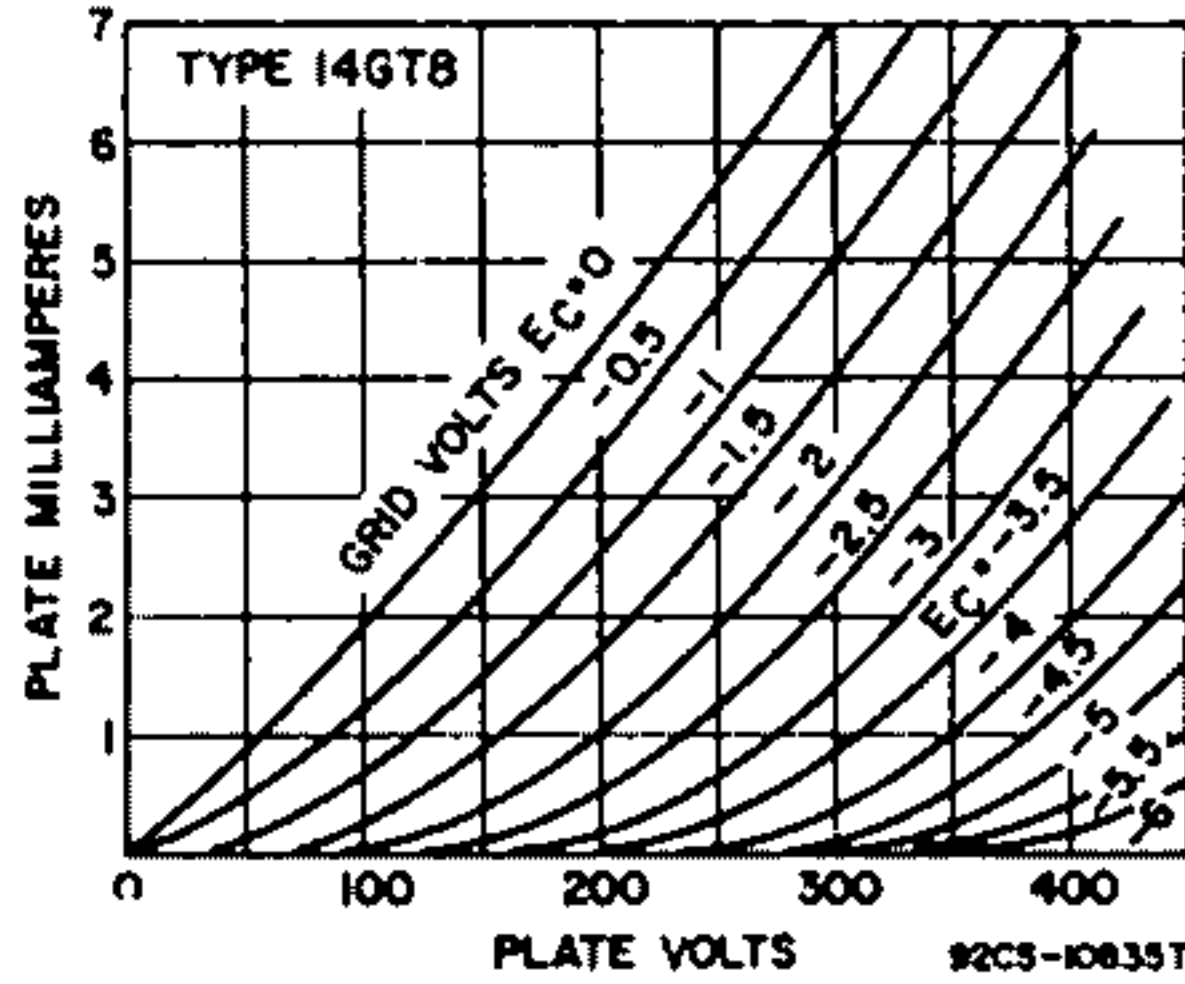
**Diode Units (each unit)**

**MAXIMUM RATINGS (Design-Maximum Values)**

Plate Current .....	5	mA
---------------------	---	----

**CHARACTERISTICS, Instantaneous Value**

Tube Voltage Drop for plate current of 18 mA .....	5	volts
--	---	-------



**14H7**

Refer to chart at end of section.

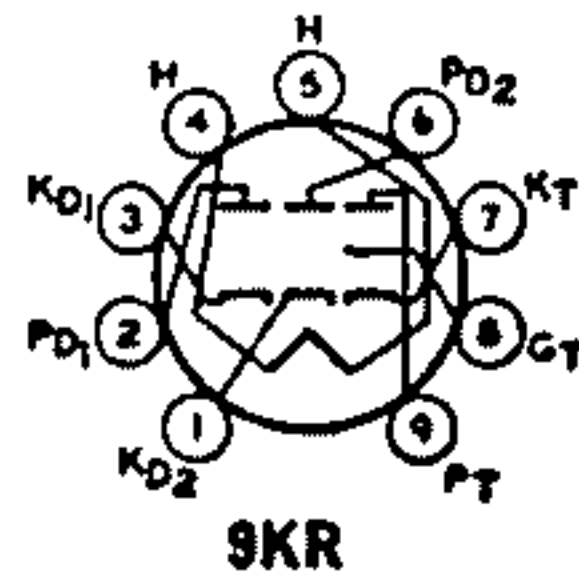
**14J7**

Refer to chart at end of section.

**14JG8**

**TWIN DIODE—  
HIGH-MU TRIODE**

Miniature type used as combined FM detector and af voltage amplifier. Outlines section, 6B; requires miniature 9-contact socket. Heater: volts (ac/dc), 14; amperes, 0.15; maximum heater-cathode volts,  $\pm 200$  peak, 100 average.



**Triode Unit as Class A<sub>1</sub> Amplifier**

**MAXIMUM RATINGS (Design-Maximum Values)**

Plate Voltage .....	330	volts
Grid No.1 (Control-Grid) Voltage:		
Positive-bias value .....	0	volts
Negative-bias value .....	-50	volts
Plate Dissipation .....	1.1	watts

**CHARACTERISTICS**

Plate Voltage .....	250	volts
Grid Voltage .....	-2	volts
Amplification Factor .....	90	
Plate Resistance (Approx.) .....	41000	ohms
Transconductance .....	2200	$\mu$ mbos
Plate Current .....	2	mA

**Diode Units**

**MAXIMUM RATINGS (Design-Maximum Values)**

Plate Current (Each Unit) .....	5	mA
---------------------------------	---	----

**14N7**

Refer to chart at end of section.

**14Q7**

Refer to chart at end of section.

**14R7**

Refer to chart at end of section.

Refer to chart at end of section.

Refer to type 6AF11.

Refer to type 6BD11.

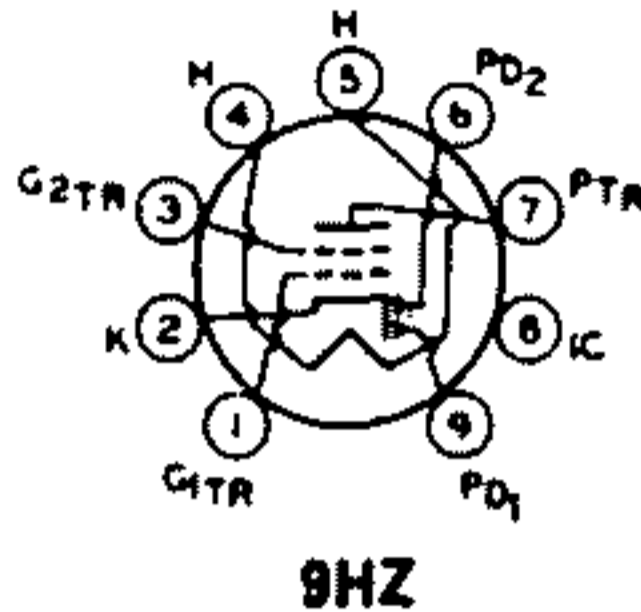
Refer to type 6CW5.

15

15AF11

15BD11

15CW5  
15CW5/PL84



9HZ

**HIGH-MU TRIODE  
SHARP-CUTOFF PENTODE**

**15DQ8**

Miniature type used in color and black-and-white television receiver applications. The triode unit is used as a sync-separator, sync-amplifier, keyed-agc, or noise-suppressor tube. The pentode unit is used as a video-output tube. Outlines section, 6E; requires miniature 9-contact socket.

Heater Voltage (ac/dc) .....	15	volts
Heater Current .....	0.3	ampere
Peak Heater-Cathode Voltage .....	±200 max	volts

**Class A<sub>1</sub> Amplifier**

MAXIMUM RATINGS (Design-Maximum Values)	Triode Unit	Pentode Unit	
Plate Supply Voltage .....	550	550	volts
Peak Plate Voltage, with maximum plate current of 0.1 mA* .....	600	—	volts
Plate Voltage .....	250	250	volts
Grid-No.2 (Screen-Grid) Supply Voltage .....	—	550	volts
Grid-No.2 Voltage .....	—	250	volts
Cathode Current .....	12	40	mA
Plate Dissipation .....	1	4	watts
Grid-No.2 Input .....	—	1.7	watts

CHARACTERISTICS	Triode Unit	Pentode Unit			
Plate Voltage .....	200	170	200	200	volts
Grid-No.2 Voltage .....	—	170	200	220	volts
Grid-No.1 Voltage .....	-1.7	-2.1	-2.9	-3.4	volts
Amplification Factor .....	65	—	—	—	
Mu-Factor, Grid-No.2 to Grid-No.1 .....	—	36	36	36	
Plate Resistance (Approx.) .....	—	0.1	0.18	0.15	megohm
Transconductance .....	4000	11000	10400	10000	μmhos
Plate Current .....	3	18	18	18	mA
Grid-No.2 Current .....	—	3	3	3	mA

**TYPICAL OPERATION OF PENTODE UNIT AS VIDEO OUTPUT TUBE**

Plate Supply Voltage .....	170	200	220	volts
Series Plate Resistor .....	3000	3000	3000	ohms
Grid-No.2 Voltage .....	170	200	220	volts
Grid-No.1 Voltage .....	-2	-2.8	-3.3	volts
Transconductance .....	10400	10000	9700	μmhos
Plate Current .....	18	18	18	mA
Grid-No.2 Current .....	3.2	3.1	3.1	mA

**MAXIMUM CIRCUIT VALUES**

Grid-No.1-Circuit Resistance:	Triode Unit	Pentode Unit	
For fixed-bias operation .....	1	1	megohm
For cathode-bias operation .....	3	2	megohms

\* With maximum duty factor of 0.18 and maximum pulse duration of 18 microseconds.

Refer to type 6FM7.

15FM7

Refer to type 6FY7.

15FY7

Refer to type 6HB6.

15HB6

Refer to type 6KY8A.

15KY8  
15KY8A

Refer to type 6LE8.

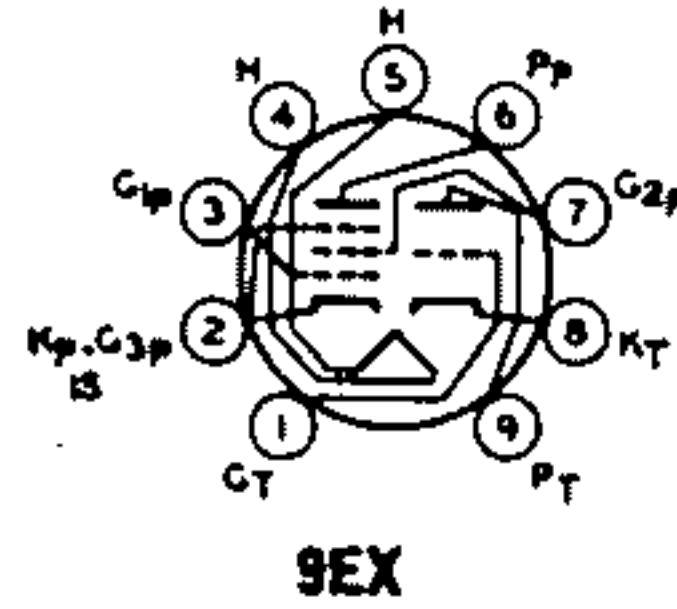
15LE8



# 16A8

## HIGH-MU TRIODE POWER PENTODE

Miniature type used in television receiver applications. The triode unit is used as a vertical oscillator or as an af amplifier, and the pentode unit is used as a vertical output tube or as an audio output tube. Outlines section, 6G; requires 9-contact socket. Heater: volts (ac/dc), 16; amperes, 0.3; maximum heater-cathode volts, ±200.



### Class A<sub>1</sub> Amplifier

MAXIMUM RATINGS (Design-Maximum Values)	Triode Unit	Pentode Unit	
Plate Supply Voltage .....	550	550	volts
Peak Plate Voltage* .....	600	2500	volts
Plate Voltage .....	250	250	volts
Peak Inverse Plate Voltage .....	—	500	volts
Grid-No.2 (Screen-Grid) Supply Voltage .....	—	550	volts
Grid-No.2 Voltage .....	—	250	volts
Cathode Current .....	15	50	mA
Plate Dissipation (Frame Output) .....	—	5	watts
Plate Dissipation (Audio Output) .....	—	7	watts
Grid-No.2 Input .....	—	1.8	watts
Peak Grid-No.2 Input .....	—	3.2	watts

### CHARACTERISTICS

	Triode Unit	Pentode Unit				
Plate Voltage .....	100	100	170	200	200	volts
Grid-No.2 Voltage .....	—	100	170	200	200	volts
Grid-No.1 Voltage .....	0	—6.0	—11.5	—12.5	—16	volts
Amplification Factor .....	70	—	—	—	—	
Mu Factor, Grid No.2 to Grid No.1 .....	—	10	9.5	9.5	9.5	
Plate Resistance .....	—	15000	16000	20500	20000	ohms
Transconductance .....	2500	6800	7500	6800	6400	μmhos
Plate Current .....	3.5	28	41	35	35	mA
Grid-No.2 Current .....	—	6.0	8.0	6.5	7.0	mA

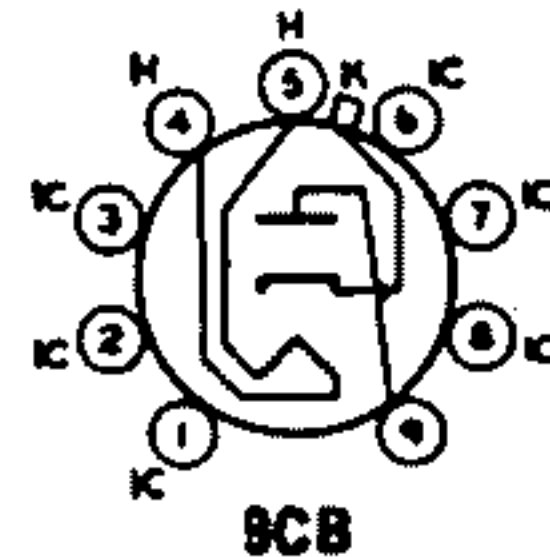
### MAXIMUM CIRCUIT VALUES

Grid-No.1-Circuit Resistance:	Triode Unit	Pentode Unit	
For fixed-bias operation .....	1	1	megohm
For cathode-bias operation .....	3	2	megohms

\* With a maximum duty factor of 0.04 and maximum pulse duration of 0.8 milliseconds.

# 16AQ3 16AQ3/ XY88

## DIODE



Miniature types used as booster diodes in line-time-base circuits of transformerless television receivers.

Outlines section, 7D; require miniature 9-contact socket. Heater: volts (ac/dc), 16.4; amperes, 0.6; maximum heater-cathode volts, 6600 peak.

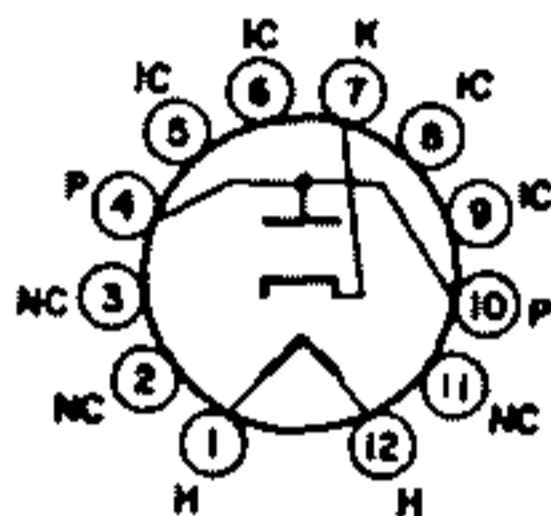
### MAXIMUM RATINGS (Design-Center Values)

Supply Voltage at zero current .....	550	volts
Supply Voltage .....	250	volts
Peak Plate Current .....	550	mA
Average Plate Current .....	220	mA
Plate Dissipation .....	5	watts
Peak Negative-Pulse Plate Voltage* .....	—6000#	volts

\* Under no conditions should an absolute maximum value of 7500 volts be exceeded.

# The pulse duration must not exceed 22 per cent of a cycle, or a maximum of 18 microseconds.

Refer to type 6GK6.	<b>16GK6</b>
Refer to type 6GY5.	<b>16GY5</b>
Refer to type 6AX3.	<b>17AX3</b>
Refer to chart at end of section.	<b>17AX4GT</b>
Refer to type 6AX4GTB.	<b>17AX4GTA</b>
Refer to type 6AY3B.	<b>17AY3</b>
	<b>17AY3A</b>
Refer to type 6BE3.	<b>17BE3</b>
Refer to type 6BF11.	<b>17BF11</b>
Refer to type 6BH3A.	<b>17BH3</b>
	<b>17BH3A</b>
Refer to type 6BQ6GTB/6CU6.	<b>17BQ6GTB</b>
	<b>17BS3</b>
Refer to type 6BS3A.	<b>17BS3A</b>



**12FX**

**HALF-WAVE  
VACUUM RECTIFIER**

**17BZ3**

Duodecar type used as damper tube in horizontal-deflection circuits of television receivers. Outlines section, 8D; requires duodecar 12-contact socket.

Heater Voltage (ac/dc) .....	16.8	volts
Heater Current .....	0.45	ampere
Heater Warm-up Time (Average) .....	11	seconds
Direct Interelectrode Capacitances (Approx.):		
Cathode to Heater and Plate .....	11	pF
Plate to Cathode and Heater .....	8.5	pF
Heater to Cathode .....	8.4	pF

**Damper Service**

For operation in a 525-line, 30-frame system

**MAXIMUM RATINGS (Design-Maximum Values)**

Peak Inverse Plate Voltage# .....	4500	volts	
Peak Plate Current .....	1200	mA	
Average Plate Current .....	200	mA	
Plate Dissipation .....	6.5	watts	
Heater-Cathode Voltage:			
Peak value .....	+900	-4500	volts
Average value .....	+100	-300	volts

**CHARACTERISTICS, Instantaneous Value**

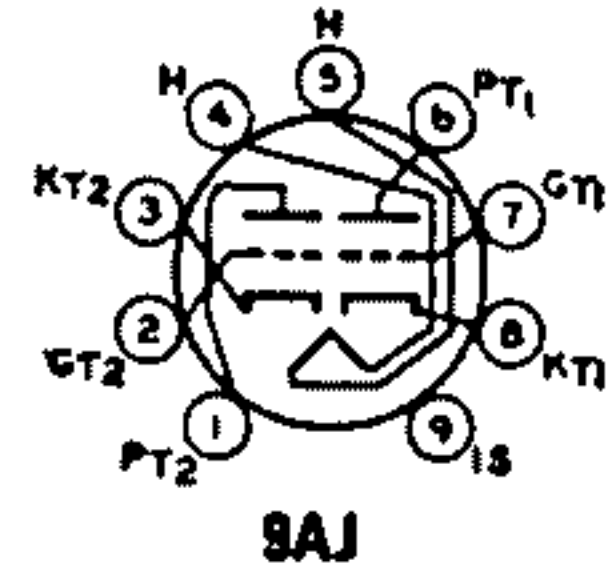
Tube Voltage Drop for plate current of 350 mA .....	21	volts
---	----	-------

# Pulse duration must not exceed 15% of a horizontal scanning cycle (10 microseconds).

Refer to type 50C5.	<b>17C5</b>
Refer to type 6C9.	<b>17C9</b>
Refer to type 6CK3.	<b>17CK3</b>
Refer to type 6CU5.	<b>17CU5</b>
Refer to type 6DA4.	<b>17D4</b>
Refer to type 6DE4.	<b>17DE4</b>
Refer to chart at end of section.	<b>17DM4</b>
Refer to type 6DM4A.	<b>17DM4A</b>
Refer to chart at end of section.	<b>17DQ6A</b>
Refer to type 6DQ6B.	<b>17DQ6B</b>

## 17EW8 HIGH-MU TWIN TRIODE

Miniature types used in rf-amplifier and oscillator-mixer circuits in FM and AM radio receivers. Outlines section, 6B; require miniature 9-contact socket.



Heater Voltage .....	17.5	volts
Heater Current .....	0.15	ampere
Peak Heater-Cathode Voltage .....	±90 max	volts
<b>Direct Interelectrode Capacitances:</b>		
Plate to Grid (Each Unit) .....	1.5	pF
Plate to Cathode (Each Unit) .....	0.18	pF
Plate to Cathode, Heater, and Internal Shield (Each Unit) .....	1.2	pF
Grid to Cathode, Heater, and Internal Shield (Each Unit) .....	3	pF
Plate of Unit No.1 to Plate of Unit No.2 .....	0.04 max	pF
Grid of Unit No.1 to Grid of Unit No.2 .....	0.003 max	pF
Plate of Unit No.1 to Grid of Unit No.2 .....	0.008 max	pF
Plate of Unit No.2 to Grid of Unit No.1 .....	0.008 max	pF
Plate of Unit No.1 to Cathode of Unit No.2 .....	0.008 max	pF
Plate of Unit No.2 to Cathode of Unit No.1 .....	0.008 max	pF
Grid of Unit No.1 to Triode of Unit No.2 .....	0.003 max	pF
Grid of Unit No.2 to Triode of Unit No.1 .....	0.003 max	pF

### Class A<sub>1</sub> Amplifier (Each Unit)

#### MAXIMUM RATINGS (Design-Maximum Values)

Plate Voltage .....	250	volts
Grid-Voltage, Negative-bias Value .....	-100	volts
Cathode Current .....	15	mA
Plate Dissipation .....	2.5	watts

#### CHARACTERISTICS

Plate Voltage .....	100	170	200	volts
Grid Voltage .....	-1.1*	-1.5	-2.1	volts
Amplification Factor .....	50	50	48	
Transconductance .....	4600	6200	5800	μmhos
Plate Current .....	4.5	10	10	mA

#### MAXIMUM CIRCUIT VALUE

Grid-Circuit Resistance .....	1	megohm
-------------------------------	---	--------

\* Should not be used if grid current is not permissible.

<b>17GE5</b>	Refer to type 6GE5.
<b>17GJ5</b>	Refer to chart at end of section.
<b>17GJ5A</b>	Refer to type 6GJ5A.
<b>17GT5</b>	
<b>17GT5A</b>	Refer to type 6GT5A.
<b>17GV5</b>	Refer to type 6GV5.
<b>17GW6/17DQ6B</b>	Refer to type 6GW6/6DQ6B.
<b>17H3</b>	Refer to chart at end of section.
<b>17JB6</b>	
<b>17JB6A</b>	Refer to type 6JB6A.
<b>17JG6</b>	Refer to chart at end of section.
<b>17JG6A</b>	Refer to type 6JG6A.
<b>17JM6</b>	
<b>17JM6A</b>	Refer to type 6JM6A.
<b>17JN6</b>	Refer to type 6JN6.
<b>17JT6</b>	
<b>17JT6A</b>	Refer to type 6JT6A.

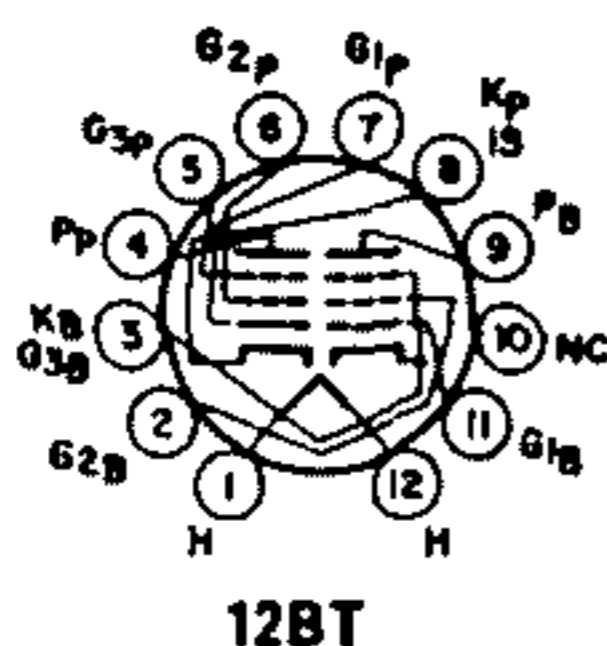


Refer to type 6JZ8.

17JZ8

Refer to chart at end of section.

17LD8



12BT

**PENTODE—  
BEAM POWER TUBE**

**17X10**

Duodecar type used in television receiver applications. The pentode unit is used as a power-output tube, and the beam power unit is used for limiter and discriminator applications. Outlines section, 8C; requires duodecar 12-contact socket. Heater: volts, 16.8; amperes, 0.45; average warm-up time, 11 seconds; maximum heater-cathode volts;  $\pm 200$  peak, 100 average.

**Class A<sub>1</sub> Amplifier**

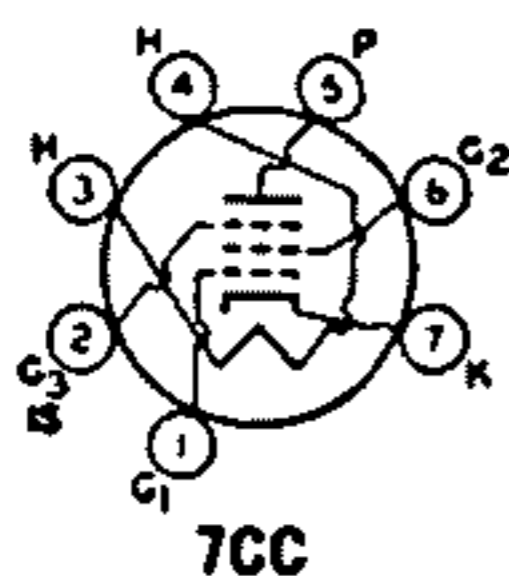
MAXIMUM RATINGS (Design-Maximum Values)	Beam Power Unit	Pentode Unit	
Plate Voltage	165	320	volts
Grid-No.2 (Screen-Grid) Voltage	150	110	volts
Grid-No.1 (Control-Grid) Voltage, Peak positive value	—	60	volts
Cathode Current	65	13	mA
Plate Dissipation	6.6	—	watts
Grid-No.2 Input	1.8	—	watts
CHARACTERISTICS	Beam Power Unit		
Plate Voltage	145		volts
Grid-No.2 Voltage	110		volts
Grid-No.1 Voltage	6		volts
Peak AF Grid Voltage	6		volts
Plate Resistance	80000		ohms
Transconductance	8600		$\mu$ mhos
Zero-Signal Plate Current	36		mA
Maximum-Signal Plate Current	40		mA
Zero-Signal Grid-No.2 Current	3		mA
Maximum-Signal Grid-No.2 Current	9		mA
Load Resistance	3000		ohms
MAXIMUM CIRCUIT VALUES			
Grid-No.1-Circuit Resistance:			
For fixed-bias operation	0.25		megohm
For cathode-bias operation	0.5		megohm

Refer to chart at end of section.

18A5

Refer to chart at end of section.

18FW6



7CC

**REMOTE-CUTOFF PENTODE**

**18FW6A**

Miniature type used as rf- and if-amplifier tube in ac/dc radio receivers. Outlines section, 5C; requires miniature 7-contact socket.

Heater Voltage	18	volts
Heater Current	0.1	ampere
Heater Warm-up Time (Average)	20	seconds
Peak Heater-Cathode Voltage	$\pm 100$ max	volts
Direct Interelectrode Capacitances:		
Grid No.1 to Plate	0.0035 max	
Grid No.1 to Cathode, Heater, Grid No.2, and Grid No.3	5.5	pF
Plate to Cathode, Heater, Grid No.2, and Grid No.3	5	pF

**Class A<sub>1</sub> Amplifier**

MAXIMUM RATINGS (Design-Maximum Values)		
Plate Voltage	150	volts
Grid-No.2 (Screen-Grid) Supply Voltage	150	volts
Grid-No.2 Voltage	See curve page 98	
Grid-No.1 (Control-Grid) Voltage, Positive-bias value	0	volts

Plate Dissipation .....	2.5	watts
Grid-No.2 Input:		
For grid-No.2 voltages up to 75 volts .....	0.6	watt
For grid-No.2 voltages between 75 and 150 volts .....		See curve page 96

**CHARACTERISTICS**

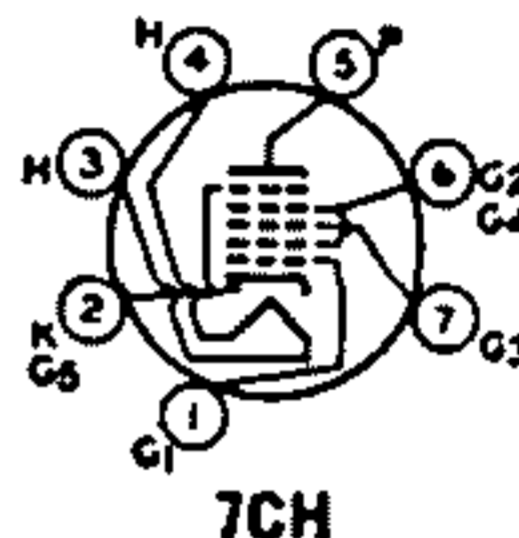
Plate Supply Voltage .....	100	volts
Grid No.3 .....	Connected to cathode at socket	
Grid-No.2 Supply Voltage .....	100	volts
Cathode-Bias Resistor .....	68	ohms
Plate Resistance (Approx.) .....	0.25	megohm
Transconductance .....	4400	$\mu$ mhos
Plate Current .....	11	mA
Grid-No.2 Current .....	4.4	mA
Grid-No.1 Voltage (Approx.) for transconductance of 25 $\mu$ mhos .....	-20	volts

**18FX6**

Refer to chart at end of section.

**18FX6A PENTAGRID CONVERTER**

Miniature type used for converter applications in ac/dc radio receivers. Outlines section, 5C; requires miniature 7-contact socket. Heater: volts (ac/dc), 18; amperes, 0.1; warm-up time (average), 20 seconds; maximum heater-cathode volts,  $\pm 100$  peak.



**Converter**

**MAXIMUM RATINGS (Design-Maximum Values)**

Plate Voltage .....	150	volts
Grids-No.2-and-No.4 (Screen-Grid) Supply Voltage .....	150	volts
Grids-No.2-and-No.4 Voltage .....	110	volts
Grids-No.2-and-No.4 Input .....	1.2	watts
Plate Dissipation .....	1	watt

**TPYICAL OPERATION (Separate Excitation)\***

Plate Voltage .....	100	volts
Grids-No.2-and-No.4 (Screen-Grid) Voltage .....	100	volts
Grid-No.3 (Control-Grid) Voltage .....	-1.5	volts
Grid-No.1 (Oscillator-Grid) Resistor .....	20000	ohms
Plate Resistance (Approx.) .....	0.4	megohm
Conversion Transconductance .....	480	$\mu$ mhos
Plate Current .....	2.3	mA
Grids-No.2-and-No.4 Current .....	6.2	mA
Grid-No.1 Current .....	0.5	mA
Total Cathode Current .....	9	mA
Grid-No.3 Voltage (Approx.) for conversion transconductance of 10 $\mu$ mhos .....	-21	volts

NOTE: The transconductance between grid No.1 and grids No.2 and No.4 connected to plate (not oscillating) is approximately 7000  $\mu$ mhos under the following conditions: grids No.1 and No.3 at 0 volts; grids No.2 and No.4 and plate at 100 volts. Under the same conditions, the plate current is 24  $\mu$ A, and the amplification factor is 22.

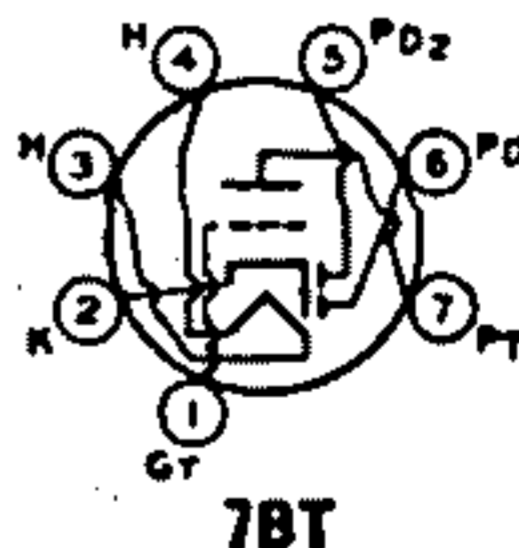
\* The characteristics shown with separate excitation correspond very closely with those obtained in a self-excited oscillator circuit operating with zero bias.

**18FY6**

Refer to chart at end of section.

**18FY6A TWIN DIODE—HIGH-MU TRIODE**

Miniature type used as combined detector, amplifier, and avc tube in compact ac/dc radio receivers. Outlines section, 5C; requires miniature 7-contact socket. Heater: volts (ac/dc), 18; amperes, 0.1; warm-up time (average), 20 seconds; maximum heater-cathode volts,  $\pm 100$  peak.



**Triode Unit as Class A<sub>1</sub> Amplifier**

**MAXIMUM RATINGS (Design-Maximum Values)**

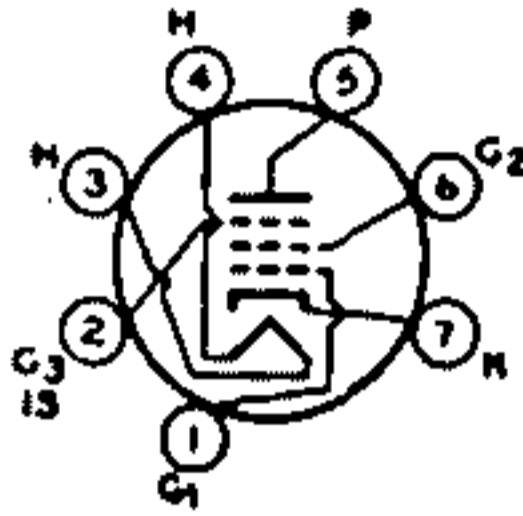
Plate Voltage .....	150	volts
Grid Voltage, Positive-bias value .....	0	volts
Plate Dissipation .....	0.5	watt

**CHARACTERISTICS**

Plate Voltage .....	100	volts
Grid Voltage .....	-1	volt
Amplification Factor .....	100	
Plate Resistance (Approx.) .....	77000	ohms
Transconductance .....	1300	μmhos
Plate Current .....	0.6	mA

**Diode Units (Each Unit)**

<b>MAXIMUM RATINGS (Design-Maximum Values)</b>		
Plate Current .....	1	mA



7BK

**SHARP-CUTOFF PENTODE 18GD6A**

Miniature type used in the if, rf, and converter stages of ac/dc AM radio receivers. Outlines section, 5C; requires miniature 7-contact socket.

Heater Voltage (ac/dc) .....	18	volts
Heater Current .....	0.1	ampere
Warm-up Time (Average) .....	20	seconds
Peak Heater-Cathode Voltage .....	±100 max	volts
<b>Direct Interelectrode Capacitances:*</b>		
Grid No.1 to Plate .....	0.0035	pF
Grid No.1 to Cathode, Heater, Grid No.2, Grid No.3, and Internal Shield .....	6.0	pF
Plate to Cathode, Heater, Grid No.2, Grid No.3 and Internal Shield .....	5.0	pF

\* Values are same without external shield, or with external shield connected to cathode.

**Class A<sub>1</sub> Amplifier**

**CHARACTERISTICS**

Plate Supply Voltage .....	100	volts
Grid No.3 (Suppressor Grid) .....	Connected to cathode at socket	
Grid-No.2 (Screen-Grid) Voltage .....	100	volts
Cathode-Bias Resistor .....	150	ohms
Plate Resistance (Approx.) .....	0.5	megohm
Transconductance .....	4300	μmhos
Plate Current .....	5	mA
Grid-No.2 Current .....	2	mA
Grid-No.1 Voltage (Approx.) for plate current of 10 μA .....	-4.7	volts

**RF Amplifier and Converter**

**MAXIMUM RATINGS (Design-Maximum Values)**

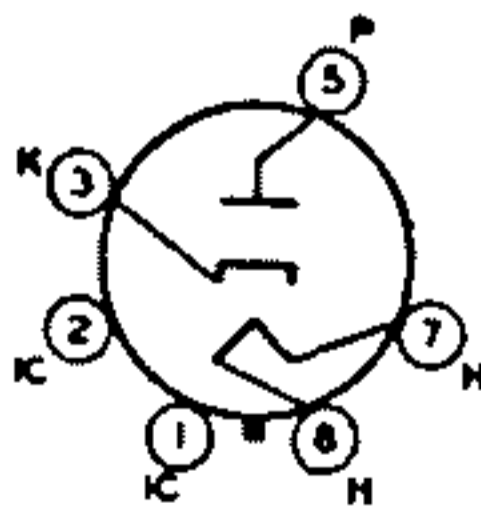
Plate Voltage .....	150	volts
Grid-No.2 Supply Voltage .....	150	volts
Grid-No.2 Voltage .....	See curve page 96	
Plate Dissipation .....	2.5	watts
Grid-No.2 Input:		
For grid-No.2 voltages up to 75 volts .....	0.6	watt
For grid-No.2 voltages between 75 and 150 volts .....	See curve page 96	

Refer to chart at end of section.

19

**HALF-WAVE VACUUM RECTIFIER**

**19AU4**



4CG

Glass octal type used as damper diode in horizontal-deflection circuits of black-and-white television receivers. Outlines section, 13G; requires octal socket. This type may be supplied with pin 1 omitted. Socket terminals 1, 2, 4, and 6 should not be used as tie points. This tube, like other power-handling tubes, should be adequately ventilated.

Heater Voltage (ac/dc) .....	18.9	volts
Heater Current .....	0.6	ampere
Heater Warm-up Time .....	11	seconds



Direct Interelectrode Capacitances:

Plate to Heater and Cathode .....	8.5	pF
Cathode to Heater and Plate .....	11.5	pF
Heater to Cathode .....	4	pF

**Damper Service**

For operation in a 525-line, 30-frame system

**MAXIMUM RATINGS (Design-Center Values)**

Peak Inverse Plate Voltage# .....	4500*	volts	
Peak Plate Current .....	1050	mA	
Average Plate Current .....	175	mA	
Plate Dissipation .....	6	watts	
<b>Heater-Cathode Voltage:</b>			
Peak value .....	+300	-4500	volts
Average value .....	+100	-900	volts

# Pulse duration must not exceed 15% of a horizontal scanning cycle (10 microseconds).

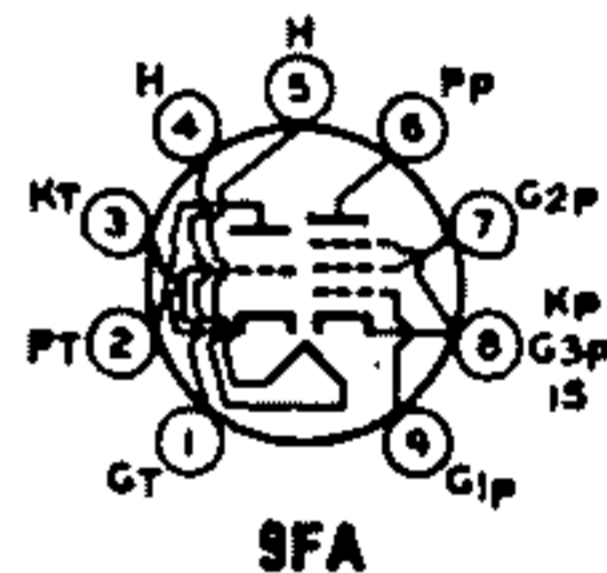
\* Under no circumstances should this absolute value be exceeded.

- 19AU4GTA** Refer to chart at end of section.
- 19BG6G**
- 19BG6GA** Refer to chart at end of section.
- 19CL8A** Refer to type 6CL8A.
- 19EA8** Refer to type 6EA8.
- 19EZ8** Refer to type 6EZ8.
- 19GQ7** Refer to type 6GQ7.
- 19HR6** Refer to type 6HR6.
- 19HS6** Refer to type 6HS6.

**19HV8**

**HIGH-MU TRIODE—  
SHARP-CUTOFF PENTODE**

Miniature type used as if-amplifier and af voltage-amplifier tube in radio receivers. Outlines section, 6B; requires miniature 9-contact socket.



Heater Voltage (ac/dc) .....	18.9	volts	
Heater Current .....	0.15	ampere	
<b>Heater-Cathode Voltage:</b>			
Peak value .....	±200 max	volts	
Average value .....	100 max	volts	
<b>Direct Interelectrode Capacitances:</b>			
	<b>Unshielded</b>	<b>Shielded</b>	
<b>Pentode Unit:</b>			
Grid No.1 to Plate .....	0.016	0.007	pF
Grid No.1 to Cathode, Heater, Grid No.2, Grid No.3, and Internal Shield .....	5.5	5.5	pF
Plate to Cathode, Heater, Grid No.2, Grid No.3, and Internal Shield .....	2.4	3.4	pF
Heater to Cathode .....	2.8	2.8	pF
<b>Triode Unit:</b>			
Grid to Plate .....	0.9	0.9	pF
Grid to Cathode, Cathode of Pentode Unit, Heater, Grid No.3, and Internal Shield .....	1.7	1.9	pF
Plate to Cathode, Cathode of Pentode Unit, Heater, Grid No.3, and Internal Shield .....	1.7	2.6	pF
Heater to Cathode .....	2.8	2.8	pF

**Class A<sub>1</sub> Amplifier**

<b>MAXIMUM RATINGS (Design-Maximum Values)</b>			
Plate Voltage .....	330	330	volts
Grid-No.2 (Screen-Grid) Supply Voltage .....	—	330	volts
Grid-No.2 Voltage .....	—	See curve page 96	
Grid-No.1 (Control-Grid) Voltage, Positive-bias value .....	0	0	volts
Plate Dissipation .....	0.55	3	watts

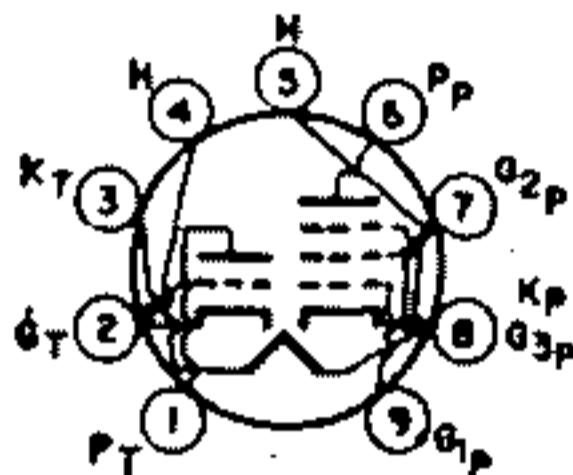
Grid-No.2 Input:			
For grid-No.2 voltages up to 165 volts	—	0.55	watt
For grid-No.2 voltages between 165 and 330 volts	—	See curve page 96	
<b>CHARACTERISTICS</b>			
Plate Voltage	100	125	volts
Grid-No.2 Voltage	—	125	volts
Grid-No.1 Voltage	—1	—1	volt
Amplification Factor	70	—	
Plate Resistance (Approx.)	54000	200000	ohms
Transconductance	1300	6500	μmhos
Plate Current	0.8	12	mA
Grid-No.2 Current	—	4	mA
Grid-No.1 Voltage (Approx.) for plate current of 50 μA	—1.5	—	volts
Grid-No.1 Voltage (Approx.) for plate current of 20 μA	—	—9	volts
<b>MAXIMUM CIRCUIT VALUES</b>			
Grid-No.1-Circuit Resistance:			
For fixed-bias operation	0.5	0.25	megohm
For cathode-bias operation	1	1	megohm

Refer to chart at end of section.

19J6

Refer to type 6JN8.

19JN8



9LY

**MEDIUM-MU TRIODE—  
SHARP-CUTOFF PENTODE**

**19KG8**

Miniature type used as combined oscillator and mixer. Outlines section, 6B; requires miniature 9-contact socket. Heater: volts (ac/dc), 18.9; amperes, 0.15; maximum heater-cathode volts, ±200 peak, 100 average.

**Class A<sub>1</sub> Amplifier**

<b>MAXIMUM RATINGS (Design-Maximum Values)</b>	<b>Triode Unit</b>	<b>Pentode Unit</b>	
Plate Voltage	300	300	volts
Grid No.2 (Screen-Grid) Supply Voltage	—	300	volts
Grid No.2 Voltage	—	See curve page 96	
Grid No.1 (Control-Grid) Voltage, Positive-bias value	0	0	volts
Plate Dissipation	2.5	2.5	watts
Grid No.2 Input:			
For grid-No.2 voltages up to 150 volts	—	0.55	watt
For grid-No.2 voltages between 150 and 300 volts	—	See curve page 96	
<b>CHARACTERISTICS</b>			
Plate Voltage	125	125	volts
Grid-No.2 Voltage	—	125	volts
Grid-No.1 Voltage	—1.0	—1.0	volts
Amplification Factor	46	—	
Plate Resistance (Approx.)	5400	200000	ohms
Transconductance	8500	7500	μmhos
Plate Current	13.5	12	mA
Grid-No.2 Current	—	4.0	mA
Grid-No.1 Voltage (Approx.) for plate current of 10 μA	—8	—8	volts
<b>MAXIMUM CIRCUIT VALUES</b>			
Grid-No.1-Circuit Resistance:			
For fixed-bias operation	2.2	2.2	megohms
For cathode-bias operation	2.2	2.2	megohms

Refer to chart at end of section.

19T8

Refer to type 6X8.

19X8

Refer to chart at end of section.

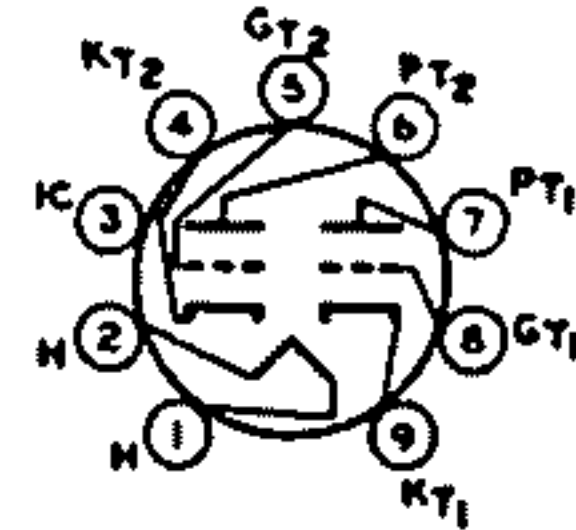
20

Refer to chart at end of section.

20EQ7

## 20EZ7 HIGH-MU TWIN TRIODE

Miniature type used in high-gain, resistance-coupled, low-level audio amplifiers such as preamplifiers for stereo phonographs. Outlines section, 6B; requires miniature 9-contact socket. For typical operation as resistance-coupled amplifier, refer to Resistance-Coupled Amplifier section.



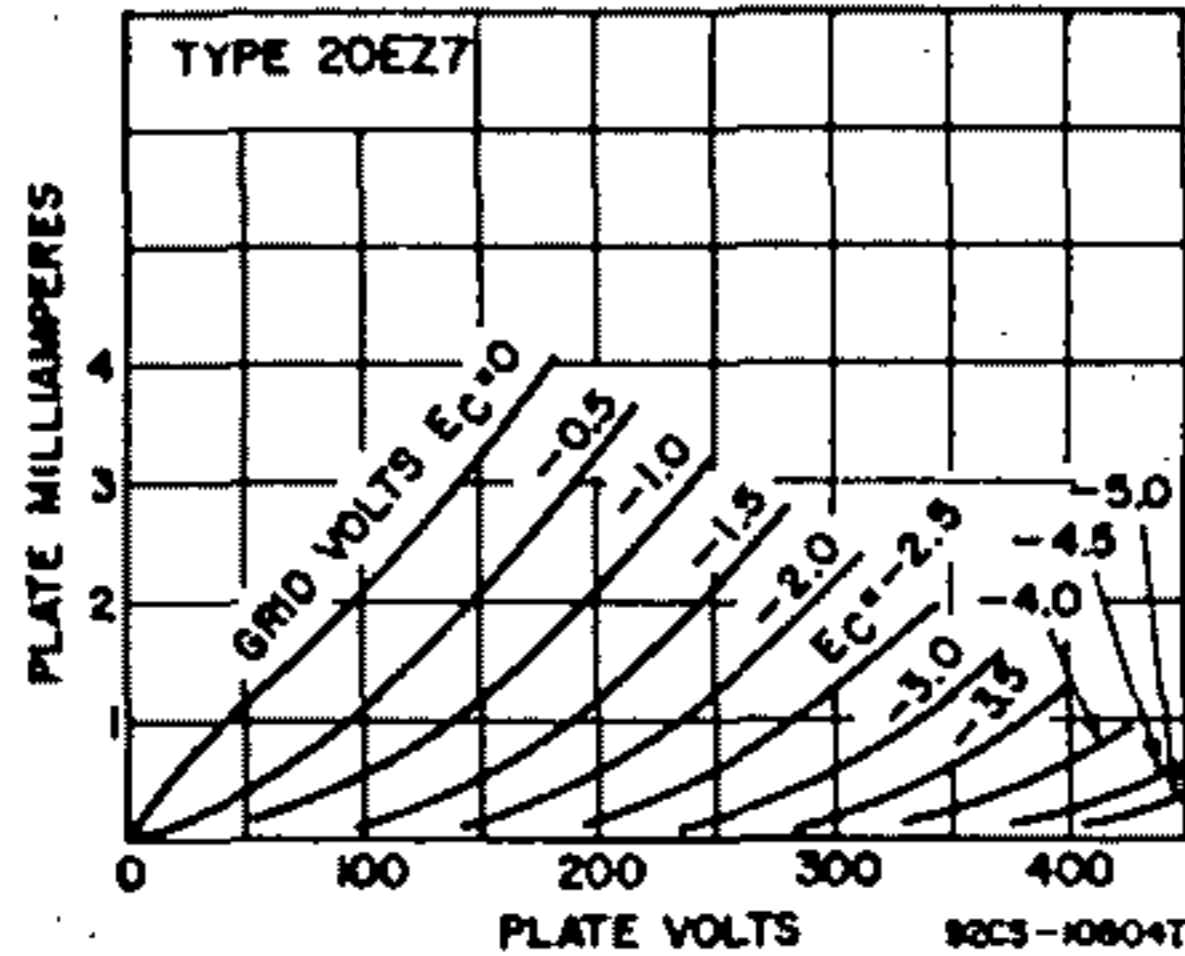
9PG

Heater Voltage (ac/dc)	20	volts	
Heater Current	0.1	ampere	
Heater Warm-up Time (Average)	20	seconds	
Heater-Cathode Voltage:			
Peak value	±200 max	volts	
Average value	100 max	volts	
Direct Interelectrode Capacitances:	Unit No.1	Unit No.2	
Grid to Plate	1.5	1.5	pF
Grid to Cathode and Heater	1.6	1.6	pF
Plate to Cathode and Heater	0.2	0.3	pF

### Class A<sub>1</sub> Amplifier (Each Unit)

<b>MAXIMUM RATINGS (Design-Maximum Values)</b>		
Plate Voltage	330	volts
Grid Voltage:		
Negative-bias value	-55	volts
Positive-bias value	0	volts
Plate Dissipation	1.2	watts

<b>CHARACTERISTICS</b>			
Plate Voltage	100	250	volts
Grid Voltage	-1	-2	volts
Amplification Factor	100	100	
Plate Resistance (Approx.)	80000	62500	ohms
Transconductance	1250	1600	μmhos
Plate Current	0.5	1.2	mA



**21EX6**

Refer to chart at end of section.

**21GY5**

Refer to type 6GY5.

**21HB5**

Refer to type 6HB5.

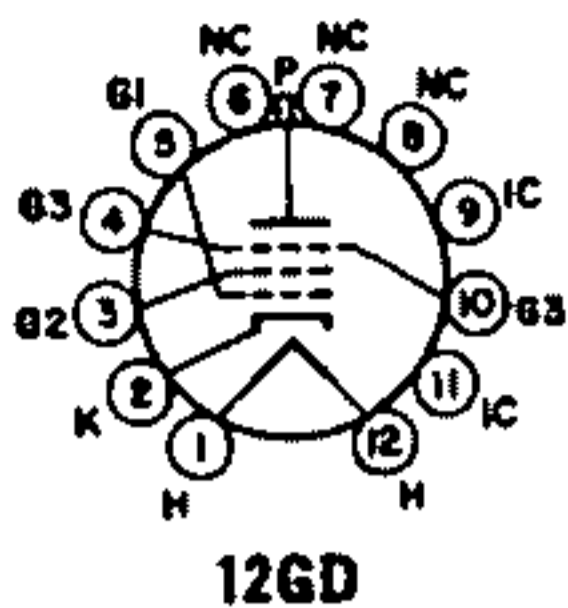
**21HJ5**

Refer to type 6HJ5.

**21JV6**

Refer to type 33JV6.





**BEAM POWER TUBE**

**21JZ6**

Duodecar type used as horizontal-deflection amplifier in television receivers. Outlines section, 15C; requires duodecar 12-contact socket. Heater: volts (ac/dc), 21; amperes, 0.45; average warm-up time, 11 seconds; maximum heater-cathode volts, ±200 peak, 100 average.

**Class A<sub>1</sub> Amplifier**

**CHARACTERISTICS**

	Triode <sup>A</sup> Connection		Pentode Connection		
	130	5000	50	130	
Plate Voltage .....	130	5000	50	130	volts
Grid No.3 (Suppressor Grid) .....	Connected to cathode at socket				volts
Grid-No.2 (Screen-Grid) Voltage .....	—	130	130	130	volts
Grid-No.1 (Control-Grid) Voltage .....	-20	—	0	-20	volts
Amplification Factor .....	4.8	—	—	—	
Plate Resistance (Approx.) .....	—	—	—	9900	ohms
Transconductance .....	—	—	—	9000	μmhos
Plate Current .....	—	—	450	48	mA
Grid-No.2 Current .....	—	—	29	1.8	mA
Grid-No.1 Voltage (Approx.) for plate current of 1.0 mA .....	—	-64	—	-32	volts

<sup>A</sup> Grid No.2 connected to plate.

**Horizontal-Deflection Amplifier**

For operation in a 525-line, 30-frame system

**MAXIMUM RATINGS (Design-Maximum Values)**

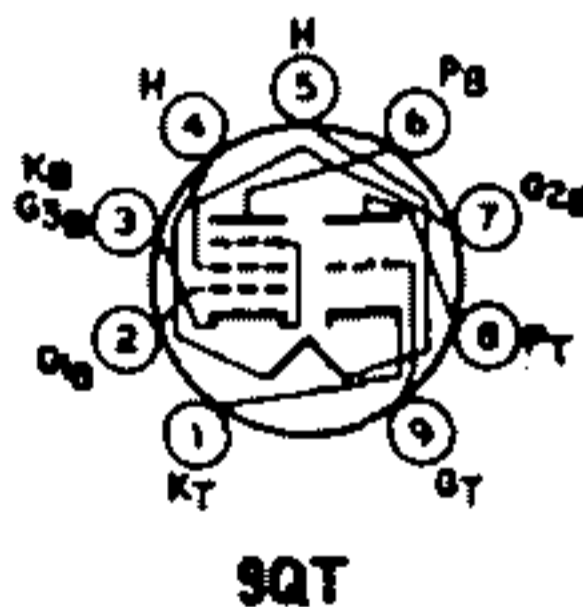
Plate Supply Voltage .....	770	volts
Peak Positive-Pulse Plate Voltage <sup>#</sup> .....	6500	volts
Peak Negative-Pulse Plate Voltage .....	1500	volts
DC Grid-No.3 Voltage, Positive-bias value .....	70	volts
Grid-No.2 Voltage .....	220	volts
DC Grid-No.1 Voltage, Negative-bias value .....	-55	volts
Peak Negative-Pulse Grid-No.1 Voltage .....	-330	volts
Peak Cathode Current .....	800	mA
Average Cathode Current .....	230	mA
Plate Dissipation* .....	18	watts
Grid-No.2 Input .....	2.5	watts
Bulb Temperature (At hottest point) .....	220	°C

**MAXIMUM CIRCUIT VALUE**

Grid-No.1-Circuit Resistance .....	1.0	megohm
------------------------------------	-----	--------

\* A bias resistor or other means is required to protect the tube in absence of excitation.

<sup>#</sup> Pulse duration must not exceed 15% of a horizontal scanning cycle (10 microseconds).



**HIGH-MU TRIODE—  
BEAM POWER TUBE**

**21LR8**

Novar type used in combined vertical-deflection-oscillator and vertical-deflection-amplifier applications in color and black-and-white television receivers. Outlines section, 17E; requires novar 9-contact socket. Heater: volts, 21; amperes, 0.45; average warm-up time, 11 seconds; maximum heater-cathode volts, ±200 peak, 100 average.

**Class A<sub>1</sub> Amplifier**

	Triode Unit		Beam Power Unit		
	250	45	135	120	
Plate Voltage .....	—	125	120	120*	volts
Grid-No.2 (Screen-Grid) Voltage .....	-4	0	-10	-10	volts
Grid-No.1 (Control-Grid) Voltage .....	58	—	—	6.5	
Amplification Factor .....	14000	—	14000	—	ohms
Plate Resistance (Approx.) .....	4100	—	9200	—	μmhos
Transconductance .....	2.6	200*	51	—	mA
Plate Current .....	—	200*	2	—	mA
Grid-No.2 Current .....	—	—	—	—	

**Grid-No.1 Voltage:**

For plate current of 10 $\mu$ A .....	-6.6	—	—	—	volts
For plate current of 100 $\mu$ A .....	—	—	-28	—	volts
For plate current of 1 mA .....	—	—	-24	—	volts

\* Triode connection, Grid No.2 connected to plate at socket.

† This value can be measured by a method involving a recurrent waveform such that the maximum ratings of the tube will not be exceeded.

**Vertical-Deflection Oscillator and Amplifier**

For operation in a 525-line, 30-frame system

MAXIMUM RATINGS (Design-Maximum Values)	Triode Unit		Beam Power Unit	
	Oscillator	Amplifier		
Plate Voltage .....	400	400		volts
Grid-No.2 Voltage .....	—	300		volts
Peak Positive-Pulse Plate Voltage <sup>#</sup> .....	—	2500		volts
Peak Negative-Pulse Grid-No.1 Voltage .....	-400	-250		volts
Peak Cathode Current .....	105	260		mA
Average Cathode Current .....	30	75		mA
Peak Power Output .....	2.5	—		watts
Plate Dissipation <sup>†</sup> .....	2.5	14		watts
Grid-No.2 Input <sup>†</sup> .....	—	2.75		watts
Bulb Temperature .....	—	210		°C

**MAXIMUM CIRCUIT VALUES**

<b>Grid-No.1-Circuit Resistance:</b>			
For fixed-bias operation .....	—	1.0	megohms
For cathode-bias operation .....	2.2	2.2	megohms

<sup>#</sup> Pulse duration must not exceed 15% of a horizontal scanning cycle (10 microseconds).

<sup>†</sup> A bias resistor or other means is required to protect the tube in absence of excitation.

**22**

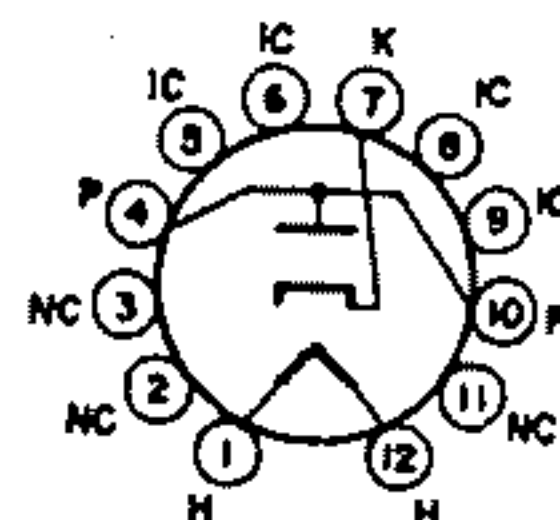
Refer to chart at end of section.

**22BH3  
22BH3A**

Refer to type 6BH3A.

**22BW3**

**HALF-WAVE  
VACUUM RECTIFIER**



**12FX**

Duodecar type used as damper tube in horizontal-deflection circuits of television receivers. Outlines section, 8D; requires duodecar 12-contact socket.

Heater Voltage (ac/dc) .....	22.4	volts
Heater Current .....	0.45	ampere
Heater Warm-up Time .....	11	seconds
<b>Direct Interelectrode Capacitances:</b>		
Cathode to Heater and Plate .....	8.5	pF
Plate to Cathode and Heater .....	6.0	pF
Heater to Cathode .....	3.8	pF

**Damper Service**

For operation in a 525-line, 30-frame system

MAXIMUM RATINGS (Design-Maximum Values)			
Peak Inverse Plate Voltage <sup>#</sup> .....		5000	volts
Peak Plate Current .....		1100	mA
Average Plate Current .....		175	mA
Plate Dissipation .....		6.5	watts
<b>Heater-Cathode Voltage:</b>			
Peak value .....	+300	-5000	volts
Average value .....	+100	-900	volts

**CHARACTERISTICS, Instantaneous Value**

Tube Voltage Drop for plate current of 350 mA .....	32	volts
---	----	-------

<sup>#</sup> Pulse duration must not exceed 15% of one horizontal scanning cycle (10 microseconds).

**22DE4**

Refer to type 6DE4.

**22JF6**

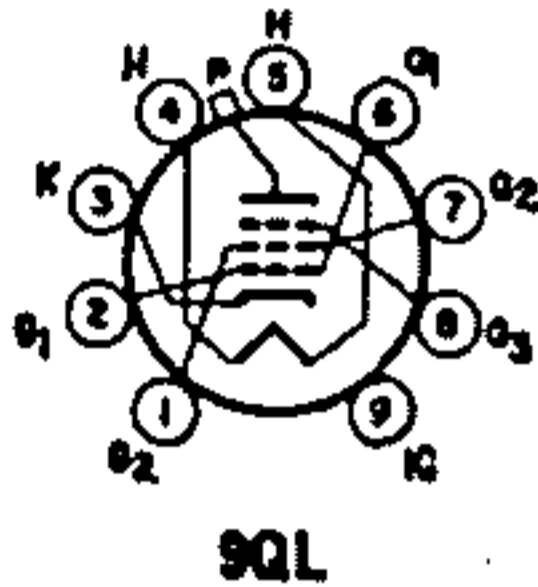
Refer to chart at end of section.

**22JG6**

Refer to chart at end of section.

Refer to type 6JG6A.

22JG6A



9QL

**BEAM POWER TUBE**

**22JU6**

Novar type used as horizontal deflection amplifier in low-B+ black-and-white television receivers. Outlines section, 18A; requires novar 9-contact socket.

Heater Voltage (ac/dc)	22	volts
Heater Current	0.45	ampere
Heater Warm-up Time (Average)	11	seconds
Heater-Cathode Voltage:		
Peak value	±200 max	volts
Average value	100 max	volts
Direct Interelectrode Capacitances:		
Grid No.1 to Plate	1.2	pF
Grid No.1 to Cathode, Heater, Grid No.2, and Grid No.3	22	pF
Plate to Cathode, Heater, Grid No.2, and Grid No.3	9	pF

**Class A<sub>1</sub> Amplifier**

**CHARACTERISTICS**

	Triode Connection*	Pentode Connection	
Plate Voltage	125	50 130	volts
Grid No. 3 (Suppressor Grid)	Connected to cathode at socket		
Grid-No.2 (Screen-Grid) Voltage	—	125	volts
Grid-No.1 (Control-Grid) Voltage	-20	0 -20	volts
Amplification Factor	5	—	
Plate Resistance (Approx.)	—	18000	ohms
Transconductance	—	7000	μmhos
Plate Current	—	470*	mA
Grid-No.2 Current	—	28*	mA
Grid-No.1 Voltage (Approx.) for plate current of 1 mA	—	— -32	volts

\* Grid No.2 connected to plate.  
 \* This value can be measured by a method involving a recurrent waveform such that the maximum ratings of the tube will not be exceeded.

**Horizontal-Deflection Amplifier**

For operation in a 525-line, 30-frame system

**MAXIMUM RATINGS (Design-Maximum Values)**

DC Plate Supply Voltage	770	volts
Peak Positive-Pulse Plate Voltage†	6500	volts
Peak Negative-Pulse Plate Voltage	-1500	volts
DC Grid-No.3 Voltage‡	75	volts
DC Grid No.2 Voltage	220	volts
DC Grid-No.1 Voltage	-55	volts
Peak Negative-Pulse Grid-No.1 Voltage	-330	volts
Peak Cathode Current	850	mA
Average Cathode Current	245	mA
Plate Dissipation†	17	watts
Grid-No.2 Input	3.5	watts
Bulb Temperature (At hottest point)	240	°C

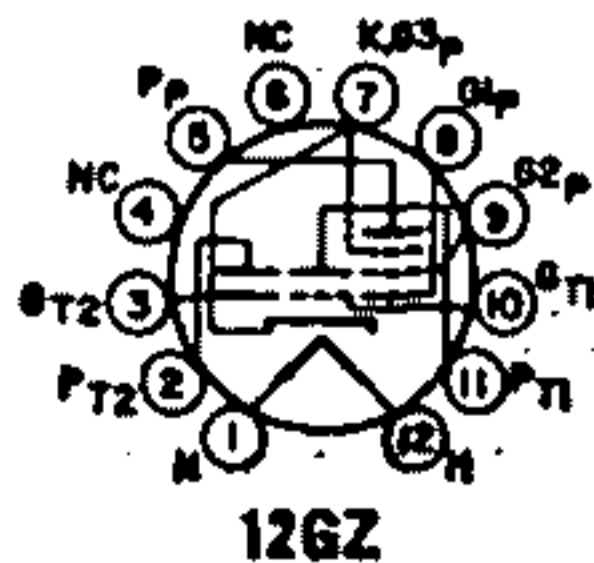
**MAXIMUM CIRCUIT VALUE**

Grid-No.1-Circuit Resistance, for grid-No.1-resistor-bias operation	2.2	megohms
---	-----	---------

‡ In this service, a positive voltage may be applied to grid No.3 to minimize "snivets" interference; a typical value for this voltage is 30 volts.

† A bias resistor or other means is required to protect the tube in absence of excitation.

‡ Pulse duration must not exceed 15% of a horizontal scanning cycle (10 microseconds).



12GZ

**DUAL TRIODE—  
BEAM POWER TUBE**

**23Z9**

Duodecar type used in combined vertical-deflection-oscillator and vertical-deflection-amplifier applications in television receivers. Outlines section, 8B; requires duodecar 12-contact socket. Heater: volts (ac/dc), 28; amperes, 0.45; average warm-up time, 11 seconds;



maximum heater-cathode volts,  $\pm 200$  peak, 100 average.

### Class A<sub>1</sub> Amplifier

CHARACTERISTICS	Triode	Triode	Beam Power		
	Unit No.1	Unit No.2	Unit	Unit	
Plate Voltage	150	150	45	120	volts
Grid-No.2 (Screen-Grid) Voltage	—	—	110	110	volts
Grid-No.1 (Control-Grid) Voltage	—2	—5	0	—8	volts
Amplification Factor	43	20	—	—	
Plate Resistance (Approx.)	11000	8500	—	11700	ohms
Transconductance	3900	2350	—	7100	$\mu$ mbos
Plate Current	5.4	5.5	122	48	mA
Grid-No.2 Current	—	—	16.5	3.5	mA
Grid-No.1 Voltage (Approx.) for plate current of 100 $\mu$ A	—	—	—	—25	volts
Grid Voltage (Approx.) for plate current of 10 $\mu$ A	—5.7	—11	—	—	volts

### Vertical-Deflection Oscillator and Amplifier

For operation in a 525-line, 30-frame system

MAXIMUM RATINGS (Design-Maximum Values)	Triode	Triode	Beam Power	
	Unit No.1 Amplifier	Unit No.2 Oscillator	Unit Amplifier	
Plate Voltage	350	250	250	volts
Peak Positive-Pulse Plate Voltage <sup>#</sup>	—	—	2000	volts
Grid-No.2 Voltage	—	—	200	volts
Peak Negative-Pulse Grid-No.1 Voltage	—	—400	150	volts
Grid Voltage, Positive-bias value	0	—	—	volts
Plate Dissipation	125	1.0	7.0	watts
Grid-No.2 Input	—	—	1.8	watts
Peak Cathode Current	—	—	245	mA
Average Cathode Current	—	—	70	mA
Peak Plate Current	—	70	—	mA
Average Plate Current	—	20	—	mA

#### MAXIMUM CIRCUIT VALUES

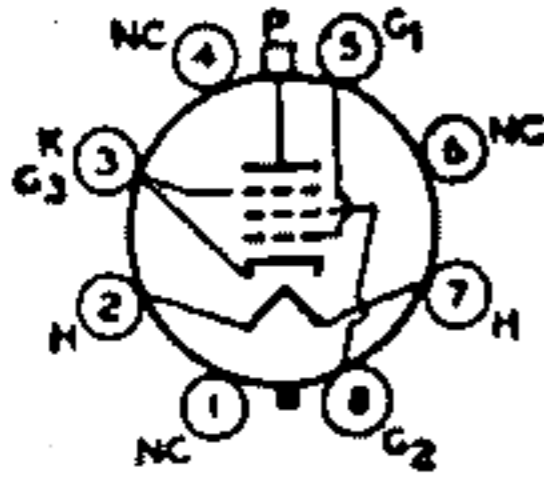
Grid-No.1-Circuit Resistance: For fixed-bias operation	0.5	1.0	1.0	megohms
---	-----	-----	-----	---------

<sup>#</sup> Pulse duration must not exceed 15% of a horizontal scanning cycle (10 microseconds).

<b>24A</b>	Refer to chart at end of section.
<b>24JE6A</b>	Refer to type 6JE6A.
<b>25A6</b>	Refer to chart at end of section.
<b>25A6GT</b>	Refer to chart at end of section.
<b>25A7GT</b>	Refer to chart at end of section.
<b>25AC5GT</b>	Refer to chart at end of section.
<b>25AV5GA</b>	Refer to type 6AV5GA.
<b>25AX4GT</b>	Refer to type 6AX4GTB.
<b>25B5</b>	Refer to chart at end of section.
<b>25B6G</b>	Refer to chart at end of section.
<b>25B8GT</b>	Refer to chart at end of section.
<b>25BK5</b>	Refer to chart at end of section.
<b>25BQ6GT</b>	Refer to chart at end of section.
<b>25BQ6GTB/25CU6</b>	Refer to type 6BQ6GTB/6CU6.
<b>25C5</b>	Refer to type 50C5.
<b>25C6G</b>	Refer to chart at end of section.
<b>25CA5</b>	Refer to type 6CA5.
<b>25CD6GA</b>	Refer to chart at end of section.
<b>25CD6GB</b>	Refer to type 6CD6GA.

Refer to type 6BQ6GTB/6CU6.

25CU6



5BT

BEAM POWER TUBE

25DN6

Glass octal type used as horizontal-deflection amplifier in television receivers. Outlines section, 21; requires octal socket. Vertical tube mounting is preferred but horizontal operation is permissible if pins 1 and 3 are in vertical plane.

Heater Voltage (ac/dc)	25	volts
Heater Current	0.6	ampere
Heater Warm-up Time (Average)	11	seconds
Heater-Cathode Voltage:		
Peak value	±200 max	volts
Average value	100 max	volts

Class A<sub>1</sub> Amplifier

CHARACTERISTICS

Plate Voltage	50	125	volts
Grid-No.2 (Screen-Grid) Voltage	100	125	volts
Grid-No.1 (Control-Grid) Voltage	0	-18	volts
Mu Factor, Grid-No.2 to Grid No.1	—	4.35	
Plate Resistance	—	4000	ohms
Transconductance	—	9000	μmhos
Plate Current	240*	70	mA
Grid-No.2 Current	30*	6.3	mA
Grid-No.1 Voltage (Approx.) for plate current of .0.5 mA	—	-36	volts

\* These values can be measured by a method involving a recurrent waveform such that the maximum ratings of the tube will not be exceeded.

Horizontal-Deflection Amplifier

For operation in a 525-line, 30-frame system

MAXIMUM RATINGS (Design-Center Values)

DC Plate Voltage	700	volts
Peak Positive-Pulse Plate Voltage <sup>#</sup> (Absolute Maximum)	6600 <sup>□</sup>	volts
Peak Negative-Pulse Plate Voltage	-1500	volts
DC Grid-No.2 (Screen-Grid) Voltage	175	volts
Peak Negative-Pulse Grid-No.1 (Control-Grid) Voltage	-200	volts
Peak Cathode Current	700	mA
Average Cathode Current	200	mA
Plate Dissipation <sup>†</sup>	16	watts
Grid-No.2 Input	3	watts
Bulb Temperature (At hottest point)	225	°C

MAXIMUM CIRCUIT VALUE

Grid-No.1-Circuit Resistance	0.47	megohm
------------------------------	------	--------

<sup>#</sup> Pulse duration must not exceed 15% of a horizontal scanning cycle (10 microseconds).

<sup>□</sup> Under no circumstances should this absolute value be exceeded.

<sup>†</sup> A bias resistor or other means is required to protect the tube in absence of excitation.

Refer to chart at end of section.

25EC6

Refer to type 6EH5.

25EH5



7CV

BEAM POWER TUBE

25F5A

Miniature type used in audio-output stage of ac/dc radio receivers employing series-connected heater strings. Outlines section, 5D; requires miniature 7-contact socket.

Heater Voltage (ac/dc)	25	volts
Heater Current	0.15	ampere

Heater Warm-up Time (Average) .....	17	seconds
Heater-Cathode Voltage:		
Peak value .....	±200 max	volts
Average value .....	100 max	volts
Direct Interelectrode Capacitances (Approx.):		
Grid No.1 to Plate .....	0.44	pF
Grid No.1 to Cathode, Heater, Grid No.2, and Grid No. 3 .....	12	pF
Plate to Cathode, Heater, Grid No.2, and Grid No.3 .....	8	pF

**Class A<sub>1</sub> Amplifier****MAXIMUM RATINGS (Design-Maximum Values)**

Plate Voltage .....	150	volts
Grid-No.2 (Screen-Grid) Voltage .....	130	volts
Grid-No.1 (Control-Grid) Voltage, Positive-bias value .....	0	volts
Plate Dissipation .....	5.5	watts
Grid-No.2 Input .....	1.1	watts
Bulb Temperature (at hottest point) .....	220	°C

**TYPICAL OPERATION AND CHARACTERISTICS**

Plate Voltage .....	110	volts
Grid-No.2 Voltage .....	110	volts
Grid-No.1 Voltage .....	-7.5	volts
Peak AF Grid-No.1 Voltage .....	-7.5	volts
Plate Resistance (Approx.) .....	12000	ohms
Transconductance .....	6400	μmhos
Zero-Signal Plate Current .....	43	mA
Maximum-Signal Plate Current .....	45	mA
Zero-Signal Grid-No.2 Current .....	3.8	mA
Maximum-Signal Grid-No.2 Current .....	7.3	mA
Effective Load Resistance .....	2500	ohms
Total Harmonic Distortion .....	7	per cent
Maximum-Signal Power Output .....	1.5	watts

**MAXIMUM CIRCUIT VALUES**

Grid-No.1-Circuit Resistance:		
For fixed-bias operation .....	0.1	megohm
For cathode-bias operation .....	0.5	megohm

**Push-Pull Class AB<sub>1</sub> Amplifier****MAXIMUM RATINGS (Same as for class AB<sub>1</sub> amplifier)****TYPICAL OPERATION (Values are for two tubes)**

Plate Voltage .....	110	volts
Grid-No.2 Voltage .....	110	volts
Grid-No.1 Voltage .....	-8	volts
Peak AF Grid-No.1-to-Grid-No.1 Voltage .....	14.4	volts
Zero-Signal Plate Current .....	82	mA
Maximum-Signal Plate Current .....	88	mA
Zero-Signal Grid-No.2 Current .....	7.2	mA
Maximum-Signal Grid-No.2 Current .....	12.5	mA
Effective Load Resistance (Plate-to-plate) .....	4500	ohms
Total Harmonic Distortion .....	2.6	per cent
Maximum-Signal Power Output .....	2.9	watts

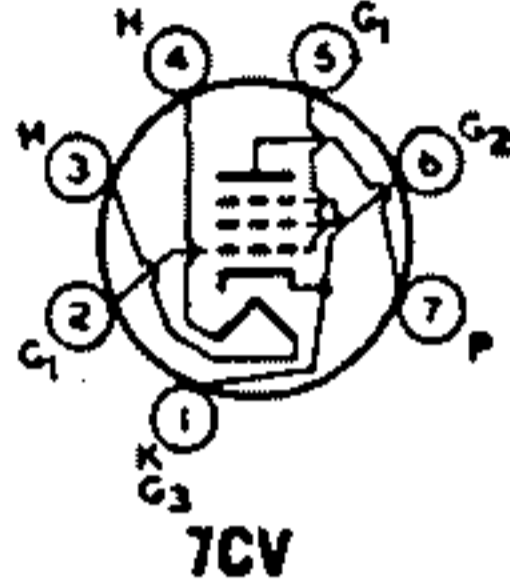
**MAXIMUM CIRCUIT VALUES**

Grid-No.1-Circuit Resistance:		
For fixed-bias operation .....	0.1	megohm
For cathode-bias operation .....	0.5	megohm

<b>25L6</b>	Refer to chart at end of section.
<b>25L6GT</b>	Refer to chart at end of section.
<b>25N6G</b>	Refer to chart at end of section.
<b>25W4GT</b>	Refer to chart at end of section.
<b>25Y5</b>	Refer to chart at end of section.
<b>25Z5</b>	Refer to chart at end of section.
<b>25Z6</b>	
<b>25Z6GT</b>	Refer to chart at end of section.
<b>26</b>	Refer to chart at end of section.
<b>27</b>	Refer to chart at end of section.
<b>27GB5/PL500</b>	Refer to type 6GB5.



Refer to chart at end of section. **30**  
 Refer to chart at end of section. **31**  
 Refer to type 6JS6. **31JS6A**  
 Refer to chart at end of section. **32**  
 Refer to chart at end of section. **32ET5**



**POWER PENTODE 32ET5A**

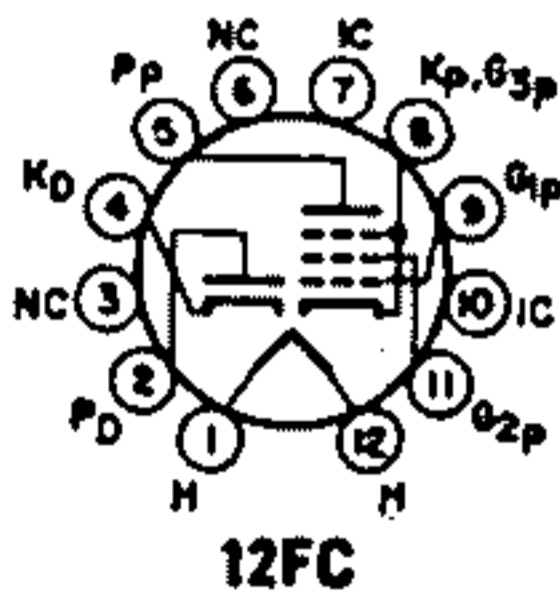
Miniature type used in audio output stage of compact ac/dc radio receivers, Outlines section, 5D; requires miniature 7-contact socket. Heater: volts (ac/dc), 32; amperes, 0.1; warm-up time (average), 20 seconds; maximum heater-cathode volts,  $\pm 200$  peak, 100 average.

**Class A<sub>1</sub> Amplifier**

<b>MAXIMUM RATINGS (Design-Maximum Values)</b>		
Plate Voltage .....	150	volts
Grid-No.2 (Screen-Grid) Voltage .....	130	volts
Plate Dissipation .....	5.4	watts
Grid-No.2 Input .....	1.2	watts
<b>TYPICAL OPERATION AND CHARACTERISTICS</b>		
Plate Voltage .....	110	volts
Grid-No.2 Voltage .....	110	volts
Grid-No.1 (Control-Grid) Voltage .....	-7.5	volts
Peak AP Grid-No.1 Voltage .....	7.5	volts
Zero-Signal Plate Current .....	30	mA
Zero-Signal Grid-No.2 Current .....	2.8	mA
Plate Resistance (Approx.) .....	21500	ohms
Transconductance .....	5500	$\mu$ mhos
Load Resistance .....	2800	ohms
Total Harmonic Distortion .....	10	per cent
Maximum-Signal Power Output .....	1.2	watts
<b>MAXIMUM CIRCUIT VALUES</b>		
Grid-No.1-Circuit Resistance:		
For fixed-bias operation .....	0.5	megohm
For cathode-bias operation .....	0.1	megohm

Refer to chart at end of section. **32L7GT**  
 Refer to chart at end of section. **33**

**DIODE—BEAM POWER TUBE 33GT7**



Duodecar type used in television receiver applications. The diode unit is used for damper service and the beam power unit for horizontal-deflection amplifier service. Outlines section, 15A; requires duodecar 12-contact socket. Heater: volts (ac/dc), 33.6; amperes, 0.45; warm-up time, 11 seconds; maximum heater-cathode volts,  $\pm 200$  peak, 100 average.

**Beam Power Unit as Class A<sub>1</sub> Amplifier**

CHARACTERISTICS	Pentode Connection			Triode† Connection	
	3500	60	130	130	
Plate Voltage .....	130	130	130	130	volts
Grid-No.2 (Screen-Grid) Voltage .....	—	0	-22.5	-22.5	volts
Grid-No.1 (Control-Grid) Voltage .....	—	—	—	4	volts
Amplification Factor .....	—	—	10000	—	ohms
Plate Resistance (Approx.) .....	—	—	6500	—	$\mu$ mhos
Transconductance .....	—	320	48	—	mA
Plate Current .....	—	22	2.9	—	mA
Grid-No.2 Current .....	—	—	—	—	volts
Grid-No.1 Voltage (Approx.) for plate current of 1 mA .....	-60	—	-40	—	

† Grid No.2 tied to plate.

**Beam Power Unit as Horizontal-Deflection Amplifier**

For operation in a 525-line, 30-frame system

MAXIMUM RATINGS (Design-Maximum Ratings)		
Plate Voltage	400	volts
Peak Positive-Pulse Plate Voltage <sup>#</sup>	8500	volts
Peak Negative-Pulse Plate Voltage	0	volts
Grid-No.2 Voltage	150	volts
DC Grid-No.1 DC Voltage, Negative-bias value	-55	volts
Peak Negative-Pulse Grid-No.1 Voltage	-330	volts
Average Cathode Current	140	mA
Peak Cathode Current	490	mA
Plate Dissipation <sup>*</sup>	9	watts
Grid-No.1 Input	2.5	watts

**MAXIMUM CIRCUIT VALUE**

Grid-No.1-Circuit Resistance	1	megohm
------------------------------	---	--------

\* A bias resistor or other means is required to protect the tube in absence of excitation.

**Damper Service—Diode Unit**

For operation in a 525-line, 30-frame system

MAXIMUM RATINGS (Design-Maximum Values)			
Peak Inverse Plate Voltage <sup>#</sup>	2500	volts	
Peak Plate Current	750	mA	
Average Plate Current	125	mA	
Plate Dissipation	3.5	watts	
Heater-Cathode Voltage:			
Peak value	+200	-2500	volts
Average value	+100	-400	volts
Bulb Temperature (at hottest point)	320		°C

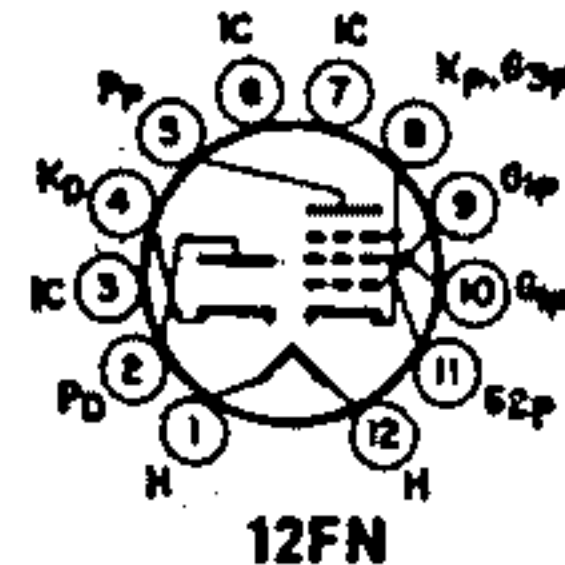
**CHARACTERISTICS, Instantaneous Value**

Tube Voltage Drop for plate current of 250 mA	21	volts
---	----	-------

<sup>#</sup> Pulse duration must not exceed 15% of a horizontal scanning cycle (10 microseconds).

**33GY7 DIODE—BEAM POWER TUBE**

Duodecar type used as combined damper diode and horizontal-deflection amplifier in television receivers. Outlines section, 15A; requires duodecar 12-contact socket. Heater: volts (ac/dc), 33.6; amperes, 0.45; warm-up time (average), 11 seconds.



**Beam Power Unit as Class A<sub>1</sub> Amplifier**

CHARACTERISTICS	Pentode Connection			Triode <sup>*</sup> Connection	
	5000	60	130	130	
Plate Voltage	5000	60	130	130	volts
Grid-No.2 (Screen-Grid) Voltage	130	130	130	130	volts
Grid-No.1 (Control-Grid) Voltage	—	0	-22.5	-22.5	volts
Amplification Factor	—	—	—	4	
Plate Resistance (Approx.)	—	—	10000	—	ohms
Transconductance	—	—	6500	—	ambos
Plate Current	—	320*	48	—	mA
Grid-No.2 Current	—	22*	2.9	—	mA
Grid-No.1 Voltage (Approx.) for plate current of 1 mA	-80	—	-40	—	volts

\* Grid No.2 tied to plate.

\* This value can be measured by a method involving a recurrent waveform such that the maximum ratings of the tube will not be exceeded.

**Beam Power Unit as Horizontal-Deflection Amplifier**

For operation in a 525-line, 30-frame system

MAXIMUM RATINGS (Design-Maximum Values)		
DC Plate Supply Voltage	400	volts
Peak Positive-Pulse Plate Voltage <sup>#</sup>	5000	volts
Peak Negative-Pulse Plate Voltage	0	volts
DC Grid-No.2 Voltage	150	volts
DC Grid-No.1 Voltage	-55	volts
Peak Negative-Pulse Grid-No.1 Voltage	-330	volts
Peak Cathode Current	540	mA
Average Cathode Current	155	mA
Plate Dissipation <sup>†</sup>	9	watts

Grid-No.2 Input .....	3	watts
Heater-Cathode Voltage:		
Peak value .....	±200	volts
Average value .....	100	volts

**MAXIMUM CIRCUIT VALUE**

Grid-No.1-Circuit Resistance .....	1	megohm
------------------------------------	---	--------

# Pulse duration must not exceed 15% of a horizontal scanning cycle (10 microseconds).

† A bias resistor or other means is required to protect the tube in absence of excitation.

**Damper Service (Diode Unit)**

For operation in a 525-line, 30-frame system

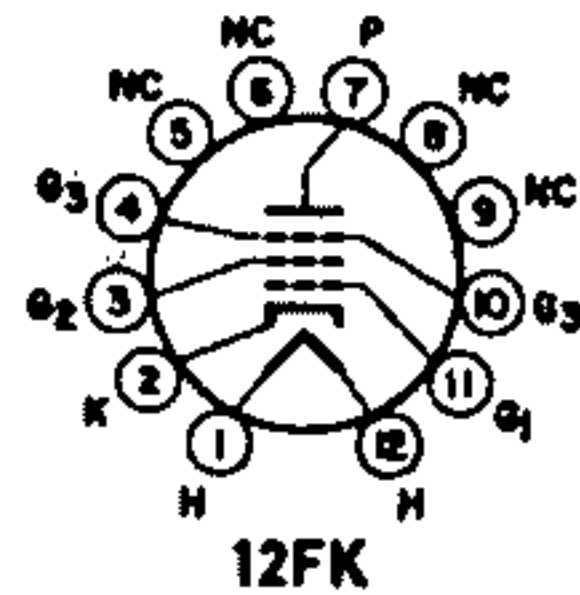
**MAXIMUM RATINGS (Design-Maximum Values)**

Peak Inverse Plate Voltage# .....	4200	volts	
Peak Plate Current .....	810	mA	
Average Plate Current .....	135	mA	
Plate Dissipation .....	3.8	watts	
Heater-Cathode Voltage:			
Peak value .....	+200	-4200	volts
Average value .....	+100	-400	volts
Bulb Temperature (At hottest point) .....	200	°C	

**CHARACTERISTICS, Instantaneous Value**

Tube Voltage Drop for plate current of 250 mA .....	21	volts
---	----	-------

# Pulse duration must not exceed 15% of a horizontal scanning cycle (10 microseconds).



**BEAM POWER TUBE**

**33JV6**  
21JV6

Duodecar type used as horizontal-deflection amplifier in television receivers. Outlines section, 15B; requires duodecar 12-contact socket. Type 21JV6 is identical with type 83JV6 except for heater ratings.

Heater Voltage: (ac/dc) .....	21	33	volts
Heater Current .....	0.45	0.3	ampere
Heater Warm-up Time (Average) .....	11	11	seconds
Heater-Cathode Voltage:			
Peak value .....	±200 max	±200 max	volts
Average value .....	100 max	100 max	volts

**Class A<sub>1</sub> Amplifier**

**CHARACTERISTICS**

	Triode* Connection		Pentode Connection		
	130	5000	60	120	
Plate Voltage .....	130	5000	60	120	volts
Grid No.3 (Suppressor Grid) .....	Connected to cathode at socket.				
Grid-No.2 (Screen-Grid) Voltage .....	130	130	130	130	volts
Grid-No.1 (Control-Grid) Voltage .....	-20	—	0	-20	volts
Plate Resistance (Approx.) .....	—	—	—	11000	ohms
Transconductance .....	—	—	—	9100	μmhos
Plate Current .....	—	—	410	50	mA
Grid-No.1 Current .....	—	—	24	1.75	mA
Grid-No.1 Voltage (Approx.) for plate current of 1 mA .....	—	-66	—	-83	volts
Amplification Factor .....	4.7	—	—	—	

\* Grid No.2 tied to plate.

**Horizontal-Deflection Amplifier**

For operation in a 525-line, 30-frame system

**MAXIMUM RATINGS (Design-Maximum Values)**

DC Plate Supply Voltage .....	770	volts
Peak Positive-Pulse Plate Voltage# .....	6000	volts
Peak Negative-Pulse Plate Voltage .....	-1500	volts
DC Grid-No.3 Voltage .....	70	volts
DC Grid-No.2 Voltage .....	220	volts
DC Grid-No.1 Voltage, Negative-bias value .....	-55	volts
Peak Negative-Pulse Grid-No.1 Voltage .....	-350	volts
Average Cathode Current .....	230	mA
Peak Cathode Current .....	800	mA
Plate Dissipation** .....	18	watts
Grid-No.2 Input .....	3.5	watts
Bulb Temperature (At hottest point) .....	220	°C



**MAXIMUM CIRCUIT VALUE**

Grid-No.1-Circuit Resistance ..... 1 megohm

# Pulse duration must not exceed 16% of a horizontal scanning cycle (10 microseconds).

\*\* A bias resistor or other means is required to protect the tube in absence of excitation.

**34**

Refer to chart at end of section.

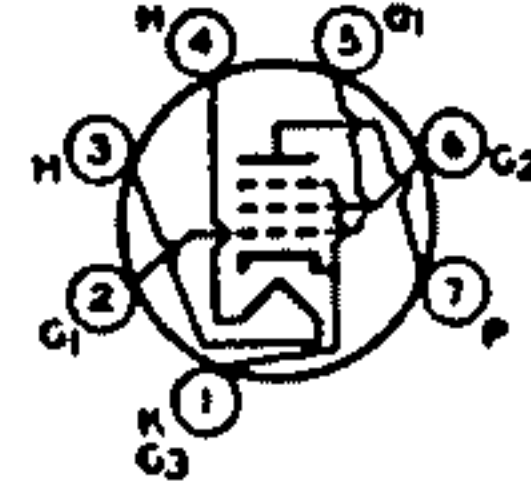
**34GD5**

Refer to chart at end of section.

**34GD5A**

**BEAM POWER TUBE**

Miniature type used in audio output stages of compact ac/dc radio receivers. Outlines section, 5D; requires miniature 7-contact socket. Heater: volts (ac/dc), 34; amperes 0.1; warm-up time, 20 seconds; maximum heater-cathode volts,  $\pm 200$  peak, 100 average.



7CV

**Class A<sub>1</sub> Amplifier**

**MAXIMUM RATINGS (Design-Maximum Values)**

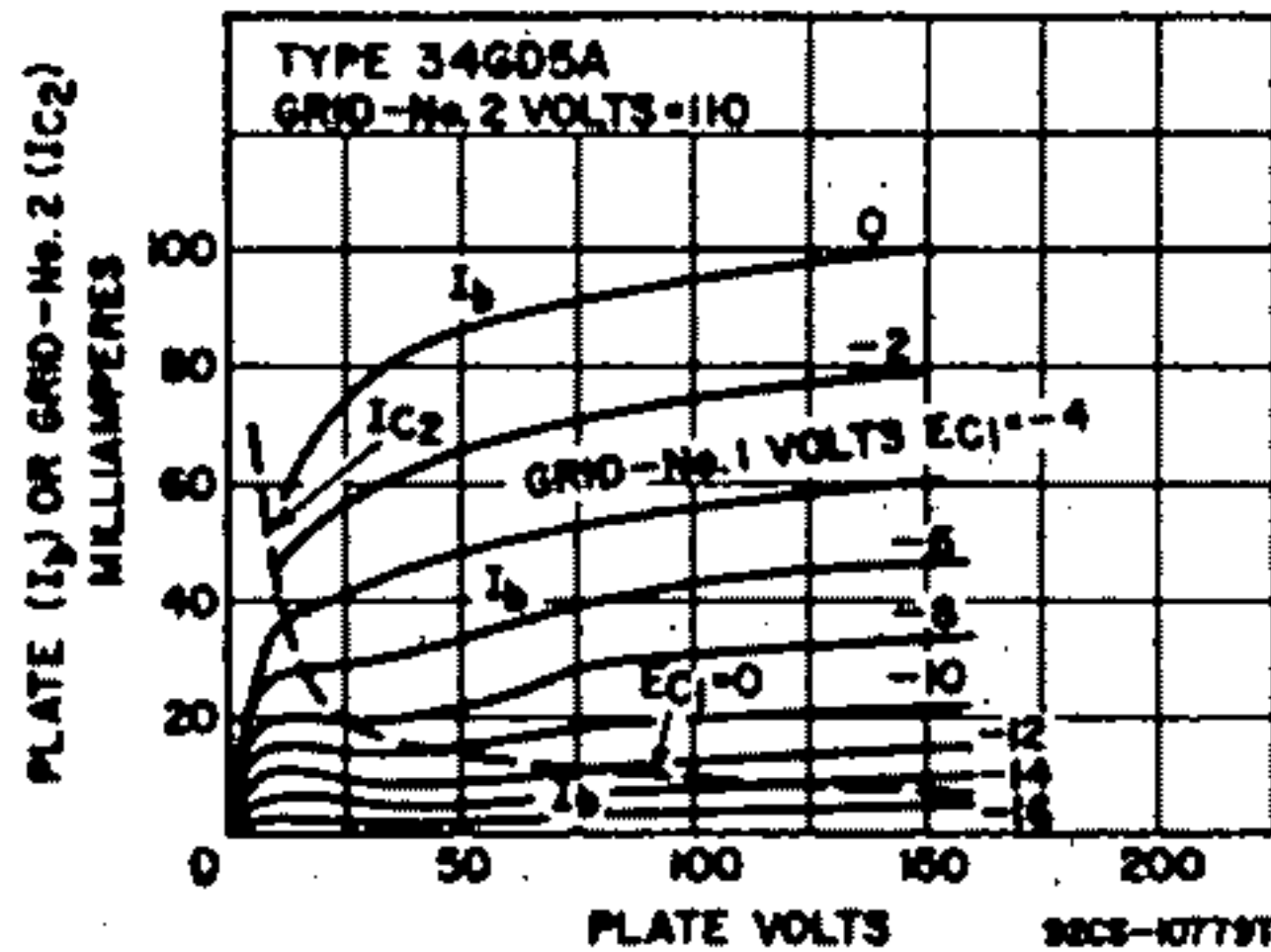
Plate Voltage	150	volts
Grid-No.2 (Screen-Grid) Voltage	130	volts
Grid-No.1 (Control-Grid) Voltage:		
Negative-bias value	-50	volts
Positive-bias value	0	volts
Plate Dissipation	5	watts
Grid-No.2 Input	1.1	watts
Bulb Temperature (At hottest point)	250	°C

**TYPICAL OPERATION AND CHARACTERISTICS**

Plate Voltage	110	volts
Grid-No.2 Voltage	110	volts
Grid-No.1 Voltage	-7.5	volts
Peak AF Grid-No.1 Voltage	7.5	volts
Zero-Signal Plate Current	35	mA
Zero-Signal Grid-No.2 Current	3	mA
Plate Resistance (Approx.)	13000	ohms
Transconductance	5700	$\mu$ mhos
Load Resistance	2500	ohms
Total Harmonic Distortion	10	per cent
Maximum-Signal Power Output	1.4	watts

**MAXIMUM CIRCUIT VALUES**

Grid-No.1-Circuit Resistance:		
For fixed-bias operation	0.1	megohm
For cathode-bias operation	0.5	megohm



**35**

Refer to chart at end of section.

**35A5**

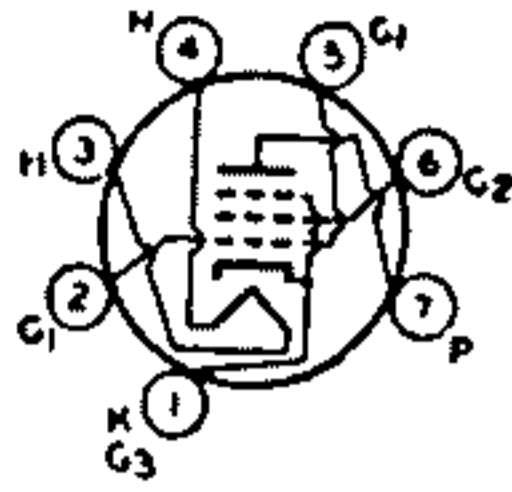
Refer to chart at end of section.

**35B5**

Refer to chart at end of section.

BEAM POWER TUBE

35C5



7CV

Miniature type used in output stage of compact, ac/dc radio receivers. Outlines section, 5D; requires miniature 7-contact socket. This tube, like other power-handling tubes, should be adequately ventilated. Except for terminal connections and slightly higher ratings, type 35C5 is equivalent in performance to miniature type 35B5 and, within its maximum ratings, to glass octal type 35L6GT.

Heater Voltage (ac/dc)	35	volts
Heater Current	0.16	ampere
Heater-Cathode Voltage:		
Peak value	±200 max	volts
Average value	100 max	volts
Direct Interelectrode Capacitances (Approx.):		
Grid No.1 to Plate	0.6	pF
Grid No.1 to Cathode, Heater, Grid No.2, and Grid No.3	12	pF
Plate to Cathode, Heater, Grid No.2, and Grid No.3	9	pF

Class A<sub>1</sub> Amplifier

MAXIMUM RATINGS (Design-Maximum Values)

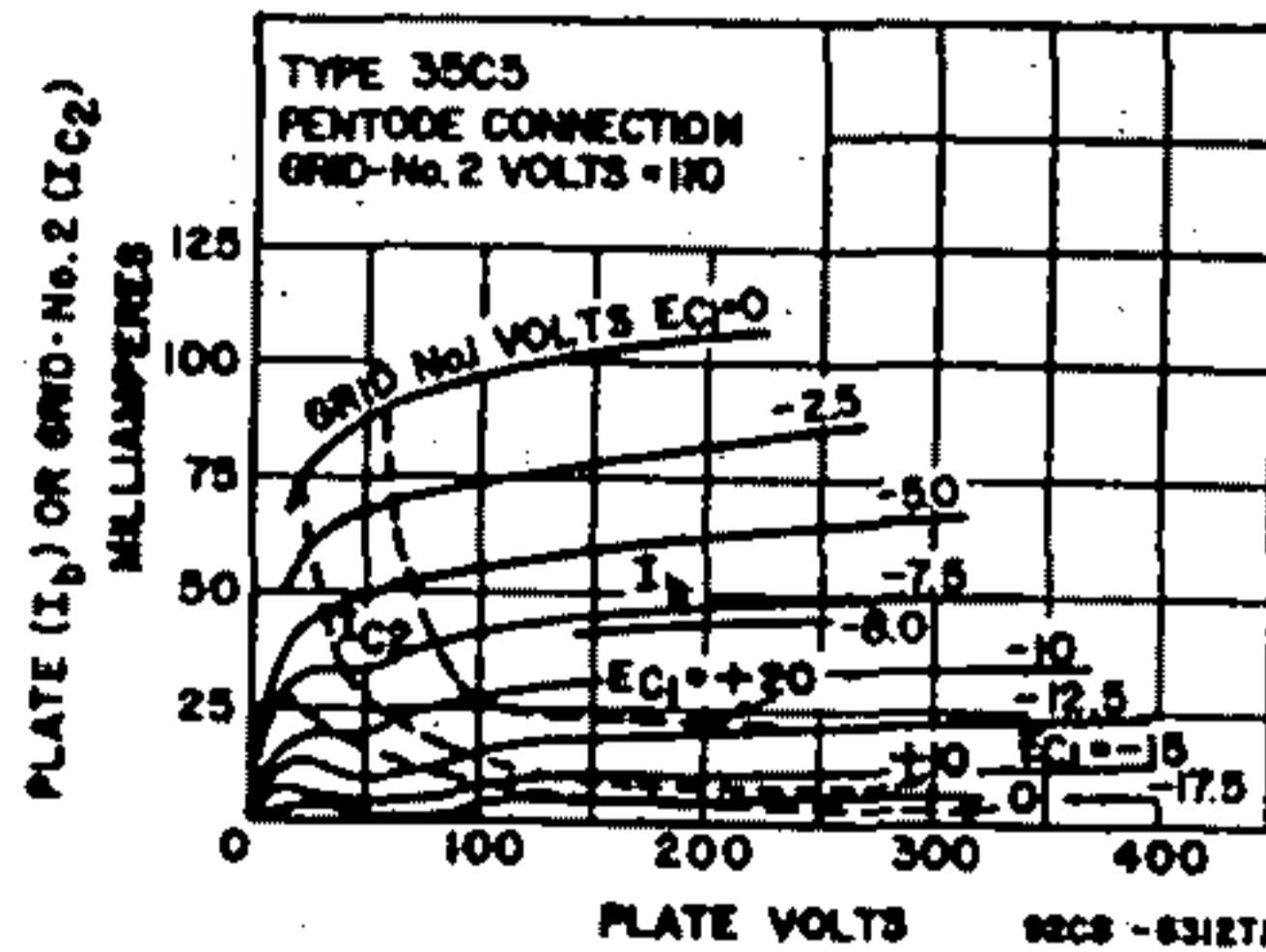
Plate Voltage	160	volts
Grid-No.2 (Screen-Grid) Voltage	180	volts
Plate Dissipation	6.2	watts
Grid-No.2 Input	1.1	watts
Bulb Temperature (At hottest point)	250	°C

TYPICAL OPERATION

Plate Voltage	110	volts
Grid-No.2 Voltage	110	volts
Grid-No.1 (Control-Grid) Voltage	-7.5	volts
Peak AF Grid-No.1 Voltage	7.5	volts
Zero-Signal Plate Current	40	mA
Maximum-Signal Plate Current	41	mA
Zero-Signal Grid-No.2 Current	8	mA
Maximum-Signal Grid-No.2 Current	7	mA
Plate Resistance (Approx.)	18000	ohms
Transconductance	5800	μmhos
Load Resistance	2500	ohms
Total Harmonic Distortion	10	per cent
Maximum-Signal Power Output	1.5	watts

MAXIMUM CIRCUIT VALUES

Grid-No.1-Circuit Resistance:		
For fixed-bias operation	0.1	megohm
For cathode-bias operation	0.5	megohm



**Installation and Application**

The 35-volt heater is designed to operate under the normal conditions of line-voltage variation without materially affecting the performance or serviceability of the 35C5. For operation of the 35C5 in series with other types having 0.15-ampere rating, the current in the heater circuit should be adjusted to 0.15 ampere for the normal supply voltage.

In a series-heater circuit of the "dc-power line" type employing several 0.15-ampere types and one or two 35C5s, the heater(s) of the 35C5(s) should be placed on the positive side of the line. Under these conditions, heater-cathode voltage of the 35C5 must not exceed the value given under maximum ratings. In a series-heater circuit of the "universal" type employing rectifier tube 35W4, one or two 35C5s and several 0.15-ampere types, it is recommended that the heater(s) of the 35C5(s) be placed in the circuit so that the higher values of heater-cathode bias will be impressed on the 35C5(s) rather than on the other 0.15-ampere types. This is accomplished by arranging the 35C5(s) on the side of the supply line which is connected to the cathode of the rectifier, i.e., the positive terminal of the rectified voltage supply. Between this side of the line and the 35C5(s), any necessary auxiliary resistance and the heater of the 35W4 are connected in series.

As a power amplifier (class A<sub>1</sub>), the 35C5 is recommended for use either singly or in push-pull combination in the power-output stage of ac/dc receivers. The operating values shown under typical operation have been determined on the basis that grid-No.1 current does not flow during any part of the input cycle.

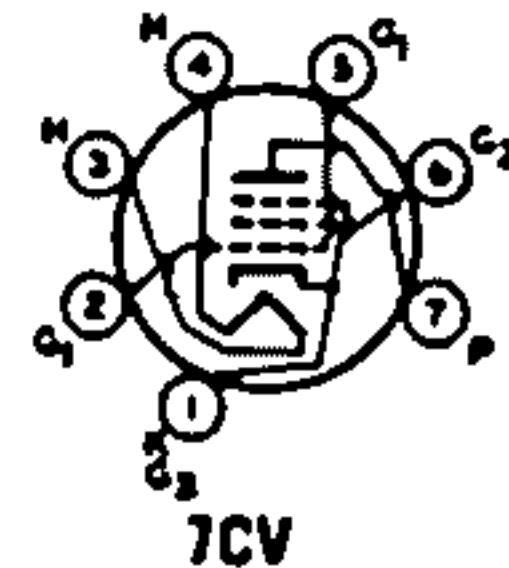
**35DZ8**

Refer to chart at end of section.

**35EH5**

**POWER PENTODE**

Miniature type used in the audio output stage of radio and television receivers and in phonographs. Outlines section, 5D; requires miniature 7-contact socket.



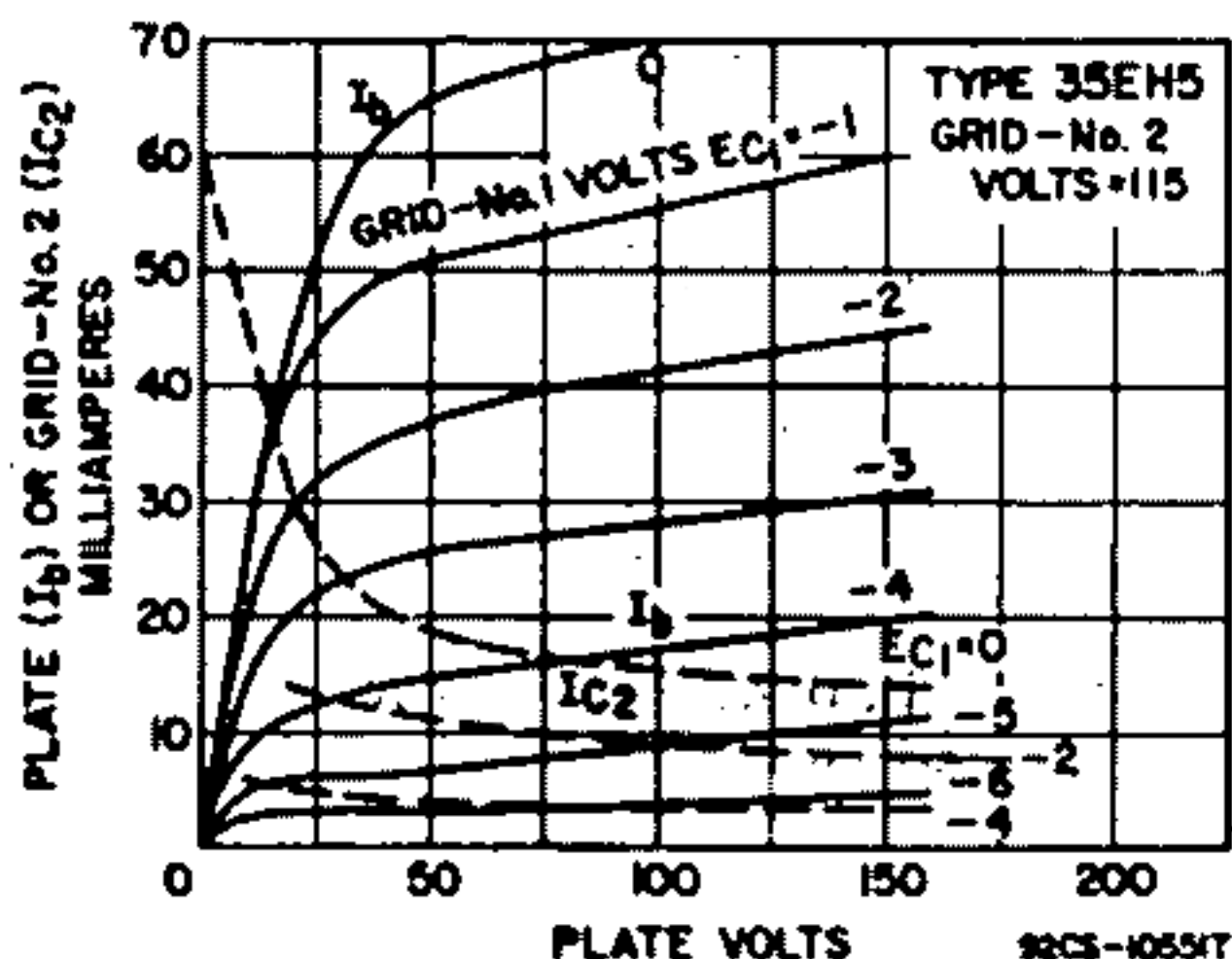
Heater Voltage (ac/dc) .....	35	volts
Heater Current .....	0.15	ampere
Heater-Cathode Voltage:		
Peak value .....	±200 max	volts
Average value .....	100 max	volts
Direct Interelectrode Capacitances (Approx.):		
Grid No.1 to Plate .....	0.65	pF
Grid No.1 to Cathode, Heater, Grid No.2, and Grid No.3 .....	17	pF
Plate to Cathode, Heater, Grid No.2, and Grid No.3 .....	9	pF

**Class A<sub>1</sub> Amplifier**

<b>MAXIMUM RATINGS (Design-Maximum Values)</b>		
Plate Voltage .....	150	volts
Grid-No.2 (Screen-Grid) Voltage .....	130	volts
Grid-No.1 (Control-Grid) Voltage, Positive-bias value .....	0	volts
Plate Dissipation .....	5	watts
Grid-No.2 Input .....	1.75	watts
Bulb Temperature (At hottest point) .....	225	°C
<b>TYPICAL OPERATION</b>		
Plate Supply Voltage .....	110	volts
Grid-No.2 Supply Voltage .....	115	volts
Cathode-Bias Resistor .....	62	ohms
Peak AF Grid-No.1 Voltage .....	3	volts
Zero-Signal Plate Current .....	32	mA
Maximum-Signal Plate Current .....	32	mA
Zero-Signal Grid-No.2 Current .....	7.2	mA
Maximum-Signal Grid-No.2 Current .....	12	mA

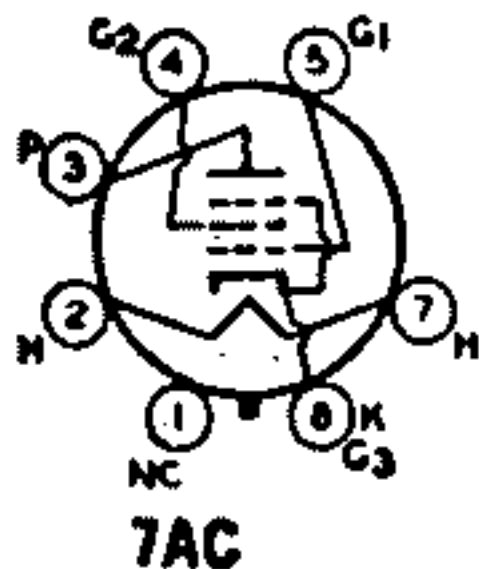


Plate Resistance (Approx.)	14000	ohms
Transconductance	5800	μmhos
Load Resistance	3000	ohms
Total Harmonic Distortion	10	per cent
Maximum-Signal Power Output	1.2	watts
<b>MAXIMUM CIRCUIT VALUES</b>		
Grid-No.1-Circuit Resistance:		
For fixed-bias operation	0.1	megohm
For cathode-bias operation	0.5	megohm



Refer to chart at end of section.

35GL6



BEAM POWER TUBE

35L6GT

Glass octal type used in output stage of ac/dc radio receivers. Outlines section, 13D; requires octal socket. This type may be supplied with pin No.1 omitted. Refer to miniature type 35C5 for installation, application information, and curves.

Heater Voltage (ac/dc)	35	volts
Heater Current	0.15	ampere
Peak Heater-Cathode Voltage	±90 max	volts
Direct Interelectrode Capacitances (Approx.):		
Grid No.1 to Plate	0.6	pF
Grid No.1 to Cathode, Heater, Grid No.2, and Grid No.3	18	pF
Plate to Cathode, Heater, Grid No.2, and Grid No.3	9.5	pF

Class A<sub>1</sub> Amplifier

<b>MAXIMUM RATINGS (Design-Center Value)</b>		
Plate Voltage	200	volts
Grid-No.2 (Screen-Grid) Voltage	125	volts
Plate Dissipation	8.5	watts
Grid-No.2 Input	1.0	watt

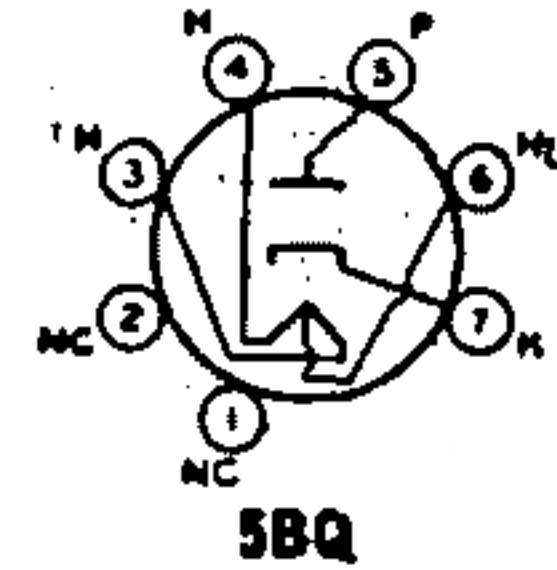
<b>TYPICAL OPERATION</b>			
Plate Supply Voltage	Fixed Bias 110	Cathode Bias 200	volts
Grid-No.2 Supply Voltage	110	125	volts
Grid-No.1 (Control-Grid) Voltage	-7.5	—	volts
Cathode-Bias Resistor	—	180	ohms
Peak AF Grid-No.1 Voltage	7.5	8	volts
Zero-Signal Plate Current	40	43	mA
Maximum-Signal Plate Current	41	43	mA
Zero-Signal Grid-No.2 Current	3	2	mA
Maximum-Signal Grid-No.2 Current	7	5.5	mA
Plate Resistance	14000	34000	ohms
Transconductance	5800	6100	μmhos
Load Resistance	2500	5000	ohms
Total Harmonic Distortion	10	10	per cent
Maximum-Signal Power Output	1.5	2.0	watts

<b>MAXIMUM CIRCUIT VALUES</b>		
Grid-No.1-Circuit Resistance:		
For fixed-bias operation	0.1	megohm
For cathode-bias operation	0.5	megohm

# 35W4

## HALF-WAVE VACUUM RECTIFIER

Miniature type used in power supply of ac/dc receivers. Outlines section, 5D; requires miniature 7-contact socket. This type is equivalent in performance to glass-octal type 35Z5GT. The heater is provided with a tap for operation of a panel lamp.



Heater Voltage (ac/dc):	*	**	
Entire Heater (pins 3 and 4)	35	32	volts
Panel Lamp Section (pins 4 and 6)	7.5	5.5	volts
Heater Current:			
Between Pins 3 and 4	0.15	—	ampere
Between Pins 3 and 6	—	0.15	ampere
Peak Heater-Cathode Voltage		±360 max	volts

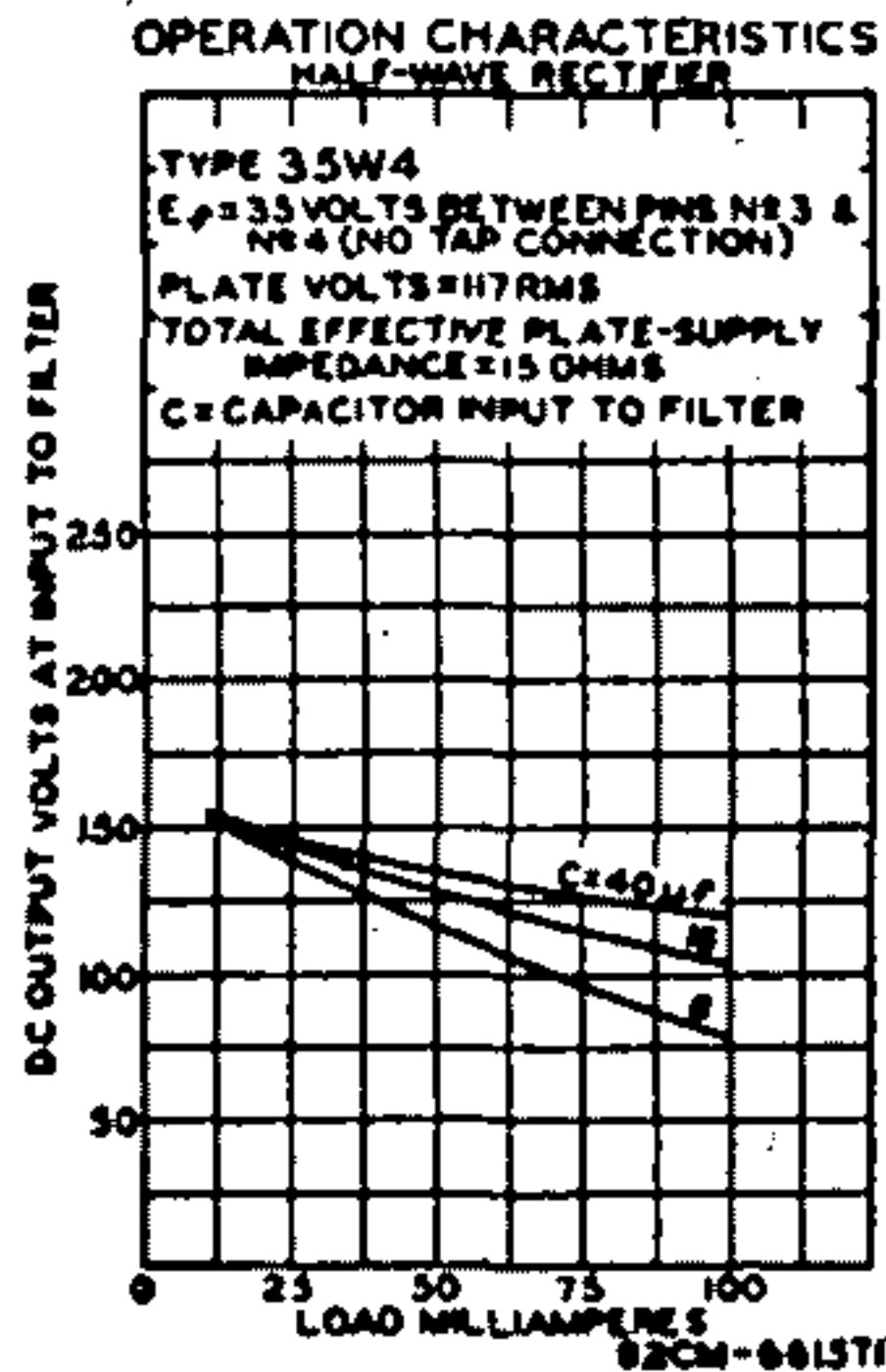
\* Without panel lamp.  
\*\* With No.40 or No.47 panel lamp.

### Half-Wave Rectifier

#### MAXIMUM RATINGS (Design-Maximum Values)

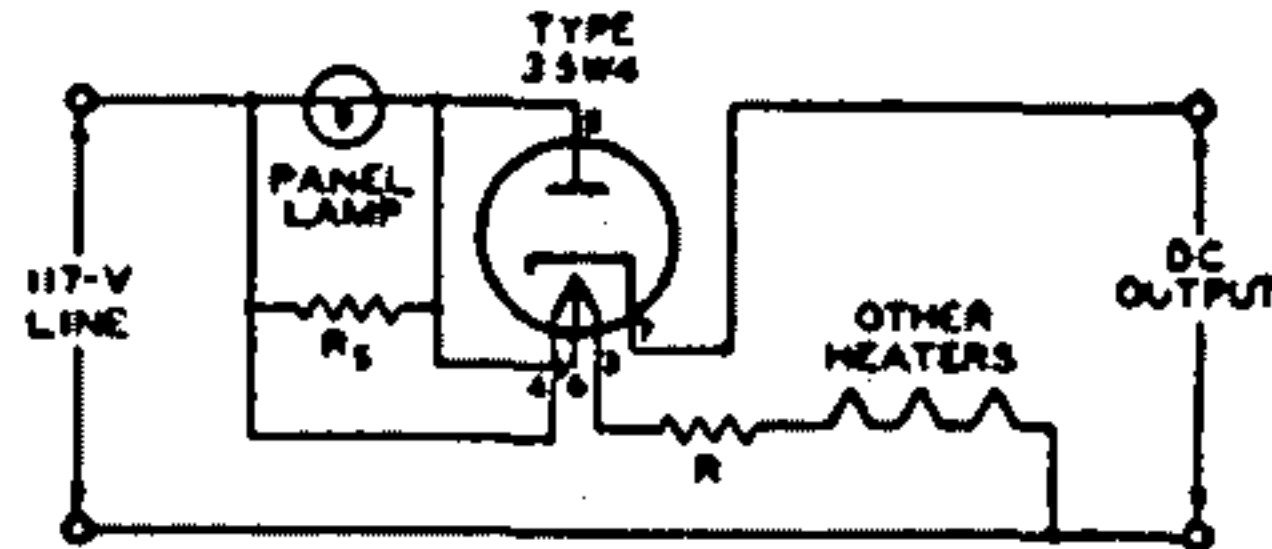
Peak Inverse Plate Voltage	360	volts
Peak Plate Current	660	mA
Average Output Current:		
With Panel Lamp and { No Shunting Resistor	66	mA
{ Shunting Resistor	100	mA
Without Panel Lamp	110	mA
Panel-Lamp-Section Voltage:		
When Panel Lamp Fails	17	volts

### Installation and Application



For heater considerations, refer to miniature type 35C5.

With the panel lamp connected as shown in the diagram, the drop across R and all heaters (with panel lamp) should equal 117 volts at 0.15 ampere. The shunting resistor R<sub>s</sub> is required when dc output current exceeds 60 milliamperes. Values of R<sub>s</sub> for dc output currents greater than 60 milliamperes are given in tabulated data.



AC Plate-Supply Voltage (rms)	117	117	117	117	volts
Filter-Input Capacitor	40	40	40	40	µF
Minimum Total Effective Plate-Supply Impedance	15	15	15	15	ohms
Panel-Lamp Shunting Resistor	—	300	150	100	ohms
Average Output Current	60	70	80	90	mA

† No.40 or No.47 panel lamp used in circuit given below with capacitor-input filter.

#### TYPICAL OPERATION WITHOUT PANEL LAMP

AC Plate-Supply Voltage (rms)	117	volts
Filter-Input Capacitor	40	µF
Minimum Total Effective Plate-Supply Impedance	15	ohms
Average Output Current	100	mA

DC Output Voltage at Input to Filter (Approx.):		
At half-load current (50 mA)	135	volts
At full-load current (100 mA)	120	volts
Voltage Regulation (Approx.):		
Half-load to full-load current	15	volts

**MAXIMUM CIRCUIT VALUES**

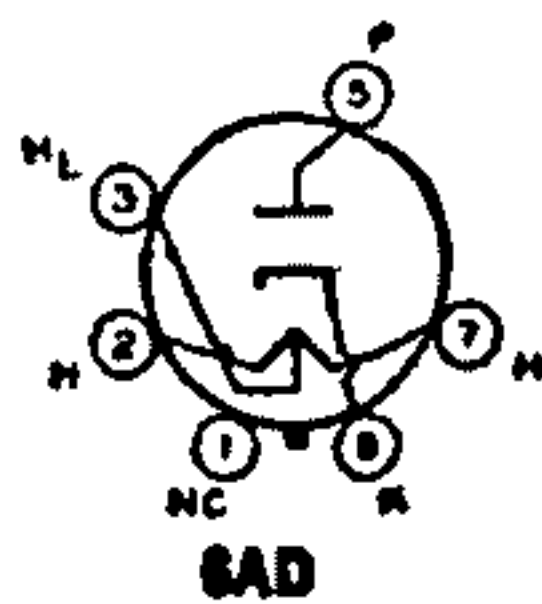
Panel-Lamp Shunting Resistor*:		
For dc output current of	70 mA	800 ohms
	80 mA	400 ohms
	90 mA	250 ohms

\* Required when dc output current is greater than 60 milliamperes.

Refer to chart at end of section. **35Y4**

Refer to chart at end of section. **35Z3**

Refer to chart at end of section. **35Z4GT**



**HALF-WAVE VACUUM RECTIFIER**

**35Z5GT**

Glass octal type used in power supply of ac/dc receivers. The heater is provided with a tap for operation of a panel lamp. Outlines section, 13D; requires octal socket. This type may be supplied with pin No.1 omitted. For installation and application considerations, refer to miniature type 35W4.

Heater Voltage (ac/dc):		
Entire Heater (pins 2 and 7)	35	32 volts
Panel Lamp Section (pins 2 and 8)	7.5	5.5 volts
Heater Current:		
Between Pins 2 and 7	0.15	ampere
Between Pins 3 and 7	—	0.15 ampere
Peak Heater-Cathode Voltage	—	±350 max volts

\* Without panel lamp.

\*\* With No.40 or No.47 panel lamp.

**Half-Wave Rectifier**

**MAXIMUM RATINGS (Design-Center Values)**

Peak Inverse Plate Voltage	700	volts
Peak Plate Current	600	mA
Average Output Current:		
With Panel Lamp and	No Shunting Resistor	60 mA
Without Panel Lamp		
Panel-Lamp-Section Voltage (rms):	100	mA
When Panel Lamp Fails	15	volts

**TYPICAL OPERATION WITH PANEL LAMP†**

AC Plate-Supply Voltage (rms)	117	117	117	117	235	volts
Filter-Input Capacitor	40	40	40	40	40	μF
Minimum Total Effective Plate-Supply Impedance	15	15	15	15	100	ohms
Panel-Lamp Shunting Resistor	—	300	150	100	—	ohms
Average Output Current	60	70	80	90	60	mA

† No.40 or No.47 panel lamp used in circuit with capacitor-input filter given under type 35W4.

**TYPICAL OPERATION WITHOUT PANEL LAMP†**

AC Plate-Supply Voltage (rms)	117	235	volts
Filter-Input Capacitor	40	40	μF
Minimum Total Effective Plate-Supply Impedance	15	100	ohms
Average Output Current	100	100	mA
DC Output Voltage at Input to Filter (Approx.):			
At half-load current (50 mA)	140	230	volts
At full-load current (100 mA)	120	235	volts
Voltage Regulation (Approx.):			
Half-load to full-load current	20	45	volts

**MAXIMUM CIRCUIT VALUES**

Panel-Lamp Shunting Resistor*:		
For dc output current of	70 mA	300 ohms
	80 mA	400 ohms
	90 mA	250 ohms

\* Required when dc output current is greater than 60 milliamperes.



36

Refer to chart at end of section.

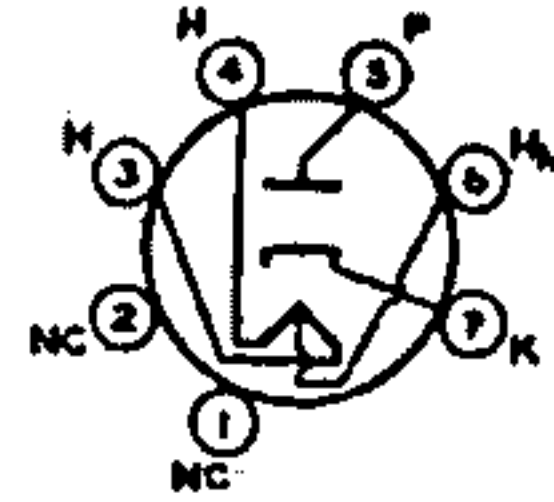
36AM3  
36AM3A

Refer to chart at end of section.

**36AM3B**

**HALF-WAVE  
VACUUM RECTIFIER**

Miniature type used in power supply of ac/dc receivers. This type has a tapped heater so that the heater section between pins 4 and 6 can be used as a limiting resistance in the rectifier plate circuit. This heater section is not to be used as a panel-lamp shunt. Outlines section, 5D; requires miniature 7-contact socket.



5BQ

Heater Voltage (ac/dc):			
Entire Heater (Pins 3 and 4)	36		volts
Tap Section (Pins 3 and 6)	32		volts
Heater Current (Pins 3 and 6)	0.1		ampere
Heater Warm-up Time (Average)	20		seconds
Heater-Cathode Voltage:			
Peak value	+200	-350 max	volts
Average value	+100	-350 max	volts

**Half-Wave Rectifier**

**MAXIMUM RATINGS (Design-Maximum Values)**

Peak Inverse Plate Voltage	365		volts
Peak Plate Current	580		mA
Average Output Current	82		mA

**TYPICAL OPERATION WITH CAPACITOR INPUT TO FILTER**

AC Plate-Supply Voltage (rms)	120	117		volts
Filter-Input Capacitor	40	40		$\mu F$
Total Effective Plate Supply Resistance			See text above	
Average Output Current	75	75		mA
DC Output Voltage	118	105		volts

**CHARACTERISTICS**

Tube Voltage Drop for plate current of 150 mA	16	20		volts
---	----	----	--	-------

37

Refer to chart at end of section.

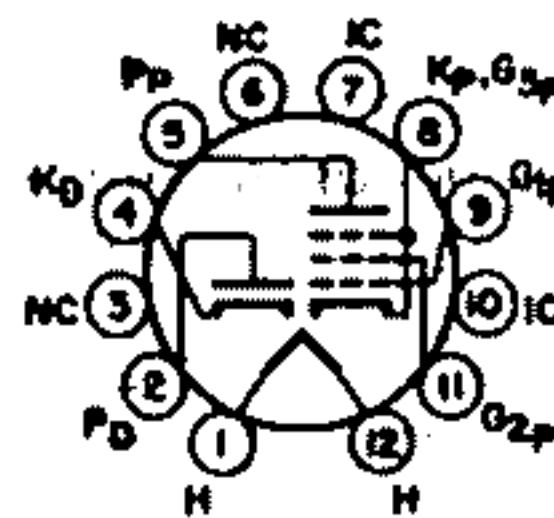
38

Refer to chart at end of section.

**38HE7**

**DIODE—BEAM POWER TUBE**

Duodecar type used in television receiver applications. The diode unit is used for damper service and the beam power unit for horizontal-deflection amplifier service. Outlines section, 15D; requires duodecar 12-contact socket. Heater: volts (ac/dc), 37.8; amperes, 0.45; warm-up time, 11 seconds; maximum heater-cathode volts,  $\pm 200$  peak, 100 average.



12FS

**Beam Power Unit As Class A<sub>1</sub> Amplifier**

CHARACTERISTICS	Pentode Connection			Triode** Connection	
	5000	50	130	130	
Plate Voltage	5000	50	130	130	volts
Grid-No.2 (Screen-Grid) Voltage	130	130	130	130	volts
Grid-No.1 (Control-Grid) Voltage	—	0	-22	-22	volts
Plate Resistance (Approx.)	—	—	6200	—	ohms
Transconductance	—	—	8800	—	$\mu mo$
Plate Current	—	450	60	—	mA
Grid-No.2 Current	—	40	2.8	—	mA
Grid-No.1 Voltage (Approx.) for plate current of 1 mA	-80	—	-30	—	volts
Amplification Factor	—	—	—	4.2	

\*\* Grid No.2 tied to plate.

**Beam Power Unit as Horizontal-Deflection Amplifier**

For operation in a 525-line, 30-frame system

**MAXIMUM RATINGS (Design-Maximum Ratings)**

Plate Voltage	500	volts
Peak Positive-Pulse Plate Voltage†	5000	volts
Peak Negative-Pulse Plate Voltage	0	volts
Grid-No.2 Voltage	150	volts
DC Grid-No.1 Voltage, Negative-bias value	55	volts
Peak Negative-Pulse Grid-No.1 Voltage	330	volts
Average Cathode Current	230	mA
Peak Cathode Current	800	mA
Plate Dissipation†	10	watts
Grid-No.2 Input	3.5	watts

**MAXIMUM CIRCUIT VALUE**

Grid-No.1-Circuit Resistance	1	megohm
------------------------------	---	--------

† A bias resistor or other means is required to protect the tube in absence of excitation.

**Damper Service—Diode Unit**

For operation in a 525-line, 30-frame system

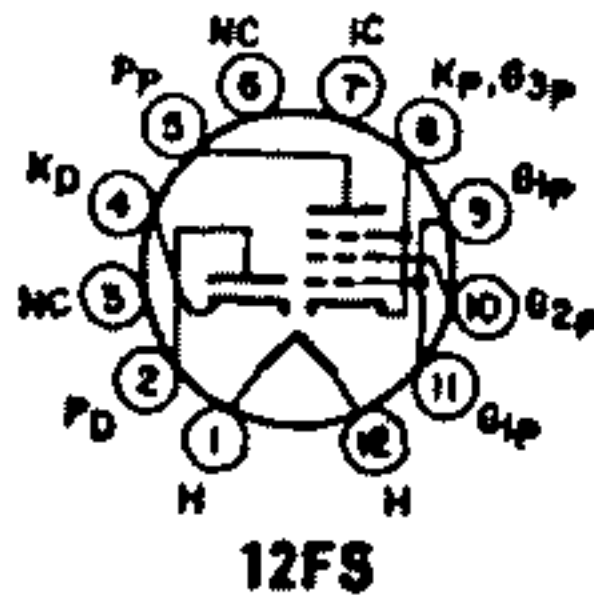
**MAXIMUM RATINGS (Design-Maximum Values)**

Peak Inverse Plate Voltage†	4200	volts
Peak Plate Current	1200	mA
Average Plate Current	200	mA
Heater-Cathode Voltage:		
Peak value	+200    -4200	volts
Average value	+100    -500	volts
Bulb Temperature (at hottest point)	200	°C

**CHARACTERISTICS, Instantaneous Value**

Tube Voltage Drop for plate current of 350 mA	21	volts
---	----	-------

‡ Pulse duration must not exceed 15% of a horizontal scanning cycle (10 microseconds).



**DIODE—BEAM POWER TUBE 38HK7**

Duodecar type used in television receiver applications. The diode unit is used for damper service and the beam power unit for horizontal-deflection amplifier service. Outlines section, 15D; requires duodecar 12-contact socket.

Heater Voltage (ac/dc)	37.8	volts
Heater Current	0.45	ampere
Heater Warm-up Time (Average)	11	seconds
Heater-Cathode Voltage:		
Peak value	±200 max	volts
Average value	100 max	volts
Direct Interelectrode Capacitances (Approx.):		
Diode Unit:		
Plate to Cathode and Heater	10	pF
Cathode to Plate and Heater	9	pF
Heater to Cathode	2	pF
Beam Power Unit:		
Grid No.1 to Plate	0.38	pF
Grid No.1 to Cathode, Heater, Grid No.2, and Grid No.3	19	pF
Plate to Cathode, Heater, Grid No.2, and Grid No.3	8	pF

**Beam Power Unit as Class A<sub>1</sub> Amplifier**

CHARACTERISTICS	Triode**		Pentode Connection		
	Connection				
Plate Voltage	130	3500	50	130	volts
Grid-No.2 (Screen-Grid) Voltage	130	130	130	130	volts
Grid-No.1 (Control-Grid) Voltage	-22	—	0	-22	volts
Amplification Factor	42	—	—	—	
Plate Resistance	—	—	—	6200	ohms
Transconductance	—	—	—	8800	umhos
Plate Current	—	—	450	60	mA
Grid-No.2 Current	—	—	40	2.8	mA
Grid-No.1 Voltage (Approx.) for plate current of 1 mA	—	-68	—	-59	volts

**MAXIMUM CIRCUIT VALUES**

Grid-No.1-Circuit Resistance	1.0	megohm
------------------------------	-----	--------

\*\* Grid No.2 tied to plate.

**Beam Power Unit as Horizontal-Deflection Amplifier**

For operation in a 525-line, 30-frame system

**MAXIMUM RATINGS (Design-Maximum Values)**

Plate Voltage .....	500	volts
Peak Positive-Pulse Plate Voltage .....	5000	volts
Peak Negative-Pulse Plate Voltage .....	0	volts
Grid-No.2 Voltage .....	150	volts
DC Grid-No.1 Voltage, Negative-bias value .....	-55	volts
Peak Negative-Pulse Grid-No.1 Voltage .....	-330	volts
Average Cathode Current .....	230	mA
Peak Cathode Current .....	800	mA
Plate Dissipation† .....	10	watts
Grid-No.2 Input .....	3.5	watts

**MAXIMUM CIRCUIT VALUE**

Grid-No.1-Circuit Resistance .....	1	megohm
------------------------------------	---	--------

† A bias resistor or other means is required to protect the tube in absence of excitation.

**Damper Service—Diode Unit**

For operation in a 525-line, 30-frame system

**MAXIMUM RATINGS (Design-Maximum Values)**

Peak Inverse Plate Voltage# .....	4200	volts	
Peak Plate Current .....	1200	mA	
Average Plate Current .....	200	mA	
Heater-Cathode Voltage:			
Peak value .....	+200	-3700	volts
Average value .....	+100	-500	volts
Bulb Temperature (At hottest point) .....	200	°C	

**CHARACTERISTICS, Instantaneous Value**

Tube Voltage Drop for plate current of 350 mA .....	16	volts
---	----	-------

# Pulse duration must not exceed 15% of a horizontal scanning cycle (10 microseconds).

**39/44**

Refer to chart at end of section.

**40**

Refer to chart at end of section.

**41**

Refer to chart at end of section.

**42**

Refer to chart at end of section.

**43**

Refer to chart at end of section.

**45**

Refer to chart at end of section.

**45Z3**

Refer to chart at end of section.

**45Z5GT**

Refer to chart at end of section.

**46**

Refer to chart at end of section.

**47**

Refer to chart at end of section.

**48**

Refer to chart at end of section.

**49**

Refer to chart at end of section.

**50**

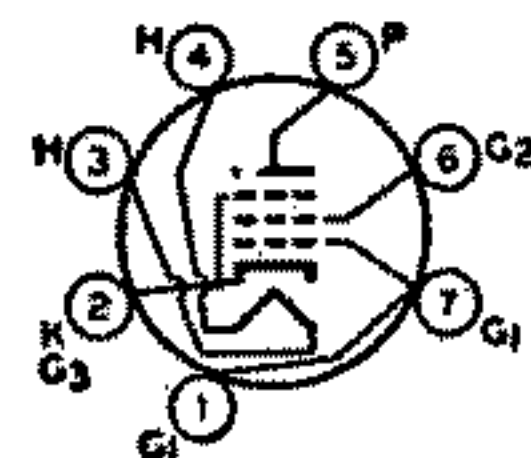
Refer to chart at end of section.

**50A5**

Refer to chart at end of section.

**50B5****BEAM POWER TUBE**

Miniature type used in output stage of compact ac/dc receivers. Outlines section, 5D; requires miniature 7-contact socket. Except for basing arrangement, type 50B5 is identical with miniature type 50C5.

**7BZ**



# 50C5

17C5, 25C5

## BEAM POWER TUBE



7CV

Miniature type used in output stage of compact, ac/dc radio receivers. Outlines section, 5D; requires miniature 7-contact socket. This tube, like other power-handling tubes, should be adequately ventilated. Within its maximum ratings, type 50C5 is equivalent in performance to glass octal type 50L6GT. Types 17C5 and 25C5 are identical with type 50C5 except for heater ratings.

	17C5	25C5	50C5	
Heater Voltage (ac/dc)	16.8	25	50	volts
Heater Current	0.45	0.3	0.15	ampere
Heater Warm-up Time (Average)	11	—	—	seconds
Heater-Cathode Voltage:				
Peak value	±200 max	±200 max	±200 max	volts
Average value	100 max	100 max	100 max	volts
Direct Interelectrode Capacitances (Approx.):				
Grid No.1 to Plate			0.6	pF
Grid No.1 to Cathode, Heater, Grid No.2, and Grid No.3			13	pF
Plate to Cathode, Heater, Grid No.2, and Grid No.3			8.6	pF

### Class A<sub>1</sub> Amplifier

#### MAXIMUM RATINGS (Design-Maximum Values)

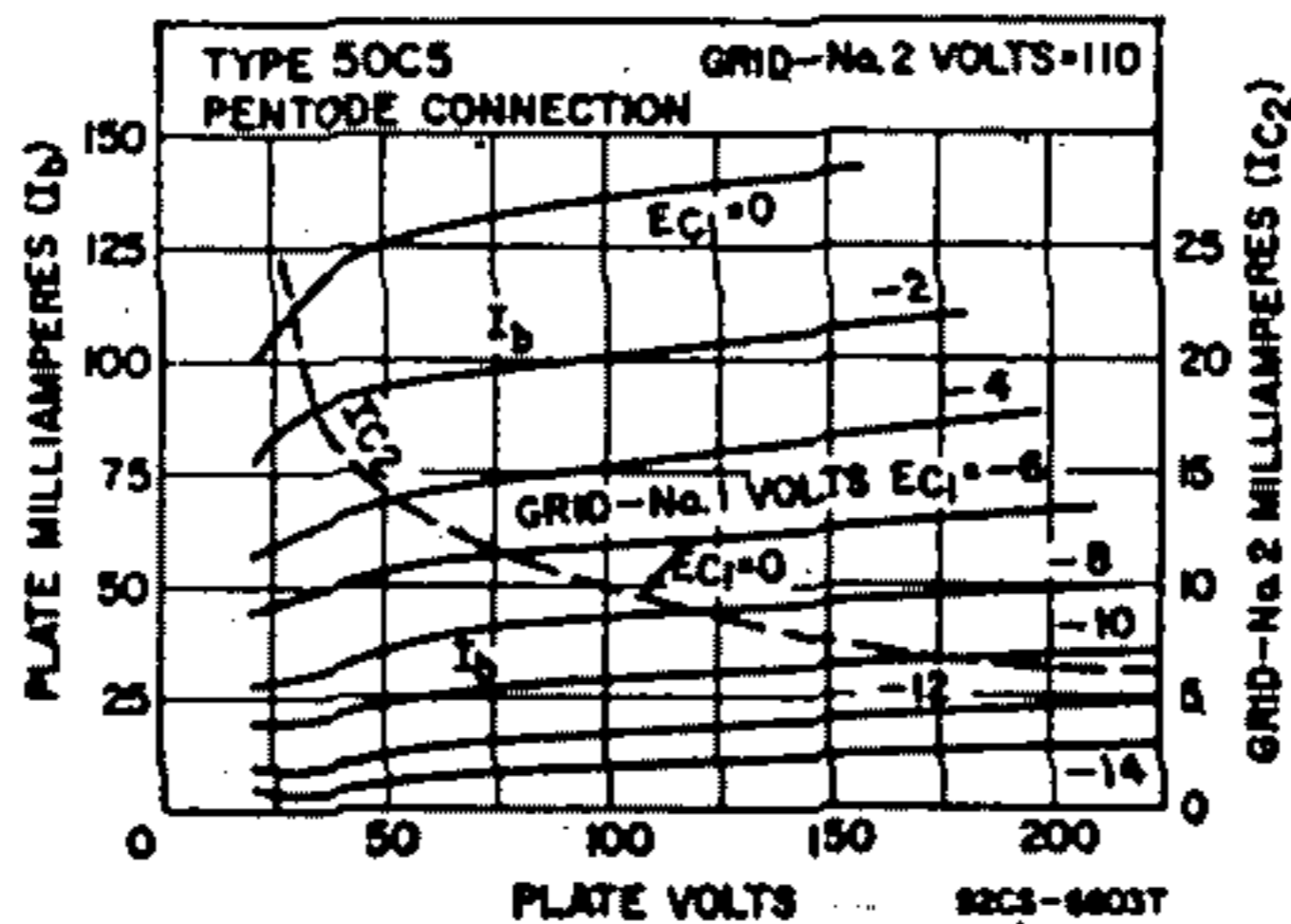
Plate Voltage	150	volts
Grid-No.2 (Screen-Grid) Voltage	130	volts
Grid-No.1 (Control-Grid) Voltage, Positive-bias value	0	volts
Plate Dissipation	7	watts
Grid-No.2 Input	1.4	watts
Bulb Temperature (At hottest point)	220	°C

#### TYPICAL OPERATION

Plate Voltage	120	volts
Grid-No.2 Voltage	110	volts
Grid-No.1 (Control-Grid) Voltage	-8	volts
Peak AF Grid-No.1 Voltage	8	volts
Zero-Signal Plate Current	49	mA
Maximum-Signal Plate Current	50	mA
Zero-Signal Grid-No.2 Current	4	mA
Maximum-Signal Grid-No.2 Current	8.5	mA
Plate Resistance (Approx.)	10000	ohms
Transconductance	7500	μmhos
Load Resistance	2500	ohms
Total Harmonic Distortion	10	per cent
Maximum-Signal Power Output	2.3	watts

#### MAXIMUM CIRCUIT VALUES

Grid-No.1-Circuit Resistance:		
For fixed-bias operation	0.1	megohm
For cathode-bias operation	0.5	megohm



**Installation and Application**

The 50-volt heater is designed to operate under the normal conditions of line voltage variation without materially affecting the performance or serviceability of the 50C5. For operation of the 50C5 in series with other types having 0.15-ampere rating, the current in the heater circuit should be adjusted to 0.15 ampere for the normal supply voltage.

In a series-heater circuit of the "dc power line" type employing several 0.15-ampere types and one or two 50C5s, the heater(s) of the 50C5(s) should be placed on the positive side of the line. Under these conditions, heater-cathode voltage of the 50C5 must not exceed the value given under maximum ratings. In a series-heater circuit of the "universal" type employing rectifier tube 35W4, one or two 50C5s, and several 0.15-ampere types, it is recommended that the heater(s) of the 50C5(s) be placed in the circuit so that the higher values of heater-cathode bias will be impressed on the 50C5(s) rather than on the other 0.15-ampere types. This is accomplished by arranging the 50C5(s) on the side of the supply line which is connected to the cathode of the rectifier, i.e., the positive terminal of the rectified voltage supply. Between this side of the line and the 50C5(s), any necessary auxiliary resistance and the heater of the 35W4 are connected in series.

As a power amplifier (class A<sub>1</sub>), the 50C5 is recommended for use either singly or in push-pull combination in the power-output stage of "ac/dc" receivers. The operating values shown under typical operation have been determined on the basis that grid-No. 1 current does not flow during any part of the input cycle.

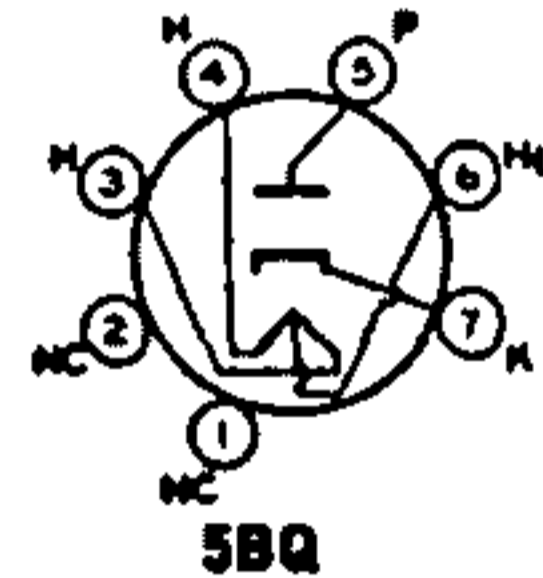
**50C6G**

Refer to chart at end of section.

**50DC4**

**HALF-WAVE  
VACUUM RECTIFIER**

Miniature type used in power supply of ac/dc radio receivers. The heater is provided with a tap for operation of a panel lamp. For typical circuit, refer to type 35W4. Outlines section, 5D; requires 7-contact socket.



Heater Voltage (ac/dc):	*	**	volts
Entire Heater (Pins 3 and 4) .....	50	45	volts
Panel-Lamp Section (Pins 4 and 6) .....	7.5	5.5	volts
Heater Current:			
Between Pins 3 and 4 .....	0.15	—	ampere
Between Pins 3 and 6 .....	—	0.15	ampere
Peak Heater-Cathode Voltage .....		±330 max	volts

\* Without panel lamp.  
\*\* With No.40 or No.47 panel lamp.

**Half-Wave Rectifier**

<b>MAXIMUM RATINGS (Design-Maximum Values)</b>				
Peak Inverse Plate Voltage .....			330	volts
Peak Plate Current .....			720	mA
Average Output Current:				
With Panel Lamp and { No Shunting Resistor .....			70	mA
{ Shunting Resistor .....			110	mA
Without Panel Lamp .....			120	mA
Panel-Lamp-Section Voltage (rms):				
When Panel Lamp Fails .....			16.5	volts
<b>TYPICAL OPERATION WITH PANEL LAMP†</b>				
AC Plate-Supply Voltage (rms) .....	117	117	117	117
Filter-Input Capacitor .....	40	40	40	μF
Minimum Total Effective Plate-Supply Impedance .....	15	15	15	ohms
Panel-Lamp Shunting Resistor .....	450	200	100	ohms
Average Output Current .....	70	90	90	100
<b>TYPICAL OPERATION WITHOUT PANEL LAMP</b>				
AC Plate-Supply Voltage (rms) .....			117	volts
Filter-Input Capacitor .....			40	μF

Minimum Total Effective Plate-Supply Impedance .....	15	ohms
Average Output Current .....	110	mA
DC Output Voltage at Input to Filter (Approx.):		
At half-load current (55 mA) .....	130	volts
At full-load current (110 mA) .....	110	volts
Voltage Regulation (Approx.):		
Half-load to full-load current .....	20	volts

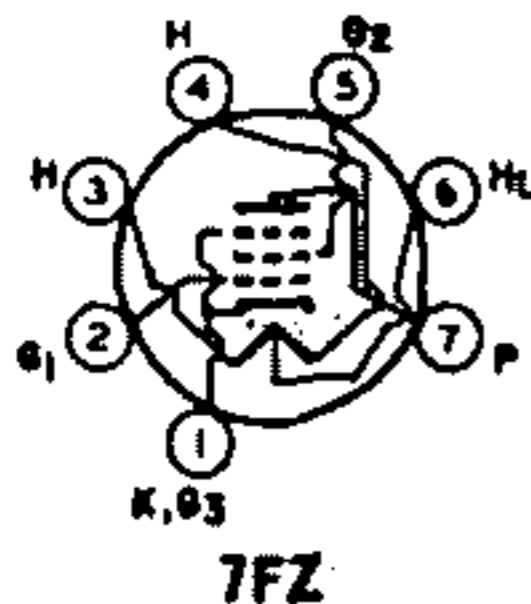
† No.40 or No.47 panel lamp used in circuit with capacitor-input filter given under type 85W4.  
 • Required when dc output current is greater than 70 milliamperes.

Refer to type 6EH5.  
 Refer to chart at end of section.  
 Refer to chart at end of section.

**50EH5**  
**50FE5**  
**50FK5**

**POWER PENTODE**

**50HC6**



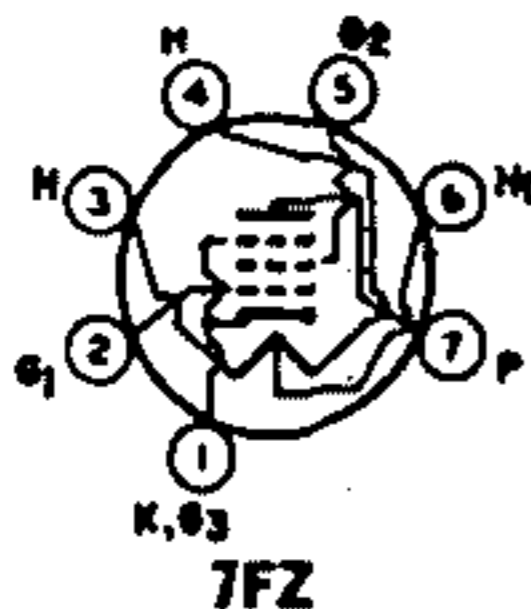
Miniature type used in the audio-frequency power-output stages of radio receivers. Heater is provided with a tap for operation of a panel lamp. Outlines section, 5D; requires miniature 7-contact socket. Heater: volts (ac/dc), 50; amperes, 0.15; tap volts (without panel lamp), 7; maximum heater-cathode volts, ±200 peak, 100 average.

**MAXIMUM RATINGS (Design-Maximum Values)**

RMS Heater-Tap Voltage, when panel lamp falls .....	14	volts
Plate Voltage .....	150	volts
Grid-No.2 (Screen-Grid) Voltage .....	130	volts
Plate Dissipation .....	5.5	watts
Grid-No.2 Input .....	2	watts

**CHARACTERISTICS**

Plate Supply Voltage .....	110	volts
Grid-No.2 Voltage .....	115	volts
Peak AF Grid-No.1 (Control-Grid) Voltage .....	2	volts
Cathode-Bias Resistor .....	62	ohms
Zero-Signal Plate Current .....	42	mA
Maximum-Signal Plate Current .....	42	mA
Zero-Signal Grid-No.2 Current .....	11.5	mA
Maximum-Signal Grid-No.2 Current .....	14.5	mA
Plate Resistance (Approx.) .....	11000	ohms
Transconductance .....	14600	μmhos
Load Resistance .....	3000	ohms
Total Harmonic Distortion (Approx.) .....	7	per cent
Maximum-Signal Power Output .....	1.4	watts



**POWER PENTODE**

**50HK6**

Miniature type used in audio-frequency power-output stage of radio receivers. Outlines section, 5D; requires miniature 7-contact socket. The heater is provided with a tap for operation of a panel lamp. Heater: volts (ac/dc), 50; amperes, 0.15; tap volts (without panel lamp), 7; maximum heater-cathode volts, ±200 peak, 100 average.

**Class A<sub>1</sub> Amplifier**

**MAXIMUM RATINGS (Design-Maximum Values)**

Plate Voltage .....	150	volts
Grid-No.2 (Screen-Grid) Voltage .....	130	volts
Plate Dissipation .....	5.5	watts
Grid-No.2 Input .....	1.1	watts
RMS Heater-Tap Voltage When Panel Lamp Falls .....	14	volts

**TYPICAL OPERATION AND CHARACTERISTICS**

Plate Voltage .....	110	volts
Grid-No.2 Voltage .....	110	volts
Grid-No.1 (Control-Grid) Voltage .....	-7.5	volts
Peak AF Grid-No.1 Voltage .....	7.5	volts
Zero-Signal Plate Current .....	49	mA
Maximum-Signal Plate Current .....	50	mA



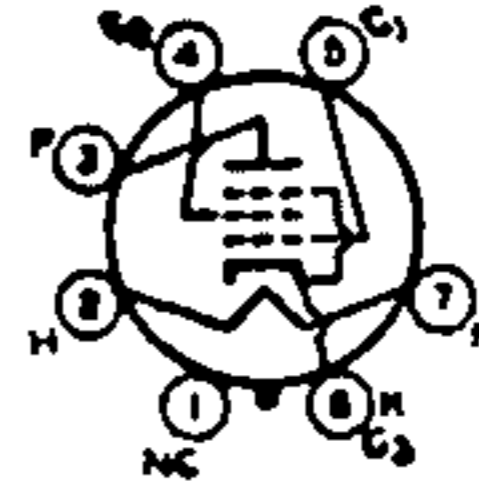
Zero-Signal Grid-No.2 Current .....	4	mA
Maximum-Signal Grid-No.2 Current .....	8.5	mA
Plate Resistance (Approx.) .....	10000	ohms
Transconductance .....	7600	$\mu$ mbos
Load Resistance .....	2500	ohms
Total Harmonic Distortion (Approx.) .....	8	per cent
Maximum-Signal Power Output .....	1.9	watts
<b>MAXIMUM CIRCUIT VALUES</b>		
Grid-No.1-Circuit Resistance:		
For fixed-bias operation .....	0.1	megohms
For cathode-bias operation .....	0.5	megohms

## 50L6GT

25L6GT

### BEAM POWER TUBE

Glass octal type used in output stage of ac/dc radio receivers. Outlines section, 13D; requires octal socket. This type may be supplied with pin No.1 omitted. Refer to miniature type 50C5 for installation and application information. Type 25L6GT is identical with type 50L6GT except for heater ratings.



TAC

	<b>25L6GT</b>	<b>50L6GT</b>	
Heater Voltage (ac/dc) .....	25	50	volts
Heater Current .....	0.3	0.15	ampere
Peak Heater-Cathode Voltage .....	$\pm 90$ max	$\pm 90$ max	volts
Direct Interelectrode Capacitances (Approx.):			
Grid No.1 to Plate .....		0.6	pF
Grid No.1 to Cathode, Heater, Grid No.2, and Grid No.3 .....		15	pF
Plate to Cathode, Heater, Grid No.2, and Grid No.3 .....		9.5	pF

### Class A<sub>1</sub> Amplifier

<b>MAXIMUM RATINGS (Design-Center Values)</b>			
Plate Voltage .....		200	volts
Grid-No.2 (Screen-Grid) Voltage .....		125	volts
Plate Dissipation .....		10	watts
Grid-No.2 Input .....		1.25	watts
<b>TYPICAL OPERATION</b>			
	<b>Fixed Bias</b>	<b>Cathode Bias</b>	
Plate Supply Voltage .....	110	200	volts
Grid-No.2 Supply Voltage .....	110	125	volts
Grid-No.1 (Control-Grid) Voltage .....	-7.5	—	volts
Peak AF Grid-No.1 Voltage .....	7.5	8.0	volts
Cathode-Bias Resistor .....	—	180	ohms
Zero-Signal Plate Current .....	49	46	mA
Maximum-Signal Plate Current .....	60	47	mA
Zero-Signal Grid-No.2 Current .....	4	2.2	mA
Maximum-Signal Grid-No.2 Current .....	10	8.5	mA
Plate Resistance (Approx.) .....	18000	26000	ohms
Transconductance .....	8000	8000	$\mu$ mbos
Load Resistance .....	2000	4900	ohms
Total Harmonic Distortion .....	10	10	per cent
Maximum-Signal Power Output .....	2.1	8.8	watts

**50X6**

Refer to chart at end of section.

**50Y6GT**

Refer to chart at end of section.

**50Y7GT**

Refer to chart at end of section.

**50Z7G**

Refer to chart at end of section.

**53**

Refer to chart at end of section.

**60FX5**

Refer to type 12FX5.

**70L7GT**

Refer to chart at end of section.

**75**

Refer to chart at end of section.

**78**

Refer to chart at end of section.

**80**

Refer to chart at end of section.

**84/6Z4**

Refer to chart at end of section.

Refer to chart at end of section.

117L7GT/M7G1

Refer to chart at end of section.

117N7GT

Refer to chart at end of section.

117P7GT

Refer to chart at end of section.

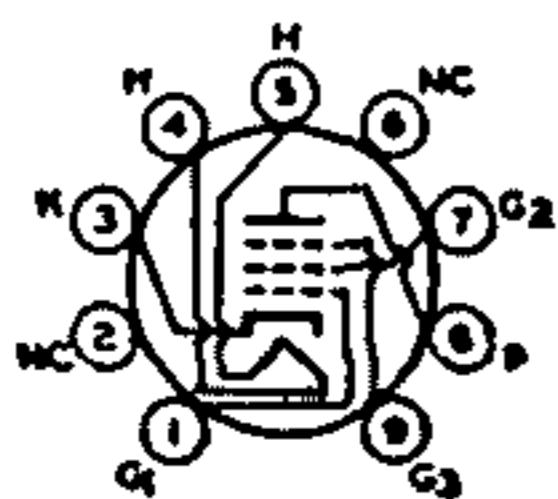
117Z3

Refer to chart at end of section.

117Z4GT

Refer to chart at end of section.

117Z6GT



9AD

SHARP-CUTOFF PENTODE

5879

Miniature type used as audio amplifier in the input stages of medium-gain public-address systems, home sound recorders, and audio systems. Outlines section, 6B; requires miniature 9-contact socket. For operation as resistance-coupled amplifier, refer to Resistance-Coupled Amplifier section.

Heater Voltage (ac/dc)	6.3	volts
Heater Current	0.15	ampere
Peak Heater-Cathode Voltage	±100 max	volts
Direct Interelectrode Capacitances:		
Pentode Connection:		
Grid No.1 to Plate	0.11 max	pF
Grid No.1 to Cathode, Heater, Grid No.2, and Grid No.3	2.7	pF
Plate to Cathode, Heater, Grid No.2, and Grid No.3	2.4	pF
Triode Connection*:		
Grid No.1 to Plate	1.4	pF
Grid No.1 to Cathode and Heater	1.4	pF
Plate to Cathode and Heater	0.85	pF

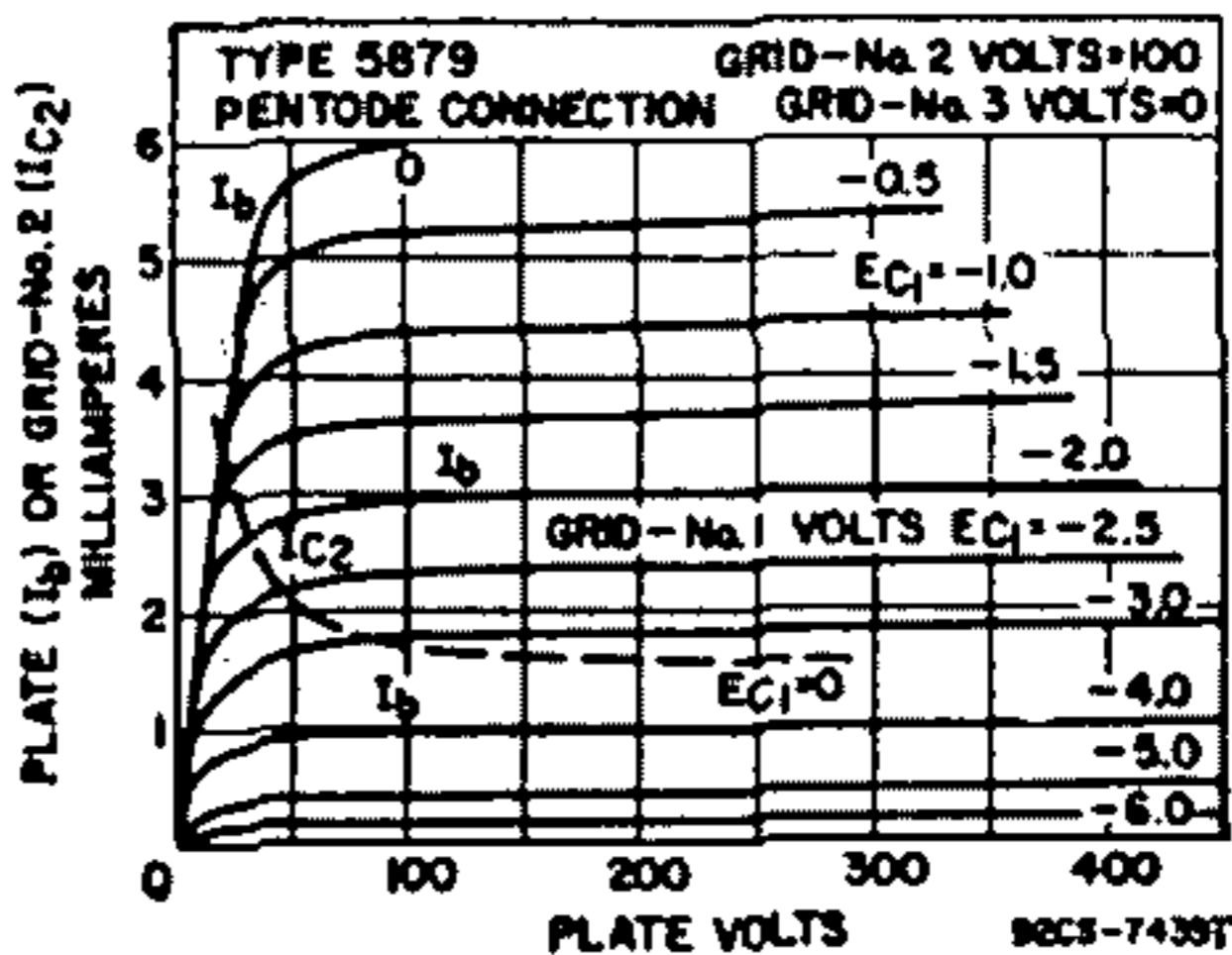
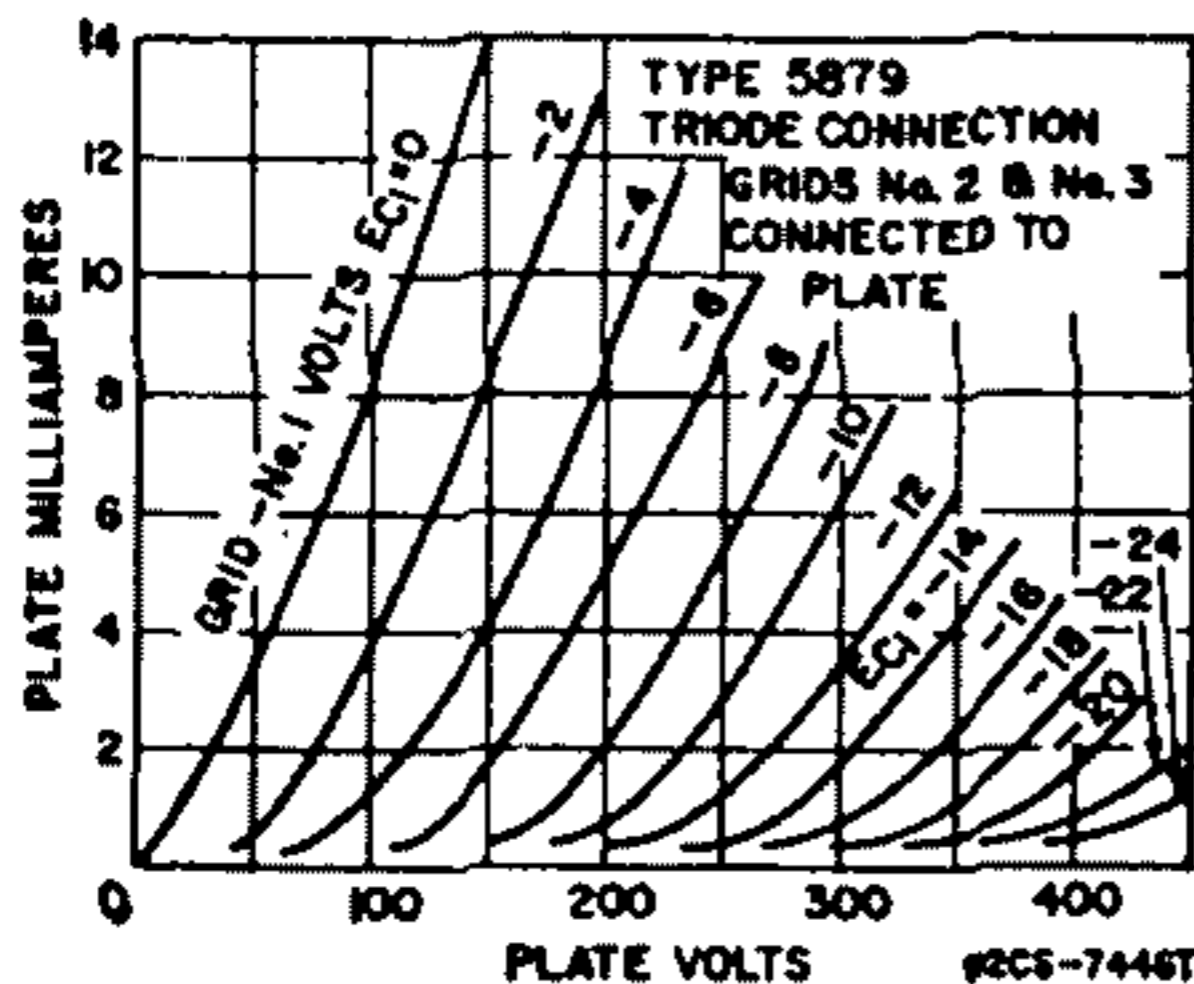
\* Grid No.2 and grid No.3 connected to plate.

Class A<sub>1</sub> Amplifier

MAXIMUM RATINGS (Design-Maximum Values)

Plate Voltage	275	volts
Grid-No.2 (Screen-Grid) Voltage	— See curve page 96	
Grid-No.2 Supply Voltage	330	volts
Grid-No.1 (Control-Grid) Voltage:		
Negative-bias value	-55	volts
Positive-bias value	0	volts
Plate Dissipation	1.7	watts
Grid-No.2 Input:		
For grid-No.2 voltages up to 165 volts	— 0.25	watt
For grid-No.2 voltages between 165	— See curve page 96	

	Triode Connection*	Pentode Connection	
Plate Voltage	275	330	volts
Grid-No.2 (Screen-Grid) Voltage	— See curve page 96		
Grid-No.2 Supply Voltage	—	330	volts
Grid-No.1 (Control-Grid) Voltage:			
Negative-bias value	-55	-55	volts
Positive-bias value	0	0	volts
Plate Dissipation	1.7	1.25	watts
Grid-No.2 Input:			
For grid-No.2 voltages up to 165 volts	—	0.25	watt
For grid-No.2 voltages between 165	— See curve page 96		



**CHARACTERISTICS**

Plate Voltage	100	250	250	volts
Grid No. 3	—	—	Connected to cathode at socket	
Grid-No.2 Voltage	—	—	100	volts
Grid-No.1 Voltage	-8	-8	-8	volts
Amplification Factor	21	21	—	
Plate Resistance (Approx.)	0.017	0.0137	2	megohms
Transconductance	1240	1530	1000	μmhos
Plate Current	2.2	5.5	1.8	mA
Grid-No.2 Current	—	—	0.4	mA
Grid-No.1 Voltage (Approx.) for plate current of 10 μA	—	—	-8	volts

**MAXIMUM CIRCUIT VALUE**

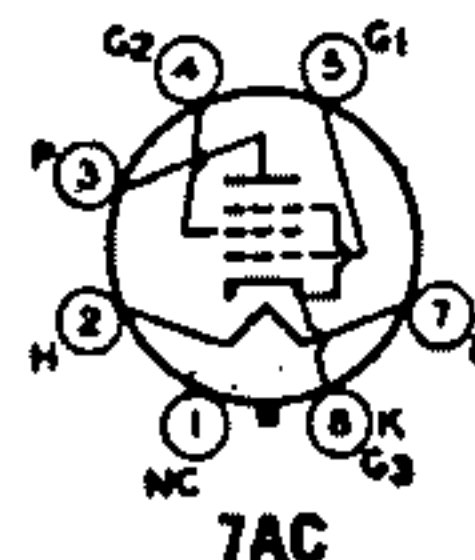
Grid-No.1-Circuit Resistance	2.2	megohms
------------------------------	-----	---------

\* Grid No.2 and grid No.3 connected to plate.

**5881**

**BEAM POWER TUBE**

Glass octal type used in the output stages of radio receivers and high-fidelity audio amplifiers. Outlines section, 29M; requires octal socket. For typical operation as push-pull class A<sub>1</sub>, class AB<sub>1</sub> (within maximum ratings), and class AB<sub>2</sub> amplifier; and for curves of average plate characteristics, refer to type 6L6GC. Heater: volts (ac/dc), 6.3; amperes, 0.9; maximum heater-cathode volts, ±200 peak.



**Class A<sub>1</sub> Amplifier**

**MAXIMUM RATINGS (Design-Center Values)**

	Triode Connection*	Pentode Connection	
Plate Voltage	400	400	volts
Grid-No.2 (Screen-Grid) Voltage	—	400	volts
Plate Dissipation	26	23	watts
Grid-No.2 Input	—	3	watts

**TYPICAL OPERATION AND CHARACTERISTICS**

	250	300	250	350	
Plate Voltage	—	—	250	350	volts
Grid-No.2 Voltage	—	—	250	250	volts
Grid-No.1 (Control-Grid) Voltage	-18	-20	-14	-18	volts
Peak AF Grid-No.1 Voltage	18	20	14	18	volts
Zero-Signal Plate Current	52	78	75	53	mA
Maximum-Signal Plate Current	58	85	80	65	mA
Zero-Signal Grid-No.2 Current	—	—	4.3	2.5	mA
Maximum-Signal Grid-No.2 Current	—	—	7.6	8.5	mA
Amplification Factor	8	—	—	—	
Plate Resistance (Approx.)	—	—	30000	48000	ohms
Transconductance	5250	—	6100	5200	μmhos
Load Resistance	4000	4000	2500	4200	ohms
Total Harmonic Distortion	6	5.5	10	13	per cent
Maximum-Signal Power Output	1.4	1.8	6.7	11.3	watts

**MAXIMUM CIRCUIT VALUES**

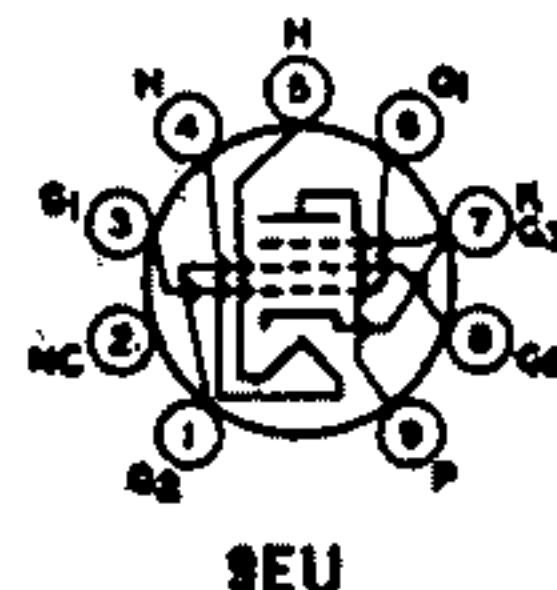
Grid-No.1-Circuit Resistance:		
For fixed-bias operation	0.1	megohms
For cathode-bias operation	0.5	megohms

\* Grid No.2 connected to plate.

**6973**

**BEAM POWER TUBE**

Miniature type used as power amplifier in compact high-fidelity audio equipment. Outlines section, 6G; requires miniature 9-contact socket.



Heater Voltage (ac/dc)	6.3	volts
Heater Current	0.45	ampere
Heater-Cathode Voltage:		
Peak value	±200 max	volts
Average value	100 max	volts



Direct Interelectrode Capacitances:

Grid-No.1 to Plate .....	0.4 max	pF
Grid No.1 to Cathode, Heater, Grid No.2, and Grid No.3 .....	9	pF
Plate to Cathode, Heater, Grid No.2, and Grid No.3 .....	6	pF

**Class A<sub>1</sub> Amplifier**

**CHARACTERISTICS**

Plate Voltage .....	250	volts
Grid-No.2 (Screen-Grid) Voltage .....	250	volts
Grid-No.1 (Control-Grid) Voltage .....	-15	volts
Plate Resistance (Approx.) .....	73000	ohms
Transconductance .....	4800	$\mu$ mbos
Plate Current .....	46	mA
Grid-No.2 Current .....	3.5	mA
Grid-No.1 Voltage (Approx.) for plate current of 100 $\mu$ A .....	-40	volts

**Push-Pull Class AB<sub>1</sub> Amplifier**

**MAXIMUM RATINGS (Design-Maximum Values)**

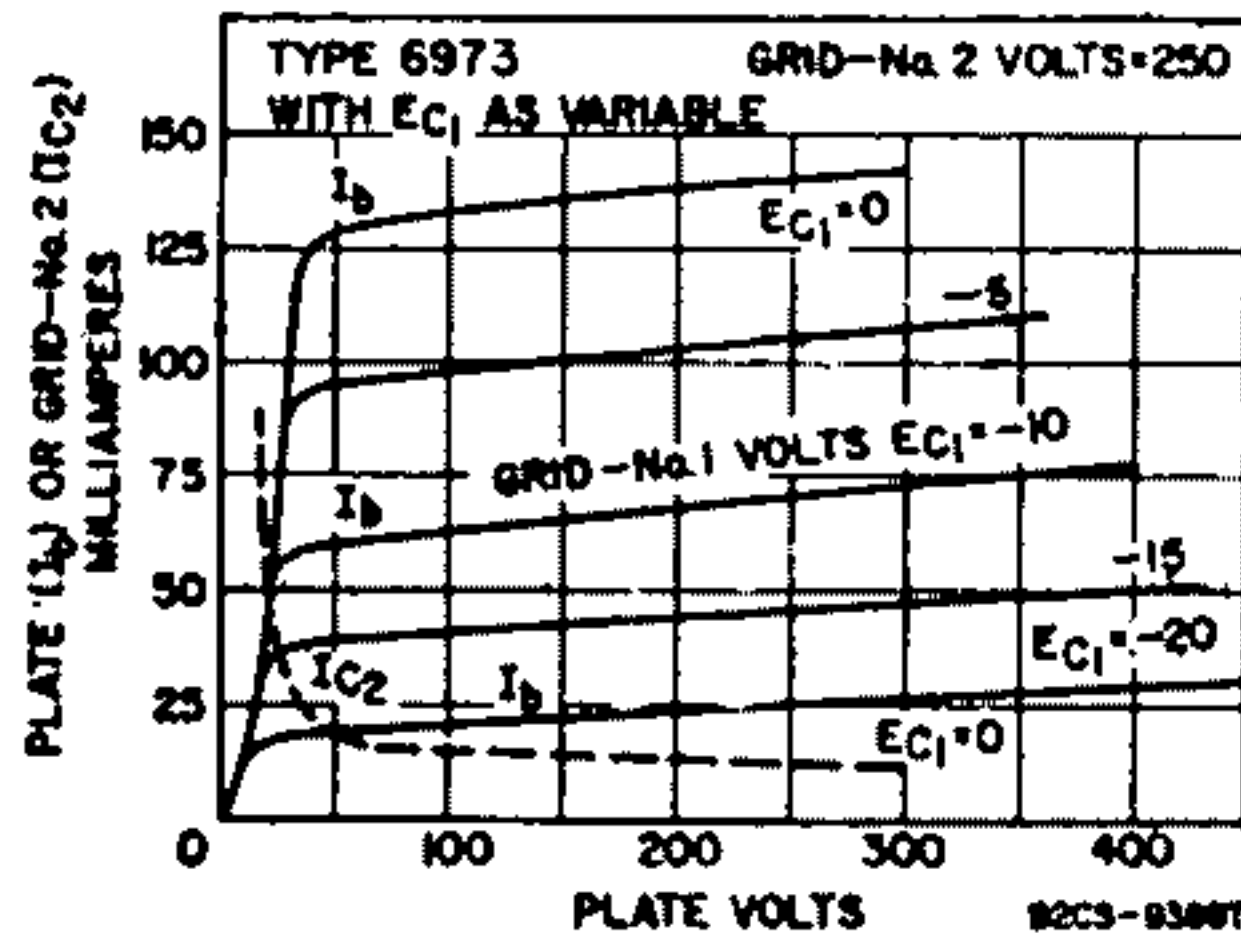
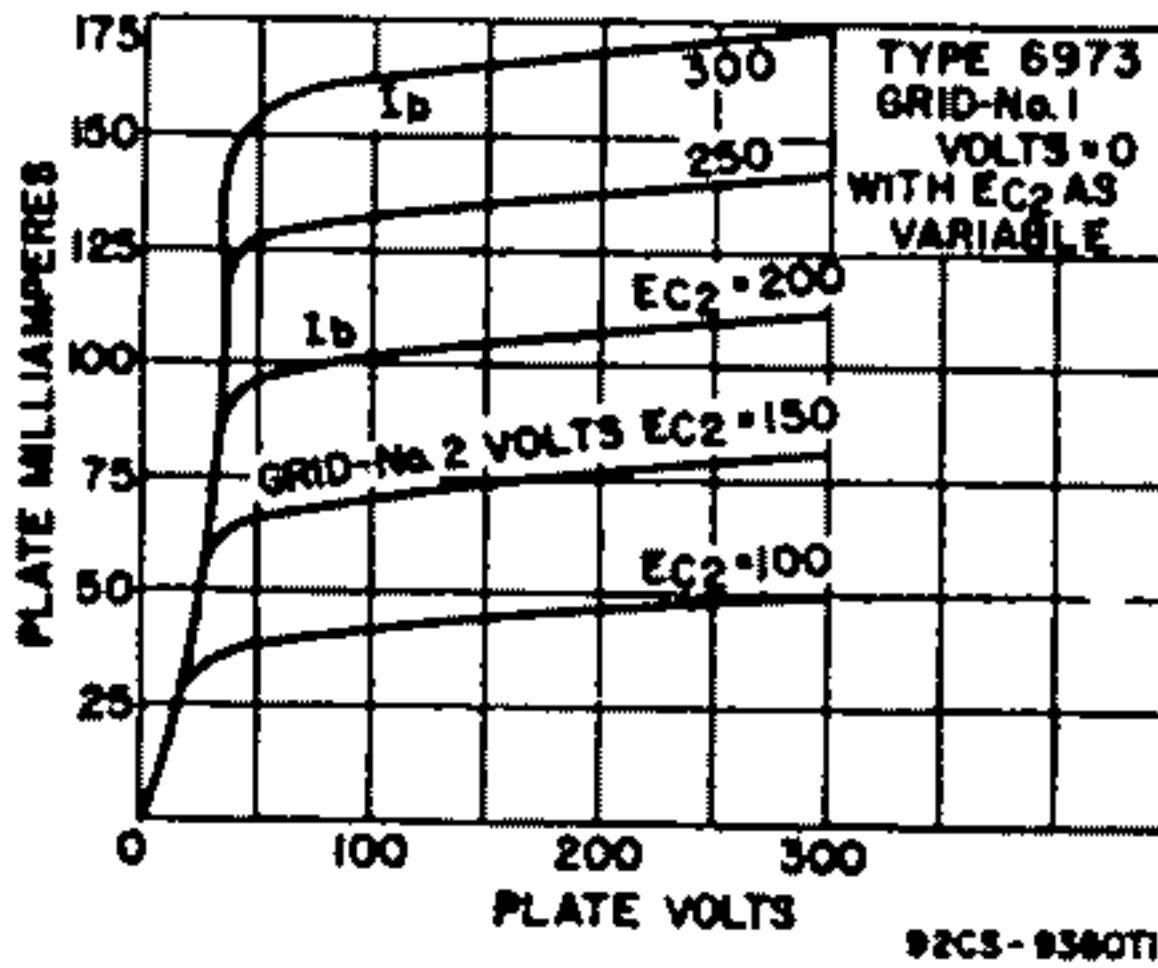
Plate Voltage .....	440	volts
Grid-No.2 Voltage .....	330	volts
Plate Dissipation .....	12	watts
Grid-No.2 Input .....	2	watts
Bulb Temperature (At hottest point) .....	250	$^{\circ}$ C

**TYPICAL OPERATION (Values are for two tubes)**

	Fixed Bias			Cathode Bias		
Plate Supply Voltage .....	250	350	400	300	310	volts
Grid-No.2 Supply Voltage .....	250	280	290	300	310	volts
Grid-No.1 Voltage .....	-15	-22	-25	—	—	volts
Cathode-Bias Resistor .....	—	—	—	230	270	ohms
Peak AF Grid-No.1-to-Grid-No.1 Voltage .....	30	44	50	48	55	volts
Zero-Signal Plate Current .....	92	58	50	80	77	mA
Maximum-Signal Plate Current .....	105	108	107	98	92	mA
Zero-Signal Grid-No.2 Current .....	7	3.5	2.5	6	5	mA
Maximum-Signal Grid-No.2 Current ..	16	14	13.7	14	14	mA
Effective Load Resistance (Plate-to-plate) .....	8000	7500	8000	5500	6000	ohms
Total Harmonic Distortion .....	2	1.5	2	2	4	per cent
Maximum-Signal Power Output .....	12.5	20	24	15	17	watts

**MAXIMUM CIRCUIT VALUES**

Grid-No.1-Circuit Resistance:		
For fixed-bias operation .....	0.5	megohm
For cathode-bias operation .....	1	megohm



**Push-Pull Class AB<sub>1</sub> Amplifier**

Grid No.2 of Each Tube Connected to Tap on Plate Winding of Output Transformer

**MAXIMUM RATINGS (Design-Maximum Values)**

Plate and Grid-No.2 Supply Voltage .....	410	volts
Plate Dissipation .....	12	watts
Grid-No.2 Input .....	1.75	watts
Bulb Temperature (At hottest point) .....	250	$^{\circ}$ C

**TYPICAL OPERATION (Values are for two tubes)**

	Fixed Bias	Cathode Bias	
Plate Supply Voltage .....	375	370	volts
Grid-No.2 Supply Voltage .....	—	—	volts
Grid-No.1 Voltage .....	-32.5	—	volts

Cathode-Bias Resistor .....	—	355	ohms
Peak AF Grid-No.1-to-Grid-No.1 Voltage .....	67	82	volts
Zero-Signal Cathode Current .....	62	74	mA
Maximum-Signal Cathode Current .....	95	84	mA
Effective Load Resistance (Plate-to-plate) .....	12500	13000	ohms
Total Harmonic Distortion .....	1.5	1.2	per cent
Maximum-Signal Power Output .....	18.5	15	watts

**MAXIMUM CIRCUIT VALUES**

Grid-No.1-Circuit Resistance:			
For fixed-bias operation .....		0.1	megohm
For cathode-bias operation .....		1	megohm

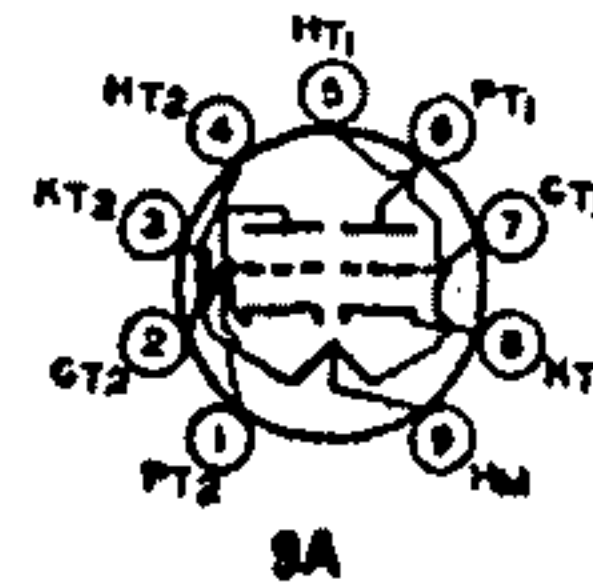
\* Obtained from taps on the primary winding of the output transformer. The taps are located on each side of the center tap (B+) so as to apply 50 per cent of the plate signal voltage to grid No.2 of each output tube.

# Obtained from taps on the primary winding of the output transformer. The taps are located on each side of the center tap (B+) so as to supply 43 per cent of the plate signal voltage to grid No.2 of each output tube.

\* The type of input-coupling network used should not introduce too much resistance in the grid-No.1 circuit. Transformer- or impedance-coupling devices are recommended.

**7025 HIGH-MU TWIN TRIODE**

Miniature type used as phase inverter or resistance-coupled amplifier in high-quality, high-fidelity audio amplifiers. Outlines section, 6B; requires miniature 7-contact socket. This type is identical with miniature type 12AX7A except that it has a controlled equivalent noise and hum characteristic. For operation as resistance-coupled amplifier, refer to Resistance-Coupled Amplifier section.



**EQUIVALENT-NOISE AND HUM VOLTAGE REFERENCED TO GRID (Each Unit)**

Average Value (rms)† .....	1.8	μV
Maximum Value (rms)* .....	7	μV

† Measured in "true rms" units under following conditions: heater volts (ac), 6.3 (parallel connection); center tap of heater transformer connected to ground; plate supply volts, 250; plate load resistor, 2700 ohms; cathode-bypass capacitor, 100 μF; grid resistor, 0 ohms; and amplifier covering frequency range between 25 to 10000 cycles per second.

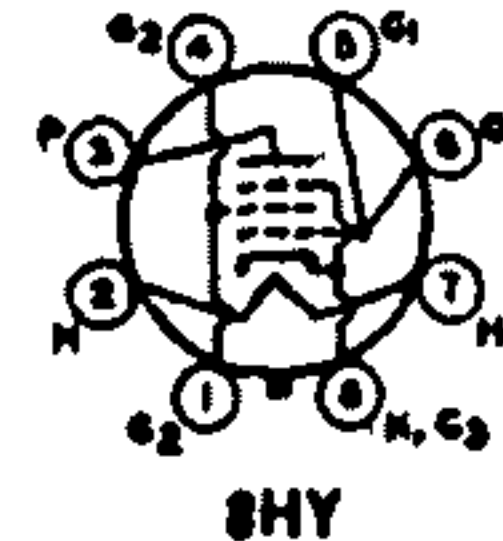
\* Same conditions as for "Average Value" except cathode resistor is unbypassed and grid resistor is 0.05 megohm.

**7027**

Refer to chart at end of section.

**7027A BEAM POWER TUBE**

Glass octal type used in push-pull power amplifier circuits of high-fidelity audio equipment. Outlines section, 9F; requires octal socket. This tube, like other power-handling tubes, should be adequately ventilated.



Heater Voltage (ac/dc) .....	6.3	volts
Heater Current .....	0.9	ampere
Heater-Cathode Voltage:		
Peak value .....	±240 max	volts
Average value .....	100 max	volts
Direct Interelectrode Capacitances (Approx.):		
Grid No.1 to Plate .....	1.5	pF
Grid No.1 to Cathode, Heater, Grid No.2, and Grid No.3 .....	10	pF
Plate to Cathode, Heater, Grid No.2, and Grid No.3 .....	7.5	pF

**Class A<sub>1</sub> Amplifier**

<b>CHARACTERISTICS</b>		
Plate Voltage .....	250	volts
Grid-No.2 (Screen-Grid) Voltage .....	250	volts
Grid-No.1 (Control-Grid) Voltage .....	-14	volts
Plate Resistance (Approx.) .....	22500	ohms
Transconductance .....	6000	μmhos
Plate Current .....	72	mA
Grid-No.2 Current .....	5	mA

**Push-Pull Class AB<sub>1</sub> Amplifier**

**MAXIMUM RATINGS (Design-Maximum Values)**

Plate Voltage	600	volts
Grid-No.2 Voltage	500	volts
Plate Dissipation	35	watts
Grid-No.2 Input	6	watts

**TYPICAL OPERATION (Values are for two tubes)**

	Fixed Bias			Cathode Bias			
	400	450	540	400	380	425	
Plate Supply Voltage	400	450	540	400	380	425	volts
Grid-No.2 Supply Voltage	300	350	400	300	380	415	volts
Grid-No.1 Voltage	-25*	-30*	-38*	—	—	—	volts
Cathode-Bias Resistor	—	—	—	200	180	200	ohms
Peak AF Grid-No.1-to-Grid-No.1 Voltage	50	60	76	57	68.5	86	volts
Zero-Signal Plate Current	102	95	100	112	138	150	mA
Maximum-Signal Plate Current	152	194	220	128	170	196	mA
Zero-Signal Grid-No.2 Current	6	3.4	5	7	5.6	8	mA
Maximum-Signal Grid-No.2 Current	17	19.2	21.4	16	20	20	mA
Effective Load Resistance (Plate-to-plate)	6600	6000	6500	6600	4500	3800	ohms
Total Harmonic Distortion	2	1.6	2	2	3.5	4	per cent
Maximum-Signal Power Output	34	50	76	32	36	44	watts

**MAXIMUM CIRCUIT VALUES**

Grid-No.1-Circuit Resistance:		
For fixed-bias operation*	0.1	megohm
For cathode-bias operation	0.5	megohm

\* The type of input coupling network used should not introduce too much resistance in the grid-No.1 circuit. Transformer- or impedance-coupling devices are recommended.

**Push-Pull Class AB<sub>1</sub> Amplifier**

Grid No.2 of Each Tube Connected to Tap on Plate Winding of Output Transformer

**MAXIMUM RATINGS (Design-Maximum Values)**

Plate and Grid-No.2 Supply Voltage	600	volts
Plate Dissipation	35	watts
Grid-No.2 Input	4.5	watts

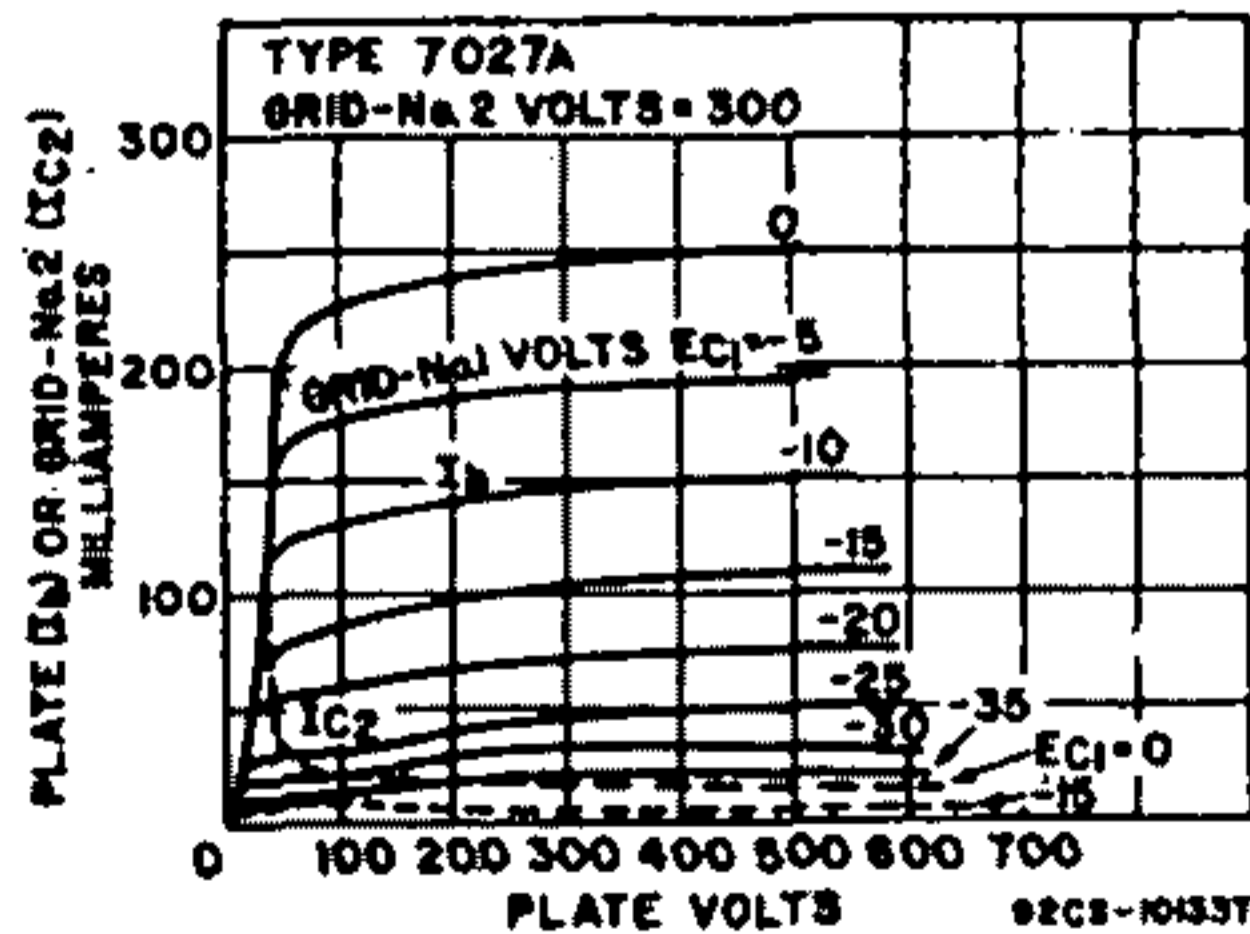
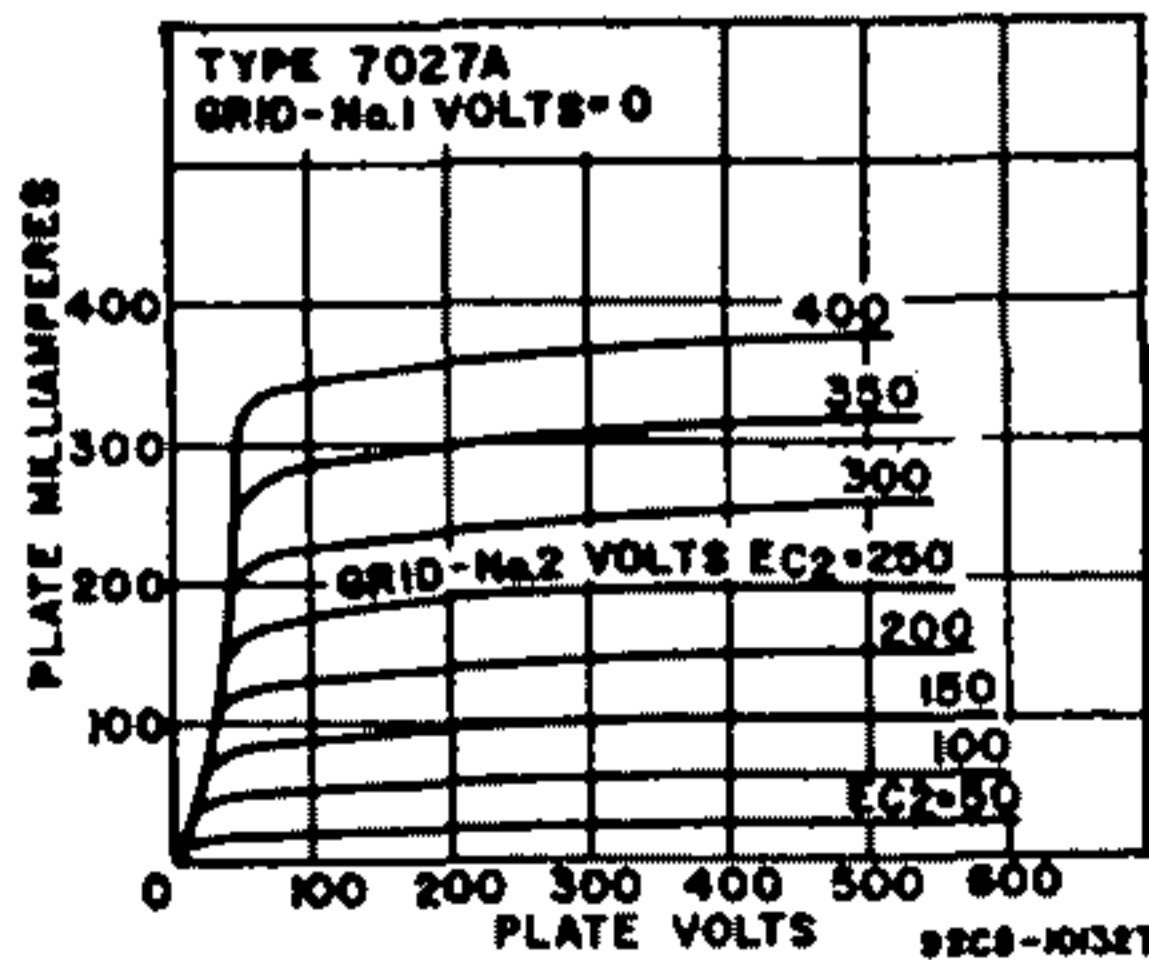
**TYPICAL OPERATION (Values are for two tubes)**

Plate Supply Voltage	410	volts
Grid-No.2 Supply Voltage	*	volts
Cathode-Bias Resistor	220	ohms
Peak AF Grid-No.1-to-Grid-No.1 Voltage	68	volts
Zero-Signal Cathode Current	134	mA
Maximum-Signal Cathode Current	155	mA
Effective Load Resistance (Plate to plate)	8000	ohms
Total Harmonic Distortion	1.6	per cent
Maximum-Signal Power Output	24	watts

**MAXIMUM CIRCUIT VALUE**

Grid-No.1-Circuit Resistance, for cathode-bias operation	0.5	megohm
--	-----	--------

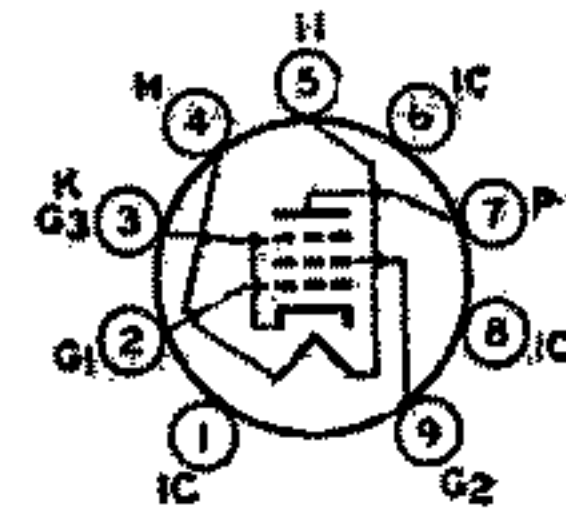
\* Obtained from taps on the primary winding of the output transformer. The taps are located on each side of the center tap (B+) so as to apply 48 per cent of the plate signal voltage to grid No.2 of each output tube.





# 7189

## POWER PENTODE



B10

Miniature type used as power amplifier tube in high-fidelity audio equipment. Outlines section, 6G; requires miniature 9-contact socket.

Heater Voltage .....	6.3	volts
Heater Current .....	0.76	ampere
Peak Heater-Cathode Voltage .....	±100 max	volts
Direct Interelectrode Capacitances (Approx.):		
Grid No.1 to Plate .....	0.5	pF
Grid No.1 to Cathode, Heater, Grid No.2, and Grid No.3 .....	10.8	pF
Plate to Cathode, Heater, Grid-No.2, and Grid No.3 .....	6.5	pF
Grid No.1 to Heater .....	0.25	pF

### Class A<sub>1</sub> Amplifier

#### CHARACTERISTICS

Plate Voltage .....	250	volts
Grid-No.2 (Screen-Grid) Voltage .....	250	volts
Grid-No.1 (Control-Grid) Voltage .....	-7.3	volts
Mu-Factor, Grid No.2 to Grid No.1 .....	19.5	
Plate Resistance (Approx.) .....	40000	ohms
Transconductance .....	11300	μmhos
Plate Current .....	48	mA
Grid-No.2 Current .....	5.5	mA

### Push-Pull Class AB<sub>1</sub> Amplifier

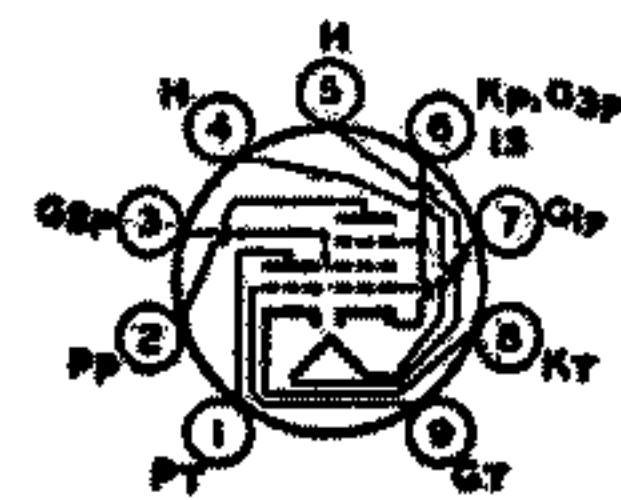
		Grid-No.2 Special Connection*	
<b>MAXIMUM RATINGS (Design-Center Values)</b>			
Plate Voltage .....	400	375	volts
Grid-No.2 Voltage .....	300	*	volts
Cathode Current .....	65	65	mA
Plate Dissipation .....	12	12	watts
Zero-Signal Grid-No.2 Input .....	2	2	watts
Maximum-Signal Grid-No.2 Input .....	4	4	watts
<b>TYPICAL OPERATION (Values are for two tubes)</b>			
Plate Supply Voltage .....	—	375	volts
Plate Voltage .....	400	—	volts
Grid-No.2 Supply Voltage .....	—	*	
Grid-No.2 Voltage .....	300	*	volts
Grid-No.1 Voltage .....	-15	—	volts
Cathode-Bias Resistor .....	—	220	ohms
Peak AF Grid-No.1 Voltage .....	14.8	17.7	volts
Zero-Signal Plate Current .....	15	70	mA
Maximum-Signal Plate Current .....	105	81	mA
Zero-Signal Grid-No.2 Current .....	1.6	*	mA
Maximum-Signal Grid-No.2 Current .....	25	*	mA
Effective Load Resistance (Plate-to-plate) .....	8000	11000	ohms
Total Harmonic Distortion .....	4	3	per cent
Maximum-Signal Power Output .....	24	16.5	watts
<b>MAXIMUM CIRCUIT VALUES</b>			
Grid-No.1-Circuit Resistance .....	0.3	1	megohm

\* Grid No.2 of each tube connected to tap on plate winding of output transformer.  
 \* Obtained from taps on primary winding of the output transformer. The taps are located on each side of the center tap (B+) so as to supply 43 per cent of the plate signal voltage to grid No.2 of each output tube.

# 7199

## MEDIUM-MU TRIODE— SHARP-CUTOFF PENTODE

Miniature type used in high-quality, high-fidelity audio equipment, particularly in phase splitters, tone-control amplifiers, and high-gain voltage amplifiers. Outlines section, 6B; requires miniature 9-contact socket. For operation as resistance-coupled amplifier, refer to Resistance-Coupled Amplifier section. In direct-coupled voltage-amplifier phase-splitter circuits, the pentode unit should drive the triode unit.



9JT

Heater Voltage (ac/dc)	6.3	volts
Heater Current	0.45	ampere
Heater-Cathode Voltage:		
Peak value	±200 max	volts
Average value	100 max	volts
Direct Interelectrode Capacitances:		
Triode Unit:		
Grid to Plate	2	pF
Grid to Cathode and Heater	2.3	pF
Plate to Cathode and Heater	0.8	pF
Pentode Unit:		
Grid No.1 to Plate	0.06 max	pF
Grid No.1 to Cathode, Heater, Grid No.2, Grid No.3, and Internal Shield	5	pF
Plate to Cathode, Heater, Grid No.2, Grid No.3, and Internal Shield	2	pF

**EQUIVALENT-NOISE AND HUM VOLTAGE REFERENCED TO GRID**

	Triode Unit Pentode Unit		
Median Value (rms)	10†	85*	μV
Maximum Value (rms)	150†	100*	μV

† Measured in "true rms" units under the following conditions: heater volts (ac), 6.3; center tap of heater transformer connected to ground; plate-supply volts, 250; plate load resistor, 0.1 megohm; cathode resistor, 1500 ohms; grid resistor, 0.05 megohm; and amplifier covering frequency range between 25 and 10000 cycles per second.

\* Same conditions as for triode unit except: grid-No.2 supply volts, 250; grid-No.2 resistor, 0.33 megohm; grid-No.2-bypass capacitor, 0.22 μF; cathode resistor, 1200 ohms; and grid-No.1 resistor, 0.05 megohm.

**Class A<sub>1</sub> Amplifier**

**MAXIMUM RATINGS (Design-Maximum Values)**

	Triode Unit Pentode Unit		
Plate Voltage	330	330	volts
Grid-No.2 (Screen-Grid) Voltage	—	See curve page 96	
Grid-No.2 Supply Voltage	—	350	volts
Grid-No.1 (Control-Grid) Voltage, Positive-bias value	0	0	volts
Plate Dissipation	2.4	3	watts
Grid-No.2 Input:			
For grid-No.2 voltages up to 165 volts	—	0.6	watt
For grid-No.2 voltages between 165 and 330 volts	—	See curve page 96	

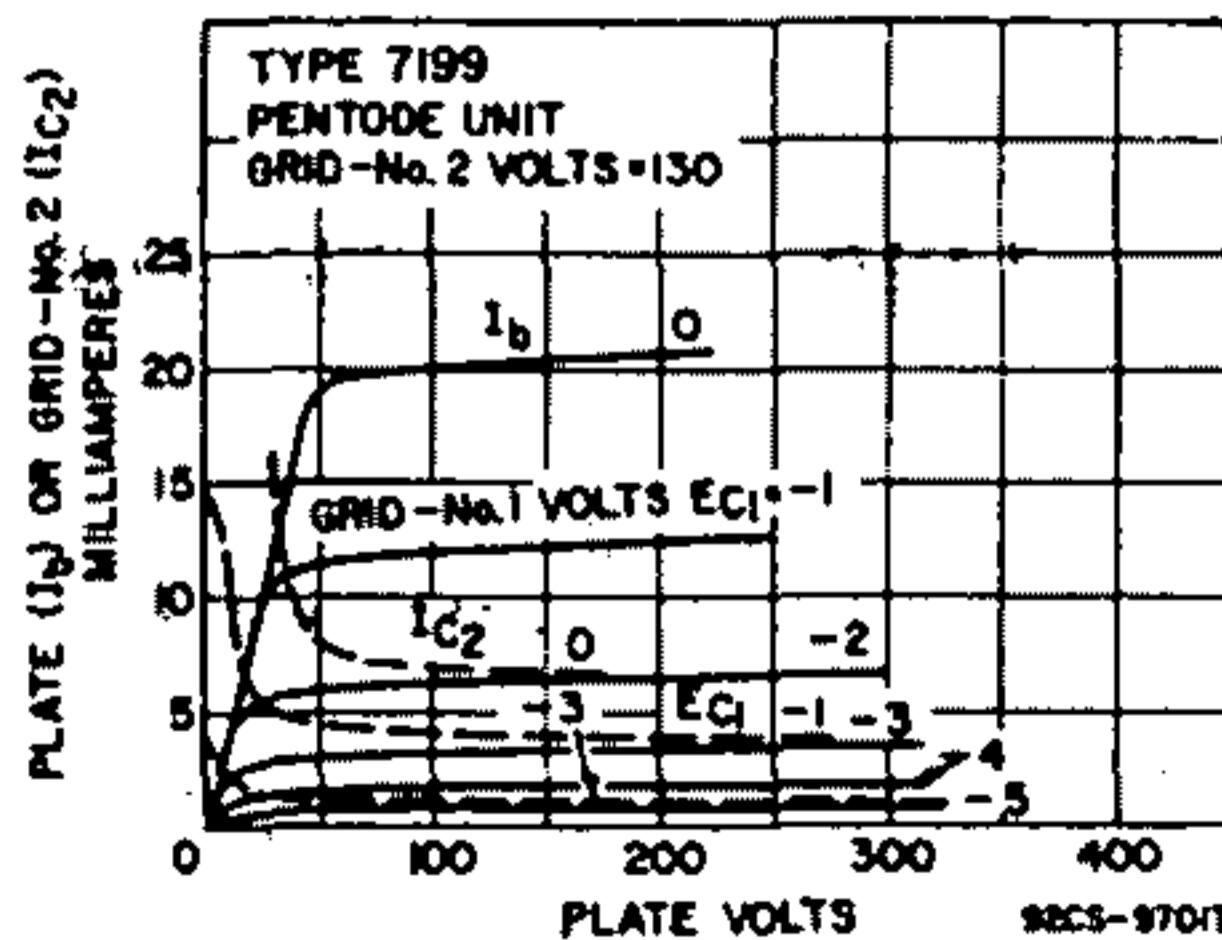
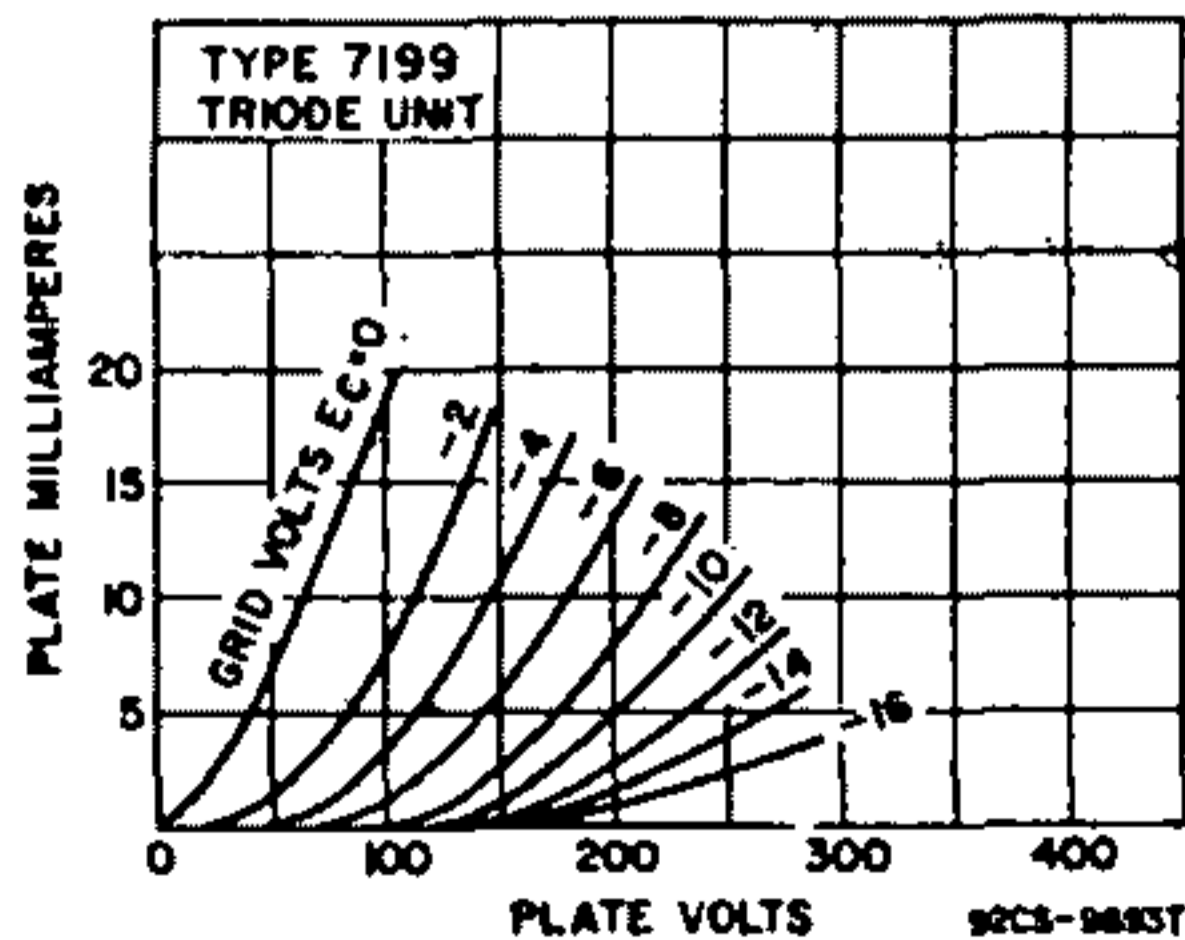
**CHARACTERISTICS**

	Triode Unit Pentode Unit		
Plate Supply Voltage	215	100 220	volts
Grid-No.2 Supply Voltage	—	50 130	volts
Grid-No.1 Voltage	-8.5	—	volts
Cathode-Bias Resistor	—	1000 62	ohms
Amplification Factor	17	—	
Plate Resistance (Approx.)	0.0081	1 0.4	megohm
Transconductance	2100	1500 1000	μmhos
Plate Current	9	1.1 12.5	mA
Grid-No.2 Current	—	0.85 3.5	mA
Grid-No.1 Voltage (Approx.) for plate current of 10 μA	-40	-4 —	volts

**MAXIMUM CIRCUIT VALUES**

	Triode Unit Pentode Unit		
Grid-No.1-Circuit Resistance:*			
For fixed-bias operation	0.5	0.25	megohm
For cathode-bias operation	1.0	1.0	megohm

\* If either unit is operated at maximum rated conditions, grid-No.1-circuit resistance for both units should not exceed the stated value.

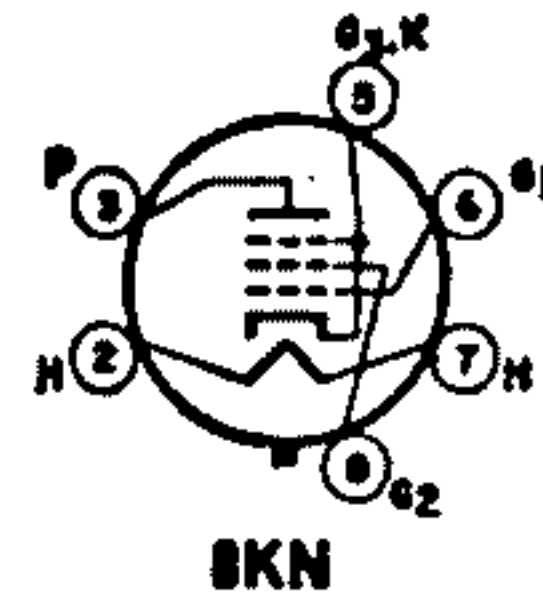


7247

Refer to chart at end of section.

## 7355 POWER PENTODE

Glass octal type used in the power-output stage of high-fidelity audio-frequency amplifier systems. Outlines section, 13F; requires octal socket. Heater: volts (ac/dc), 6.3; amperes, 0.8; maximum heater-cathode volts,  $\pm 200$  peak, 100 average.



### Class A<sub>1</sub> Amplifier

#### MAXIMUM RATINGS (Design-Maximum Values)

Plate Voltage	500	volts
Grid-No.2 (Screen-Grid) Voltage	400	volts
Grid-No.1 (Control-Grid) Voltage, Positive-bias value	0	volts
Average Cathode Current	100	mA
Plate Dissipation	18	watts
DC Grid-No.2 Input	8.5*	volts

#### TYPICAL OPERATION AND CHARACTERISTICS

Plate Voltage	250	volts
Grid-No.2 Voltage	225	volts
Grid-No.1 Voltage	-15	volts
Peak AF Grid-No.1 Voltage	15	volts
Plate Resistance (Approx.)	42000	ohms
Transconductance	7600	$\mu$ mhos
Zero-Signal Plate Current	62	mA
Maximum Signal Plate Current	74	mA
Zero-Signal Grid-No.2 Current	8.2	mA
Maximum-Signal Grid-No.2 Current	16.5	mA
Load Resistance	2500	ohms
Total Harmonic Distortion (Approx.)	15	per cent
Maximum-Signal Power Output	9	watts
Grid-No.1 Voltage (Approx.) for plate current of 500 $\mu$ A	-36	volts

#### MAXIMUM CIRCUIT VALUES

Grid-No.1-Circuit Resistance:		
For fixed-bias operation	0.3	megohm
For cathode-bias operation	1	megohm

\* Grid-No.2 input may reach 7 watts during peak levels of speech and music signals.

### Push-Pull Class AB<sub>1</sub> Amplifier

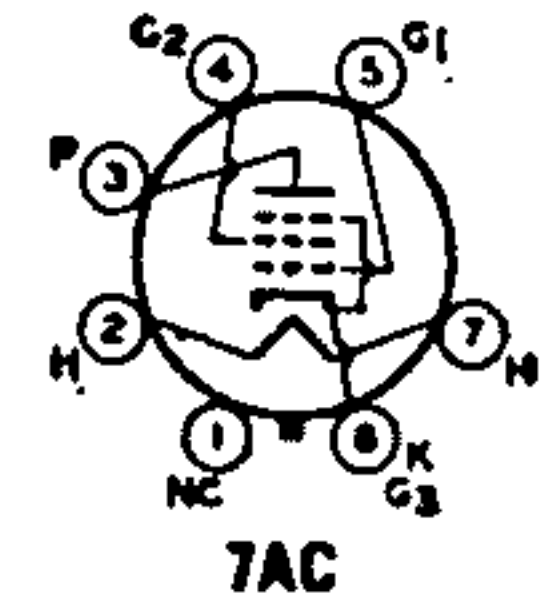
#### MAXIMUM RATINGS (Same as for class A<sub>1</sub> amplifier)

#### TYPICAL OPERATION (Values are for two tubes)

Plate Voltage	200	400	volts
Grid-No.2 Voltage	250	300	volts
Grid-No.1 Voltage	-21	-34	volts
Peak AF Grid-No.1 Voltage	42	60	volts
Zero-Signal Plate Current	100	66	mA
Maximum-Signal Plate Current	186	175	mA
Zero-Signal Grid-No.2 Current	5.5	8.5	mA
Maximum-Signal Grid-No.2 Current	24	24	mA
Effective Load Resistance (Plate-to-plate)	4000	5000	ohms
Total Harmonic Distortion	2	6	per cent
Maximum-Signal Power Output	28.5	40	watts

## 7408 BEAM POWER TUBE

Glass octal type used as outp. amplifier tube in high-quality sound systems. Outlines section, 13D; requires octal socket.



Heater Voltage (ac/dc)	6.3	volts
Heater Current	0.46	ampere
Heater-Cathode Voltage:		
Peak value	$\pm 200$	volts
Average value	100	volts



Direct Interelectrode Capacitances:

Grid No.1 to Plate .....	0.7	pF
Grid No.1 to Cathode, Heater, Grid No.2, and Grid No.3 .....	9	pF
Plate to Cathode, Heater, Grid No.2, and Grid No.3 .....	7.5	pF

**Class A<sub>1</sub> Amplifier**

**MAXIMUM RATINGS (Design-Maximum Values)**

Plate Voltage .....	350	volts
Grid-No.2 (Screen-Grid) Voltage .....	315	volts
Grid-No.2 Input .....	2.2	watts
Plate Dissipation .....	14	watts

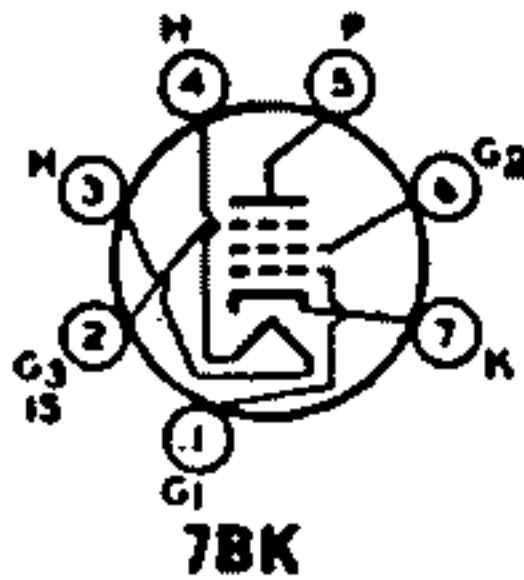
**TYPICAL OPERATION AND CHARACTERISTICS**

Plate Voltage .....	60	250	volts
Grid-No.2 Voltage .....	250	250	volts
Grid-No.1 (Control-Grid) Voltage .....	0	-12.5	volts
Peak AF Grid-No.1 Voltage .....	—	12.5	volts
Zero-Signal Plate Current .....	100*	45	mA
Maximum-Signal Plate Current .....	—	47	mA
Zero-Signal Grid-No.2 Current .....	22*	4.5	mA
Maximum-Signal Grid-No.2 Current .....	—	7	mA
Plate Resistance (Approx.) .....	—	60000	ohms
Transconductance .....	—	4100	μmhos
Load Resistance .....	—	5000	ohms
Total Harmonic Distortion .....	—	7	per cent
Maximum-Signal Power Output .....	—	4.5	watts

**MAXIMUM CIRCUIT VALUES**

Grid-No.1-Circuit Resistance:		
For fixed-bias operation .....	0.1	megohm
For cathode-bias operation .....	0.5	megohm

\* This value can be measured by a method involving a recurrent waveform such that the maximum ratings of the tube will not be exceeded.



**SHARP-CUTOFF PENTODE 7543**

Miniature type used in compact audio equipment. Outlines section, 5C; requires miniature 7-contact socket. This type is identical with miniature type 6AU6A except that it has a controlled hum characteristic.

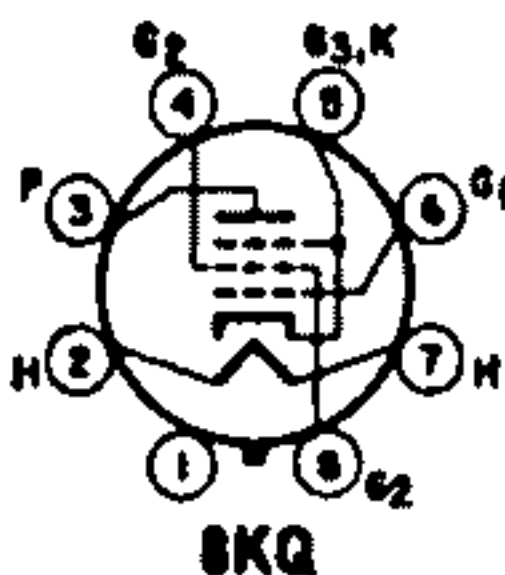
**HUM OUTPUT VOLTAGE**

Average Value, (rms, cathode bypassed) .....	1.2†	millivolts
Average Value (rms, cathode unbypassed) .....	0.9*	millivolt

† Measured in "true rms" units under the following conditions: heater volts (ac), 6.3; center tap of heater transformer connected to ground; plate and grid-No.2 supply volts, 250; plate load resistor, 0.27 megohm; grid No.3 and internal shield connected to cathode at socket; grid-No.2 resistor, 0.68 megohm; grid-No.1 resistor, 0.1 megohm; cathode resistor, 1000 ohms; grid resistor of following stage, 10 megohms; and stage gain, 340.

\* Same conditions as above except that cathode resistor is unbypassed and stage gain is 110.

Refer to chart at end of section. **7591**



**POWER PENTODE 7591A**

Glass octal type used as audio-frequency power-output tube in high-quality audio applications. Outlines section, 13D; require octal socket. Heater: volts (ac/dc), 6.3; amperes, 0.8; maximum heater-cathode volts, ±200 peak, 100 average.

**Class A<sub>1</sub> Amplifier**

**MAXIMUM RATINGS (Design-Maximum Values)**

Plate Voltage .....	550	volts
Grid-No.2 (Screen-Grid) Voltage .....	440	volts
Cathode Current .....	90	mA
Plate Dissipation .....	19	watts
Grid-No.2 Input .....	3.3*	watts

**TYPICAL OPERATION AND CHARACTERISTICS**

Plate Voltage .....	300	volts
Grid-No.2 Voltage .....	300	volts
Grid-No.1 (Control-Grid) Voltage .....	-10	volts
Peak AF Grid-No.1 Voltage .....	10	volts
Zero-Signal Plate Current .....	60	mA
Maximum-Signal Plate Current .....	75	mA
Zero-Signal Grid-No.2 Current .....	8	mA
Maximum-Signal Grid-No.2 Current .....	15	mA
Triode Amplification Factor* .....	16.8	
Plate Resistance (Approx.) .....	29000	ohms
Transconductance .....	10200	μmhos
Load Resistance .....	3000	ohms
Total Harmonic Distortion .....	13	per cent
Maximum-Signal Power Output .....	11	watts

**MAXIMUM CIRCUIT VALUES**

Grid-No.1-Circuit Resistance:		
For fixed-bias operation .....	0.3	megohm
For cathode-bias operation .....	1	megohm

\* Grid-No.2 input may reach 6 watts during peak levels of speech and music signals.

\* Triode connection, grid No.2 connected to plate.

**Push-Pull Class AB<sub>1</sub> Amplifier**

**MAXIMUM RATINGS (Same as for Class A<sub>1</sub> Amplifier)**

TYPICAL OPERATION (Values are for two tubes)	Fixed Bias	Cathode Bias	
Plate Supply Voltage .....	350	450	volts
Grid-No.2 Supply Voltage .....	350	400	volts
Grid-No.1 Supply Voltage .....	-15.5	-21	volts
Cathode-Bias Resistor (Common to both cathodes) .....	—	—	200 ohms
Peak AF Grid-No.1-to-Grid-No.1 Voltage .....	31	42	volts
Zero-Signal Plate Current .....	92	66	mA
Maximum-Signal Plate Current .....	130	144	mA
Zero-Signal Grid-No.2 Current .....	13	9.4	mA
Maximum-Signal Grid-No.2 Current .....	28.6	30	mA
Effective Load Resistance (Plate-to-plate) .....	6600	6600	9000 ohms
Total Harmonic Distortion .....	2	1.5	per cent
Maximum-Signal Power Output .....	30	45	28 watts

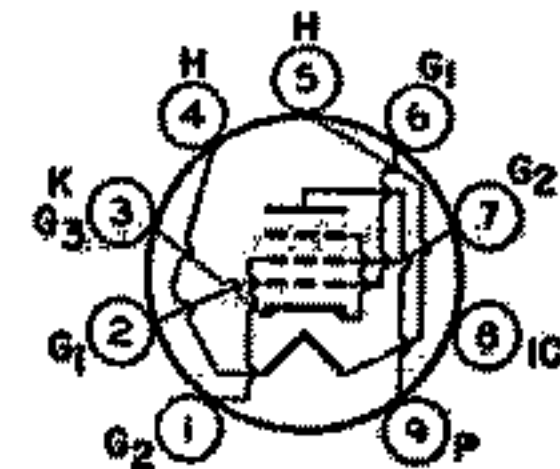
**7695**

Refer to chart at end of section.

**7868**

**POWER PENTODE**

Novar type used in output stages of high-fidelity audio amplifiers and radio receivers. Outlines section, 11C or 30D; requires novar 9-contact socket. This tube, like other power-handling tubes, should be adequately ventilated.



**9NZ**

Heater Voltage (ac/dc) .....	6.3	volts
Heater Current .....	0.8	ampere
Heater-Cathode Voltage:		
Peak value .....	±200 max	volts
Average value .....	100 max	volts
Direct Interelectrode Capacitances (Approx.):		
Grid No.1 to Plate .....	0.15	pF
Grid No.1 to Cathode, Heater Grid No.2, and Grid No.3 .....	11	pF
Plate to Cathode, Heater, Grid No.2, and Grid No.3 .....	4.4	pF

**Class A<sub>1</sub> Amplifier**

**MAXIMUM RATINGS (Design-Maximum Values)**

Plate Voltage .....	550*	volts
Grid-No.2 (Screen-Grid) Voltage .....	440	volts
Average Cathode Current .....	90	mA
Plate Dissipation .....	10	watts
Grid-No.2 Input .....	3.3*	watts
Bulb Temperature (At hottest point) .....	240	°C

**TYPICAL OPERATION AND CHARACTERISTICS**

Plate Supply Voltage .....	300	volts
Grid-No.2 Voltage .....	300	volts
Grid-No.1 (Control-Grid) Voltage .....	-10	volts
Peak AF Grid-No.1 Voltage .....	10	volts
Zero-Signal Plate Current .....	60	mA
Maximum-Signal Plate Current .....	75	mA
Zero-Signal Grid-No.2 Current .....	8	mA
Maximum-Signal Grid-No.2 Current .....	15	mA

Plate Resistance (Approx.) .....	29000	ohms
Transconductance .....	10200	$\mu$ mhos
Effective Load Resistance .....	8000	ohms
Total Harmonic Distortion .....	13	per cent
Maximum-Signal Power Output .....	11	watts

**MAXIMUM CIRCUIT VALUES**

Grid-No.1-Circuit Resistance:		
For fixed-bias operation .....	0.8	megohm
For cathode-bias operation .....	1	megohm

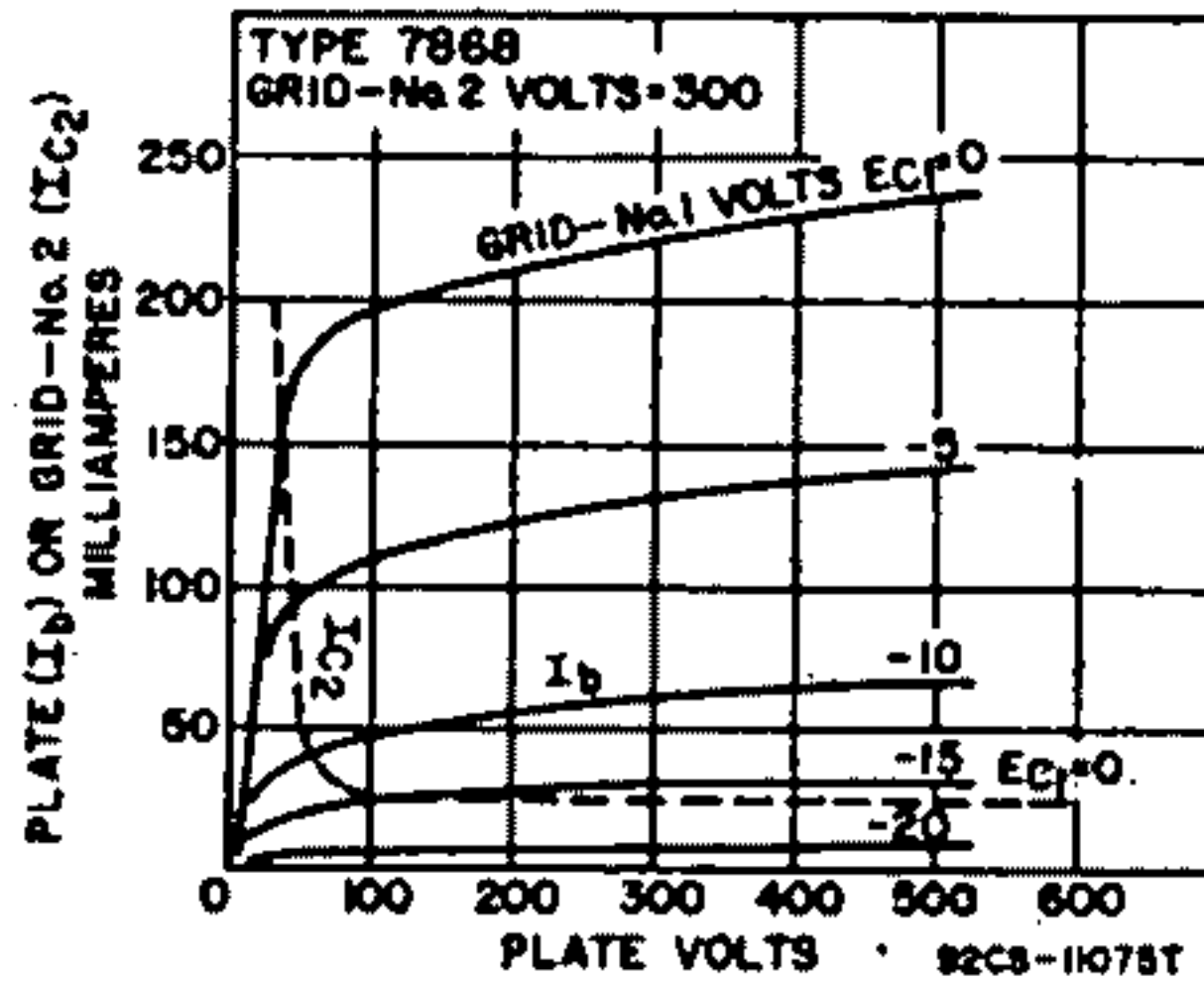
- \* In push-pull circuits where the grid No.2 of each tube is connected to a tap on the plate winding of the output transformer, this maximum rating is 440 volts.
- \* Grid No.2 input may reach 6 watts during peak levels of speech and music signals.

**Push-Pull Class AB<sub>1</sub> Amplifier**

MAXIMUM RATINGS (Same as for class A<sub>1</sub> amplifier)

TYPICAL OPERATION (Values are for two tubes)

	Fixed Bias					Cathode Bias	
Plate Supply Voltage .....	300	350	400	450	450	450	volts
Grid-No.2 Supply Voltage .....	300	350	350	350	400	400	volts
Grid-No.1 Voltage .....	-12.5	-15.5	-16	-16.5	-21	—	volts
Cathode-Bias Resistor (Common to both cathodes) .....	—	—	—	—	—	70	ohms
Peak AF Grid-No.1-to-Grid-No.1 Voltage .....	25	31	32	33	42	31	volts
Zero-Signal Plate Current .....	74	72	64	60	40	86	mA
Maximum-Signal Plate Current .....	116	130	135	142	145	94	mA
Zero-Signal Grid-No.2 Current .....	10	9.5	8	7.2	5	10	mA
Maximum-Signal Grid-No.2 Current .....	28	32	28	26	30	20	mA
Effective Load Resistance (Plate-to-plate) .....	6400	6600	6600	6600	6600	10000	ohms
Total Harmonic Distortion .....	5	2.5	2	2.5	5	2	per cent
Maximum-Signal Power Output .....	24	30	34	38	44	28	watts



**Push-Pull Class AB<sub>1</sub> Amplifier**

Grid No.2 of Each Tube Connected to Tap on Plate Winding of Output Transformer\*

MAXIMUM RATINGS (Same as for class A<sub>1</sub> amplifier)

TYPICAL OPERATION (Values are for two tubes)

	Fixed Bias	Cathode Bias	
Plate Supply Voltage .....	400	425	volts
Grid-No.2 Supply Voltage .....	*	*	volts
Grid-No.1 Voltage .....	-20.5	—	volts
Cathode-Bias Resistor (Common to both cathodes) ..	—	185	ohms
Peak AF Grid-No.1-to-Grid-No.1 Voltage .....	41	42	volts
Zero-Signal Plate Current .....	60	88	mA
Maximum-Signal Plate Current .....	115	100	mA
Zero-Signal Grid-No.2 Current .....	8	12	mA
Maximum-Signal Grid-No.2 Current .....	18	16	mA
Effective Load Resistance (Plate-to-plate) .....	6600	6600	ohms
Total Harmonic Distortion .....	2.5	3.5	per cent
Maximum-Signal Power Output .....	23	21	watts

\* Grid No.2 supply voltage is obtained from taps on the primary winding of the output transformer. The taps are located on each side of the center tap (B+) so as to apply 50 per cent of the plate signal voltage to the grid No.2 of each output tube.

Refer to chart at end of section.

EM84/6FG6



# RCA Types for

*Key to Chart:* Type numbers shown in light face are discontinued types. Outline numbers refer to diagrams shown in the Outlines section later in

RCA Type	Name	Outline	Base Diagram	Heater or Filament (F) Volts	Amperes	Use Values to right give operating conditions and characteristics for indicated typical use
8Z4	Full-Wave Gas Rectifier	2A	4R	—	—	Rectifier
OZ46	Full-Wave Gas Rectifier	280	4R	—	—	Rectifier
1A3	Diode	5C	5AP	1.4	0.15	Rectifier
1A4P	Remote-Cutoff Pentode	24B	4M	2.0F	0.06	Class A Amplifier
1A5GT	Power Pentode	130	6X	1.4F	0.05	Class A Amplifier
1A6	Pentagrid Converter	24B	6L	2.0F	0.06	Converter
1A7GT	Pentagrid Converter	14A	7Z	1.4F	0.05	Converter
1A65	Power Converter	28A	8CP	1.25F	0.04	Class A Amplifier
1A65	Sharp-Cutoff Pentode	28A	8CP	1.25F	0.04	Class A Amplifier
1A2	Half-Wave Rectifier	7A	8Y	1.4F	0.65	Pulsed Rectifier in TV Receivers
1B3GT	Half-Wave Rectifier	14E	3C	1.25F	0.2	Pulsed Rectifier in TV Receivers
1B4P	Sharp-Cutoff Pentode	24B	4M	2.0F	0.06	Class A Amplifier
1B5/25S	Twin Diode—Medium-Mu Triode	22 or 13M	6M	2.0F	0.06	Triode Unit as Class A Amplifier
1B7GT	Pentagrid Converter	14A	7Z	1.4F	0.10	Converter
1C5GT	Power Pentode	130	6X	1.4F	0.10	Class A Amplifier
1C6	Pentagrid Converter	24B	6L	2.0F	0.12	Converter
1C7G	Pentagrid Converter	23	7Z	2.0F	0.12	Converter
1D5GP	Remote-Cutoff Pentode	23	5Y	2.0F	0.06	Class A Amplifier
1D5GT	Remote-Cutoff Tetrode	23	5R	2.0F	0.06	Class A Amplifier
1D7G	Pentagrid Converter	23	7Z	2.0F	0.06	Converter
1D8GT	Diode-Triode-Power Pentode	14A	6AJ	1.4F	0.10	Pentode Unit as Class A Amplifier Triode Unit as Class A Amplifier
1D85	Diode—Semiremote-Cutoff Pentode	5C	68W	1.4F	0.5	Pentode Unit as Class A Amplifier

# Replacement Use

the Manual (see Table of Contents on inside front cover). Basing diagrams are included in numerical-alphabetical order at the end of the chart.

Plate Volts	Grid Bias or Cathode Resistor	Screen Grid Volts	Screen Grid Cur- rent mA	Plate Cur- rent mA	AC Plate Resist- ance, Ohms	Trans- conduct- ance Micromhos	Amplifi- cation Factor	Power		RCA Type
								Load Ohms	Out- put Watts	
Starting-Supply Voltage per Plate, 300 min. peak volts DC Output Current, 75 max., 30 min. mA							Peak Plate Current, 200 max. mA DC Output Voltage, 300 max. volts.			0Z4
Starting-Supply Voltage per Plate, 300 min. peak volts DC Output Current, 75 max., 30 min. mA							Peak Plate Current, 200 max. mA DC Output Voltage, 300 max. volts.			0Z4G
Max. Peak Plate Inverse Volts, 330 Max. Peak Plate mA, 5							Max. DC Output mA, 0.5 Max. Peak Heater-Cathode Volts, 140			1A3
For other characteristics, refer to Type 1D5GP										1A4P
85	— 4.5V	85	0.7	3.5	300000	800	—	25000	0.100	1A5GT
90	— 4.5V	90	1.1	4.0	300000	850	—	25000	0.115	
135	— 3V	67.5	2.5	1.2	400000	Anode-Grid (2): 180 max. volts 2.3 mA Oscillator-Grid (1) Resistor.				1A6
180	— 3V	67.5	2.4	1.3	500000	Anode-Grid (2): 90 volts, 1.2 mA Oscillator-Grid (1) Resistor, 0.2 MΩ Conversion Transcond., 250 micromhos				1A7GT
45	— 3V	45	0.2	1.0	170000	600	—	40000	0.015	1AC5
67.5	— 4.5V	67.5	0.4	2.0	150000	750	—	25000	0.050	
30	0V	30	0.16	0.45	700000	430	—	—	—	1AD5
67.5	0V	67.5	0.75	1.85	700000	735	—	—	—	
Max. Peak Inverse Plate Volts, 25000 Max. Peak Plate mA, 45							Max. Average Plate mA, 0.5			1AX2
Max. Peak Inverse Plate Volts, 26000 Max. Peak Plate mA, 50							Max. Average Plate mA, 0.5			1B3GT
For other characteristics, refer to Type 1E5GP										1B4P
For other characteristics, refer to Type 1H6G										1B5/ 25S
For other characteristics, refer to Type 1A7GT										1B7GT
90	— 7.5V	90	3.5	7.8	115000	1550	—	8000	0.24	1C5GT
For other characteristics, refer to Type 1C7G										1C6
135	— 3V	67.5	2.5	1.3	600000	Anode-Grid (2): 180 max. volts, 4.0 mA Oscillator-Grid (1) Resistor. Conversion Transcond., 325 micromhos.				1C7G
180	— 3V	67.5	2.0	1.5	700000					
90	{ — 3V min. }	67.5	0.9	2.2	600000	720	—	—	—	1D5GP
180		67.5	0.8	2.3	1 M	750	—	—	—	
For other characteristics, refer to Type 1D5GP										1D5GT
For other characteristics, refer to Type 1A6										1D7G
90	— 9V	90	1.0	5.0	—	925	—	12000	0.200	1D8GT
90	0V	—	—	1.1	43500	575	25	—	—	
67.5	0V	67.5	0.55	2.1	600000	630	—	—	—	1D95

RCA Type	Name	Out- line	Basing Dia- gram	Heater or Filament (F)		Use Values to right give operat- ing conditions and character- istics for indicated typical use
				Volts	Amperes	
1E5GP	Sharp-Cutoff Pentode	23	5Y	2.0F	0.06	Class A Amplifier
1E7GT	Twin Power Pentode	13D	8C	2.0F	0.24	Class A Amplifier
1E8	Pentagrid Converter	28A	8CN	1.25F	0.04	Converter
1F4	Power Pentode	25	8K	2.0F	0.12	Class A Amplifier
1F5G	Power Amplifier Pentode	25	8X	2.0F	0.12	Class A Amplifier
1F6	Twin Diode—Sharp-Cutoff Pentode	23	8W	2.0F	0.06	Pentode Unit as Class A Amplifier
1F7G	Twin Diode—Sharp-Cutoff Pentode	23	7AF	2.0F	0.06	Pentode Unit as Class A Amplifier
1G4GT	Medium-Mu Triode	13D	5S	1.4F	0.05	Class A Amplifier
1G5G	Power Pentode	25	8X	2.0F	0.12	Class A Amplifier
1G6GT	High-Mu Twin Power Triode	13D	7AB	1.4F	0.10	Class B Amplifier
1H4G	Medium-Mu Triode	22	5S	2.0F	0.06	Class A Amplifier Class B Amplifier
1H5GT	Diode—High-Mu Triode	14A	5Z	1.4F	0.05	Triode Unit as Class A Amplifier
1H6G	Twin Diode—Medium-Mu Triode	22	7AA	2.0F	0.06	Triode Unit as Class A Amplifier
1J3	Half-Wave Rectifier	14E	3C	1.25F	0.2	Pulsed Rectifier in TV Receivers
1J5G	Power Pentode	25	8X	2.0F	0.12	Class A Amplifier
1J6G 1J6GT	Twin-Triode Amplifiers	22 13F	7AB	2.0F	0.24	Class B Amplifier
1K3	Half-Wave Rectifier	14B	3C	1.25F	0.2	Pulsed Rectifier in TV Receivers
1L6	Pentagrid Converter	5C	7DC	1.4F	0.05	Converter
1LA4	Power Pentode	12B	5AD	1.4F	0.05	Amplifier
1LA6	Pentagrid Converter	12B	7AK	1.4F	0.05	Converter
1LB4	Power Pentode	12B	5AD	1.4F	0.05	Class A Amplifier
1LC5	Sharp-Cutoff Pentode	12B	7AB	1.4F	0.05	Class A Amplifier
1LC6	Pentagrid Converter	12B	7AK	1.4F	0.05	Converter
1LD5	Diode—Sharp-Cutoff Pentode	12B	6AX	1.4F	0.05	Pentode Unit as Class A Amplifier
1LE3	Medium-Mu Triode	12B	4AA	1.4F	0.05	Class A Amplifier
1LG5	Remote-Cutoff Pentode	12B	7AB	1.4F	0.05	Class A Amplifier
1LH4	Diode—High-Mu Triode	12B	5AG	1.4F	0.05	Triode Unit as Class A Amplifier
1LN5	Sharp-Cutoff Pentode	12B	7AB	1.4F	0.05	Class A Amplifier
1N2A	Half-Wave Rectifier	18A	3C	1.25F	0.2	Pulsed Rectifier in TV Receivers
1N5GT	Sharp-Cutoff Pentode	14A	5Y	1.4F	0.05	Class A Amplifier
1N6G	Diode—Power Pentode	28A	7AM	1.4F	0.05	Pentode Unit as Class A Amplifier
1P5GT	Remote-Cutoff Pentode	14A	5Y	1.4F	0.05	Class A Amplifier
1Q5GT	Beam Power Tube	13D	6AF	1.4F	0.1	Class A Amplifier



Plate Volts	Grid Bias or Cathode Resistor	Screen Grid Volts	Screen Grid Current mA	Plate Current mA	AC Plate Resistance Ohms	Trans-conductance Micromhos	Amplification Factor	Power		RCA Type
								Load Ohms	Output Watts	
90	-3V	67.5	0.7	1.6	1 M	600	—	—	—	1E5GP
180	-3V	67.5	0.6	1.7	1.5 M	650	—	—	—	1E5GP
135	-7.5V	135	3.5	10.5	—	—	—	24000	0.575	1E7GT
45	0V	45	1.1	0.6	400000	Oscillator Grid (1) Resistor, 0.1 MΩ	—	—	—	1E8
67.5	0V	67.5	1.5	1.0	400000	Conversion Transcond., 150 micromhos	—	—	—	1E8
For other characteristics, refer to Type 1F5G										1F4
90	-3V	90	1.1	4.0	240000	1400	—	20000	0.11	1F5G
135	-4.5V	135	2.4	8.0	—	—	—	—	0.31	1F5G
For other characteristics, refer to Type 1F7G										1F6
180	-1.5V	67.5	0.7	2.2	—	—	—	—	—	1F7G
90	-6V	—	—	2.3	10700	825	8.8	—	—	1G4GT
90	-6V	90	2.5	8.5	133000	1500	—	8500	0.25	1G5G
135	-13.5V	135	2.5	9.7	160000	1550	—	9000	0.55	1G5G
90	0V	—	11	—	—	—	—	12000	0.350	1G6GT
180	-13.5V	—	—	3.1	10300	900	9.3	—	—	1H4G
157.5	-15V	—	—	1.0□	—	—	—	8000	2.1†	1H4G
90	0V	—	—	0.15	240000	275	65	—	—	1H5GT
135	-3V	—	—	0.8	35000	575	20	—	—	1H6G
Max. Peak Inverse Plate Volts, 26000 (Abs.)										1J3
Max. Peak Plate mA, 50										1J3
135	-16.5V	135	2.0	7.0	105000	950	—	13500	0.45	1J5G
135	0V	—	—	—	—	—	—	10000	2.1	1J6G
135	-3V	—	—	—	—	—	—	10000	1.9	1J6GT
Max. Peak Inverse Plate Volts, 26000 (Abs.)										1K3
Max. Peak Plate mA, 50										1K3
90	0V	45	0.6	0.5	650000	Anode-Grid (2): 90 max. volts, 1.2 mA Oscillator Grid (1) Resistor, 0.2 MΩ Conversion Transcond., 300 micromhos	—	—	—	1L8
For other characteristics, refer to Type 1A5GT										1LA4
90	0V	65	0.6	0.55	750000	Total Cathode mA, 4 Conversion Transcond. (for grid-No. 4 bias of -3 volts), 10 micromhos	—	—	—	1LA6
For other characteristics, refer to Pentode Unit of Type 1D8GT										1LB4
45	0V	45	0.35	1.10	700000	750	—	—	—	1LC5
90	0V	45	0.30	1.15	1 M	775	—	—	—	1LC5
45	0V	35	0.75	0.70	300000	Anode-Grid (2): 50 max. volts, 1.4 mA Oscillator-Grid (1) Resistor, 0.2 MΩ Conversion Transcond., 275 micromhos	—	—	—	1LC6
90	0V	35	0.70	0.75	650000	—	—	—	—	1LC6
90	0V	45	0.1	0.6	750000	575	—	—	—	1LD5
90	0V	—	—	4.5	11200	1300	14.5	—	—	1LE3
90	-3V	—	—	1.4	19000	760	14.5	—	—	1LE3
90	0V	45	0.4	1.7	1 M	800	—	—	—	1LG5
90	-1.5V	90	0.9	3.7	500000	1150	—	—	—	1LG5
For other characteristics, refer to Type 1H5GT										1LH4
90	0V	90	0.35	1.6	1.1 M	800	—	—	—	1LN5
Max. Peak Inverse Plate Volts (Total DC and Peak), 28000										1N2A
Max. Peak Plate mA, 50										1N2A
90	0V	90	0.3	1.2	1.5 M	750	—	—	—	1N5GT
90	-4.5V	90	0.6	3.1	300000	800	—	25000	0.1	1N6G
90	0V	90	0.7	2.3	800000	750	—	—	—	1P5GT
110	-6.6V	110	1.4	10	100000	2200	—	8000	0.4	1Q5GT

† For two tubes at stated plate-to-plate load.

□ For two tubes.

RCA Type	Name	Out-line	Basing Diagram	Heater or Filament (F)		Use Values to right give operating conditions and characteristics for indicated typical use
				Volts	Amperes	
1R5	Pentagrid Converter	5C	7AT	1.4F	0.05	Converter
1S4	Power Pentode	5C	7AV	1.4F	0.1	Class A Amplifier
1S5	Diode—Sharp-Cutoff Pentode	5C	6AU	1.4F	0.05	Pentode Unit as AF Amplifier
1T4	Remote-Cutoff Pentode	5C	6AR	1.4F	0.05	Class A Amplifier
1T5GT	Beam Power Tube	13D	6X	1.4F	0.05	Class A Amplifier
1T6	Diode—Sharp-Cutoff Pentode	29A	6DA	1.25F	0.04	Pentode Unit as Class A Amplifier
1D4	Sharp-Cutoff Pentode	5C	6AR	1.4F	0.05	Class A Amplifier
1D5	Diode—Sharp-Cutoff Pentode	5C	6BW	1.4F	0.05	Pentode Unit as Class A Amplifier
1V	Half-Wave Rectifier	22 or 13H	4G	6.3	0.3	With Capacitive-Input Filter
1X2A	Half-Wave Rectifier	7A	8Y	1.25F	0.2	Pulsed Rectifier in TV Receivers Class A Amplifier
2A3	Power Triode	27B	4D	2.5F	2.5	Push-Pull Class AB <sub>1</sub> Amplifier
2A5	Power Pentode	28	6B	2.5	1.75	Amplifier
2A6	Twin Diode—High-Mu Triode	24B	6B	2.5	0.8	Triode Unit as Amplifier
2A7	Pentagrid Converter	24B	7C	2.5	0.8	Converter
2AF4A	Medium-Mu Triode	5B	7BK	2.35	0.6	Class A Amplifier
2B7	Twin Diode—Remote-Cutoff Pentode	24B	7D	2.5	0.8	Pentode Unit as Amplifier
2BN4	Medium-Mu Triode	5C	7EG	2.3	0.6	Class A Amplifier
2E5	Electron-Ray Tube	22 or 13H	6R	2.5	0.8	Visual-Indicator
2EN5	Twin Diode	5C	7FL	2.1	0.45	Horizontal Phase Detector
3A2	Half-Wave Rectifier	7A	90T	3.15	0.22	Pulsed Rectifier in TV Receivers
3A3	Half-Wave Rectifier	14E	9EZ	3.15	0.22	Pulsed Rectifier in TV Receivers
3A8GT	Diode-Triode—Pentode	29G	8AS	1.4F 2.8F	0.1 0.05	Triode Unit as Class A Amplifier Pentode Unit as Class A Amplifier
3B2	Half-Wave Rectifier	21C	86H	3.15	0.22	Pulsed Rectifier in TV Service
3BC5	Sharp-Cutoff Pentode	5C	7BD	3.15	0.6	Class A Amplifier
3BN4	Medium-Mu Triode	5C	7EG	3.0	0.45	Class A Amplifier
3DT6	Sharp-Cutoff Pentode	5C	7EM	3.15	0.6	Class A Amplifier
3EA5	Sharp-Cutoff Tetrode	5C	7EW	2.9	0.45	Class A Amplifier
3GS8/ 3B8B	Sharp-Cutoff Twin Pentode	8E	9LW	3.15	0.6	Class A Amplifier (With both sections operating)
3HA5	High-Mu Triode	5A	7GM	2.7	0.45	Class A Amplifier
3LF4	Beam Power Tube	12B	6BA	1.4F 2.8F	0.1 0.05	Class A Amplifier
3Q4	Power Pentode	5C	7BA	1.4F 2.8F	0.1 0.05	Class A Amplifier
3Q5GT	Beam Power Tube	13D	7AP	1.4F 2.8F	0.1 0.05	Class A Amplifier

Plate Volts	Grid Bias or Cathode Resistor	Screen Grid Volts	Screen Grid Current mA	Plate Current mA	AC Plate Resistance Ohms	Trans-conductance Micromhos	Amplification Factor	Power		RCA Type
								Load Ohms	Output Watts	
45 90	0V 0V	45 67.5	2.1 3.5	0.7 1.5	500000 400000	Conversion Transcond., 210 $\mu$ hos Conversion Transcond., 280 $\mu$ hos	—	210 280	—	1R5
45 90	— 4.5V — 7V	45 67.5	0.8 1.4	3.8 7.4	100000 100000	1250 1575	—	8000 8000	0.065 0.27	1S4
Plate Supply, 90 V applied through 1 M $\Omega$ resistor. Screen Supply, 90 V applied through 3.1 M $\Omega$ resistor. Grid Bias, 0 volts. Grid Resistor, 10 megohms. Voltage Gain, 66 approx.										1S5
45 90	0V 0V	45 67.5	0.7 1.4	1.7 3.5	350000 500000	700 900	—	—	—	1T4
90	— 6V	90	0.8	6.5	250000	1150	—	14000	0.17	1T5GT
45 67.5	0V 0V	45 67.5	0.21 0.4	0.75 1.6	500000 400000	475 600	—	—	—	1T6
90	0V	90	0.50	1.1	1 M	900	—	—	—	1U4
67.5	0V	67.5	0.4	1.6	500000	625	—	—	—	1U5
Max. AC Plate Volts (RMS), 325 Max. DC Output mA, 45										1V
Min. Total Effective Plate-Supply Impedance: Up to 117 volts, 0 ohms; at 150 volts, 30 ohms; at 325 volts, 75 ohms										
Max. Peak Inverse Plate Volts, 20000 Max. Peak Plate mA, 45										1X2A
250	—45V	—	—	60.0	800	5250	4.2	2500	3.5	2A3
300 300	780 $\Omega$ —82V	—	—	80.0 $\square$ 80.0 $\square$	—	—	—	5000 3000	10.0 $\dagger$ 15.0 $\dagger$	
For other characteristics, refer to Type 6F6G										2A5
For other characteristics, refer to Type 6SQ7										2A6
For other characteristics, refer to Type 6A8										2A7
80	150 $\Omega$	—	—	17.5	2100	6500	13.5	—	—	2AF4A
For other characteristics, refer to Type 6B8G										2B7
150	220 $\Omega$	—	—	9	6300	6800	43	—	—	2BN4
For other characteristics, refer to Type 6E5										2E5
Max. Peak Heater-Cathode Volts, $\pm$ 200 DC Volts Not to Exceed +100										2EN5
Max. DC Plate mA, 5										
Max. Peak Inverse Plate Volts, 18000 Max. Peak Plate mA, 80										3A2
Max. Peak Inverse Plate Volts, 30000 Max. Peak Plate mA, 88										3A3
90	0V	—	—	0.2	200000	325	65	—	—	3A8GT
90	0V	90	0.5	1.5	800000	750	—	—	—	
Max. Peak Plate mA, 80 Max. Total DC & Peak Inverse Plate Volts, 35000 (Abs.)										3B2
Max. DC Inverse Plate Volts, 25000 Max. Average Plate mA, 1.1										
100 250	180 $\Omega$	100 150	1.4 2.1	4.7 7.5	600000 800000	4900 5700	—	—	—	3BC5
For other characteristics, refer to Type 6BN4										3BN4
150	56 $\Omega$	100	2.1	1.1	150000	515	—	—	—	3DT6
250	—1V	140	0.95	10	150000	8000	—	—	—	3EA5
For other characteristics, refer to Type 4GS8/4BU8										3GS8/ 3BU8
135	87 $\Omega$	—	10	19 11.5	1000 5600	20000 14500	80 72	—	—	3HA5
For other characteristics, refer to Type 3Q5GT										3LF4
For other characteristics, refer to Type 3V4										3Q4
110 110	— 6.6V — 6.6V	110 110	1.4 1.1	10.0 8.5	100000 110000	2200 2000	—	8000 8000	0.40 0.33	3Q5GT

$\dagger$  For two tubes at stated plate-to-plate load.

$\square$  For two tubes.



RCA Type	Name	Out-line	Biasing Diagram	Heater or Filament (F)		Use Values to right give operating conditions and characteristics for indicated typical use
				Volts	Amperes	
3S4	Power Pentode	5C	7BA	1.4F 2.8F	0.1 0.05	Class A Amplifier
3V4	Power Pentode	5C	6BX	1.4F 2.8F	0.1 0.05	Class A Amplifier
4BC5	Sharp-Cutoff Pentode	5C	7BB	4.2	0.45	Class A Amplifier
4DT6	Sharp-Cutoff Pentode	5C	7EN	4.2	0.45	Class A Amplifier
4CS8	Sharp-Cutoff Pentode	6E	9LW	4.2	0.45	Class A Amplifier
4CS8/ 4BB8	Sharp-Cutoff Twin Pentode	6E	9LW	4.2	0.45	Class A Amplifier (With both sections operating)
5AS4	Full-Wave Rectifier	27A	5T	5.0F	3.0	With Capacitive-Input Filter
5AU4	Full-Wave Rectifier	19G	5T	5.0F	3.75	With Capacitive-Input Filter With Inductive-Input Filter
5AW4	Full-Wave Rectifier	19H	5T	5.0F	3.7	Rectifier
5AZ4	Full-Wave Rectifier	12C	5T	5.0F	2.0	
5BE8	Medium-Mu Triode—Sharp-Cutoff Pentode	6B	9EG	4.7	0.6	Triode Unit as Class A Amplifier Pentode Unit as Class A Amplifier
5BT8	Twin-Diode—Sharp-Cutoff Pentode	6B	9FE	4.7	0.6	Class A Amplifier
5CL8	Medium-Mu Triode—	6B	9FX	4.7	0.6	Triode Unit as Class A Amplifier
5CM8	High-Mu Triode—Sharp-Cutoff Pentode	6B	9FZ	6.3	0.45	Triode Unit as Class A Amplifier Pentode Unit as Class A Amplifier
5DH8	High-Mu Triode—Sharp-Cutoff Pentode	6B	9EG	5.2	0.6	Triode Unit as Class A Amplifier Pentode Unit as Class A Amplifier
5T4	Full-Wave Rectifier	4	5T	5.0F	2.0	With Capacitive-Input Filter With Inductive-Input Filter
5B4G	Full-Wave Rectifier	27B	5T	5.0F	3.0	With Capacitive-Input Filter
5Y3	Full-Wave Rectifier	19E	5T	5.0F	3.0	With Capacitive-Input Filter With Inductive Input Filter
5W4 5W4GT	Full-Wave Rectifier	2B 13E	5T 5T	5.0F	1.5	With Capacitive-Input Filter
5X4G	Full-Wave Rectifier	27D	5Q	5.0F	3.0	
5Y3G	Full-Wave Rectifier	25	5T	5.0F	2.0	With Capacitive-Input Filter
5Y4G 5Y4GA 5Y4GT	Full-Wave Rectifier	25 19E 13E	5Q 5Q 5Q	5.0F	2.0	
5Z3	Full-Wave Rectifier	27D	4C	5.0F	3.0	
5Z4	Full-Wave Rectifier	2B	5L	5.0	2.0	With Capacitive-Input Filter With Inductive-Input Filter
6A3	Power Triode	27B	4B	6.3F	1.0	Amplifier
6A6	High-Mu Twin Power Triode	2B	7B	6.3	0.8	Amplifier

Plate Volts	Grid Bias or Cathode Resistor	Screen Grid Volts	Screen Grid Cur- rent mA	Plate Cur- rent mA	AC Plate Resist- ance Ohms	Trans- conduct- ance Micromhos	Amplifi- cation Factor	Power		RCA Type
								Load Ohms	Out- put Watts	
90	— 7V	67.5	1.4	7.4	100000	1575	—	8000	0.27	3S4
90	— 7V	67.5	1.1	6.1	100000	1425	—	8000	0.235	
90	— 4.5V	90	2.1	9.5	100000	2150	—	10000	0.27	3V4
90	— 4.5V	90	1.7	7.7	120000	2000	—	10000	0.24	
250	180Ω	150	2.1	7.5	800000	5700	—	—	—	4BC5
150	56Ω	100	2.1	1.1	150000	515	—	—	—	4DT6
For other characteristics, refer to Type 4GS8/4BU8										4GS8
100	:	67.5	6.0	—	Grid-No. 3 volts, each section, —10			—	—	4GS8/ 4BU8
100	:	67.5	3.6	2.0	Grid-No. 3 volts, each section, 0			—	—	
: Grid current adjusted for 100 microamperes DC										
Max. AC Volts per Plate (RMS), 550				Max. DC Output mA, 300			Min. Total Effect. Supply			5AS4
Max. Peak Inverse Volts, 1550				Max. Peak Plate mA, 1000			Imped. per Plate, 97 ohms			
Max. DC Output mA, 325 for AC Volts per Plate, 400						Max. Peak Inverse Volts, 1400				5AU4
and Total Effect. Supply Imped. per Plate, 50 ohms						Max. Peak Plate mA per Plate, 1075				
Max. DC Output mA, 325 for AC Volts per Plate, 500 and Input Choke 10 henries						Max. Peak Plate mA per Plate, 1075				5AW4
Max. Peak Inverse Volts, 1400						Max. Peak Plate mA per Plate, 750				
For ratings and characteristics, refer to Type 5Y3GT										5AZ4
150	56Ω	—	—	18	5000	8500	40	—	—	5BE8
250	68Ω	110	3.5	10	400000	5200	—	—	—	5BT8
200	180Ω	150	2.8	9.5	300000	6200	—	—	—	5CL8
125	— 1V	—	—	14	5000	8000	40	—	—	5CM8
For other characteristics, refer to 6CM8										5DH8
250	390Ω	—	—	7.3	12000	4400	53	—	—	5T4
125	56Ω	125	3.8	13.5	150000	8600	—	—	—	
Max. AC Volts per Plate (RMS), 450				Max. DC Output mA, 225			Min. Total Effect. Supply			5U4G
Max. Peak Inverse Volts, 1550				Max. Peak Plate mA, 675			Imped. per Plate, 150 ohms			
Max. AC Volts per Plate (RMS), 550				Max. DC Output mA, 225			Min. Value of Input Choke,			5U4G
Max. Peak Inverse Volts, 1550				Max. Peak Plate mA, 675			10 henries			
Max. AC Volts per Plate (RMS), 450				Max. DC Output mA, 225			Min. Total Effect. Supply			5V3
Max. Peak Inverse Volts, 1550				Max. Peak Plate mA, 675			Imped. per Plate, 170 ohms			
Max. AC Volts per Plate (RMS), 425				Max. DC Output mA, 350			Max. Peak Plate mA per Plate, 1200			5W4 5W4GT
Max. Peak Inverse Volts, 1400				Min. Total Effect. Supply Imped. per Plate, 56 ohms			Max. Peak Plate mA per Plate, 1200			
Max. AC Volts per Plate (RMS), 500				Max. DC Output mA, 350			Max. Peak Plate mA per Plate, 1200			5X4G
Max. Peak Inverse Volts, 1400				Min. Value of Input Choke, 10 henries			Max. Peak Plate mA, 300			
For other ratings, refer to Type 5U4G										5Y3G
Max. AC Volts per Plate (RMS), 350				Max. DC Output mA, 125			Min. Total Effect. Supply			5Y4G 5Y4GA 5Y4GT
Max. Peak Inverse Volts, 1400				Max. Peak Plate mA, 440			Imped. per Plate, 50 ohms			
Max. Peak Plate mA, 375 (5Y4G)						For other ratings, refer to Type 5Y3G				5Z3
Max. Peak Plate mA, 400 (5Y4GA, 5Y4GT)						For other ratings, refer to Type 5U4G				
For other ratings, refer to Type 5U4G										5Z4
Max. AC Volts per Plate (RMS), 350				Max. DC Output mA, 125			Min. Total Effect Supply			6A3
Max. Peak Inverse Volts, 1400				Max. Peak Plate mA, 375			Imped. per Plate, 50 ohms			
Max. AC Volts per Plate (RMS), 500				Max. DC Output mA, 125			Min. Value of Input Choke,			6A6
Max. Peak Inverse Volts, 1400				Max. Peak Plate mA, 375			5 henries			
For other characteristics, refer to Type 6B4G										
For other characteristics, refer to Type 6N7GT										

RCA Type	Name	Out-line	Basing Diagram	Heater or Filament (F)		Use Values to right give operating conditions and characteristics for indicated typical use
				Volts	Amperes	
6A7 6A7S	Pentagrid Converter	24B 24B	7C	6.3	0.3	Converter
6AB 6ABG 6ABGT	Pentagrid Converter	3 23 14A	8A 8A 8A	6.3	0.3	Converter
6AB5/ 6N5	Electron-Ray Tube	22 or 13H	8B	6.3	0.15	Visual Indicator
6AB7	Sharp-Cutoff Pentode	2A	8M	6.3	0.45	Class A Amplifier Class B Amplifier
6AC5GT	High-Mu Power Triode	13D	8Q	6.3	0.4	Dynamic-Coupled Amplifier With 76 Driver
6AC7	Sharp-Cutoff Pentode	2A	8N	6.3	0.45	Class A Amplifier
6AD6G	Electron-Ray Tube	29E	7AG	6.3	0.15	Visual Indicator
6AD7G	Low-Mu Triode—Power Pentode	25	8AY	6.3	0.85	Triode Unit as Class A Amplifier Pentode Unit as Class A Amplifier
6AE5GT	Low-Mu Triode	13D	8Q	6.3	0.3	Class A Amplifier
6AE6G	Twin-Plate Control Tube	22	7AM	6.3	0.15	Remote Cutoff Triode Sharp-Cutoff Triode
6AE7GT	Twin-Input Triode	13D	7AX	6.3	0.5	Class A Amp.
6AN4GT	Low-Mu Triode	13D	8EL	6.3	0.75	Vertical Deflection Amplifier
6AN6	Sharp-Cutoff Pentode	5C	7BX	6.3	0.45	Class A Amplifier
6AL7GT	Electron-Ray Tube	13C	8CM	6.3	0.15	Visual Indicator
6AM4	High-Mu Triode	6A	8BX	6.3	0.225	Class A Amplifier
6AM8	Diode—Sharp-Cutoff Pentode	8B	9CY	6.3 6.3	0.45 0.45	Diode Unit Pentode Unit as Class A Amplifier
6AN8	Medium-Mu Triode—Sharp-Cutoff Pentode	8B	9DA	6.3 6.3	0.45 0.45	Triode Unit as Class A Amplifier Pentode Unit as Class A Amplifier
6AQ5	Beam Power Tube	5B	7BZ	6.3 6.3	0.45 0.45	Single Tube Class A Amplifier Push-Pull Class A Amplifier
6AQ6	Twin-Diode—High-Mu Triode	5C	7BT	6.3	0.15	Triode Unit as Class A Amplifier
6AQ7GT	Twin-Diode—High-Mu Triode	13D	8CK	6.3	0.3	Triode Unit as Class A Amplifier
6AR5	Power Pentode	5B	8CC	6.3	0.4	Class A Amplifier
6AS11	Dual Triode—Sharp-Cutoff Pentode	8B	12DP	6.3	1.05	Dual Triode Unit as Class A Amplifier Pentode Unit as Class A Amplifier
6AT8	Medium-Mu Triode—	8B	9BW	6.3	0.45	Triode Unit as Class A Amplifier
6AU4GT	Half-Wave Rectifier	13G	4CG	6.3	1.8	Television Damper Service
6AU6	Sharp-Cutoff Pentode	5C	7BK	6.3 6.3	0.3 0.3	Class A Amplifier



Plate Volts	Grid Bias of Cathode Resistor	Screen Grid Volts	Screen Grid Current mA	Plate Current mA	AC Plate Resistance Ohms	Trans-conductance Micromhos	Amplification Factor	Power		RCA Type
								Load Ohms	Output Watts	
For other characteristics, refer to Type 6A8										
250	-3V	100	2.7	3.5	360000	Anode-Grid (2): 250 max. V, 4.0 mA Oscillator-Grid (1) Res. Conversion Transcond., 550 $\mu$ mhos				6A7 6A7S 6A8 6A8G 6A8GT
Plate & Target Supply = 135 volts. Triode Plate Resistor = 0.25 M $\Omega$ Target Current = 2.0 mA Grid Bias, -10.0 volts; Shadow Angle, 0°. Bias, 0 volts; Angle, 90°; Plate Current, 0.5 mA.										
Plate & Target Supply = 135 volts. Triode Plate Resistor = 1.0 M $\Omega$ Target Current = 1.9 mA Grid Bias, -15.5 volts; Shadow Angle, 0°. Bias, 0 volts; Angle, 90°; Plate Current, 0.13 mA										
300	-3V	200	3.2	12.5	700000	5000	—	—	—	6A8T
250	0V	—	—	5.0 $\square$	—	—	—	10000	8.0 $\dagger$	
250	Bias for both 6AC5GT and 76 is developed in coupling circuit Average Plate Current of Driver = 5.5 milliamperes Average Plate Current of 6AC5GT = 32 milliamperes							7000	3.7	6AC5GT
300	160 $\Omega$	150	2.5	10.0	1 M	9000	—	—	—	6AC7
Target Voltage, 150 volts. Control-Electrode Voltage, -50 volts; Shadow Angle, 135°; Target Current, 1.2 mA Control-Electrode Voltage, 75 volts; Angle, 0°; Target Current, 3 mA										
250	-25V	—	—	3.7	19000	325	6	—	—	6AD6G
250	-16.5V	250	6.5	34.0	80000	2500	—	7000	3.2	6AD7G
95	-15V	—	—	7.0	3500	1200	4.2	—	—	6AE5GT
250	-1.5V	—	—	6.5	25000	1000	25	—	—	
250	-35V	—	—	0.01	—	—	—	—	—	6AE6G
250	-1.5V	—	—	4.5	35000	950	33	—	—	
250	-9.5V	—	—	0.01	—	—	—	—	—	
250	-13.5V	—	—	10.0	4650	3000	14	—	—	6AE7GT
Max. DC Plate Volts, 500 Max. DC Cathode mA, 60										
Max. Peak Positive-Pulse Plate Volts, 2000 Max. Plate Dissipation, 7.5 watts										
300	160 $\Omega$	150	2.5	10.0	500000	9000	—	—	—	6AN6
Target Voltage, 315 volts Grid Voltage = 0 volts Cathode Bias Res., 3300 ohms approx.										
Grid Voltage for Pattern Cutoff, -7 volts approx. Deflecting-Electrodes—No. 1, No. 2 and No. 3 Voltage, 0										
200	100 $\Omega$	—	—	10	8700	9800	85	—	—	6AM4
Max. DC Plate mA, 5 Max. Peak Heater-Cathode Volts, $\pm$ 200										
125	56 $\Omega$	125	3.2	12.5	—	7800	—	—	—	6AM8
150	-3V	—	—	15	4500	4700	31	—	—	
125	56 $\Omega$	125	3.8	12	170000	7800	—	—	—	6AN8
180	-8.5V	180	3.0	29.0	50000	3700	—	5500	2.0	
250	-12.5V	250	4.5	45.0	50000	4100	—	5000	4.5	6AQ5
250	-15V	250	5.0 $\square$	70.0 $\square$	60000	—	—	10000	10.0 $\dagger$	
100	-1V	—	—	0.8	61000	1150	70	—	—	6AQ8
250	-3V	—	—	1.0	58000	1200	70	—	—	
250	-2V	—	—	2.3	44000	1600	70	—	—	6AQ7GT
250	-18V	250	5.5	32.0	90000	2300	—	7600	3.4	6AR5
200	220 $\Omega$	—	—	9.2	4400	4400	41	—	—	
200	-2V	—	—	7	12400	5500	68	—	—	6AS11
200	125	125	5.2	24	70000	10500	—	—	—	
125	-1V	—	—	12	6000	6500	40	—	—	6AT8
Max. Peak Inverse Plate Volts, 4500 (Absolute) Max. Peak Plate mA, 1050										
Max. Average Plate mA, 175 Max. Plate Dissipation 6.0 watts										
100	150 $\Omega$	100	2.1	5.0	500000	3900	—	—	—	6AU4GT
250	68 $\Omega$	150	4.3	10.6	1 M	5200	—	—	—	6AU6

$\dagger$  For two tubes at stated plate-to-plate load.

$\square$  For two tubes.

RCA Type	Name	Out-line	Basing Diagram	Heater or Filament (F)		Use Values to right give operating conditions and characteristics for indicated typical use
				Volts	Amperes	
6AU7	Medium-Mu Twin Triode	6B	8A	3.15 6.3	0.6 0.3	Each Unit as Class A Amplifier
6AU8	Medium-Mu Triode—Sharp-Cutoff Pentode	8E	90X	6.3	0.6	Triode Unit as Class A Amplifier Pentode Unit as Class A Amplifier
6AY5GT	Beam Power Tube	13D	8CK	6.3	1.2	Horizontal Deflection Amplifier
6AW8	High-Mu Triode—Sharp-Cutoff Pentode	8E	99X	6.3	0.6	Triode Unit as Class A Amplifier Pentode Unit as Class A Amplifier
6AX4GT	Half-Wave Rectifier	13D	4CG	6.3	1.2	Television Damper Service
6AX8	Medium-Mu Triode—Semiremote Cutoff Pentode	8B	8AE	6.3	0.45	Triode Unit as Class A Amplifier Pentode Unit as Class A Amplifier
6AY11	Twin Diode—High-Mu Twin Triode	8A	12DA	6.3	0.69	Each Triode Unit as Class A Amplifier
6B4G	Power-Triode	27B	5S	6.3F	1.0	Class A Amplifier
6B5	Direct-Coupled Power Triode	26	8AS	6.3	0.8	Class A Amplifier
6B6G	Twin-Diode—High-Mu Triode	23	7V	6.3	0.3	Triode Unit as Amplifier
6B7 6B7S	Twin-Diode—Remote-Cutoff Pentode	24B 24B	7B	6.3	0.3	Pentode Unit as Amplifier
6B8	Twin-Diode—Semiremote-Cutoff Pentode	3	8E	6.3	0.3	Pentode Unit as Amplifier
6B8G	Twin Diode—Semiremote-Cutoff Pentode	23	8E	6.3	0.3	Pentode Unit as Class A Amplifier
6BD4	Sharp-Cutoff Beam Triode	21C	8FU	6.3	0.6	Voltage-Control
6BD4A	Sharp-Cutoff Beam Triode	21C	8FU	6.3	0.6	Voltage-Control
6B8G	Remote-Cutoff Pentode	5C	7BK	6.3	0.3	Class A Amplifier
6BF5	Beam Power Tube	5D	7BZ	6.3	1.2	Class A Amplifier
6BF6	Twin-Diode—Medium-Mu Triode	5C	7BT	6.3	0.3	Triode Unit as Class A Amplifier
6B6G 6B6GA	Beam Power Tube	20B 21B	5BT 5BT	6.3	0.9	Horizontal Deflection Amplifier
6BK4	Sharp-Cutoff Beam Triode	21B	8GC	6.3	0.2	Voltage-Control
6BK5	Beam Power Tube	6E	9BQ	6.3	1.2	Class A Amplifier
6BK7A	Medium-Mu Twin Triodes	6B	8AJ	6.3 6.3	0.45 0.45	Each Unit as Class A Amplifier
6BL4	Half-Wave Rectifier	13F	8GB	6.3	3.0	Television Damper Service
6BL7GT	Medium-Mu Twin Triode	13D	8BD	6.3	1.5	Vertical Deflection Amplifier
6BN4	Medium-Mu Triode	5C	7EG	6.3	0.2	Class A Amplifier
6BQ6GT	Beam Power Tube	14B	8AM	6.3	1.2	Horizontal Deflection Amplifier
6BQ7	Medium-Mu Twin Triode	6B	8AJ	6.3	0.4	Each Unit as Class A Amplifier
6BR8	Medium-Mu Triode—Sharp-Cutoff Pentode	6B	9FA	6.3 6.3	0.45 0.45	Triode Unit as Class A Amplifier Pentode Unit as Class A Amplifier
6BV8	Twin Diode—Medium-Mu Triode	6B	9FJ	6.3	0.6	Triode Unit as Class A Amplifier

Plate Volts	Grid Bias or Cathode Resistor	Screen Grid Volts	Screen Grid Current mA	Plate Current mA	AC Plate Resistance Ohms	Trans-conductance Micromhos	Amplification Factor	Power		RCA Type
								Load Ohms	Output Watts	
100	0V	—	—	11.8	6250	3500	18.5	—	—	6AU7
250	— 8.5V	—	—	10.5	7700	2200	17	—	—	
150	150Ω	—	—	9	8200	4900	40	—	—	6AU8
200	82Ω	125	3.4	15	150000	7000	—	—	—	
Max. DC Plate Volts, 550 Max. DC Cathode mA, 110				Max. Peak Positive-Pulse Plate Volts, 5500 (Abs.) Max. Plate Dissipation, 11 watts						6AV5GT
200	— 2V	—	—	4	—	4000	70	—	—	
150	150Ω	150	3.5	13	200000	9500	—	—	—	6AW8
6AW8A Features a plate current characteristic with a controlled knee										
Max. Peak Inverse Plate Volts, 4400 Max. Peak Plate mA, 750 Max. DC Plate mA, 125				Max. Peak Heater-Cathode Volts: $\begin{cases} -4400^{**} \\ +300 \end{cases}$ <small>**DC component must not exceed 900 volts</small>						6AX4GT
150	560Ω	—	—	18	5000	8500	40	—	—	
250	120Ω	110	3.5	10	400000	4800	—	—	—	6AX8
250	— 2V	—	—	1.2	52700	1900	100	—	—	6AY11
250	—45V	—	—	60	800	5250	4.2	2500	3.5	6B4G
For other characteristics, refer to Type 6N6G										6B5
For other characteristics, refer to Type 6SQ7										6B6G
Input Triode:		Plate Volts, 300 max; Grid Volts, 0; Plate mA, 8; AF Signal Volts (Peak), 21								6B7
Output Triode:		Plate Volts, 300 max.; Plate mA, 45; Plate Res., 24000 ohms; Load Resistance, 7000 ohms; Power Output, 4 watts								6B7S
For other characteristics, refer to Type 12C8										6B8
250	— 3V	125	2.3	9	600000	1125	—	—	—	6B8G
Max. DC Plate Volts, 20000 Max. Unregulated DC Supply Volts, 40000				Max. DC Plate mA, 1.5 Max. Plate Dissipation, 20.0 watts						6BD4
Max. DC Plate Volts, 27000 Max. Unregulated DC Supply Volts, 55000				Max. DC Plate mA, 1.5 Max. Plate Dissipation, 25.0 watts						
250	— 3V	100	3.0	9.0	800000	2000	—	—	—	6BD6
110	— 7.5V	110	4.0	36.0	12000	7500	—	2500	1.9	6BF5
250	— 9V	—	—	9.5	8500	1900	16	Power Output, 300 milliwatts		6BF6
Max. DC Plate Volts, 700 Max. DC Cathode mA, 110				Max. Peak Positive-Pulse Plate Volts, 6600 (Abs.) Max. Plate Dissipation, 20 watts						6BG6 6BG6CA
Max. DC Plate Volts, 27000 Max. Unregulated DC Supply Volts, 60000				Max. DC Plate mA, 1.6 Max. Plate Dissipation, 25 Watts						
250	— 5V	250	3.5	35	100000	8500	—	6500	3.5	6BK5
150	56Ω	—	—	18	4600	9300	43	Grid-No. 1 Volts for Cutoff, —11		6BK7A
Max. Peak Inverse Plate Volts, 4500 (Abs.) Max. Peak Plate mA, 1200 Max. DC Plate mA, 200				Max. Peak Heater-Cathode Volts: $\begin{cases} -4500^{**} \text{ (Abs.)} \\ +300 \end{cases}$ <small>**DC component not to exceed —900 volts</small>						6BL4
Max. DC Plate Volts, 500 Max. DC Cathode mA. (Each Unit), 60				Max. Peak Positive-Pulse Plate Volts, 2000 (Abs.) Max. Plate Dissipation (Each Unit), 10 watts						
150	220Ω	—	—	9	6300	6800	43	—	—	6BN4
Max. DC Plate Volts, 550 Max. DC Cathode mA, 110				Max. Peak Positive-Pulse Plate Volts, 5500 (Abs.) Max. Plate Dissipation, 11 watts						6BQ6GT
150	220Ω	—	—	9.0	5800	6000	35	Grid-No. 1 Volts for Cutoff, —10		
125	— 1V	—	—	13.5	7500	—	40	—	—	6BR8
125	— 1V	110	3.5	9.5	200000	5000	—	—	—	
200	330Ω	—	—	11	5900	5600	33	—	—	6BY8



RCA Type	Name	Out-line	Basing Diagram	Heater or Filament (F)		Use Values to right give operating conditions and characteristics for indicated typical use
				Volts	Amperes	
6BW4	Full-Wave Rectifier	0E	00J	6.3	0.9	With Capacitive Input Filter
						With Inductive Input Filter
6BX7GT	Medium-Mu Twin Triode	13D	00D	6.3	1.5	Vertical Deflection Oscillator
						Vertical Deflection Amplifier
6BY5GA	Full-Wave Rectifier	10B	00N	6.3	1.6	Television Damper Service
6BZ8	Medium-Mu Twin Triode	0B	0AJ	6.3	0.4	Each Unit as Class A Amplifier
6C5 6C5GT	Medium-Mu Triode	2A 14A	0Q 0Q	6.3	0.3	Class A Amplifier
6C6	Sharp-Cutoff Pentode	24A	0F	6.3	0.3	Amplifier Detector
6C7	Twin-Diode—Medium-Mu Triode	24B	7G	6.3	0.3	Triode Unit as Class A Amplifier
6C8G	Medium-Mu Twin-Triode	23	0G	6.3	0.3	Each Unit as Class A Amplifier
6CB5	Beam Power Tube	28A	0GD	6.3	2.5	Horizontal Deflection Amplifier
6CD6G	Beam Power Tube	28B	0BT	6.3	2.5	Horizontal Deflection Amplifier
6CG8	Medium-Mu Triode—Sharp-Cutoff Pentode	0B	00F	6.3	0.45	Triode Unit as Class A Amplifier
				6.3	0.45	Pentode Unit as Class A Amplifier
6CH8	Medium-Mu Triode—Sharp-Cutoff Pentode	0B	0FT	6.3	0.45	Triode Unit as Class A Amplifier
				6.3	0.45	Pentode Unit as Class A Amplifier
6CK4	Low-Mu Triode	13F	0JB	6.3	1.25	Vertical Deflection Amplifier
6CL8	Medium-Mu Triode—Sharp-Cutoff Tetrode	0B	0FX	6.3	0.45	Triode Unit as Class A Amplifier
						Tetrode Unit as Class A Amplifier
6CM8	High-Mu Triode—Sharp-Cutoff Pentode	0B	0FZ	6.3	0.45	Triode Unit as Class A Amplifier
						Pentode Unit as Class A Amplifier
6D6	Remote-Cutoff Pentode	24A	0F	6.3	0.3	Amplifier Mixer
6D7	Sharp-Cutoff Pentode	24A	7H	6.3	0.3	Amplifier Detector
6D8G	Pentagrid Converter	23	0A	6.3	0.15	Converter
6DC8	Twin Diode—Remote-Cutoff Pentode	0E	0HE	6.3	0.3	Class A Amplifier
6DM4	Half-Wave Rectifier	13E	4CG	6.3	1.2	Damper Service
6DN6	Beam Power Tube	21B	0BT	6.3	2.5	Horizontal Deflection Amplifier
6DQ4	Half-Wave Rectifier	13F	4CB	6.3	1.2	Damper Service
6DQ6A	Beam Power Tube	2B	0AM	6.3	1.2	Horizontal Deflection Amplifier
6DT6	Sharp-Cutoff Pentode	5C	7EM	6.3	0.3	Class A Amplifier
6DW5	Beam Power Tube	0B	0CK	6.3	1.2	Vertical Deflection Amplifier
6DZ7	Twin Power Pentode	19B	0JP	6.3	1.52	Class A Amplifier
						Both Units as Push-Pull Class AB <sub>1</sub> Amplifier

Plate Volts	Grid Bias or Cathode Resistor	Screen Grid Volts	Screen Grid Cur- rent mA	Plate Cur- rent mA	AC Plate Resist- ance Ohms	Trans- conduct- ance Micromhos	Amplifi- cation Factor	Power		RCA Type
								Load Ohms	Out- put Watts	
Max. AC Volts per Plate (RMS), 325 Max. Peak Inverse Volts, 1275 Total Effect. Supply Imped. per Plate, 82 ohms								Max. DC Output mA, 62.5 Max. Peak Plate mA, per Plate, 350		<b>6BW4</b>
Max. AC Volts per Plate (RMS), 450 Max. Peak Inverse Volts, 1275 Min. Value of Input Choke, 10 henries								Max. DC Output mA, 62.5 Max. Peak Plate mA per Plate, 350		
Max. DC Plate Volts, 500 Max. Plate Dissipation: 10 watts either plate; 12 watts both plates								Max. DC Cathode mA, 180		<b>6BX7GT</b>
Max. DC Plate Volts, 500 Max. DC Cath. mA, 180 Max. Peak Positive-Pulse Plate Volts, 2000 (Abs.) Max. Plate Dissipation: 10 watts either plate; 12 watts both plates										
Max. Peak Inverse Plate Volts, 3000 (Abs.) Max. Peak Plate mA, 525 Max. DC Plate mA, 175								Max. Peak Heater-Cathode Volts: $\begin{cases} -450 \\ +100 \end{cases}$		<b>6BY5GA</b>
125	100Ω	—	—	10	5600	8000	45	—	—	
250	— 8V	—	—	8.0	10000	2000	20	—	—	<b>6C5</b> <b>6C5GT</b>
For other characteristics, refer to Type 6J7										
250	— 9V	—	—	4.5	16000	1250	20	—	—	<b>6C7</b>
250	— 4.5V	—	—	3.2	22500	1600	36	—	—	<b>6C8G</b>
Max. DC Plate Volts, 700 Max. DC Cathode mA, 200								Max. Peak Positive-Pulse Plate Volts, 6800 (Abs.) Max. Plate Dissipation, 23 watts		<b>6C85</b>
Max. DC Plate Volts, 700 Max. DC Cathode mA, 200								Max. Peak Positive-Pulse Plate Volts, 7000 Max. Plate Dissipation, 20 watts		
100	— 1V	—	—	12	6000	6500	40	—	—	<b>6C68</b>
250	— 1V	125	2.2	9	300000	5500	—	—	—	
200	— 6V	—	—	13	5750	3300	19	—	—	<b>6C90</b>
200	180Ω	150	2.8	9.5	300000	6200	—	—	—	
Max. DC Plate Volts, 550 Max. Peak Cathode mA, 350								Max. Peak Positive-Pulse Plate Volts, 2000 (Abs.) Max. Plate Dissipation, 12 watts		<b>6CK4</b>
125	— 1V	—	—	14	5000	8000	40	—	—	
125	— 1V	125	4	12	120000	6000	—	—	—	<b>6CL8</b>
250	— 2V	—	—	1.8	50000	2000	100	—	—	<b>6CM6</b>
250	180Ω	150	2.8	9.5	600000	6200	—	—	—	
For other characteristics, refer to Type 6U7G										
For other characteristics, refer to Type 6J7										
250	— 3V	100	2.7	3.5	360000	Anode-Grid (2): 250 max. volts, 4 mA Oscillator-Grid (1) Resistor. Conversion Transcond., 550 micromhos.		—	—	<b>6D8G</b>
250	— 2V	100	2.7	9	1 M	3800	—	—	—	<b>6DC8</b>
Max. Peak Inverse Plate Volts, 5000 Max. Peak Heater-Cathode Volts, -5000 (DC Component Not to Exceed 900 Volts) Max. Peak Heater-Cathode Volts, +300 (DC Component Not to Exceed 100 Volts)								Max. Peak Plate mA, 1100 Max. DC Plate mA, 175		<b>6DM4</b>
Max. DC Plate Volts, 700 Max. DC Cathode mA, 200								Max. Peak Positive-Pulse Plate Volts, 6600 (Abs.) Max. Plate Dissipation, 15 watts		
Max. Peak Inverse Volts, 5500 Max. Peak Plate mA, 1000								Max. DC Plate mA, 175 Max. Plate Dissipation, 6 watts		<b>6DQ4</b>
Max. DC Plate Volts, 770 Max. DC Cathode mA, 155								Max. Peak Positive-Pulse Plate Volts, 6000 (Abs.) Max. Plate Dissipation, 18 watts		
150	560Ω	100	2.1	1.1	150000	515	—	—	—	<b>6DT6</b>
Max. DC Plate Volts, 330 Max. DC Cathode mA, 65								Max. Peak Positive-Pulse Plate Volts, 2200 Max. Plate Dissipation, 11 watts		<b>6DW5</b>
250	— 7.3V	250	5.5	48	38000	11300	—	—	—	
400	— 11V	250	13	100	—	—	—	9000	18	<b>6DZ7</b>
300	120Ω	250	15	80	—	—	—	9000	12	

RCA Type	Name	Outline	Basing Diagram	Heater or Filament (F)		Use Values to right give operating conditions and characteristics for indicated typical use
				Volts	Amperes	
6E6	Twin Power Amplifier	26	7B	6.3	0.6	Push-Pull Class A Amplifier
6E7	Remote-Cutoff Pentode	24A	7H	6.3	0.3	Amplifier
6EA5	Sharp-Cutoff Tetrode	5C	7EW	6.3	0.2	Class A Amplifier
6EN8	Medium-Mu Triode—Sharp-Cutoff Pentode	6B	9J6	6.3	0.45	Triode Unit as Class A Amplifier Pentode Unit as Class A Amplifier
6EJ7	Sharp-Cutoff Pentode	6C	9AQ	6.3	0.3	Class A Amplifier
6EY7	High-Mu Twin Triode	6E	9LP	6.3	0.6	Relay Control
6EX6	Beam Power Tube	21B	5BT	6.3	2.25	Horizontal Deflection Amplifier
6EY6	Beam Power Tube	13F	7AC	6.3	0.68	Vertical Deflection Amplifier
6EZ5	Beam Power Tube	13F	7AC	6.3	0.8	Vertical Deflection Amplifier
6F5 6F5GT	High-Mu Triode	3 14A	5M 5M	6.3	0.3	Class A Amplifier
6F66 6F6GT	Power Pentode	25 13F	7S 7S	6.3	0.7	Pentode Class A Amplifier Triode □ Class A Amplifier Pentode Push-Pull Class A Amplifier
6F7	Low-Mu Triode—Remote-Cutoff Pentode	24B	7E	6.3	0.3	Triode Unit as Class A Amplifier Pentode Unit as Class A Amplifier
6F86	Medium-Mu Twin Triode	23	86	6.3	0.6	Each Unit as Class A Amplifier
6FE5	Beam Power Tube	13G	8KB	6.3	1.2	Class A Amplifier
6F66	Refer to type 6M84/6F66					
6FQ7	Medium-Mu Twin Triode	6E	9LP	6.3	0.6	Each Unit as Class A Amplifier
6FV8	Medium-Mu Triode—Sharp-Cutoff Pentode	6B	9FA	6.3	0.45	Triode Unit as Class A Amplifier Pentode Unit as Class A Amplifier
6FW8	Medium-Mu Twin Triode	6B	9AJ	6.3	0.4	Each Unit as Class A Amplifier
6G66	Power Pentode	22	7S	6.3	0.15	Pentode Class A Amplifier
6G11	Beam Power Tube—Sharp-Cutoff Pentode	6B	12BU	6.3	1.2	Beam Power Unit as Class A Amplifier Pentode Unit as Class A Amplifier
6GH8	Medium-Mu Triode—Sharp-Cutoff Pentode	6B	9AE	6.3	0.45	Triode Unit as Horiz. Defl. Osc. Pentode Unit as Horiz. Defl. Osc.
6GJ5	Neon Beam Power Tube	18A	90K	6.3	1.2	Horizontal Deflection Amplifier
6GJ8	Medium-Mu Triode—Sharp-Cutoff Pentode	6B	9AE	6.3	0.6	Triode Unit as Class A Amplifier Pentode Unit as Class A Amplifier
6GW6	Beam Power Tube	20	6AM	6.3	1.2	Horizontal Deflection Amplifier
6EY8	Triple High-Mu Triode	6B	9LY	6.3	0.45	Each Unit as Class A Amplifier
6H6 6H6GT	Twin Diode	20B 13B	7Q 7Q	6.3	0.3	Voltage Doubler Half-Wave Rectifier
6J5 6J5GT	Medium-Mu Triode	2A 13B	6Q 6Q	6.3	0.3	Class A Amplifier

□ For two tubes.



Plate Volts	Grid Bias or Cathode Resistor	Screen Grid Volts	Screen Grid Cur- rent mA	Plate Cur- rent mA	AC Plate Resist- ance Ohms	Trans- conduct- ance Micromhos	Amplifi- cation Factor	Power		RCA Type
								Load Ohms	Out- put Watts	
250	-27.5V	—	—	—	—	—	—	14000	1.60†	6E6
For other characteristics, refer to Type 6U7G										
250	-1V	140	0.95	10	150000	8000	—	—	—	6E7
125	-1V	—	—	13.5	—	7500	40	—	—	6EA5
125	-1V	125	4	12	170000	6000	—	—	—	6E8B
200	-2.5V	200	4.1	10	350000	15000	—	—	—	6EJ7
250	0V	—	—	18.5	Grid Volts for Plate $\mu$ A 100 = -9		—	2500-ohm relay		6EV7
150	0V	—	—	10.0	Grid Volts for Plate $\mu$ A 100 = -5			—	—	—
175	-30V	175	3.3	67	8500	7700	—	—	—	6EX6
250	-17.5V	250	3	44	60000	4400	—	—	—	6EY6
250	-20V	250	3.5	43	50000	4100	—	—	—	6EZ5
100	-1V	—	—	0.4	85000	1150	100	—	—	6F5
250	-2V	—	—	0.9	66000	1500	100	—	—	6F5GT
250	-16.5V	250	6.5	34.0	80000	2500	—	7000	3.2	6F6B
285	-20V	285	7.0	38.0	78000	2550	—	7000	4.8	
250	-20V	—	—	31.0	2600	2600	6.8	4000	0.85	6F6GT
315	-24V	285	12.0□	62.0□	—	—	—	10000	11.0†	—
100	-3V	—	—	3.5	16000	500	8	—	—	6F7
250	-3V	100	1.5	6.5	850000	1100	—	—	—	6F8
For other characteristics, refer to Type 6I5										
145	-16V	145	18	100	8000	9500	—	1000	5.6	6FE5
6FG6										
250	-8V	—	—	9	7700	2600	20	—	—	6FQ7
125	-1V	—	—	14	5000	8000	40	—	—	6FV8
125	-1V	125	4	12	200000	6500	—	—	—	6FW8
100	1.2V	—	—	15	2500	13000	33	—	—	6FW9
180	-9V	180	2.5	15.0	175000	2300	—	10000	1.1	6GG6
120	-8V	110	4	49	10000	7500	—	2500	2.3	6G11
150	150 $\Omega$	150	3.5	15	20000	9500	—	—	—	—
Max. DC Plate Volts, 330					Max. Plate Dissipation, 2.5 watts					6GH8
Max. DC Plate Volts, 350			Max. Peak Cathode mA, 300		Max. Plate Dissipation, 2.5 watts			—	—	
Max. Peak Neg.-Pulse Grid Volts, 175					Max. DC Cathode mA, 20		—			—
250	-22.5V	150	2.1	70	15000	7100	—	—	—	6GJ5
125	-1V	—	—	13.5	5000	6500	40	—	—	—
125	-1V	125	4.5	12	150000	7500	—	—	—	6GJ8
250	-22.5V	150	2.1	70	15000	7100	—	—	—	6GW6
125	-1V	—	—	4.5	14000	4500	63	—	—	6GY8
Max. AC Supply Volts per Plate (RMS), 117					Max. DC Output mA, 8 min.					6H6
Min. Total Effect. Plate-Supply Imped. per Plate: half-wave, 30 ohms; full wave, 15 ohms										
Max. AC Plate Volts (RMS), 150					Min. Total Effective Plate-Supply Impedance: up to 117 volts, 15 ohms; at 150 volts, 40 ohms					6HG8T
Max. DC Output mA, 8 per Plate										
90	0V	—	—	10	6700	3000	20	—	—	6J5
250	-8V	—	—	9	7700	2600	20	—	—	6J5GT

† For two tubes at stated plate-to-plate load.

□ For two tubes.

RCA Type	Name	Out-line	Basing Diagram	Heater or Filament (F)		Use Values to right give operating conditions and characteristics for indicated typical use
				Volts	Amperes	
6J6	Medium-Mu Twin Triode	5C	7BF	6.3 6.3	0.45 0.45	Each Unit as Class A Amplifier Push-Pull Class C Amplifier
6J7 6J7G 6J7GT	Sharp-Cutoff Pentode	3 23 14A	7R 7R 7R	6.3	0.3	Pentode Class A RF Amplifier
6J8G	Triode-Heptode Converter	23	8H	6.3	0.3	Triode Unit as Oscillator Heptode Unit as Mixer
6JEB	Beam Power Tube	18B	9QL	6.3	2.5	Horizontal Deflection Amplifier
6JGG	Beam Power Tube	17B	9QU	6.3	1.6	Horizontal Deflection Amplifier
6JS6	Beam Power Tube	16B	12FY	6.3	2.25	Horizontal Deflection Amplifier
6K5GT	High-Mu Triode	14A	5U	6.3	0.3	Class A Amplifier
6K7 6K7G 6K7GT	Remote-Cutoff Pentode	3 23 14A	7R 7R 7R	6.3	0.3	Class A Amplifier
6K8 6K8G 6K8GT	Triode-Hexode Converter	3 23 —	8K 8K 8K	6.3	0.3	Triode Unit as Oscillator Hexode Unit as Mixer
6K11	Twin High-Mu Triode— Medium-Mu Triode	8A	12BY	6.3	0.6	Twin Unit as Class A Amplifier Class A Amplifier
6KLB	Diode—Sharp-Cutoff Pentode	6E	9LQ	6.3	0.3	Pentode Unit as Class A Amplifier
6L5G	Medium-Mu Triode	22	6Q	6.3	0.15	Class A Amplifier
6L6G 6L6GB	Beam Power Tube	27B 19D	7AC 7AC	6.3	0.9	Single-Tube Class A Amplifier Push-Pull Class A Amplifier Push-Pull Class AB <sub>1</sub> Amplifier
6L7 6L7G	Pentagrid Mixer □	3 23	7T 7T	6.3	0.3	Mixer Service
6N6G	Direct-Coupled Power Triode	25	7AU	6.3	0.8	Class A Amplifier
6N7 6N7GT	Medium-Mu Twin Power Triode	2B 13B	8B 8B	6.3	0.8	Class A Amplifier (as Driver) Class B Amplifier
6P5GT	Medium-Mu Triode	13D	6Q	6.3	0.3	Amplifier Detector
6P7G	Low-Mu Triode—Remote-Cutoff Pentode	23	7U	6.3	0.3	Amplifier and Converter
6Q7 6Q7G 6Q7GT	Twin Diode High-Mu Triode	3 23 14A	7V 7V 7V	6.3	0.3	Triode Unit as Class A Amplifier
6Q11	Twin High-Mu Triode— Medium-Mu Triode	8A	12BY	6.3	0.6	Twin Unit as Class A Amplifier Class A Amplifier
6R7 6R7G 6R7GT	Twin Diode—Medium-Mu Triode	3 23 14A	7V 7V 7V	6.3	0.3	Triode Unit as Class A Amplifier
6S4	Medium-Mu Triode	8E	9AC	6.3 6.3	0.6 0.6	Vertical Deflection Amplifier
6S7 6S7G	Remote-Cutoff Pentode	3 23	7R 7R	6.3	0.15	Class A Amplifier

□ For two tubes.

Plate Volts	Grid Bias or Cathode Resistor	Screen Grid Volts	Screen Grid Cur- rent mA	Plate Cur- rent mA	AC Plate Resist- ance Ohms	Trans- conduct- ance Micromhos	Amplifi- cation Factor	Power		RCA Type
								Load Ohms	Out- put Watts	
100	50Ω (For both units)			8.5	7100	5300	38			6J6
150	-10V			30	Grid Current, 16 mA Driving Power, 0.35 watt				3.5	
100	-3V	100	0.5	2.0	1 M	1185				6J7
250	-3V	100	0.5	2.0	1 M	1225				6J7G 6J7GT
100	Triode-Grid Resistor, 50000 ohms			4						6J8G
250				5						
250	-3V	100	2.8	1.4	1.5 M	Conversion Transcond., 290 micromhos				6J8G
For other characteristics, refer to Type 6J6A										6J8G
For other characteristics, refer to Type 6J6A										6J8G
175	-25V	125	4.5	125	5600	11300	Ampl. Factor (Grid No.2 to Plate 3)			6J9G
250	-3V			1.1	50000	1400	70			6K5GT
250	-3V	125	2.6	10.5	600000	1650				6K7 6K7G 6K7GT
100	Grid Res., 50000 ohms			3.8	Triode-Grid & Hexode-Grid Current, 0.15 mA					6K8
100	-3V	100	6.2	2.3	400000	Conversion Transcond., 325 micromhos				6K8G
250	-3V	100	6.0	2.5	600000	Conversion Transcond., 350 micromhos				6K8GT
250	-2V			1.2	62500	1600	100			6K11
250	-8.5V			10.5	7700	2200	17			6K11
100	0	100	2.2	5.5	555000	4300	Grid-No. 1 Volts for plate cur- rent of 10 μA, 4.2			6K18
250	-9V			8.0	9000	1900	17			6L5G
250	-14V	250	5.0	72.0				2500	6.5	6L6G
250	168Ω	250	5.4	75.0				2500	6.5	
270	-17.5V	270	11.0□	134.0□				5000	17.5†	6L6G 6L6GB
270	124Ω□	270	11.0□	134.0□				5000	18.5†	
360	-22.5V	270	5.0□	88.0□				6600	26.5†	6L6G 6L6GB
360	248Ω□	270	5.0□	88.0□				9000	24.5†	
250	-6V	150	9.2	2.3	Oscillator-Grid (No. 3) Bias, -15 volts Grid-No. 3 Peak Swing, 16 volts minimum Conversion Transcond., 350 micromhos					6L7 6L7G
Output Triode: Plate Volts, 300; Plate mA, 45; Load, 7000 ohms Triode: Plate Volts, 300; Grid Volts, 0; Input Plate mA, 8									4.0	6N6G
250	-5V			6.0	11300	3100	35	20000	exceeds	6N7 6N7GT
300	-6V			7.0	11000	3200	35	or more	0.4	
300	0V	Power Output for 1 tube at stated plate-to-plate load						8000	10.0	
250	-13.5			5.0	9500		13.8			6P5GT
For other characteristics, refer to Type 6F7										6P7G
100	-1V			0.8	58000	1200	70			6Q7
250	-3V			1.1	58000	1200	70			6Q7G 6Q7GT
250	-2V			1.2	62500	1600	100			6Q11
150	0V			22	7000	2500	18			6R7
250	-9V			9.5	8500	1900	16			6R7G 6R7GT
Max. DC Plate Volts, 550 Max. DC Cathode mA, 30					Max. Peak Positive-Pulse Plate Volts, 2200 Max. Plate Dissipation, 8.5 watts					6S4
250	-3V	100	2.0	8.5	1 M	1750				6S7 6S7G

† For two tubes at stated plate-to-plate load.

□ for two tubes.



RCA Type	Name	Out-line	Basing Diagram	Heater or Filament (F)		Use Values to right give operating conditions and characteristics for indicated typical use
				Volts	Amperes	
6SB6T	Triode Diode—High-Mu Triode	14C	9CB	6.3	0.3	Triode Unit as Class A Amplifier
6SA7 6SA7GT	Pentagrid Converter	2A 13B	8R 8AB	6.3	0.3	Converter
6SB7Y	Pentagrid Converter	2A	8R	6.3	0.3	Mixer
6SC7	High-Mu Twin Triode	2A	8S	6.3	0.3	Each Unit as Amplifier
6SF5 6SF5GT	High-Mu Triode	2A 13B	8AB 8AB	6.3	0.3	Class A Amplifier
6SF7	Diode—Remote-Cutoff Pentode	2A	7AZ	6.3	0.3	Pentode Unit as Class A Amplifier
6SG7	Semiremote-Cutoff Pentode	2A	8DK	6.3	0.3	Class A Amplifier
6SN7	Sharp-Cutoff Pentode	2A	8DK	6.3	0.3	Class A Amplifier
6SJ7 6SJ7GT	Sharp-Cutoff Pentode	2A 13B	8N 8N	6.3	0.3	Class A Amplifier
6SK7 6SK7GT	Remote-Cutoff Pentode	2A 13B	8N 8N	6.3	0.3	Class A Amplifier
6SN7GT 6SN7 GTA	Medium-Mu Twin Triode	13B 13B	8DB	6.3 6.3 6.3	0.6 0.6 0.6	Each Unit as Class A Amplifier Each Unit as Vertical Amplifier
6SQ7 6SQ7GT	Twin Diode—High-Mu Triode	2A 13B	8Q 8Q	6.3	0.3	Triode Unit as Class A Amplifier
6SR7	Twin Diode—Medium-Mu Triode	2A	8Q	6.3	0.3	Triode Unit as Class A Amplifier
6SS7	Remote-Cutoff Pentode	2A	8N	6.3	0.15	Class A Amplifier
6ST7	Twin Diode—Medium-Mu Triode	2A	8Q	6.3	0.15	Triode Unit as Amplifier
6SZ7	Twin Diode—High-Mu Triode	2A	8Q	6.3	0.15	Triode Unit as Class A Amplifier
6T4	Medium-Mu Triode	5B	7DK	6.3	0.225	Oscillator in UHF TV Receivers Class A Amplifier
6T7G	Twin Diode—High-Mu Triode	22	7V	6.3	0.15	Triode Unit as Class A Amplifier
6T8	Triode Diode—High-Mu Triode	6B	8E	6.3 6.3	0.45 0.45	Triode Unit as Class A Amplifier
6U5	Electron-Ray Tube	13W	8R	6.3	0.3	Visual Indicator
6U7G	Remote-Cutoff Pentode	28J	7R	6.3	0.3	Class A Amplifier
6U8	Medium-Mu Triode—Sharp-Cutoff Pentode	8B	9AE	6.3	0.45	Triode Unit as Class A Amplifier Pentode Unit as Class A Amplifier
6V6GT	Beam Power Tube	13B	7AC	6.3	0.45	Single-Tube Class A Amplifier Push-Pull Class AB <sub>2</sub> Amplifier
6V7G	Twin Diode—Low-Mu Triode	23	7V	6.3	0.3	Triode Unit as Amplifier
6W7G	Sharp-Cutoff Pentode	23	7R	6.3	0.15	Class A Amplifier
6X5	Full-Wave Rectifier	2B	8S	6.3	0.6	With Capacitive-Input Filter With Inductive-Input Filter

Plate Volts	Grid Bias or Cathode Resistor	Screen Grid Volts	Screen Grid Cur- rent mA	Plate Cur- rent mA	AC Plate Resist- ance Ohms	Trans- conduct- ance Micromhos	Amplifi- cation Factor	Power		RCA Type
								Lead Ohms	Out- put Watts	
250	- 2V	—	—	0.9	91000	1100	100	—	—	6S8GT
250	Self- Excited	100	8.5	3.5	1.0	Grid-No. 1 Resistor, 20000 ohms. Conversion Transcond., 450 micromhos		—	—	6SA7 6SA7GT
100	- 1V	100	10.2	3.6	500000	Grid-No. 1 Resistor, 20000 ohms. Conversion Transcond., 950 micromhos		—	—	6SB7Y
250	- 2V	—	—	2.0	53000	1325	70	—	—	6SC7
250	- 2V	—	—	0.9	66000	1500	100	—	—	6SF5 6SF5GT
100	- 1V	100	3.4	12.0	200000	1975	—	—	—	6SF7
250	- 1V	100	3.3	12.4	700000	2050	—	—	—	6SF7
100	- 1V	100	3.2	8.2	250000	4100	—	—	—	6SG7
250	- 2.5V	150	3.4	9.2	1 M	4000	—	—	—	6SG7
100	- 1V	100	2.1	5.3	350000	4000	—	—	—	6SH7
250	- 1V	150	4.1	10.8	900000	4900	—	—	—	6SH7
100	- 3V	100	0.9	2.9	700000	1575	—	—	—	6SJ7
250	- 3V	100	0.8	3.0	1 M	1650	—	—	—	6SJ7GT
100	- 1V	100	4.0	13.0	120000	2350	—	—	—	6SN7
250	- 3V	100	2.6	9.2	800000	2000	—	—	—	6SN7GT
100	0V	—	—	10.0	6700	3000	20	—	—	6SN7GT
250	- 6V	—	—	9.0	7700	2600	20	—	—	6SN7 GTA
Max. DC Plate Volts, 450			Max. Plate Dissipation: 5 watts either plate; 7.5 watts both plates							
Max. Peak Cathode mA, 70			Max. Peak Positive Pulse Plate Volts, 1500							
100	- 1V	—	—	0.5	110000	925	100	—	—	6SQ7
250	- 2V	—	—	1.1	85000	1175	100	—	—	6SQ7GT
250	- 9V	—	—	9.5	8500	1900	16	—	—	6SR7
250	- 3V	100	2.0	9.0	1 M	1850	—	—	—	6SS7
For other characteristics, refer to Type 6SR7										
100	- 1V	—	—	0.8	54000	1300	70	—	—	6ST7
250	- 3V	—	—	1.0	53000	1200	70	—	—	6ST7
Max. DC Plate Volts, 200			Max. Grid mA, 8							
Max. DC Cathode mA, 30			Max. Plate Dissipation, 3.5 watts							
80	150Ω	—	—	18	—	7000	13	—	—	6T4
250	- 3V	—	—	1.2	82000	1050	65	—	—	6T7G
300	4500Ω	—	—	Grid Resistor, ** 0.5 MΩ		Gain per stage, 40		—	—	6T7G
100	- 1V	—	—	0.8	54000	1300	70	—	—	6T8
250	- 3V	—	—	1.0	58000	1200	70	—	—	6T8
Plate & Target Supply, 250 volts. Triode Plate Resistor, 1.0 MΩ Target Current, 4.0 mA Grid Bias, -22 volts; Shadow Angle, 0°. Bias, 0 volts; Angle, 90°; Plate Current, 0.24 mA										
250	- 3V	100	2.0	8.2	800000	1600	—	—	—	6U7G
125	- 1V	—	—	13.5	—	7500	40	—	—	6U8
125	- 1V	110	3.5	9.5	200000	5000	—	—	—	6U8
250	-12.5V	250	4.5	45.0	50000	4100	—	5000	4.5	6V6GT
315	-13V	225	2.2	34.0	80000	3750	—	8500	5.5	
250	-15V	250	5.0□	70.0□	—	—	—	10000	10.0†	6V6GT
285	-19V	285	4.0□	70.0□	—	—	—	8000	14.0†	
For other characteristics, refer to Type 85										
250	- 3V	100	0.5	2.0	1.5 M	1225	—	—	—	6V7G
Max. AC Volts per Plate (RMS), 325			Max. DC Output mA, 70			Min. Total Effect. Supply		Imped. per Plate, 525 ohms		
Max. Peak Inverse Volts, 1250			Max. Peak Plate mA, 245			Min. Value of Input Choke,				
Max. AC Volts per Plate (RMS), 400			Max. DC Output mA, 70			Min. Value of Input Choke,		10 henries		
Max. Peak Inverse Volts, 1250			Max. Peak Plate mA, 245							

† For two tubes at stated plate-to-plate load.

□ For two tubes.

RCA Type	Name	Out- line	Basing Dia- gram	Heater or Filament (F)		Use Values to right give operat- ing conditions and character- istics for indicated typical use
				Volts	Amperes	
6Y5	Full-Wave Rectifier	22 or 13H	6J	6.3	0.8	With Capacitive-Input Filter
6Y7G	High-Mu Twin Power Triode	22	6B	6.3	0.6	Class B Amplifier
6Z4	Refer to type 84/6Z4					
6Z5	Full-Wave Rectifier	22	6K	6.3 12.6	0.8 0.4	With Capacitive-Input Filter
6Z7G	High-Mu Twin Power Triode	22	6B	6.3	0.3	Class B Amplifier
6ZY5G	Full-Wave Rectifier	22	6S	6.3	0.3	With Capacitive-Input Filter
7A4	Medium-Mu Triode	12B	5AC	6.3	0.3	Amplifier
7A5	Beam Power Tube	12C	6AA	6.3	0.75	Class A Amplifier
7A6	Twin Diode	12B	7AJ	6.3	0.15	Detector Rectifier
7A7	Remote-Cutoff Pentode	12B	6V	6.3	0.3	Class A Amplifier
7A8	Octode Converter	12B	6U	6.3	0.15	Converter
7AD7	Power Pentode	12C	6V	6.3	0.6	Class A Amplifier
7AF7	Medium-Mu Twin Triode	12B	8AC	6.3	0.3	Each Unit as Class A Amplifier
7AG7	Sharp-Cutoff Pentode	12B	6V	6.3	0.15	Class A Amplifier
7AH7	Sharp-Cutoff Pentode	12B	6V	6.3	0.15	Class A Amplifier
7B4	High-Mu Triode	12B	5AC	6.3	0.3	Amplifier
7B5	Power Pentode	12C	6AE	6.3	0.4	Class A Amplifier
7B6	Twin Diode—High-Mu Triode	12B	6W	6.3	0.3	Triode Unit as Amplifier
7B7	Remote-Cutoff Pentode	12B	6V	6.3	0.15	Class A Amplifier
7B8	Pentagrid Converter	12B	6X	6.3	0.3	Converter
7C5	Beam Power Tube	12C	6AA	6.3	0.45	Class A Amplifier
7C6	Twin Diode—High-Mu Triode	12B	6W	6.3	0.15	Triode Unit as Class A Amplifier
7C7	Sharp-Cutoff Pentode	12B	6V	6.3	0.15	Class A Amplifier
7E6	Twin Diode—Medium-Mu Triode	12B	6W	6.3	0.3	Triode Unit as Amplifier
7E7	Twin Diode—Remote-Cutoff Pentode	12B	8AE	6.3	0.3	Pentode Unit as Class A Amplifier
7EY6	Beam Power Tube	13F	7AC	7.2	0.6	Vertical Deflection Amplifier
7F7	High-Mu Twin Triode	12B	8AC	6.3	0.3	Each Unit as Amplifier
7F8	Medium-Mu Twin Triode	12A	8BW	6.3	0.3	Each Unit as Class A Amplifier
7G7	Sharp-Cutoff Pentode	12B	6V	6.3	0.45	Class A Amplifier
7H7	Semiremote-Cutoff Pentode	12B	6V	6.3	0.3	Class A Amplifier
7J7	Triode-Heptode Converter	12B	6BL	6.3	0.3	Triode Unit as Oscillator Heptode Unit as Mixer
7K7	Twin Diode—High-Mu Triode	12B	6BF	6.3	0.3	Triode Unit as Class A Amplifier
7L7	Sharp-Cutoff Pentode	12B	6V	6.3	0.3	Class A Amplifier
7N7	Medium-Mu Twin-Triode	12C	8AC	6.3	0.6	Each Unit as Class A Amplifier
7Q7	Pentagrid Converter	12B	8AL	6.3	0.3	Converter
7R7	Twin Diode—Remote-Cutoff Pentode	12B	8AE	6.3	0.3	Pentode Unit as Class A Amplifier
7S7	Triode-Heptode Converter	12B	6BL	6.3	0.3	Triode Unit as Oscillator Heptode Unit as Mixer



Plate Volts	Grid Bias or Cathode Resistor	Screen Grid Volts	Screen Grid Cur- rent mA	Plate Cur- rent mA	AC Plate Resist- ance Ohms	Trans- conduct- ance Micromhos	Amplifi- cation Factor	Power		RCA Type
								Lead Ohms	Out- put Watts	
Max. AC Volts per Plate (RMS), 350 Max. DC Output mA, 50										
For other characteristics, refer to Type 79										
6Y5										
6Y7G										
6Z4										
Max. AC Volts per Plate (RMS), 230 Max. DC Output mA, 60										
6Z5										
180	0V	Power Output is for one tube at stated plate-to-plate load					12000	4.2	6Z7G	
Max. Peak Inverse Volts, 1250				Max. DC Output mA, 40 Max. Peak Plate mA, 120		Min. Total Effect. Supply Imped. per Plate, 225 ohms				
For other characteristics, refer to Type 6J5										
110	— 7.5V	110	3.0	40.0	16000	5800	—	2500	1.5	7A4
125	— 9V	125	3.3	44.0	17000	6000	—	2700	2.2	7A5
Max. AC Voltage per Plate, 150 Volts, RMS						Max. DC Output Current per plate, 8 mA				
For other characteristics, refer to Type 6SN7										
250	— 3V	100	3.2	3.0	700000	Anode-Grid (2): 250 max. volts, 4.2 mA Oscillator-Grid No. 1 Resistor, Con- version Transcond., 550 micromhos		7A8		
300	68Ω	150	7.0	28.0	300000	9500	—	—	—	7AD7
250	— 10V	—	—	9.0	7600	2100	16	—	—	7AF7
250	250Ω	250	2.0	6.0	1 M	4200	—	—	—	7AG7
250	250Ω	250	1.9	6.8	1 M	3300	—	—	—	7AH7
For other characteristics, refer to Type 6BF5										
For other characteristics, refer to Type 6K6GT										
For other characteristics, refer to Type 6SQ7										
250	— 3V	100	1.7	8.5	750000	1750	—	—	—	7B4
For other characteristics, refer to Type 6AB										
For other characteristics, refer to Type 6V6										
250	— 1V	—	—	1.3	100000	1000	100	—	—	7B5
250	— 3V	100	0.5	2.0	2 M	1300	—	—	—	7B6
For other characteristics, refer to Type 6BF6										
250	330Ω	100	1.6	7.5	700000	1300	—	—	—	7B7
For other characteristics, refer to Type 6EY6										
For other characteristics, refer to Type 6SL7GT										
250	500Ω	—	—	6.0	—	3300	48	—	—	7B8
250	— 2V	100	2.0	6.0	800000	4500	—	—	—	7C5
100	— 1.5V	100	2.6	7.5	350000	4000	—	—	—	7C6
250	180Ω	150	3.2	10.0	800000	4000	—	—	—	7C7
250	Triode-Grid Resistor, 50000 ohms		—	5.0	Triode-Grid & Heptode-Grid Current, 0.4 mA					
250	— 3V	100	2.8	1.4	1.5 M	Conversion Transcond., 290 μmhos				
250	— 2V	—	—	2.3	44000	1600	70	—	—	7C8
100	— 1V	100	2.4	5.5	100000	3000	—	—	—	7D6
250	— 1.5V	100	1.5	4.5	1 M	3100	—	—	—	7D7
For other characteristics, refer to Type 6SN7GT										
250	— 2V	100	8.5	3.5	1 M	Grid No. 1 Resistor, 20000 ohms Conversion Transcond., 450 μmhos		7D8		
250	— 1V	100	2.1	5.7	1 M	3200	—	—	—	7E6
100	Triode-Grid Resistor, 50000 ohms		—	3.0	—	—	—	—	—	7E7
250	Triode-Grid Resistor, 50000 ohms		—	5.0	—	—	—	—	—	7E8
250	— 2V	100	3.0	1.8	1.25 M	Conversion Transcond., 525 μmhos				

RCA Type	Name	Out-line	Basing Diagram	Heater or Filament (F)		Use Values to right give operating conditions and characteristics for indicated typical use
				Volts	Amperes	
7V7	Sharp-Cutoff Pentode	12B	8V	6.3	0.45	Class A Amplifier
7W7	Sharp-Cutoff Pentode	12B	8B1	6.3	0.45	Class A Amplifier
7X7	Twin Diode—High-Mu Triode	12C	8BZ	6.3	0.3	Triode Unit as Class A Amplifier
7Y4	Full-Wave Rectifier	12B	5AB	6.3	0.5	With Capacitive-Input Filter
7Z4	Full-Wave Rectifier	12C	5AB	6.3	0.9	With Capacitive-Input Filter
8FQ7	Medium-Mu Twin Triode	8E	9LP	8.4	0.45	Vertical and Horizontal Deflection Oscillators
9BR7	Twin Diode—High-Mu Triode	6B	9CF	4.7 9.4	0.6 0.3	Triode Unit as Class A Amplifier
9CL8	Medium-Mu Triode—Sharp-Cutoff Tetrode	6B	9FX	9.5	0.3	Triode Unit as Class A Amplifier Tetrode Unit as Class A Amplifier
10	Power Triode	27B	4D	7.5F	1.25	Class A Amplifier
10CB	High-Mu Triode—Sharp-Cutoff Pentode	6B	9DA	10.5	0.3	Triode Unit as Class A Amplifier Pentode Unit as Class A Amplifier
11 12	Detector Amplifier	4F 4D	4F 4D	1.1F	0.25	Class A Amplifier
12A5	Power Pentode	22 or 13H	7F	6.3 12.6	0.6 0.3	Class A Amplifier
12A7	Rectifier—Power Pentode	24B	7K	12.6	0.3	Pentode Unit as Class A Amplifier Half-Wave Rectifier
12A8GT	Pentagrid Converter	14A	8A	12.6	0.15	Converter
12AC6	Remote-Cutoff Pentode	5C	7BK	10.0 to 15.9	0.15 approx. at 12.6 V	Class A Amplifier
12AD6	Pentagrid Converter	5C	7CM	10.0 to 15.9	0.15 approx. at 12.6 V	Converter
12AE6	Twin Diode—Medium-Mu Triode	5C	7BT	10.0 to 15.9	0.15 approx. at 12.6 V	Triode Unit as Class A Amplifier
12AEB	Twin Diode—Medium-Mu Triode	5C	7BT	10.0 to 15.9	0.15 approx. at 12.6 V	Triode Unit as Class A Amplifier
12AE7	Dual Triode	6B	9A	10.0 to 15.9	0.45 approx. at 12.6 V	Unit No. 1 as Class A Amplifier Unit No. 2 as Class A Amplifier
12AF6	Remote-Cutoff Pentode	5C	7BK	10.0 to 15.9	0.15 approx. at 12.6 V	Class A Amplifier
12AH7 GT	Medium-Mu Twin Triode	13C	8BE	12.6	0.15	Each Unit as Class A Amplifier
12AJ6	Twin Diode—Medium-Mu Triode	5C	7BT	10.0 to 15.9	0.15 approx. at 12.6 V	Triode Unit as Class A Amplifier
12AL6	Medium-Mu Triode—Power Tetrode	6E	9GS	10.0 to 15.9	0.55 approx. at 12.6 V	Triode Unit as Class A Amplifier Tetrode Unit as Class A Amplifier
12AU7	Medium-Mu Twin Triode	8B	9A	6.3 12.6	0.3 0.15	Each Unit as Class A Amplifier
12AV7	Medium-Mu Twin Triode	6B	9A	6.3 12.6	0.45 0.225	Each Unit as Class A Amplifier

Plate Volts	Grid Bias or Cathode Resistor	Screen Grid Volts	Screen Grid Cur- rent mA	Plate Cur- rent mA	AC Plate Resist- ance Ohms	Trans- conduct- ance Micromhos	Amplifi- cation Factor	Power		RCA Type
								Load Ohms	Out- put Watts	
300	160Ω	150	3.9	10.0	300000	5800	—	—	—	7V7
For other characteristics, refer to Type 7V7										
250	— 1V	—	—	1.9	67000	1500	100	—	—	7X7
Max. Peak Inverse Volts, 1250				Max. DC Output mA, 70			Max. Peak Plate mA, 180			7Y4
Max. Peak Inverse Volts, 1250				Max. DC Output mA, 100 Max. Peak Plate mA, 300			Min. Total Effec. Supply Imped. per Plate, 75 ohms			7Z4
For other characteristics, refer to Type 6FQ7										
250	200Ω	—	—	10	10900	4000	60	—	—	8BR7
125	56Ω	—	—	15	5000	8000	40	—	—	9CL8
125	— 1V	125	4	12	100000	5800	—	—	—	10
425	— 40V	—	—	18.0	5000	1600	8.0	10200	1.6	10
250	390Ω	—	—	7.3	12000	4400	53	—	—	10C8
135	100Ω	135	3.2	11.5	190000	8000	—	—	—	11 12
135	— 10.5V	—	—	3	15500	440	—	—	—	12A5
180	— 25V	180	8.0	45.0	35000	2400	—	3300	3.4	12A7
135	— 13.5V	135	2.5	9.0	100000	975	—	13500	0.55	12A7
Maximum AC Plate Voltage.....							125 Volts, RMS			
Maximum DC Output Current.....							30 Milliamperes			
For other characteristics, refer to Type 6A8GT										
12.6	—	12.6	.2	.55	500000	730	{ Grid-No. 1 Supply Volts, 0 Grid-No. 1 Res., 2.2 megohms }		12AC8	
12.6	Self- excited	12.6	1.5	0.45	1 M	Grid-No. 1 Resistor, 33000 ohms Conversion Transcond., 260 micromhos			12AD6	
12.6	0V	—	—	0.75	15000	1000	15	—	—	12AE6
12.6	0V	—	—	1	13000	1300	16.7	—	—	12AE8A
12.6	Grid Res. 1.5 megohms	—	—	1.9	3150	4000	13.0	—	—	12AE7
12.6	Grid Res. 1 megohm	—	—	7.5	985	6500	6.4	—	—	12AF6
12.6	—	12.6	0.45	1.1	350000	1500	{ Grid-No. 1 Supply Volts, 0 Grid-No. 1 Res., 2.2 megohms }		12AH7 GT	
180	— 6.5V	—	—	7.6	8400	1900	16	—	—	12AJ6
12.6	{ Grid-No. 1 Supply Volts, 0 Grid-No. 1 Res., 2.2 megohms }			0.75	45000	1200	55	—	—	12AL8
12.6	— 0.9V (across 2.2 megohm res.)	—	—	.5	13000	1000	13	—	—	12AU7
Grid-No. 2 (Control Grid) Volts, —.5 (across 2.2 megohm res.)				Grid-No. 1 (Space-Charge Grid) Volts, 12.6			Transcond. (Grid-No. 2 to Plate), 15000 μmhos			Ampl. Factor (Grid-No. 2 to Plate) 7.2 Grid-No. 1 mA, 75 Plate mA, 40 Plate Resistance, 480 ohms
100	0V	—	—	11.8	6250	3100	19.5	—	—	12AV7
250	— 8.5V	—	—	10.5	7700	2200	17	—	—	12AV7
150	56Ω	—	—	18	48000	8500	41	Cutoff Volts, —12		12AV7



RCA Type	Name	Out- line	Biasing Dia- gram	Heater or Filament (F)		Use Values to right give operat- ing conditions and character- istics for indicated typical use
				Volts	Amperes	
12AX4- GT	Half-Wave Rectifier	13D	4CG	12.6	0.6	Television Damper Service
12AX4- GTA		130		12.6	0.6	
12AX7	High-Mu Twin-Triode	6B	9A	6.3 12.6	0.3 0.15	Each Unit as Class A Amplifier
12AZ7	High-Mu Twin-Triode	6B	9A	6.3 12.6	0.45 0.225	Each Unit as Class A Amplifier
12B8GT	High-Mu Triode—Remote-Cutoff Pentode	—	8T	12.6	0.3	Triode Unit as Class A Amplifier Pentode Unit as Class A Amplifier
12BA7	Pentagrid Converter	6E	8CT	12.6	0.15	Converter
12BD6	Remote-Cutoff Pentode	5C	7BK	12.6	0.15	Class A Amplifier
12BF6	Twin Diode—Medium-Mu Triode	5C	7BT	12.6	0.15	Triode Unit as Class A Amplifier
12BH7	Medium-Mu Twin Triode	6E	9A	6.3 12.6	0.6 0.3	Vertical Deflection Amplifier
12BK5	Beam Power Tube	6E	9BQ	12.6	0.6	Class A Amplifier
12BL6	Remote-Cutoff Pentode	5C	7BK	10.0 to 15.9	0.15 approx. at 12.6V	Class A Amplifier
12BR7	Twin Diode—High-Mu Triode	6B	9CF	6.3 12.6	0.45 0.225	Triode Unit as Class A Amplifier
12BV7	Sharp-Cutoff Pentode	6E	9BF	6.3 12.6	0.6 0.3	Class A Amplifier
12BW4	Full-Wave Rectifier	6E	8DJ	6.3	0.9	With Capacitive Input Filter With Inductive Input Filter
12BY7	Sharp-Cutoff Pentode	6E	9BF	6.3 12.6	0.6 0.3	Class A Amplifier
12C8	Twin Diode—Semiremote-Cutoff Pentode	3	8E	12.6	0.15	Pentode Unit as RF Amplifier
12CN5	Remote-Cutoff Pentode	5B	7CV	10.0 to 15.9	0.45 approx. at 12.6V	Class A Amplifier
12CT8	Medium-Mu Triode—Sharp-Cutoff Pentode	6E	9DA	12.6	0.3	Triode Unit as Class A Amplifier Pentode Unit as Class A Amplifier
12CX6	Remote-Cutoff Pentode	5C	7BK	10.0 to 15.9	0.15 approx. at 12.6V	Class A Amplifier
12DE8	Diode—Remote-Cutoff Pentode	6B	9HG	10.0 to 15.9	0.2 approx. at 12.6V	Pentode Unit as Class A Amplifier
12BK7	Twin Diode—Power Tetrode	6E	9HZ	10.0 to 15.9	0.5 approx. at 12.6V	Tetrode Unit as Class A Amplifier
12DL8	Twin Diode—Power Tetrode	6E	9HR	10.0 to 15.9	0.55 approx. at 12.6V	Tetrode Unit as Class A Amplifier
12DM4 12DM4A	Half-Wave Rectifier	13F 13G	4CG	12.6	0.6	Television Damper Service
12DQ6A	Beam Power Tube	2B	8AM	12.6	0.6	Horizontal Deflection Amplifier
12DQ7	Power Pentode	6E	9BF	6.3 12.5	0.6 0.3	Class A Amplifier
12DS7 12DS7A	Twin Diode—Power Tetrode	6E 6E	9JU	10.0 to 15.9	0.4 approx. at 12.6V	Tetrode Unit as Class A Amplifier

Diode Units

Plate Volts	Grid Bias or Cathode Resistor	Screen Grid Volts	Screen Grid Current mA	Plate Current mA	AC Plate Resistance Ohms	Trans-conductance Micromhos	Amplification Factor	Power		RCA Type
								Load Ohms	Output Watts	
Max. Peak Inverse Plate Volts, 4400 Max. Peak Plate mA, 750 Max. DC Plate mA, 125				Max. Peak Heater-Cathode Volts: $\begin{cases} -4400 \\ +300 \end{cases}$ DC component must not exceed 900 volts						12AX4-GT 12AX4-GTA
100 250	-1V -2V	— —	— —	0.5 1.2	80000 62500	1250 1600	100 100	— —	— —	12AX7
100 250	270Ω 200Ω	— —	— —	3.7 10.0	15000 10900	4000 5500	60 60	— —	— —	12AZ7
90	0V	—	—	2.8	37000	2400	90	—	—	
90	-3V	90	2	7	200000	1800	—	—	—	12B8GT
For other characteristics, refer to Type 6BA7										12BA7
For other characteristics, refer to Type 6BD6										12BD6
250	-9V	—	—	9.5	8500	1900	16	Power Output, 300 milliwatts		12BF6
Max. DC Plate Volts, 450 Max. DC Plate mA, 20				Absolute Max. Peak Positive-Pulse Plate Volts, 1500 Max. Plate Dissipation (Each Unit), 3.5 watts						12BH7
250	-5V	250	3.5	35	100000	8500	—	6500	3.5	12BK5
12.6	Grid-No. 1 Supply Volts, 0	12.6	0.5	1.35	500000	1350	Grid-No. 1 and Grid-No. 3 Volts for transcond. of 10 micromhos, -5			12BL8
100 250	270Ω 200Ω	— —	— —	3.7 10	15000 10900	4000 5500	60 60	— —	— —	12BR7
250 250	68Ω -8V	150 180	6 —	27 0.5	85000 —	13000 —	— —	— —	— —	12BV7
For other characteristics, refer to 6BW4										12BW4
250	100Ω	180	5.75	26	93000	11000	—	—	—	12BY7
250	-3V	125	2.3	10	600000	1325	—	—	—	12C8
12.6	—	12.6	3.5	4.5	40000	3800	{ Grid-No. 1 Supply Volts, 0 Grid-No. 1 Res., 2.2 megohms }			12CN5
150	150Ω	—	—	9	8200	4900	40	—	—	12CT8
200	82Ω	125	3.4	15	150000	7000	—	—	—	12CT8
12.6	Grid-No. 1 Supply Volts, 0	12.6	1.4	3	40000	3100	Grid-No. 1 Volts for Plate Current of 10 μA, -4.5			12CX6
12.6	—	12.6	0.5	1.3	300000	1500	Grid No. 1 Supply Volts, 0 Grid-No. 1 Res., 2.2 megohms			12DE8
12.6	—	12.6	1	6	4000	5000	—	3500	0.010	12DK7
12.6	Grid-No. 2 (Control Grid) Volts, -0.5 (across 2.2 megohm resistor) Grid-No. 1 (Space-Charge Grid) Volts, 12.6 Transcond. (Grid-No. 2 to Plate), 15000 μmhos				Ampl. Factor (Grid-No. 2 to Plate) 7.2 Grid-No. 1 mA, 75 Plate Resistance, 480 ohms					12DL8
For other characteristics, refer to Type 6DM4										12DM4 12DM4A
Max. DC Plate Volts, 700 Max. DC Cathode mA, 140				Max. Peak Positive-Pulse Plate Volts, 6000 (Abs.) Max. Plate Dissipation, 15 watts						12DQ6A
200	68Ω	125	5.6	26	53000	10500	—	—	—	12DQ7
12.6	12.6V	-0.5 (across 2.2 megohm resistor)	75 (Grid-No. 1)	35	500	19000 (Grid-No. 2 to Plate)	9.1 (Grid-No. 2 to Plate)	—	—	12DS7 12DS7A
Diode Plate mA, with 10 Volts Applied, 3 mA										

RCA Type	Name	Out-time	Basing Diagram	Heater or Filament (F)		Use Values to right give operating conditions and characteristics for indicated typical use
				Volts	Amperes	
12DU7	Twin Diode—Power Tetrode	6B	9JX	10.0 to 15.9	0.25 approx. at 12.6V	Tetrode Unit as Class A Amplifier
12DV8	Twin Diode—Power Tetrode	6E	9HR	10.0 to 15.9	0.375 approx. at 12.6V	Class A Amplifier
12DW7	Dual Triode	6B	9A	12.6 to 6.3	0.15 to 0.3	Unit No. 1 as Class A Amplifier Unit No. 2 as Class A Amplifier
12BY8	Medium-Mu Triode—Remote-Cutoff Tetrode	6B	9JB	10.0 to 15.9	0.35 approx. at 12.6V	Triode Unit as Class A Amplifier Tetrode Unit as Signal Seeker Relay
12DZ6	Remote-Cutoff Pentode	5C	7BK	10.0 to 15.9	0.19 approx. at 12.6V	Class A Amplifier
12EAS	Remote-Cutoff Pentode	5C	7BK	10.0 to 15.9	0.19 approx. at 12.6V	Class A Amplifier
12EC8	Medium-Mu Triode—Semiremote-Cutoff Pentode	6B	9FA	10.0 to 15.9	0.225 approx. at 12.6V	Triode Unit as Class A Amplifier Pentode Unit as Class A Amplifier
12ED5	Beam Power Tube	5B	7CV	12.6	0.45	Class A Amplifier
12EG6	Pentagrid Amplifier	5C	7CM	10.0 to 15.9	0.15 approx. at 12.6V	Class A Amplifier
12EK6	Remote-Cutoff Pentode	5C	7BK	10.0 to 15.9	0.19 approx. at 12.6V	Class A Amplifier
12EL6	Twin Diode—High-Mu Triode	5C	7FB	10.0 to 15.9	0.15 approx. at 12.6V	Class A Amplifier
12EM6	Diode—Power Tetrode	6E	9HV	10.0 to 15.9	0.5 approx. at 12.6V	Class A Amplifier
12EN6	Beam Power Tube	13B	7AC	12.6	0.6	Vertical Deflection Amplifier
12F5GT	High-Mu Triode	14A	5M	12.6	0.15	Amplifier
12F8	Twin Diode—Remote-Cutoff Pentode	6B	9FH	10.0 to 15.9	0.15 approx. at 12.6V	Pentode Unit as Class A Amplifier
12FK6	Twin Diode—Low-Mu Triode	5C	7BT	10.0 to 15.9	0.15 approx. at 12.6 V	Triode Unit as Class A Amplifier
12FM6	Twin Diode—Medium-Mu Triode	5C	7BT	10.0 to 15.9	0.15 approx. at 12.6V	Triode Unit as Class A Amplifier
12FR8	Diode—Medium-Mu Triode Remote-Cutoff Pentode	6K	9KU	12.6	0.32	Triode Unit as Class A Amplifier
12FV7	Medium-Mu Twin Triode	6E	9A	6.3 to 12.6	0.9 to 0.45	Each Unit as Class A Amplifier
12FX8	Medium-Mu Triode—Pentagrid Converter	6B	9KV	10.0 to 15.9	0.3 approx. at 12.6V	Triode Unit as Class A Amplifier Pentagrid Unit as Converter
12FX8A	Medium-Mu Triode—Pentagrid Converter	6B	9KV	10.0 to 15.9	0.27 approx. at 12.6V	Triode Unit as Class A Amplifier Pentagrid Unit as Converter
12GA6	Pentagrid Converter	5C	7CM	10.0 to 15.9	0.15 approx. at 12.6V	Converter
12GC6	Beam Power Tube	2B	9JX	12.6	0.6	Horizontal Deflection Amplifier
12GJ5	Beam Power Tube	13A	9JK	12.6	0.6	Horizontal Deflection Amplifier



Plate Volts	Grid Bias or Cathode Resistor	Screen Grid Volts	Screen Grid Current mA	Plate Current mA	AC Plate Resistance Ohms	Trans-conductance Micromhos	Amplification Factor	Power		RCA Type
								Load Ohms	Output Watts	
12.6	—	12.6	1.5	12	6000	6200	—	2700	0.025	12DU7
Grid-No. 2 (Control Grid) Resistor, 4.7 megohms Grid-No. 1 (Space-Charge Grid) Volts, 12.6 Transcond. (Grid-No. 2 to Plate), 8500 $\mu$ hos					Ampl. Factor (Grid-No. 2 to Plate) 7.6 Grid-No. 1 mA, 53 Plate Resistance, 900 ohms					12DV8
250	— 2V	—	—	1.2	62500	—	100	—	—	12DW7
250	— 8.5V	—	—	10.5	7700	2200	17	—	—	
12.6	—	—	—	1.2	10000	2000	20	—	—	
10	—	10	—	5 min.	Grid No. 1 resistor 10 megohms.		Plate Load 700 ohms			12BY8
15	— 6V	15	—	3 max.			Plate Load 700 ohms			
12.6	Grid-No.1 Supply Volts, 0	12.6	2.2	4.5	25000	3800	—	—	—	12DZ6
12.6	—	12.6	1.4	3.2	32000	3800	[Grid-No. 1 Supply Volts, 0 Grid-No. 1 Res., 10 megohms]			12EA6
12.6	4700 $\Omega$ (Grid Res.)	—	—	2.4	6000	4700	25	—	—	12EC8
12.6	—	12.6	0.28	0.66	750000	2000	Grid No. 1 Res., 33000 ohms			
1.25	— 4.5V	125	7	37	14000	8500	—	4500	1.5	12EB5
12.6	— 0.6V†	12.6	2.8	.55	150000	800†	†Between Grid No. 3 & Plate †Bias voltage across res. 2.2 megohms			12EG6
12.6	—	12.6	1.7	4	50000	4200	Grid-No. 1 Supply Volts, 0 Grid-No. 1 Res. (Bypassed), 2.2 megohms			12EK
12.6	0V	—	—	0.75	45000	1200	55	—	—	12EL
12.6	—	12.6	1	6	4000	5000	Grid-No. 1 Res., 2.2 megohms			12EM
Max. Peak Pos.-Pulse Volts, 1200 Max. Peak Neg.-Pulse Grid Volts, 250 Max. Peak Cathode mA, 175					Max. Plate Dissipation, 7 watts Max. DC Plate Volts, 300					12EN6
For other characteristics, refer to Type 6F5GT										12F5GT
12.6	0V	12.6	0.38	1	330000	1000	Grid-No. 1 Volts for transcond. of 10 micromhos, —5			12FB
12.6	Grid Supply Volts, 0 Grid Res. (Bypassed), 2.2 megohms	—	—	1.3	6200	1200	7.4	—	—	12FK8
12.6	0V	—	—	1	7700	1300	10	—	—	12FM6
12.6	—0.8V	12.6	0.7	1.9	400000	2700	—	—	—	12FR8
100	— 2V	—	—	16	2250	9600	21.5	—	—	12FV7
12.6	—	—	—	1.3	7150	1400	10	Grid Res., 2.2 megohms		12FX8
12.6	—	12.6	1.25	0.29	500000	Grid No. 3 Res., 2.2 megohms Conversion Transcond., 300 $\mu$ hos				
12.6	— 0.8	—	—	1.3	7150	1400	10			12FX8A
12.6	— 0.5	12.6	1.25	0.29	500000	Grid No. 3 Res., 2.2 megohms Conversion Transcond., 300 $\mu$ hos				
12.6	1.6V	12.6	0.8	0.3	1 M	Grid No. 1 Res., 33000 ohms Conversion. Transcond., 140 $\mu$ hos				12GA6
Max. DC Plate Volts, 770 Max. DC Cathode mA, 175					Max. Peak Positive-Pulse Plate Volts, 6500 Max. Plate Dissipation 17.5 watts					12GC6
For other characteristics, refer to Type 6GJ5										12GJ5

RCA Type	Name	Out- line	Basing Dia- gram	Heater or Filament (F)		Use Values to right give operat- ing conditions and character- istics for indicated typical use
				Volts	Amperes	
12GT5A	Beam Power Tube	17B 31A	9MZ	12.6	0.6	Horizontal Deflection Amplifier
12H6	Twin Diode	29B	7Q	12.6	0.15	Voltage Doubler Half-Wave Rectifier
12J5GT	Medium-Mu Triode	13D	6Q	12.6	0.15	Amplifier
12J7GT	Sharp-Cutoff Pentode	14A	7R	12.6	0.15	Amplifier
12J8	Twin Diode—Power Tetrode	6B	9GC	10.0 to 15.9	0.325 approx. at 12.6V	Tetrode Unit as Class A Amplifier
12K5	Power Tetrode	5D	7EK	10.0 to 15.9	0.4 approx. at 12.6V	Class A Amplifier
12K7GT	Remote-Cutoff Pentode	14A	7R	12.6	0.15	Amplifier
12K8	Triode-Hexode Converter	3	8K	12.6	0.15	Oscillator Mixer
12KL8	Diode—Sharp-Cutoff Pentode	6E	9LQ	12.6	0.15	Pentode Unit as Class A Amplifier
12L6GT	Beam Power Tube	13D	7AC	12.6	0.6	Class A Amplifier
12Q7GT	Twin Diode—High-Mu Triode	14A	7V	12.6	0.15	Triode Unit as Amplifier
12R5	Beam Power Tube	5D	7CV	12.6	0.6	Vertical Deflection Amplifier
12S8GT	Triple Diode—High-Mu Triode	14B	8CB	12.6	0.15	Triode Unit as Class A Amplifier
12SA7 12SA7 GT	Pentagrid Converter	2A 13B	9R 9AB	12.6	0.15	Converter
12SC7	High-Mu Twin Triode	2A	8S	12.6	0.15	Each Unit as Class A Amplifier
12SF5 12SF5 GT	High-Mu Triode	2A 13D	8AB 8AB	12.6	0.15	Class A Amplifier
12SF7	Diode—Remote-Cutoff Pentode	2A	7AZ	12.6	0.15	Pentode Unit as Amplifier
12SG7	Semiremote-Cutoff Pentode	2A	8BK	12.6	0.15	Class A Amplifier
12SH7	Remote-Cutoff Pentode	3	8BK	12.6	0.15	Class A Amplifier
12SJ7 12SJ7 GT	Sharp-Cutoff Pentode	2A 13D	8N 8N	12.6	0.15	Class A Amplifier
12SK7 12SK7 GT	Remote-Cutoff Pentode	2A 13D	8N 8N	12.6	0.15	Class A Amplifier
12SN7 GT	Medium-Mu Twin Triode	13D	8ND	12.6	0.3	Each Unit as Class A Amplifier
12SQ7 12SQ7 GT	Twin Diode—High-Mu Triode	2A 13D	8Q 8Q	12.6	0.15	Triode Unit as Class A Amplifier
12SR7 12SR7 GT	Twin Diode—Medium-Mu Triode	2A 13D	8Q 8Q	12.6	0.15	Triode Unit as Class A Amplifier
12U7	Medium-Mu Twin Triode	6B	7CK	10.0 to 15.9	0.15 approx. at 12.6V	Each Unit as Class A Amplifier
12Z3	Half-Wave Rectifier	22	4G	12.6	0.3	With Capacitive-Input Filter
14A4	Medium-Mu Triode	12B	5AC	12.6	0.15	Class A Amplifier

Plate Volts	Grid Bias or Cathode Resistor	Screen Grid Volts	Screen Grid Cur- rent mA	Plate Cur- rent mA	AC Plate Resist- ance Ohms	Trans- conduct- ance Micromhos	Amplifi- cation Factor	Power		RCA Type
								Load Ohms	Out- put Watts	
Max. DC Plate Volts, 770 Max. DC Cathode mA, 175					Max. Peak Positive-Pulse Plate Volts, 6500 Max. Plate Dissipation, 17.5 watts					12GT5A
Max. AC Supply Volts per Plate (RMS), 117 Min. Total Effect. Plate-Supply Imped. per Plate: half-wave, 30 ohms; full wave, 15 ohms Max. AC Plate Volts (RMS), 150 Max. DC Output mA, 8 per Plate					Max. DC Output mA, 8. min. Min. Total Effective Plate-Supply Impedance: up to 117 volts, 15 ohms; at 150 volts, 40 ohms					12N6
For other characteristics, refer to Type 6J5GT										12J5GT
For other characteristics, refer to Type 6J7GT										12J7GT
12.6	- 0V	12.6	1.5	12	6000	5500	—	2700	0.02	12I8
DC Plate Volts, 12.6 Grid-No. 1 (Space-Charge Grid) Volts, 12.6 DC Plate mA, 40		Grid-No. 2 (Control Grid) Volts, - .5 Grid-No. 1 mA, 75		Plate Resistance, 480 ohms Amplification Factor, Grid-No. 2 to Plate, 7.2 Transcond., Grid-No. 2 to Plate, 15000 $\mu$ mhos						12K5
For other characteristics, refer to Type 6K7GT										12K7GT
For other characteristics, refer to Type 6K8										12K8
For other characteristics, see Type 6KL8										12KL8
110 200	- 7.5V 180 $\Omega$	110 125	4.0 2.2	49 46	13000 28000	8000 8000	—	2000 4000	2.1 3.8	12L6GT
For other characteristics, refer to Type 6Q7GT										12Q7GT
Max. DC Plate Volts, 150 Max. Peak Cathode mA, 155 Max. Plate Dissipation, 4.5 watts					Max. Peak Neg.-Pulse Grid-No. 1 Volts, 150 Max. Grid-No. 2 Volts, 150 Max. Peak Positive-Pulse Plate Volts, 1500 (Abs.)					12R5
250	- 2V	—	—	0.9	91000	1100	100	—	—	12S8GT
For other characteristics, refer to Type 6SA7										12SA7 12SA7 GT
For other characteristics, refer to Type 6SC7										12SC7
For other characteristics, refer to Type 6SF5										12SF5 12SF5 GT
For other characteristics, refer to Type 6SF7										12SF7
For other characteristics, refer to Type 6SG7										12SG7
For other characteristics, refer to Type 6SH7										12SH7
For other characteristics, refer to Type 6SJ7										12SJ7 12SJ7 GT
For other characteristics, refer to Type 6SK7										12SK7 12SK7 GT
For other characteristics, refer to Type 6J5										12SN7 GT
For other characteristics, refer to Type 6SQ7										12SQ7 12SQ7 GT
For other characteristics, refer to Type 6SR7										12SR7 12SR7 GT
12.6	0V	—	—	1	12500	1600	20	—	—	12U7
Max. DC Output mA, 55										12Z3
For other characteristics, refer to Type 6J5										14A4



RCA Type	Name	Out-line	Basing Diagram	Heater or Filament (F)		Use Values to right give operating conditions and characteristics for indicated typical use
				Volts	Amperes	
14A5	Beam Power Tube	12B	6AA	12.6	0.15	Class A Amplifier
14A7	Remote-Cutoff Pentode	12B	8V	12.6	0.15	Class A Amplifier
14AF7	Medium-Mu Twin-Triode	12B	8AC	12.6	0.15	Each Unit as Class A Amplifier
14B6	Twin Diode—High-Mu Triode	12B	8W	12.6	0.15	Triode Unit as Class A Amplifier
14B8	Pentagrid Converter	12B	8X	12.6	0.15	Converter
14C5	Beam Power Tube	12C	6AA	12.6	0.225	Class A Amplifier
14C7	Sharp-Cutoff Pentode	12B	8V	12.6	0.15	Class A Amplifier
14E6	Twin Diode—Medium-Mu Triode	12B	8W	12.6	0.15	Triode Unit as Class A Amplifier
14E7	Twin Diode—Remote-Cutoff Pentode	12B	8AE	12.6	0.15	Pentode Unit as Class A Amplifier
14F7	High-Mu Twin Triode	12B	8AC	12.6	0.15	Each Unit as Class A Amplifier
14F8	Medium-Mu Twin Triode	12A	8BW	12.6	0.15	Each Unit as Class A Amplifier
14H7	Semiremote-Cutoff Pentode	12B	8V	12.6	0.15	Class A Amplifier
14J7	Triode-Heptode Converter	12B	8BL	12.6	0.15	Converter
14N7	Medium-Mu Twin Triode	12C	8AC	12.6	0.3	Each Unit as Class A Amplifier
14Q7	Pentagrid Converter	12B	8AL	12.6	0.15	Converter
14R7	Twin Diode—Remote-Cutoff Pentode	12B	8AE	12.6	0.15	Pentode Unit as Class A Amplifier
15	Sharp-Cutoff Pentode	24B	3F	2.0	0.22	Class A Amplifier
17AX4 GT	Half-Wave Rectifier	13B	4CG	16.8	0.45	Television Damper Service
17BM4	Half-Wave Rectifier	13B	4CG	16.8	0.45	Television Damper Service
17DQ6A	Beam Power Tube	2B	6AM	16.8	0.45	Horizontal Deflection Amplifier
17GJ5	Nevar-Beam Power Tube	18A	8QK	16.8	0.45	Horizontal Deflection Amplifier
17H3	Half-Wave Rectifier	6E	8FK	17.5	0.3	Television Damper Service
17J66	Beam Power Tube	17B	8QU	16.8	0.6	Horizontal Deflection Amplifier
17LD8	Medium-Mu Triode—Sharp-Cutoff Pentode	18F	8QT	16.8	0.45	Triode Unit as Class A Amplifier Pentode Unit as Class A Amplifier
18A5	Beam Power Tube	13F	8CK	18.5	0.3	Horizontal Deflection Amplifier
18FW6	Remote-Cutoff Pentode	5C	7CC 7CC	18.0 18.0	0.1 0.1	Class A Amplifier
18FX6	Pentagrid Converter	5C	7CH 7CM	18.0 18.0	0.1 0.1	Converter
18FY6	Twin Diode—High-Mu Triode	5C	7BT 7BT	18.0 18.0	0.1 0.1	Triode Unit as Class A Amplifier
19	High-Mu Twin Power Triode	22 or 13M	8C	2.0F	0.26	Amplifier
19AB4 GTA	Half-Wave Rectifier	13G	4CE	18.9	0.6	Television Damper Service
19BG66 19BG6 8A	Beam Power Tube	27B	5BT	18.9	0.3	Horizontal Deflection Amplifier
19J6	Medium-Mu Twin Triode	5C	7BF	18.9	0.15	Each Unit as Class A Amplifier
19T8	Triple Diode—High-Mu Triode	—	9E	18.9	0.15	Triode Unit as Class A Amplifier
20	Power Triode	—	4B	3.3F	0.132	Class A Amplifier
20EQ7	Diode—Remote-Cutoff Pentode	6E	9LQ	20.0	0.1	Pentode Unit as Class A Amplifier
21EX6	Beam Power Tube	21B	5BT	21.5	0.6	Horizontal Deflection Amplifier

Plate Volts	Grid Bias or Cathode Resistor	Screen Grid Volts	Screen Grid Current mA	Plate Current mA	AC Plate Resistance Ohms	Trans-conductance Micromhos	Amplification Factor	Power		RCA Type
								Load Ohms	Output Watts	
250	-12.5V	250	5.5	32	70000	3000	—	7500	2.8	14A5
100	-1V	100	4.0	13.0	120000	2350	—	—	—	14A7
250	-3V	100	2.6	9.2	800000	2000	—	—	—	14A7
For other characteristics, refer to Type 7AF7										14AF7
For other characteristics, refer to Type 6SQ7										14B6
For other characteristics, refer to Type 6A8										14B8
315	-13V	225	2.2	34.0	80000	3750	—	8500	5.5	14C5
For other characteristics, refer to Type 6SJ7										14C7
For other characteristics, refer to Type 6BF6										14E6
250	330Ω	100	1.6	7.5	700000	1300	—	—	—	14E7
For other characteristics, refer to Type 6SL7GT										14F7
250	500Ω	—	—	6.0	—	3300	48	—	—	14F8
For other characteristics, refer to Type 7H7										14H7
For other characteristics, refer to Type 7J7										14J7
For other characteristics, refer to Type 6SN7GT										14N7
For other characteristics, refer to Type 6SA7										14Q7
For other characteristics, refer to Type 7R7										14R7
135	-1.5V	67.5	0.3	1.85	800000	750	—	—	—	15
Max. Peak Inverse Plate Volts, 4400 Max. Peak Plate mA, 750 Max. DC Plate mA, 125					Max. Peak Heater-Cathode Volts: { -4000 +300 DC component must not exceed 900 volts					17AX4 GT
For other ratings, refer to Type 60M4										17BM4
Max. DC Plate Volts, 700 Max. DC Cathode mA, 140					Max. Peak Positive-Pulse Plate Volts, 6000 (Abs.) Max. Plate Dissipation, 15 watts					17DQ6A
For other ratings, refer to Type 6GJ5										17EJ5
Max. Peak Inverse Plate Volts, 2000 Max. Peak Plate mA, 450					Max. Average Plate mA, 75 Max. Plate Dissipation, 3 watts					17H3
For other characteristics, refer to Type 17J6A										17J6
150	-5V	—	—	3.3	11300	1900	21.5	—	—	17LD8
120	-8V	110	4	46	11700	7100	—	—	—	17LD8
Max. DC Plate Volts, 350 Max. DC Cathode mA, 90					Max. Peak Pos.-Pulse Plate Volts, 3000 Max. Plate Dissipation, 9 watts					18A5
100	68Ω	100	4.4	11	250000	4400	—	—	—	18FW6
100	-1.5V	100	6.2	2.3	400000	Grid No. 1 Resistor, 20000 ohms Conversion Transcond., 480 μmhos		—	—	18FX6
100	-1V	—	—	0.6	77000	1300	100	—	—	18FY6
For other characteristics, refer to Type 1J6GT										19
For other ratings, refer to Type 6AU4GTA										19AM4 GTA
Max. DC Plate Volts, 700 Max. DC Plate Current, 110 mA.					Max. Peak Positive-Pulse Plate Volts, 6600 (Abs.) Max. Plate Dissipation, 20 watts					19BG6G 19BG6 GA
100	50Ω (For both units at the specified conditions)			8.5	7100	5300	38	—	—	19J6
For other characteristics, refer to Type 6T8A										19TB
135	-22.5V	—	—	6.5	6300	525	3.3	6500	0.110	20
For other characteristics, refer to Type 6EQ7										20EQ7
For other ratings, refer to Type 6EX6										21EX6

RCA Type	Name	Out-line	Basing Diagram	Heater or Filament (F)		Use Values to right give operating conditions and characteristics for indicated typical use
				Volts	Amperes	
22	Sharp-Cutoff Tetrode	29K	4K	3.3F	0.132	Screen-Grid RF Amplifier
22J6B	Beam Power Tube	17B	9QU	22	0.45	Horizontal Deflection Amplifier
24A	Sharp-Cutoff Tetrode	29K	5E	2.5	1.75	Screen-Grid RF Amplifier
25A6 25A6GT	Power Pentode	2B 13D	7S 7S	25.0	0.3	Class A Amplifier
25A7GT	Rectifier—Power Pentode	13D	8F	25.0	0.3	Pentode Unit as Class A Amplifier Half-Wave Rectifier
25AC5 GT	High-Mu Power Triode	13D	8G	25.0	0.3	Amplifier
25B5	Direct-Coupled Power Amplifier		8D	25.0	0.3	Amplifier
25B6G	Power Pentode	25	7S	25.0	0.3	Class A Amplifier
25B8GT	High-Mu Triode—Remote-Cutoff Pentode	13D	8T	25.0	0.15	Triode Unit as Class A Amplifier Pentode Unit as Class A Amplifier
25BK5	Beam Power Tube	8E	9BQ	25	0.3	Class A Amplifier
25BQ6 GT	Beam Power Tube	14D	6AM	25.0	0.3	Horizontal Deflection Amplifier
25C6G	Beam Power Tube	25	7AC	25.0	0.3	Class A Amplifier
25CD6 GA	Beam Power Tube	21B	5BT 5BT	25 25	0.6	Horizontal Deflection Amplifier
25EC6	Beam Power Tube	21A	5BT	25.0	0.6	Horizontal Deflection Amplifier
25L6	Beam Power Tube	2B	7AC	25.0	0.3	Amplifier
25LBGT	Beam Power Tube	13D	7AC	25.0	0.3	Amplifier
25N6G	Direct-Coupled Power Amplifier	—	7W	25.0	0.3	Class A Amplifier
25W4GT	Half-Wave Rectifier	13D	4CG	25.0	0.3	Television Damper Service
25Y5	Rectifier-Doubler	22 or 13H	8E	25.0	0.3	Half-Wave Rectifier
25Z5	Rectifier-Doubler	22 or 13H	8E	25.0	0.3	Rectifier-Doubler
25Z6 25Z6GT	Rectifier-Doubler	2B 13D	7G 7G	25.0 25.0	0.3 0.3	Voltage Doubler Half-Wave Rectifier
26	Medium-Mu Triode	26	4B	1.5F	1.05	Class A Amplifier
27	Low-Mu Triode	22 or 13H	5A	2.5	1.75	Class A Amplifier
30	Medium-Mu Triode	22 or 13H	4D	2.0F	0.06	Amplifier
31	Power Triode	22 or 13H	4B	2.0F	0.13	Class A Amplifier
32	Sharp-Cutoff Tetrode	29K	4K	2.0F	0.06	Class A Amplifier
32ET5	Power Pentode	5B	7CV	32.0	0.1	Class A Amplifier
32L7GT	Rectifier—Beam Power Tube	14A	8Z	32.5	0.3	Class A Amplifier Half-Wave Rectifier
33	Power Pentode	25	5K	2.5F	0.26	Class A Amplifier
34	Remote-Cutoff Pentode	29K	4M	2.0F	0.06	Screen-Grid RF Amplifier



Plate Volts	Grid Bias or Cathode Resistor	Screen Grid Volts	Screen Grid Current mA	Plate Current mA	AC Plate Resistance Ohms	Trans-conductance Micromhos	Amplification Factor	Power		RCA Type
								Load Ohms	Output Watts	
135	- 1.5V	67.5	1.3 (Max.)	3.7	325000	500	—	—	—	22
For other characteristics, refer to Type 22J6A										
250	- 3V	90	1.7 (Max.)	4.0	600000	1050	—	—	—	24A
95	-15V	95	4	20	45000	2000	—	4500	0.9	25A6 25A6GT
100	-15V	100	4.0	20.5	50000	1800	—	4500	0.77	25A7 GT
Max. AC Plate Volts (RMS), 117				Max. DC Output mA, 75			Max. Peak Plate mA, 450			
110	+15V (Grid mA, 7)			15	15200	3800	58	—	—	25AC5 GT
For other characteristics, refer to Type 25N6G										
200	-23V	135	1.8	62.0	18000	5000	—	2500	7.1	25B6G
100	- 1V	—	—	0.6	75000	1500	112	—	—	25B8GT
100	- 3V	100	2.0	7.6	185000	2000	—	—	—	25BK5
For other characteristics, refer to Type 6BK5										
Max. DC Plate Volts, 600				Absolute Max. Peak Positive-Pulse Plate Volts, 6000 (Abs.)						25BQ6
Max. DC Cathode mA, 112.5				Max. Plate Dissipation, 11 Watts						GT
For other characteristics, refer to Type 6Y6G										
Max. DC Plate Volts, 700				Max. Peak Positive-Pulse Plate Volts, 7000						25C06
Max. DC Plate mA, 200				Max. Plate Dissipation, 20 Watts						GA
Max. DC Plate Volts, 700				Max. Peak Positive-Pulse Plate Volts, 700 (Abs.)						25EC6
Max. DC Cathode mA, 200				Max. Plate Dissipation 10 watts.						
110	- 7.5V	110	4	49	13000	9000	—	2000	2.1	25L6
200	- 8V	110	2	50	30000	9500	—	3000	4.3	25L6GT
For other characteristics, refer to Type 50L6GT										
Output Triode: Plate Volts, 180; Plate mA, 45; Load, 4000 ohms									3.8	25N6G
Triode: Plate Volts, 100; Grid Volts, 0; A-F Signal Volts (Peak), 29.7; Plate mA, 5.8										
Max. Peak Inverse Plate Volts, 3850 (Abs.)				Max. Peak Heater-Cathode Volts: { -500 (Abs.)						25W4GT
Max. Peak Plate mA, 750				+200						
Max. DC Plate mA, 125				DC Component must not exceed 100 volts						
Max. DC Output mA per Plate, 75										
For other ratings, refer to Type 25Z6										
Max. AC Volts per Plate (RMS), 117				Min. Total Effective Plate-Supply Impedance: Half-Wave, 30 ohms; Full-Wave, 15 ohms						25Z6
Max. DC Output mA, 75										
Max. AC Volts per Plate (RMS), 235				Min. Total Effect. Supply Imped. per Plate: at 117 volts						25Z6GT
Max. DC Output mA per Plate, 75				15 ohms; at 150 volts, 40 ohms; at 235 volts, 100 ohms						
180	-14.5V	—	—	6.2	7300	1150	8.3	—	—	26
250	-21V	—	—	5.2	9250	975	9.0	—	—	27
For other characteristics, refer to Type 1H4G										
180	-30V	—	—	12.3	3600	1050	3.8	5700	0.375	30
180 (Max.)	- 3V	67.5	0.4	1.7	1 M	650	—	—	—	32
110	- 7.5V	110	2.8	30	21500	5500	—	2800	1.2	32E75
90	- 7V	90	2.0	27.0	17000	4800	—	2600	1.0	32L7GT
Maximum AC Plate Voltage.....								125 Volts, RMS		
Maximum DC Output Current.....								60 Milliamperes		
180	-18V	180	5.0	22.0	55000	1750	—	6000	1.4	33
180	- 3V min.	67.5	1.0	2.8	1 M	620	—	—	—	34

RCA Type	Name	Out- line	Basing Dia- gram	Heater or Filament (F)		Use Values to right give operat- ing conditions and character- istics for indicated typical use
				Volts	Amperes	
34GD5	Beam Power Tube	5B	7CV 7CV	34.0 34.0	0.1 0.1	Class A Amplifier
35	Remote-Cutoff Tetrode	29K	5E	2.5	1.75	Screen-Grid RF Amplifier
35A5	Beam Power Tube	12C	6AA	35.0	0.15	Single-Tube Class A Amplifier
35B5	Beam Power Tube	5B	7BZ	35.0	0.15	Class A Amplifier
35DZ8	High-Mu Triode—Power Pentode	6N	9JE	35.0	0.15	Triode Unit as Class A Amplifier Pentode Unit as Class A Amplifier
35GL6	Beam Power Tube	5B	7FZ	35.0	0.15	Class A Amplifier
35Y4	Half-Wave Rectifier Heater Tap for Pilot	12C	5AL Pilot Between Pins 1 and 4	35.0	0.15	With Capacitive-Input Filter
35Z3	Half-Wave Rectifier	12C	4Z	35.0	0.15	With Capacitive-Input Filter
35Z4GT	Half-Wave Rectifier	13D	5AA	35.0	0.15	With Capacitive-Input Filter
36	Sharp-Cutoff Tetrode	24B	5E	6.3	0.3	Screen-Grid RF Amplifier
36AM3	Half-Wave Rectifier	5B	5BQ	36.0	0.1	With Capacitive-Input Filter
36AM3A	Half-Wave Rectifier	5B	5BQ 5BQ	36.0 36.0	0.1 0.1	With Capacitive-Input Filter
37	Medium-Mu Triode	22 or 13H	5A	6.3	0.3	Class A Amplifier
38	Power Pentode	24B	5F	6.3	0.3	Class A Amplifier
39/44	Remote-Cutoff Pentode	24B	5F	6.3	0.3	Class A Amplifier
40	Medium-Mu Triode	2B	4B	5.0F	0.25	Class A Amplifier
41	Power Pentode	22 or 13H	6B	6.3	0.4	Amplifier
42	Power Pentode	2B	6B	6.3	0.7	Amplifier
43	Power Pentode	2B	6B	25.0	0.3	Amplifier
45	Power Triode	2B	4D	2.5F	1.5	Class A Amplifier
45Z3	Half-Wave Rectifier	5C	5AM	45.0	0.075	Half-Wave Rectifier
45Z5GT	Half-Wave Rectifier Heater Tap for Pilot	13D	6AB Pilot Between Pins 2 and 3	45.0	0.15	With Capacitive-Input Filter
46	Dual-Grid Power Amplifier	27B	5C	2.5F	1.75	Class A Amplifier
47	Power Pentode	27B	5B	2.5F	1.75	Class A Amplifier
48	Power Tetrode	27B	6A	30.0	0.4	Class A Amplifier
49	Dual-Grid Power Amplifier	2B	5C	2.0F	0.12	Class A Amplifier
50	Power Triode	29L	4B	7.5F	1.25	Class A Amplifier
50A5	Beam Power Tube	12C	6AA	50.0	0.15	Class A Amplifier
50C6G	Beam Power Tube	25	7AC	50.0	0.15	Single-Tube Class A Amplifier
50FE5	Beam Power Tube	13B	8KB	50.0	0.15	Class A Amplifier
50FK5	Power Pentode	5B	7CV	50.0	0.1	Class A Amplifier
50XB	Rectifier-Doubler	12C	7DX	50.0	0.15	Rectifier-Doubler
50Y6GT	Rectifier-Doubler	13D	7B	50.0	0.15	Rectifier-Doubler
50Y7GT	Rectifier-Doubler Heater Tap for Pilot	13D	6AM Pilot Between Pins 6 and 7	50.0	0.15	Voltage Doubler Half-Wave Rectifier
50Z7G	Rectifier-Doubler Heater Tap for Pilot	22	6AM Pilot Between Pins 6 and 7	50.0	0.15	Voltage Doubler Half-Wave Rectifier
53	High-Mu Twin Power Triode	2B	7B	2.5	2.0	Amplifier

Plate Volts	Grid Bias or Cathode Resistor	Screen Grid Volts	Screen Grid Current mA	Plate Current mA	AC Plate Resistance Ohms	Trans-conductance Micromhos	Amplification Factor	Power		RCA Type
								Load Ohms	Output Watts	
110	- 7.5V	110	3	35	13000	5700	—	2500	1.4	34GD5
250	- 3V min.	90	2.5*	6.5	—	1050	—	—	—	35
For other characteristics, refer to Type 35L6GT										35A5
For other characteristics, refer to Type 35C5										35B5
120	1500Ω	—	—	0.8	—	1400	100	—	—	350Z8
140	180Ω	120	6	45	—	7500	—	2500	2.0	
110	- 7.5V	110	3	45	12000	7500	—	2500	1.8	35GL6
For other characteristics, refer to Type 35W4										35Y4
For other ratings, refer to Type 35Z5GT										35Z3
Max. DC Output mA, 100					Min. Total Effective Plate-Supply Impedance: Up to 117 volts, 15 ohms; at 235 volts, 100 ohms					35Z4GT
100	- 1.5V	55	—	1.8	550000	850	—	—	—	36
250	- 3V	90	1.7	3.2	550000	1080	—	—	—	
AC Plate Volts (RMS), 117 Max. DC Output mA, 82					Max. Peak Inverse Volts, 365 Tube Voltage Drop for Plate mA, 150, 20 volts					36AM3
Max. AC Plate Volts (RMS), 120 Max. DC Output mA, 82					Max. Peak Inverse Volts, 365 Tube Voltage Drop for Plate mA, 150, 16 volts					36AM3A
250	- 18V	—	—	7.5	8400	1100	9.2	—	—	37
250	- 25V	250	3.8	22.0	100000	1200	—	10000	2.50	38
250	- 3V min.	90	1.4	5.8	1.0	1050	—	—	—	39/44
180	- 3V	—	—	0.2	150000	200	30	—	—	40
For other characteristics, refer to Type 6K6GT										41
For other characteristics, refer to Type 6F6G										42
For other characteristics, refer to Type 25A6										43
275	- 58V	—	—	36.0	1700	2050	3.5	4500	2.00	45
Max. Peak Inverse Volts, 350			Max. DC Output mA, 65			Max. Peak Plate mA, 390				45Z3
For other ratings, refer to Type 35Z5GT										45Z5GT
250	- 33V	—	—	22	2380	2350	5.6	6400	1.25	46
250	450Ω	250	6.0	31	60000	2500	—	7000	2.7	47
125	- 20V	100	9.5	56	—	3900	—	1500	2.5	48
135	- 20V	—	—	6.0	4175	1125	4.7	11000	0.17	49
450	- 84V	—	—	55	1800	2100	3.8	4350	4.6	50
For other characteristics, refer to Type 50L6GT										50A5
135	- 13.5V	135	3.5	58	9300	7000	—	2000	3.6	50C6G
200	- 14V	135	2.2	61	18300	7100	—	2600	6	
For other characteristics, refer to Type 6FE5										50FE5
110	62Ω	115	8.5	32	14000	12800	—	3000	1.2	50FK5
For other ratings, refer to Type 25Z6GT										50XB
For other ratings, refer to Type 25Z6GT										50Y6GT
Max. AC Volts per Plate (RMS), 117 Max. DC Output mA, 65					Min. Total Effective Plate-Supply Impedance per Plate, 15 ohms					50Y7GT
Max. AC Volts per Plate (RMS), 235 Max. DC Output mA per Plate, 65					Min. Total Effec. Plate-Supply Imped. per Plate: At 117 volts, 15 ohms; at 150 volts, 40 ohms; at 235 volts, 100 ohms					50Z7G
Max. DC Output mA, 65										50Z7G
Max. DC Output mA per Plate, 65										50Z7G
For other characteristics, refer to Type 6N7										53



RCA Type	Name	Out- line	Biasing Dia- gram	Heater or Filament (F)		Use Values to right give operat- ing conditions and character- istics for indicated typical use
				Volts	Amperes	
70L7GT	Rectifier-Beam Power Tube	13F	8AA	70.0	0.15	Amplifier Unit as Class A Amplifier Half-Wave Rectifier
75	Twin Diode—High-Mu Triode	24B	6G	6.3	0.3	Amplifier
78	Remote-Cutoff Pentode	24B	6F	6.3	0.3	Amplifier Mixer
80	Full-Wave Rectifier	28	4C	5.0F	2.0	With Capacitive-Input Filter With Inductive-Input Filter
84/6Z4	Full-Wave Rectifier	22 or 13H	5D	6.3	0.5	With Capacitive-Input Filter With Inductive-Input Filter
117L7 GT/ M7GT	Rectifier-Beam Power Tube	13F	8AG	117	0.09	Amplifier Unit as Class A Amplifier Half-Wave Rectifier
117N7 GT	Rectifier-Beam Power Tube	13F	8AV	117	0.09	Amplifier Unit as Class A Amplifier Half-Wave Rectifier
117P7 GT	Rectifier-Beam Power Tube	13F	8AV	117	0.09	
117Z3	Half-Wave Rectifier	5D	4CB	117	0.04	With Capacitive-Input Filter
117Z4 GT	Half-Wave Rectifier	28F	5AA	117	0.04	With Capacitive-Input Filter
117Z6 GT	Rectifier-Doubler	13D	7R	117	0.075	Voltage Doubler Half-Wave Rectifier
7027	Beam Power Tube	19F	8NY	6.3	0.9	Push-Pull Class AB <sub>1</sub> Amplifier
7247	Dual Triode	6B	9A	12.6 6.3	0.15 0.3	Push-Pull Class AB <sub>1</sub> Amplifier Unit No. 1 as Class A Amplifier Unit No. 2 as Class A Amplifier
7591	Beam Power Tube	13D	8KQ	6.3	0.8	Class A Amplifier Push-Pull Class AB <sub>1</sub> Amplifier
7685	Beam Power Tube	13D	9PX	50	0.15	Class A Amplifier Push-Pull Class AB <sub>1</sub> Amplifier
EM84/ 6FC6	Electron-Ray Tube	6F	9GA	6.3	0.27	Visual Indicator

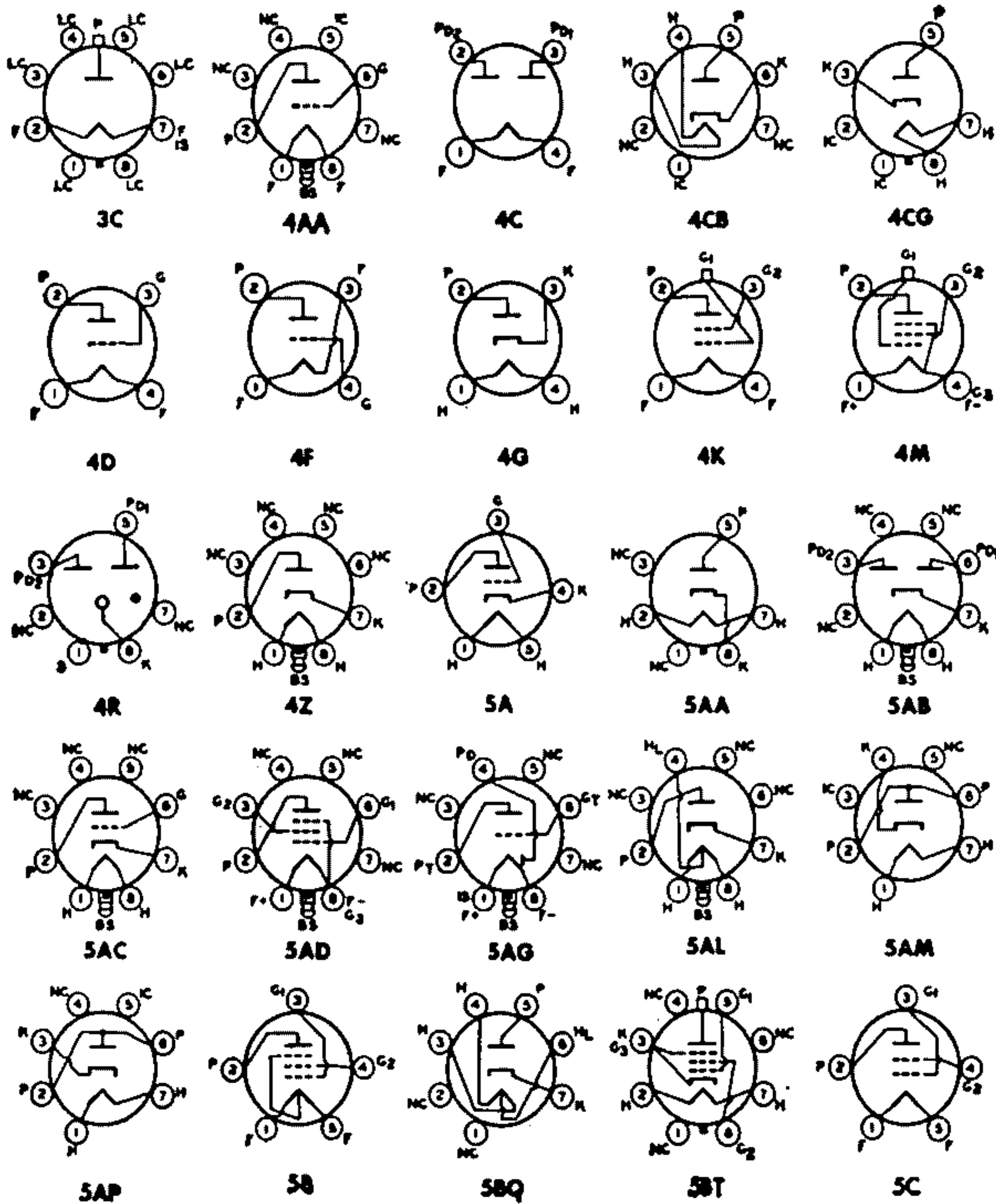
Plate Volts	Grid Bias or Cathode Resistor	Screen Grid Volts	Screen Grid Cur- rent mA	Plate Cur- rent mA	AC Plate Resist- ance Ohms	Trans- conduct- ance Micromhos	Amplifi- cation Factor	Power		RCA Type
								Load Ohms	Out- put Watts	
110	- 7.5V	110	3.0	40.0	15000	7500	—	2000	1.8	70L7GT
Max. Peak Inverse Volts, 350		Max. DC Output mA, 70		Max. Peak Plate mA, 420						
		Min. Total Effect. Plate-Supply Imped., 15 ohms								
For other characteristics, refer to Type 6SQ7										75
For other characteristics, refer to Type 6K7										78
AC Volts per Plate (RMS), 350		DC Output mA, 125		Min. Total Effect. Supply Imped. per Plate, 50 ohms						80
Max. Peak Inverse Volts, 1400		Max. Peak Plate mA, 440		Min. Value of Input Choke, 10 henries						
AC Volts per Plate (RMS), 500		Max. DC Output mA, 125		Min. Value of Input Choke, 10 henries						84/824
Max. Peak Inverse Volts, 1400		Max. Peak Plate mA, 440		Total Effect. Supply Imped. per Plate, 150 ohms						
AC Volts per Plate (RMS), 325		DC Output mA, 60		Value of Input Choke, 10 henries						117L7 GT/ M7GT
Max. Peak Inverse Volts, 1250		Max. Peak Plate mA, 180								
AC Volts per Plate (RMS), 450		Max. DC Output mA, 60								117N7 GT
Max. Peak Inverse Volts, 1250		Max. Peak Plate mA, 180								
105	- 5.2V	105	4	43	17000	5300	—	4000	0.85	117L7 GT/ M7GT
Max. AC Plate Volts (RMS), 117		Max. DC Output mA, 75		Min. Total Effect. Plate-Supply Imped., 15 ohms						
Max. Peak Inverse Volts, 350		Max. Peak Plate mA, 450								
100	- 6V	100	5	51	16000	7000	—	3000	1.2	117N7 GT
Max. AC Plate Volts (RMS), 117		Max. DC Output mA, 75		Min. Total Effect. Plate-Supply Impedance, 15 ohms						
Max. Peak Inverse Volts, 350		Max. Peak Plate mA, 450								
For other characteristics, refer to Type 117L7/M7GT										117P7 GT
Max. Peak Inverse Volts, 330		Max. DC Output mA, 90		Min. Total Effect. Plate-Supply Imped., 20 ohms						117Z3
Max. Peak Inverse Volts, 350		Max. Peak Plate mA, 540		Min. Total Effect. Plate-Supply Imped., 30 ohms						117Z4 GT
AC Volts per Plate (RMS), 117		DC Output mA, 60		Min. Total Effective Plate-Supply Impedance per Plate: Half-Wave, 30 ohms; Full-Wave, 15 ohms						117Z8 GT
DC Output mA, 60		Min. Total Effect. Supply Imped. per Plate: At 117 volts, 15 ohms; at 150 volts, 40 ohms; at 235 volts, 100 ohms								
AC Volts per Plate (RMS), 235		DC Output mA per Plate, 60								
450	-30V	350	3.4□	95□	—	—	—	6000	50	7027
400	200Ω	300	7□	112□	—	—	—	6600	32	
380	180Ω	380	5.6□	138□	—	—	—	4500	36	
410	220Ω	—	Cath. mA, 134	—	—	—	—	8000	24	
250	- 2V	—	—	1.2	62500	1600	100	—	—	7247
250	- 8.5V	—	—	10.5	7700	2200	17	—	—	
300	-10V	300	8	60	29000	10200	—	3000	11	7591
450	200Ω	400	11.5	82	—	—	—	9000	28†	
130	-11V	130	5	100	7000	11000	—	1100	4.5	7895
140	50Ω	140	9	210	—	—	—	1500	10†	
Triode Plate Supply Volts, 250		Triode-Plate Resistance, 1 MΩ		Triode Plate mA, 0.06		Fluorescent-Target Volts, 250		Triode-Grid Resistance, 0.47 MΩ		EM84/ 8FC8
Triode Grid-Supply Volts, -22		Max. Length of Dark Part of Target, when triode grid resistor = 0, 1.14 inch				Fluorescent Target mA, 1.6				

† For two tubes at stated plate-to-plate load.

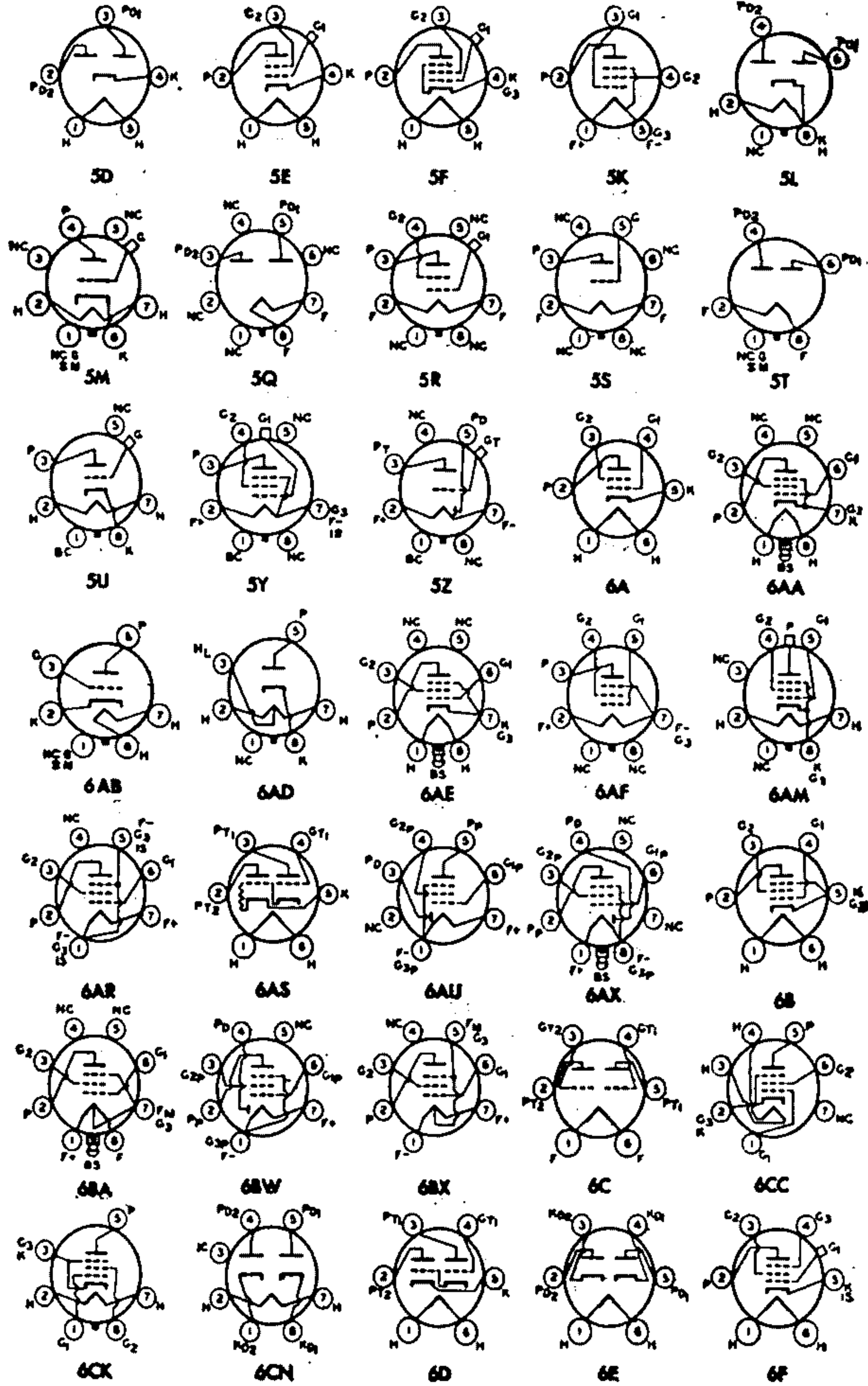
□ For two tubes.

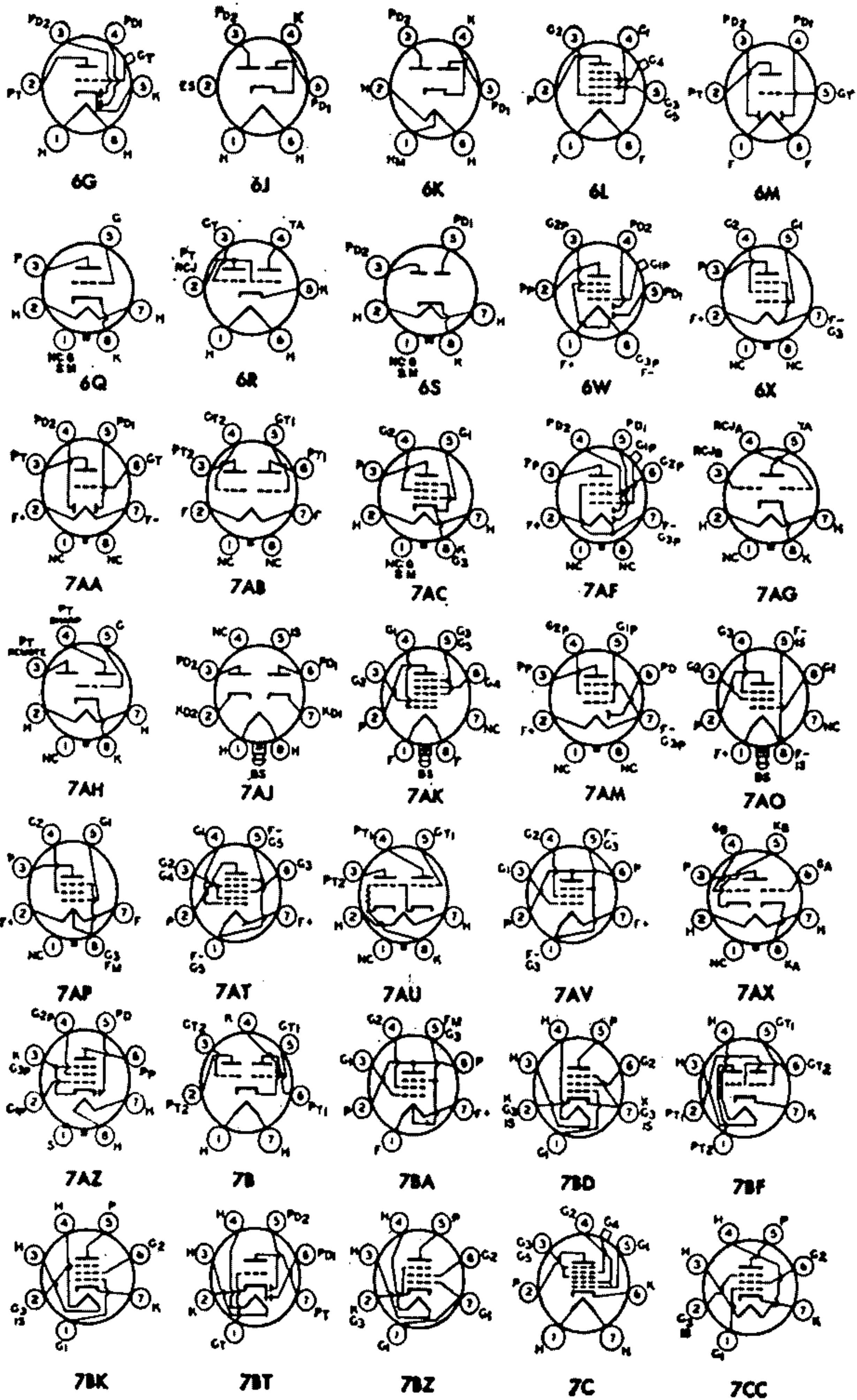
# Basing Diagrams for RCA Replacement and Discontinued Types

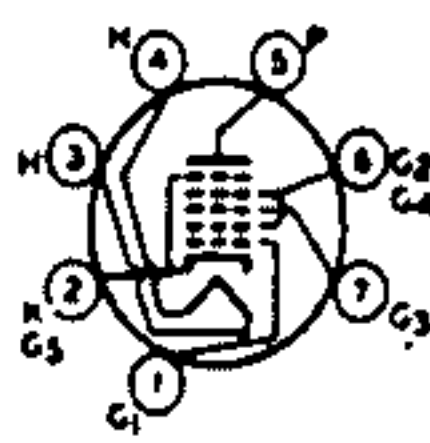
For Key: Basing Diagrams, see inside back cover.



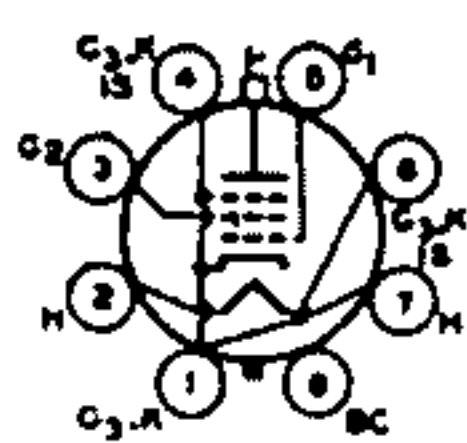








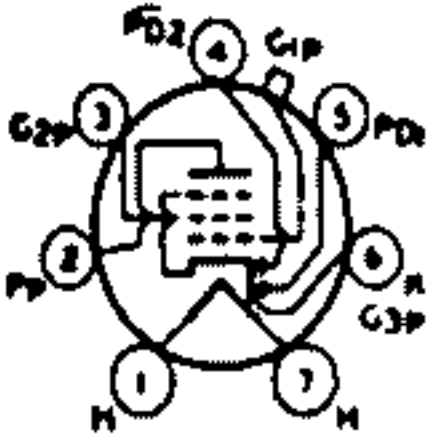
7CH



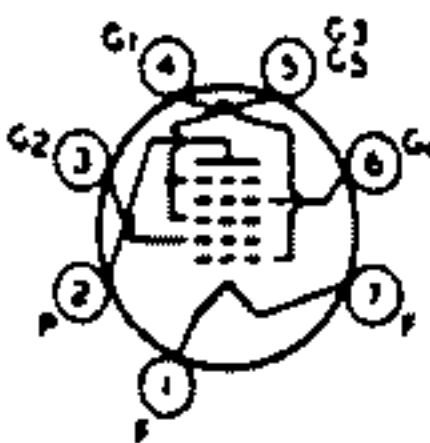
7CK



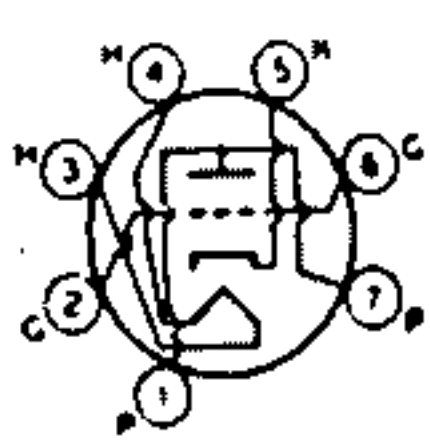
7CV



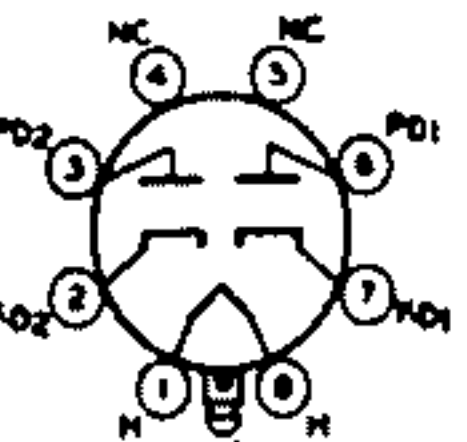
7D



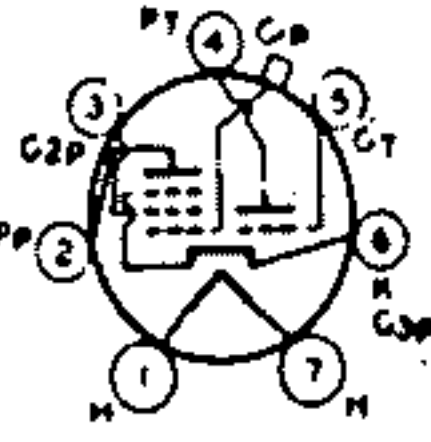
7DC



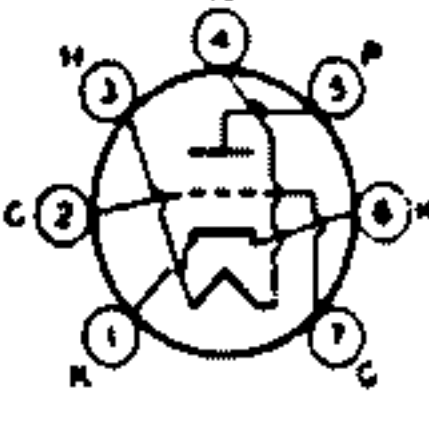
7DK



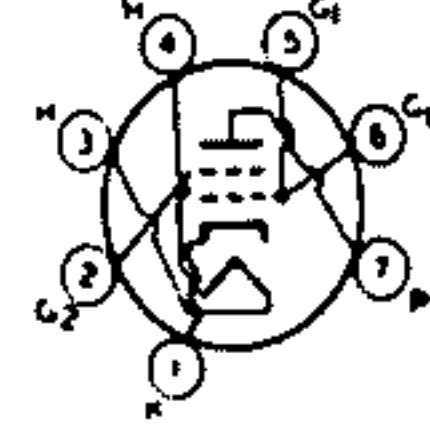
7DX



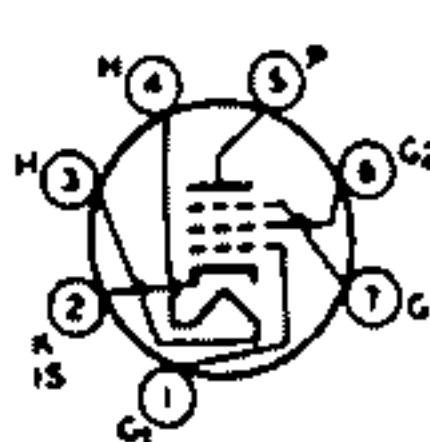
7E



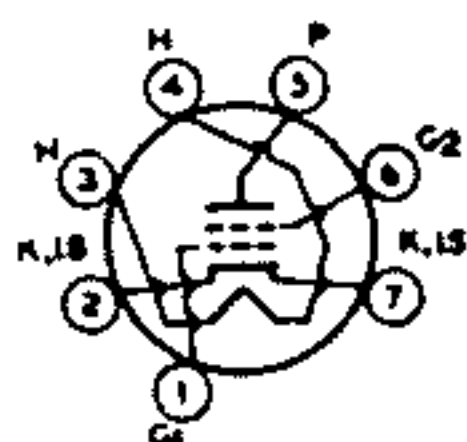
7EG



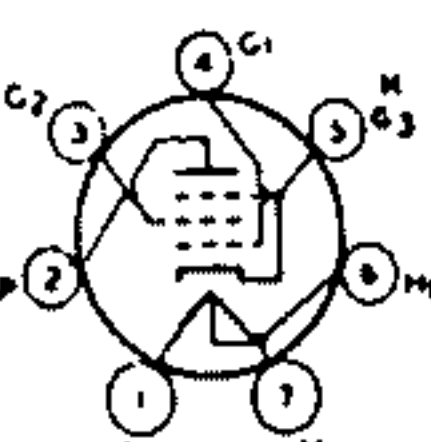
7EK



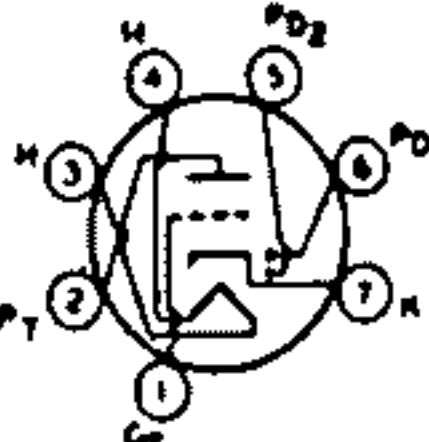
7EN



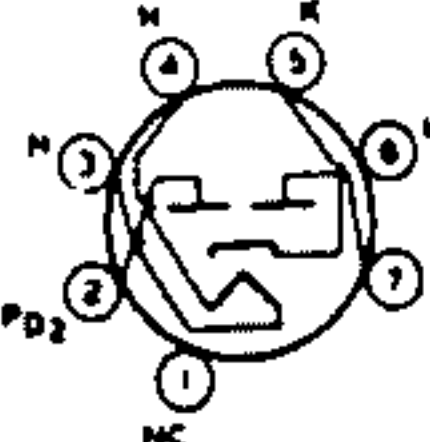
7EW



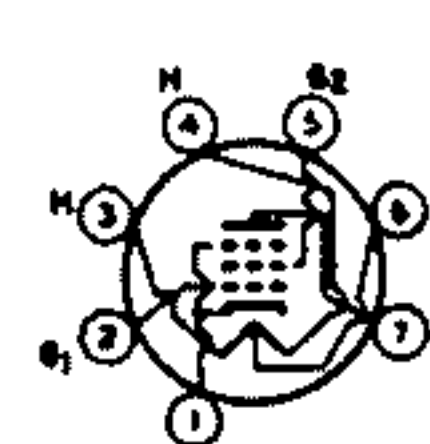
7F



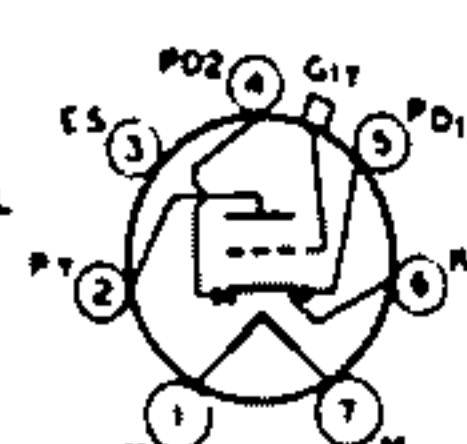
7FB



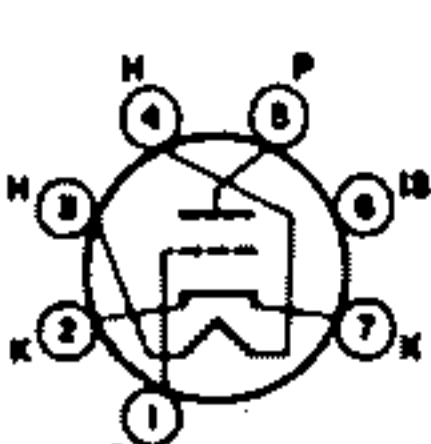
7FL



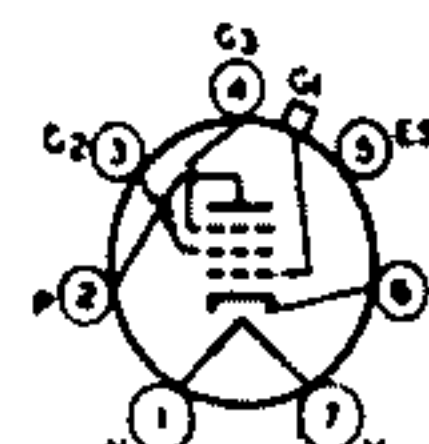
7FZ



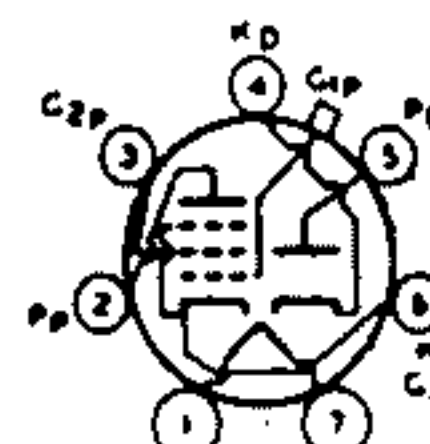
7G



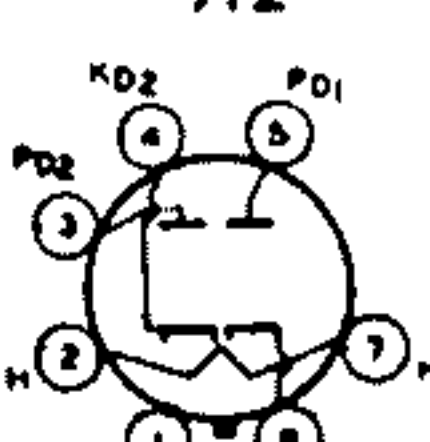
7GM



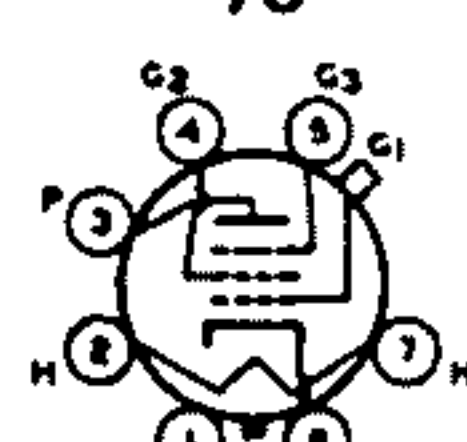
7H



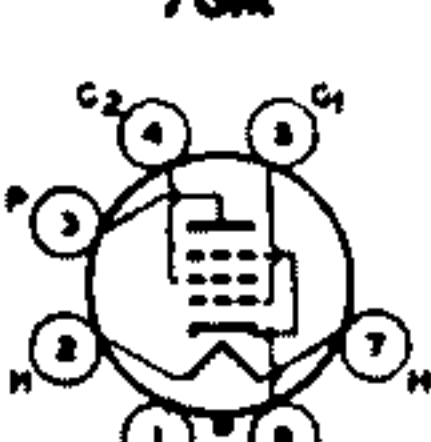
7K



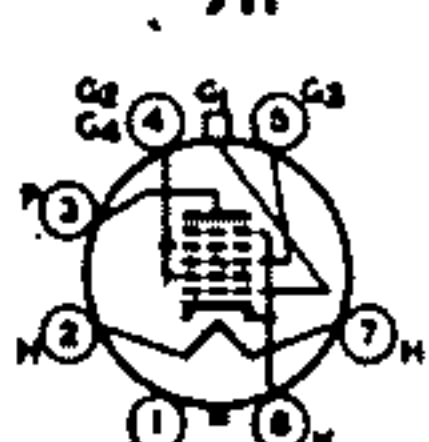
7Q



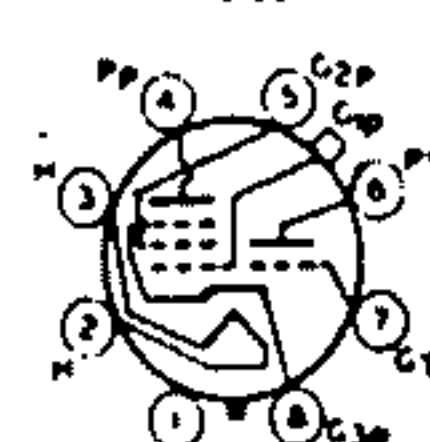
7R



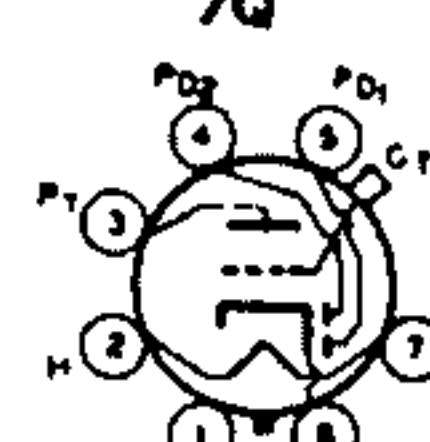
7S



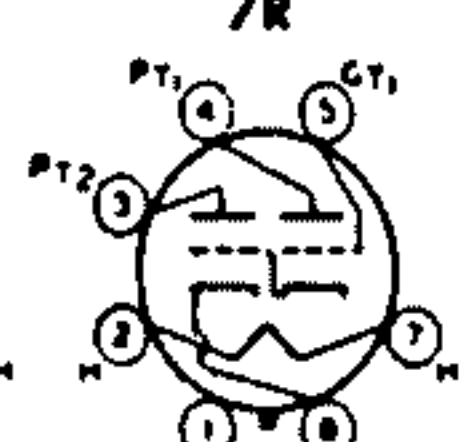
7T



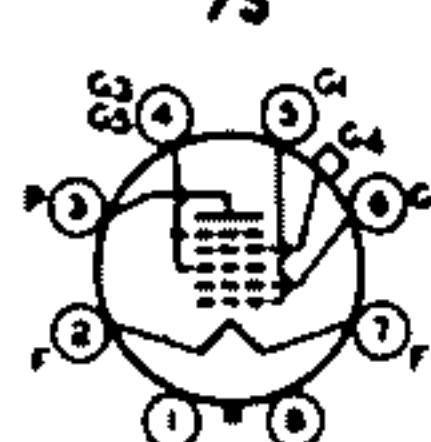
7U



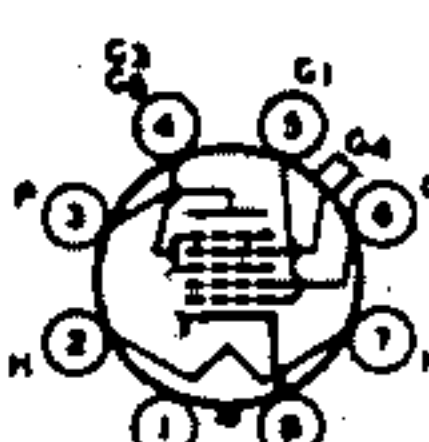
7V



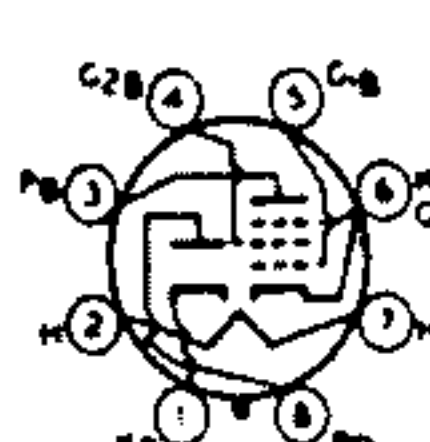
7W



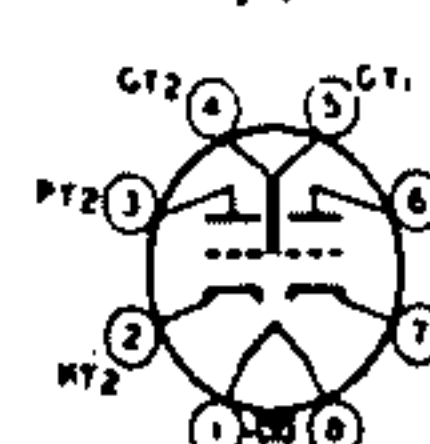
7Z



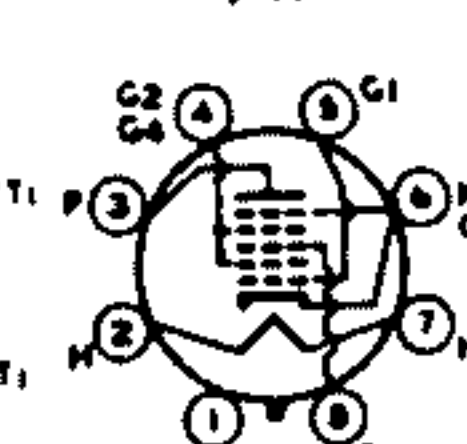
8A



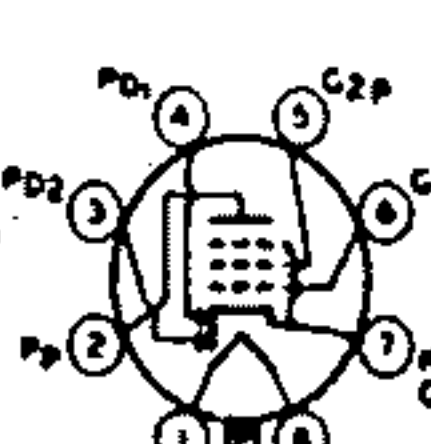
8AA



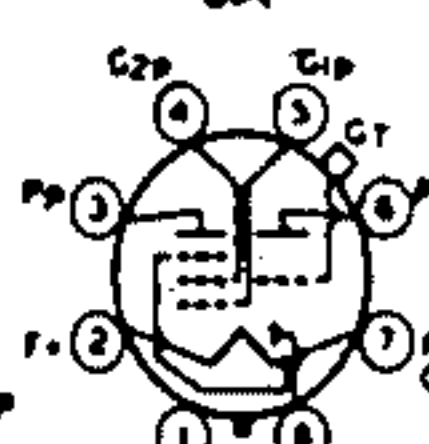
8AC



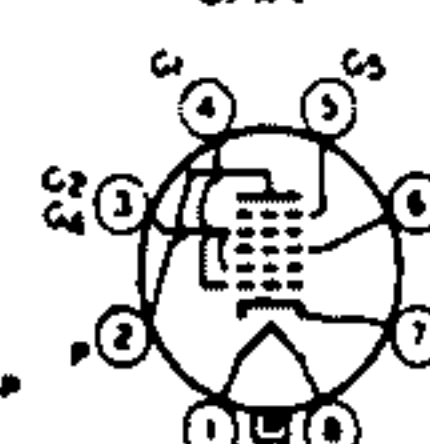
8AD



8AE

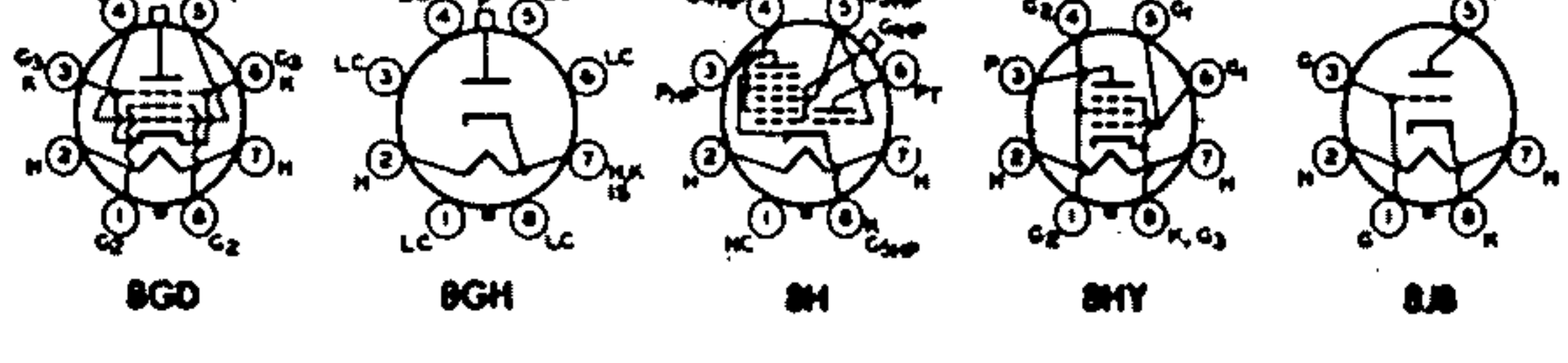
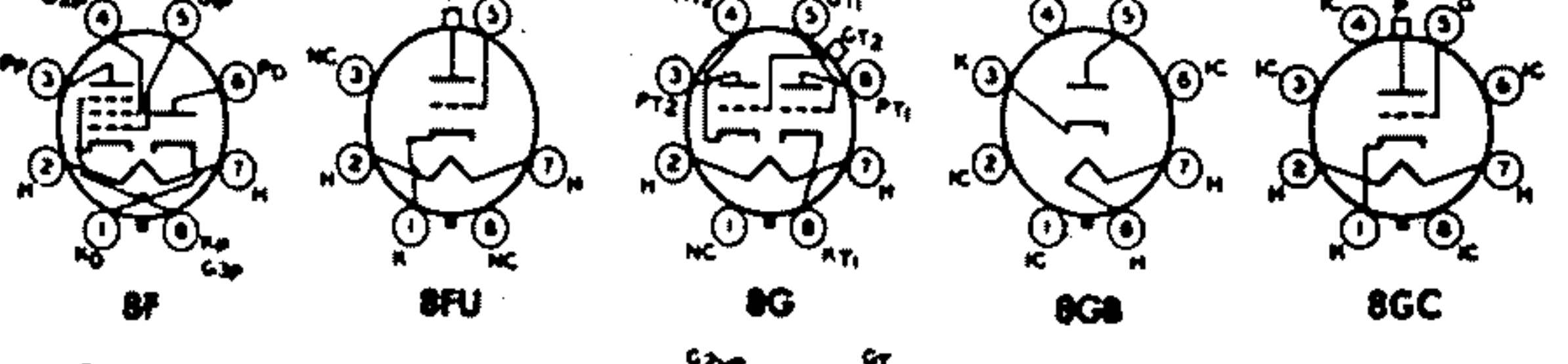
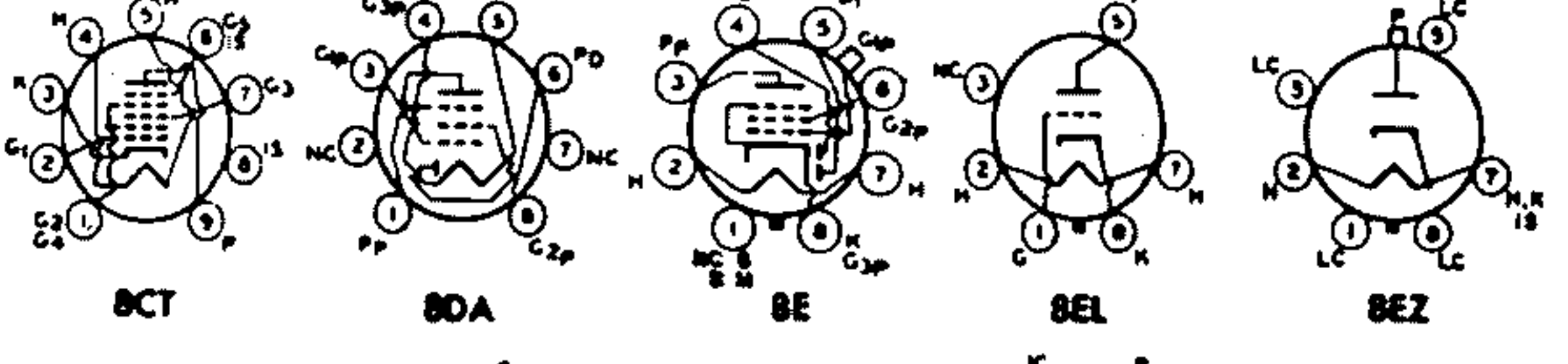
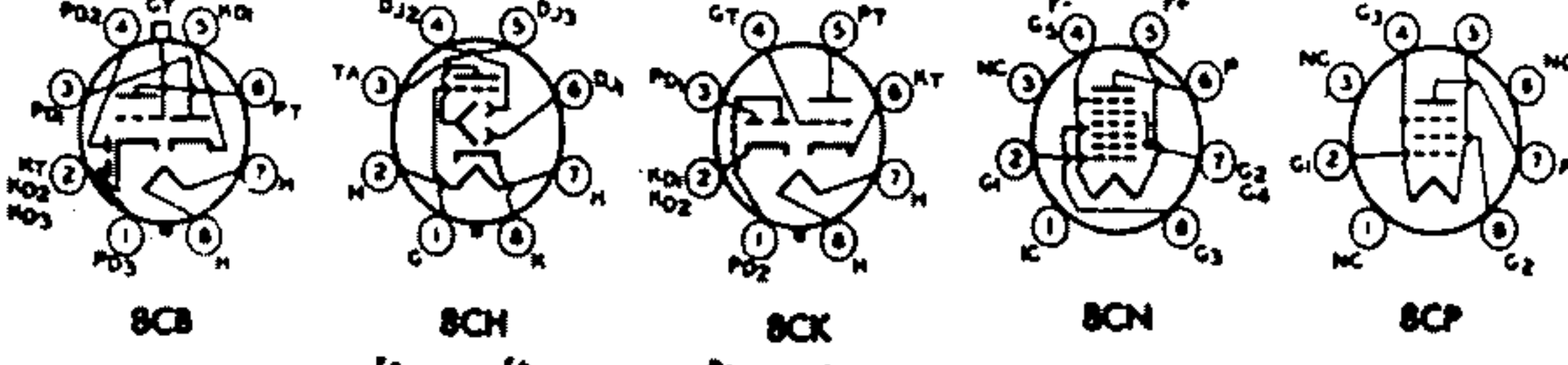
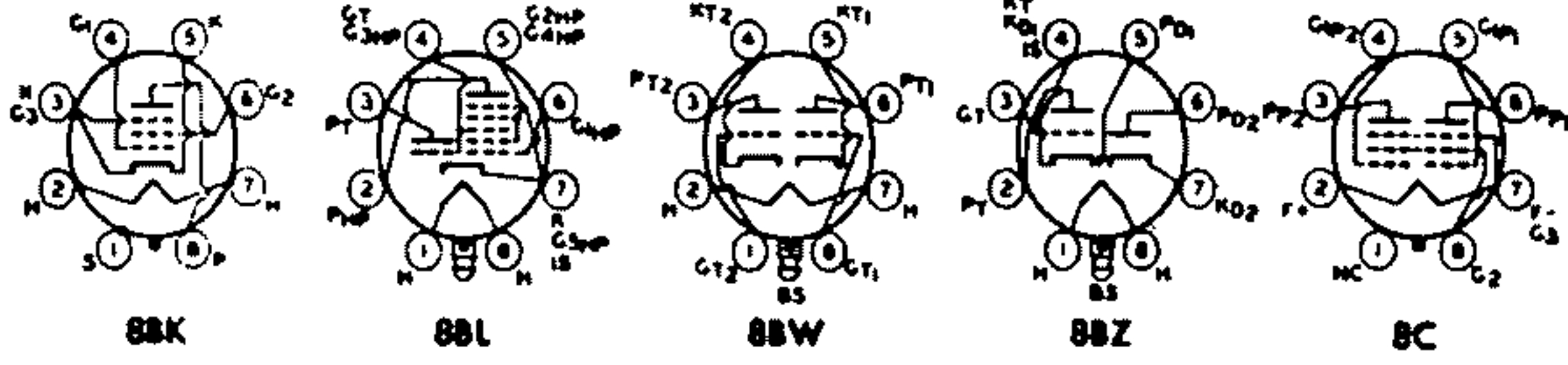
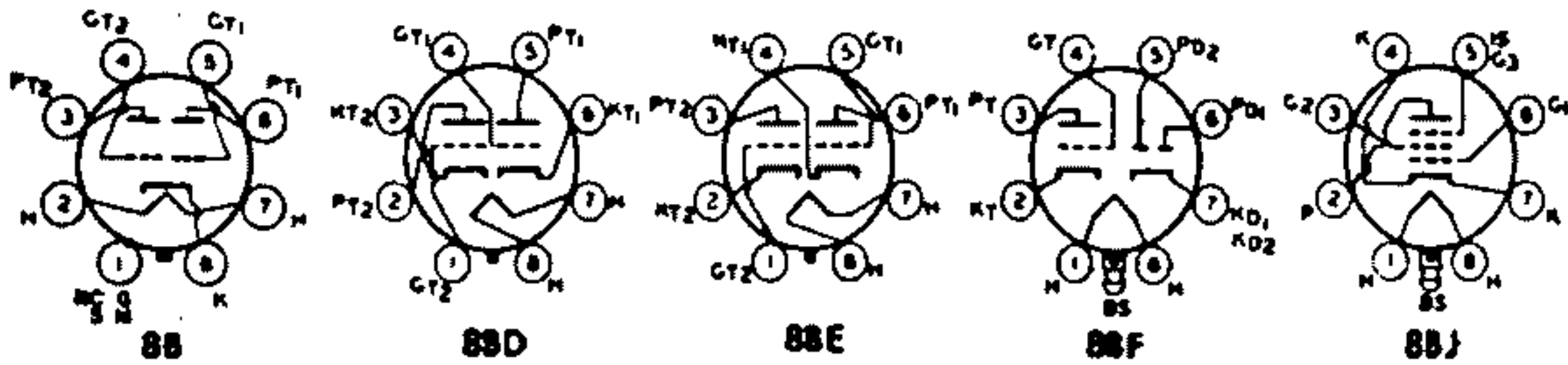
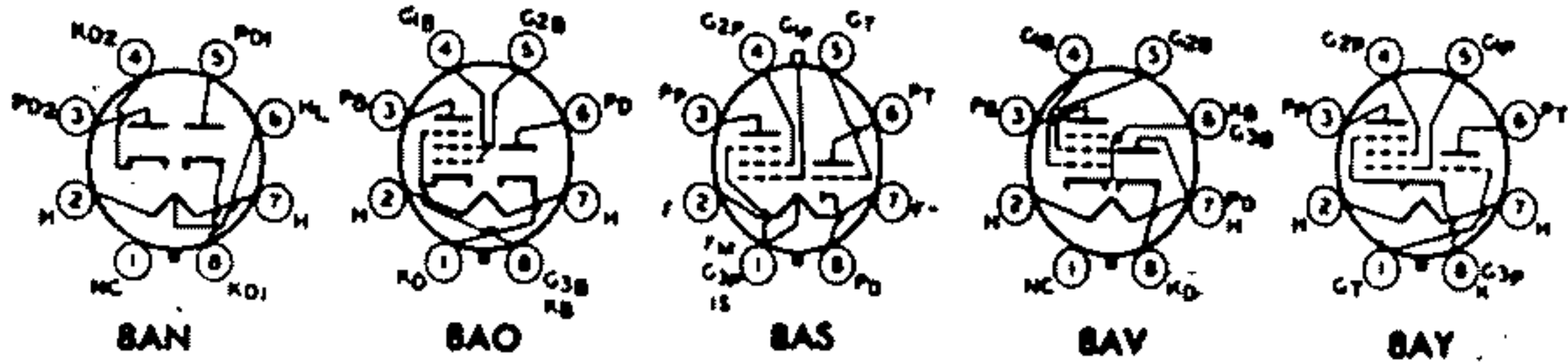


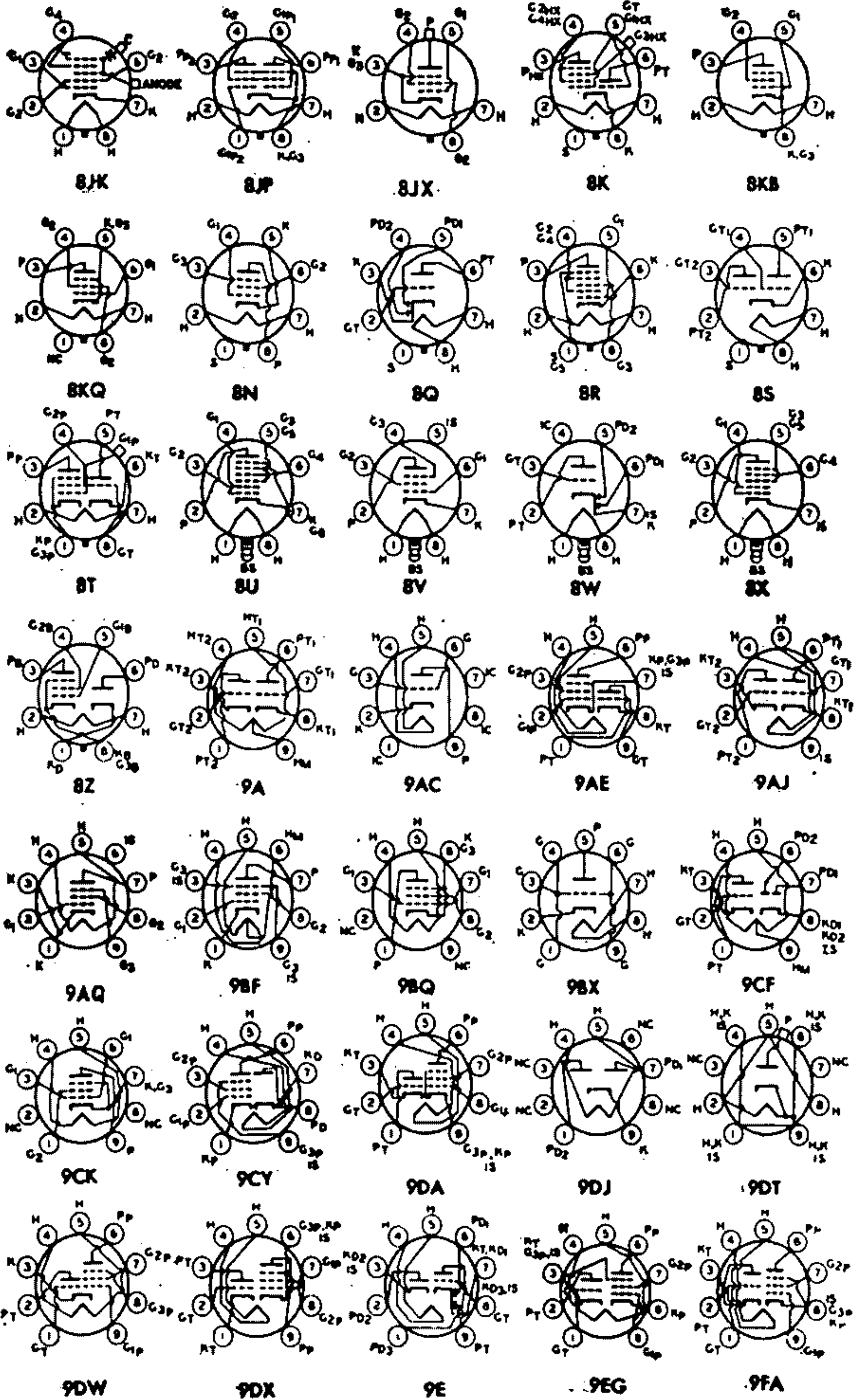
8AJ

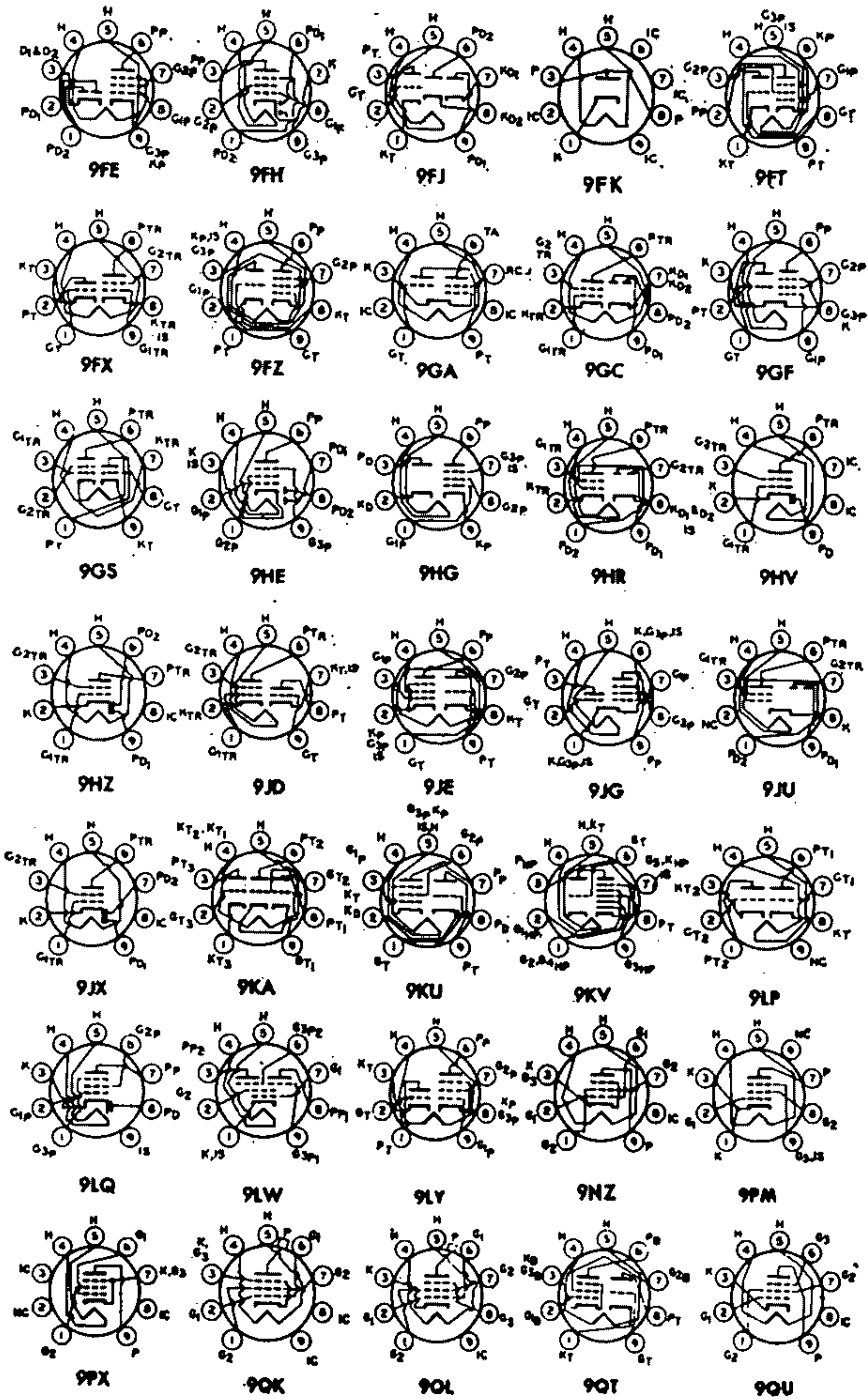


8AL

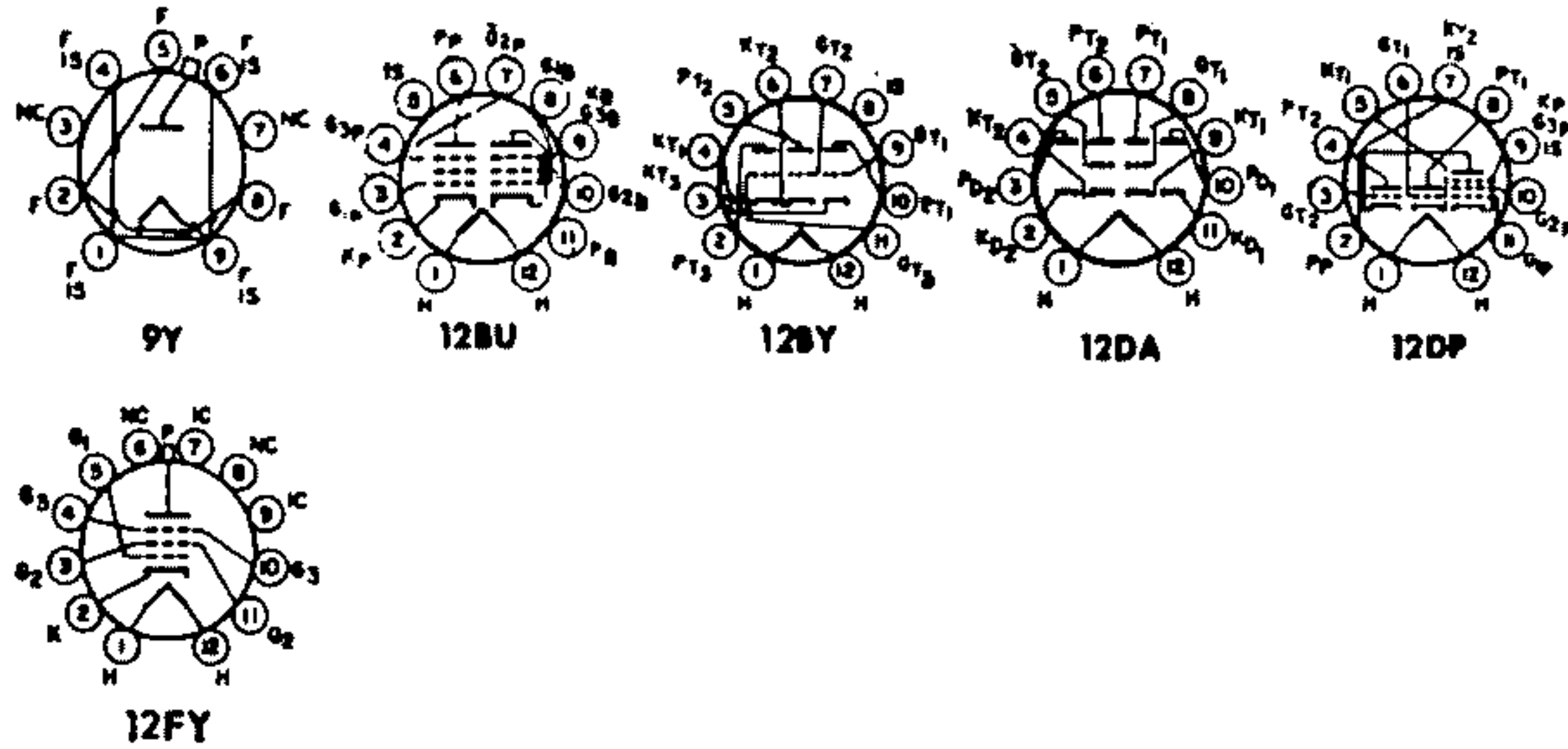






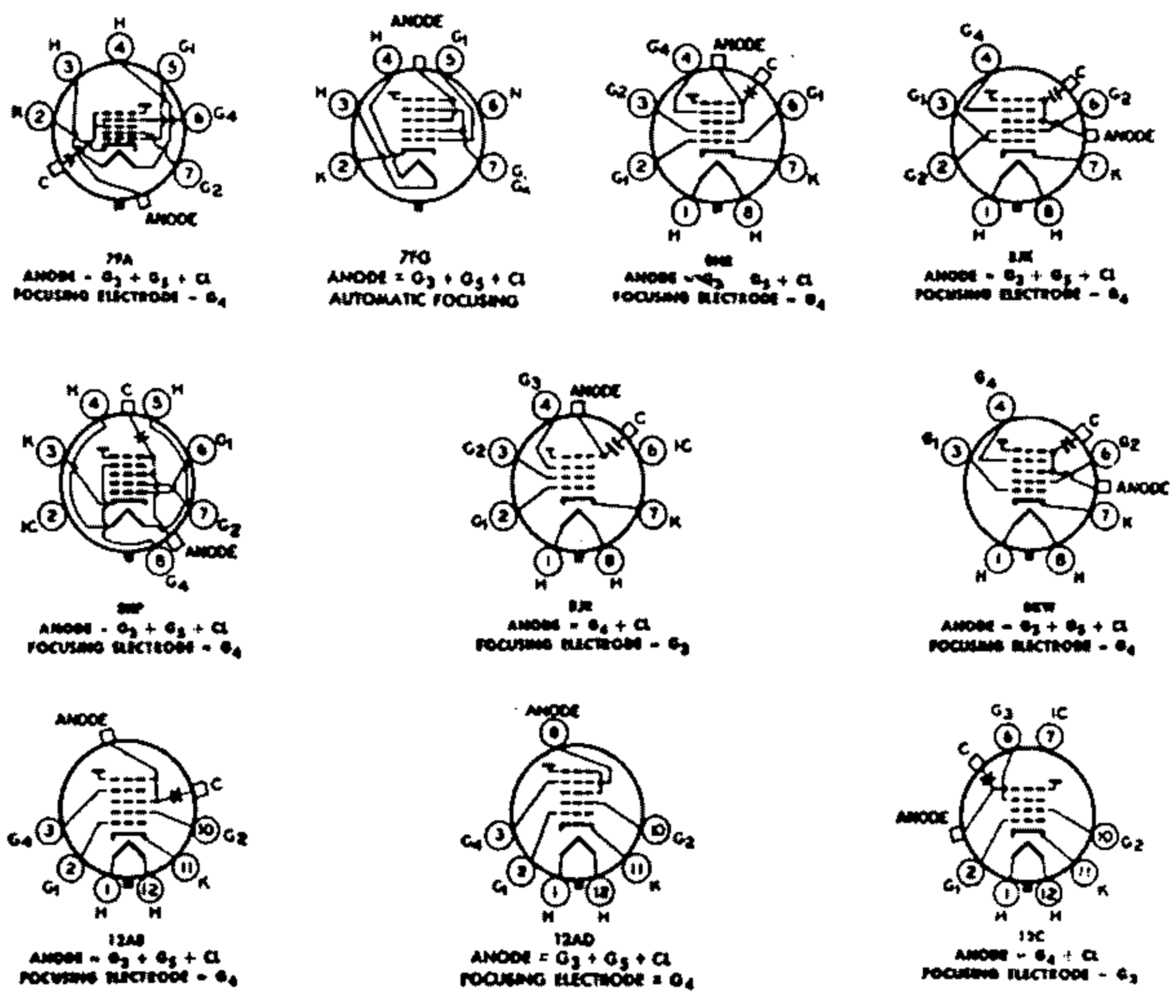


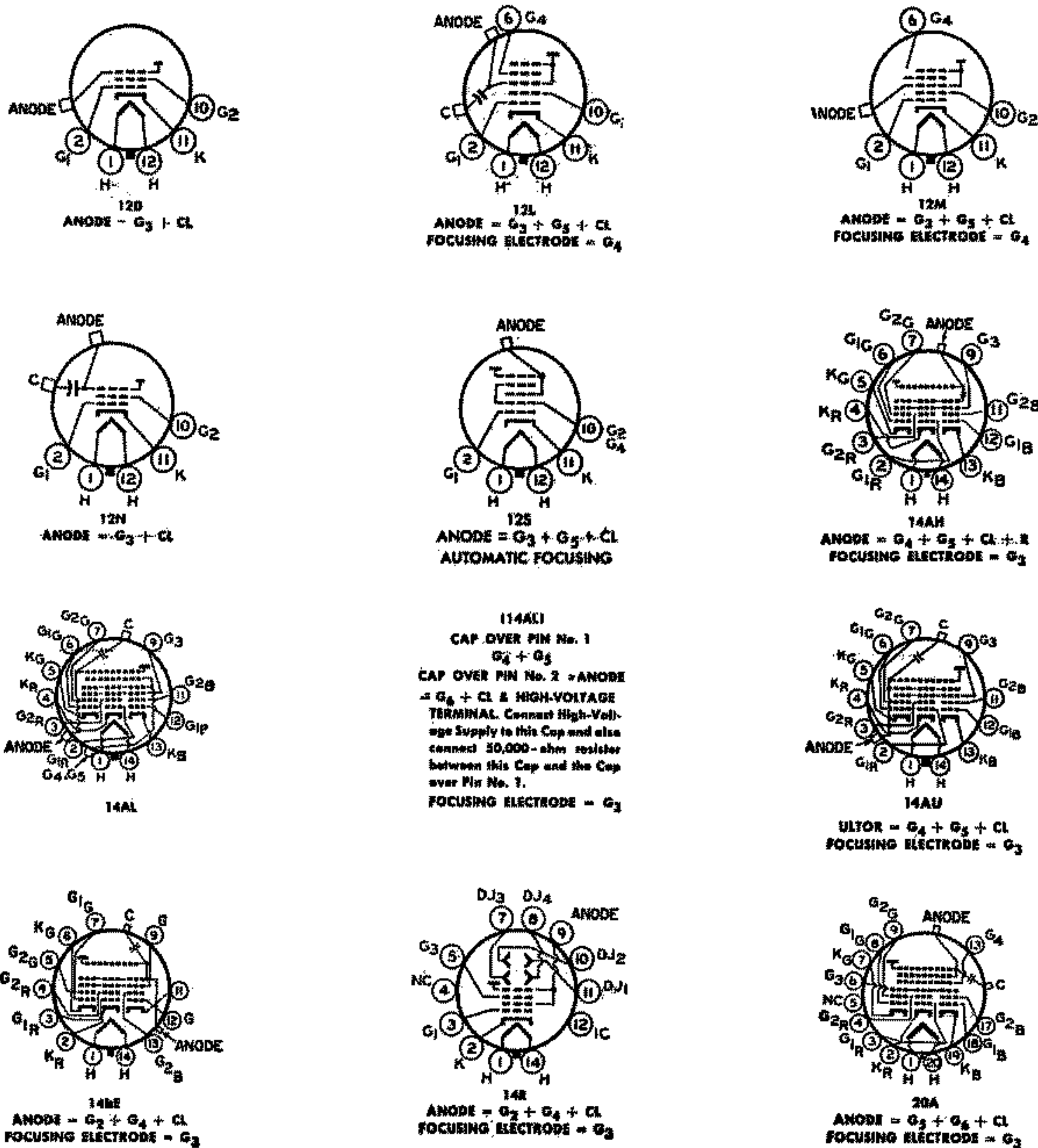




**BASING DIAGRAMS FOR RCA PICTURE TUBES**

(See page 495 for data.)





### Notes for RCA Picture Tube Characteristics Chart

- G Glass round.
- M Metal round.
- G Glass rectangular.
- M Metal rectangular.
- E Electrostatic.
- M Magnetic.

- a Faceplate is spherical, unless otherwise specified.
- b All types utilize magnetic deflection except for type 7JP4 which employs electrostatic deflection.
- c The anode is defined as the electrode, or the electrode in combination with one or more additional electrodes connected within the tube to it, to which is applied the highest dc voltage for

- accelerating the electrons in the beam.
- d Projection type.
- e Typical deflection factors (volts dc/in.) for anode voltage of 6000 volts:  
DJ1 & DJ2 (nearer screen) 186 to 246  
DJ3 & DJ4 (nearer base) 150 to 204
- f Has low grid-No.2 voltage rating: for Cathode-Drive Service.
- g This type has an internal magnetic shield.
- h Cylindrical faceplate.
- i Bipanel type.
- k Treated to reduce specular reflection.

- m PAN-O-PLY—integral implosion protection.
- n This type has a flat, aluminumized, filterglass phosphor-dot screen plate.
- p Three heaters paralleled internally.
- q This type has an integral protective window.
- r Three heaters series connected internally.
- s Automatic.
- t Hi-Lite screen, rare-earth phosphor.
- u Filled-rim-type safety feature.
- v 21-inch round color picture tube similar to 21FBP22.

## RCA PICTURE TUBE CHARACTERISTICS CHART

RCA Type	Aluminized Screen	Heater Volts/mA	Envelope*	Greatest Deflection Angle <sup>b</sup> (Approx.) Degrees	Focusing Method	Approx. Tube Weight Pounds	Maximum Over-all Length Inches	Basing*	Design Maximum Anode <sup>c</sup> Volts	PM Ice-Trap Magnet Required
<b>Silverama Types for Black-and-White TV</b>										
5TP4 <sup>d</sup>	Yes	6.3/600	● G	50	E	1.2	12.125	12C	29500	No
7JP4	No	6.3/600	● G	(e)	E	3	14.875	14R	6500	No
8BP4	No	6.3/600	■ G	90	E	3	10.750	12AB	9000	Yes
9QP4A	No	4.7/300	■ G	70	E	3.5	13.062	12AD	7500	Yes
10BP4A	No	6.3/600	● G	55	M	10	18.000	12N	13000	Yes
10FP4A	Yes	6.3/600	● G	55	M	10	18.000	12N	13000	No
11CP4	Yes	6.3/450	■ G	110	E	4	9.188	8HR	15000	No
11MP4A	Yes	6.3/450	■ G <sup>m</sup>	110	E	4	9.188	8HR	15000	No
11GP4	Yes	6.3/450	■ G <sup>n</sup>	110	E	5	9.035	8HR	15000	No
12BNP4A	Yes	6.3/450	■ G <sup>m</sup>	110	E	5	9.598	8HR	16000	No
12KP4A	Yes	6.3/600	● G	55	M	12	18.000	12N	13000	No
14ATP4	Yes	8.4/450	■ G	90	E	8.5	13.500	12L	15500	No
14CP4B	Yes	6.3/600	■ G	70	M	10.5	16.844	12N	15500	No
14WP4	Yes	6.3/600	■ G	90	E	8.5	13.500	12L	15500	No
16AMP4	Yes	6.3/600	■ G <sup>n</sup>	114	E	9.5	10.750	8HR	18000	No
16AYP4	Yes	6.3/450	■ G	114	E	8.5	10.561	8HR	20000	No
16BGP4	Yes	6.3/450	■ G <sup>m</sup>	114	E	9.5	10.811	8HR	20000	No
16BP4A	Yes	6.3/450	■ G <sup>m</sup>	114	E	9.5	10.811	8HR	20000	No
16CRP4A <sup>f</sup>	No	6.3/600	● G	60	M	15	21.000	12D	16500	Yes
16LP4A	No	6.3/600	● G	52	M	14.5	22.625	12N	15500	Yes
16RP4B	Yes	6.3/600	■ G	70	M	16	19.125	12N	17500	No
16TP4	No	6.3/600	■ G	70	M	16	18.500	12N	15500	Yes
16WP4A	No	6.3/600	● G	70	M	16.5	18.125	12N	17500	Yes
17BIP4	Yes	6.3/600	■ G	90	E	15	15.000	12L	17500	No
17BP4B	Yes	6.3/600	■ G	70	M	18	19.562	12N	17500	No
17CBP4	Yes	8.4/450	■ G	110	E	10	12.812	8HR	17500	No
17CFP4	Yes	6.3/600	■ G	90	E	10	15.375	12L	17500	No
17CP4	No	6.3/600	■ M <sup>h</sup>	70	M	10	19.000	12D	17500	Yes
17CSP4	Yes	6.3/600	■ G	110	E	10	12.625	7FA	17500	No
17CYP4	Yes	6.3/600	■ G	90	E	10	14.375	12L	17500	No
17BAP4	Yes	2.68/450	■ G	110	E	10	10.875	8JK	17500	No
17DKP4	Yes	6.3/600	■ G	110	E	10	10.938	8JR	23000	No
17DQP4 <sup>f</sup>	Yes	6.3/450	■ G	110	E	10	12.375	7FA	17500	No
17DRP4 <sup>g</sup>	Yes	2.68/450	■ G	110	E	10	11.000	8JK	17500	No
17DSP4	Yes	6.3/600	■ G	110	E	10	11.438	8HR	20000	No
17BXP4	Yes	6.30/450	■ G	110	E	10	10.938	8JR	17500	No
17EFP4	Yes	6.30/450	■ G	110	E	10	11.438	8HR	20000	No
17HP4C	Yes	6.3/600	■ G	70	E	18	19.562	12E	17500	No
17LP4B	Yes	6.3/600	■ G <sup>n</sup>	70	E	19	19.562	12L	17500	No
17QP4B	Yes	6.3/600	■ G <sup>n</sup>	70	M	19	19.562	12N	20000	No
17TP4	No	6.3/600	■ M <sup>h</sup>	70	E	10	19.312	12M	17500	Yes
19ABP4	Yes	2.68/450	■ G	114	E	14	11.125	8JK	20000	No
19AMP4	Yes	6.3/450	■ G	114	E	13.5	11.625	8HR	17500	No
19AJP4 <sup>f</sup>	Yes	6.3/450	■ G	114	E	14	11.625	7FA	20000	No
19ANP4	Yes	6.3/600	■ G <sup>n</sup>	114	E	18.5	11.938	8HR	20000	No
19AVP4	Yes	6.3/600	■ G	114	E	14	11.625	8HR	23000	No

\* Basing diagrams for RCA picture tubes are shown on page 493.



## RCA PICTURE TUBE CHARACTERISTICS CHART (Cont'd)

RCA Type	Aluminized Screen	Heater Volts/mA	Envelope*	Greatest Deflection Angle* (Approx.) Degrees	Focusing Method	Approx. Tube Weight Pounds	Maximum Over-all Length Inches	Basing*	Design Maximum Anode* Volts	PM Ion-Trap Magnet Required
<b>Silverama Types for Black-and-White TV</b>										
19AYP4	Yes	6.3/450	■ G	114	E	14	11.625	8HR	23000	No
19BDP4'	Yes	6.3/600	■ G	92	E	15	15.625	12L	20000	No
19BTP4	Yes	6.3/600	■ G	114	E	14	11.062	8JR	23000	No
19CMP4'	Yes	6.3/600	■ G	114	E	14	11.875	8HR	20000	No
19CMP4'	Yes	6.3/450	■ G	114	E	14	11.875	8HR	20000	No
19CXP4'	Yes	6.3/600	■ G	114	E	14	11.875	7FA	20000	No
19DAP4	Yes	6.3/450	■ G <sup>1/2</sup>	114	E	15.5	11.875	8HR	23000	No
19DQP4 -	Yes	6.3/450	■ G <sup>m</sup>	114	E	15	11.875	8HR	23000	No
19DRP4	Yes	6.3/600	■ G <sup>m</sup>	114	E	15	11.875	8HR	23000	No
19DSP4'	Yes	6.3/600	■ G <sup>m</sup>	114	E	15	11.875	8HR	20000	No
19EBP4	Yes	6.3/600	■ G <sup>m</sup>	114	E	16	11.875	8HR	23000	No
19EGP4'	Yes	6.3/450	■ G <sup>m</sup>	114	E	16	11.875	8HR	21000	No
19ENP4A	Yes	6.3/450	■ G <sup>m</sup>	114	E	15	11.875	8HR	21000	No
19FEP4B'	Yes	6.3/450	■ G <sup>m</sup>	114	E	15	11.875	8HR	23500	No
20BP4B	Yes	6.3/600	■ G	70	M	30	22.125	12N	20000	No
20HP4E	Yes	6.3/600	■ G	70	E	30	22.125	12L	17500	No
21AMP4B	Yes	6.3/600	■ G	90	M	24	20.375	12N	20000	No
21AVP4C	Yes	6.3/600	■ G	72	E	24	23.406	12L	22000	No
21AWP4A	Yes	6.3/600	■ G	72	M	24	23.406	12N	20000	No
21CBP4A	Yes	6.3/600	■ G	90	E	24	18.375	12L	22000	No
21CQP4	Yes	6.3/600	■ G	110	E	20	14.812	7FA	20000	No
21DEP4A	Yes	6.3/600	■ G	110	E	20	15.000	8HR	22000	No
21DFP4	Yes	6.3/600	■ G	110	E	23	14.750	8HR	20000	No
21DNP4	Yes	6.3/450	■ G	110	E	20	15.000	8HR	20000	No
21OLP4	Yes	6.3/600	■ G	90	E	24	17.375	12L	22000	No
21BSP4'	Yes	6.3/600	■ G	90	E	24	18.375	12L	22000	No
21EP4C	Yes	6.3/600	■ G <sup>a</sup>	70	M	29	23.406	12N	20000	No
21EQP4	Yes	6.3/600	■ G	110	E	23	12.875	8JR	20000	No
21FAP4	Yes	6.3/600	■ G	110	E	20	13.125	8JR	22000	No
21FDP4	Yes	6.3/600	■ G	110	E	20	13.375	8KW	20000	No
21FP4D	Yes	6.3/600	■ G <sup>a</sup>	70	E	29	23.406	12L	20000	No
21FVP4	Yes	6.3/450	■ G <sup>m</sup>	114	E	19	12.937	8HR	23000	No
21MP4	No	6.3/600	■ M	70	E	18	22.625	12M	17500	Yes
21WP4B	Yes	6.3/600	■ G	70	M	24	22.812	12N	20000	No
21XP4B	Yes	6.3/600	■ G	70	E	24	22.812	12L	20000	No
21YP4B	Yes	6.3/600	■ G	70	E	24	23.406	12L	20000	No
21ZP4C	Yes	6.3/600	■ G	70	M	24	23.406	12N	20000	No
23AMP4	Yes	6.3/600	■ G	92	E	27	18.375	12L	22000	No
23ARP4	Yes	6.3/600	■ G	110	E	25	15.156	8HR	22000	No
23ASP4	Yes	6.3/600	■ G	92	E	27	17.375	12L	22000	No
23BGP4'	Yes	6.3/600	■ G <sup>1</sup>	110	E	33	15.562	8HR	22000	No
23BJP4'	Yes	6.3/600	■ G	92	E	27	18.500	12L	25000	No
23BLP4'	Yes	6.3/600	■ G <sup>1/2</sup>	92	E	35	18.875	12L	25000	No
23BQP4	Yes	6.3/450	■ G <sup>1</sup>	110	E	33	15.562	8HR	23000	No
23CBP4	Yes	6.3/450	■ G <sup>1/2</sup>	110	E	33	15.562	8HR	23000	No
23CGP4	Yes	6.3/450	■ G	92	E	27	18.375	12L	22000	No

\* Basing diagrams for RCA picture tubes are shown on page 493.

RCA PICTURE TUBE CHARACTERISTICS CHART (Cont'd)

RCA Type	Aluminized Screen	Heater Volts/mA	Envelope*	Greatest Deflection Angle <sup>b</sup> (Approx.) Degrees	Focusing Method	Approx. Tube Weight Pounds	Maximum Over-all Length Inches	Basing*	Design Maximum Anode <sup>c</sup> Volts	PM Ion-Trap Magnet Required
<b>Silverama Types for Black-and-White TV</b>										
23CP4	Yes	6.3/600	■ G'	110	E	33	15.562	8HR	22000	No
23CBP4	Yes	6.3/450	■ G	114	E	24	14.062	8HR	23500	No
23DAP4'	Yes	6.3/600	■ G	94	E	27	17.391	8HR	23000	No
23DBP4'	Yes	6.3/600	■ G	110	E	25	15.156	8HR	22000	No
23EXP4	Yes	6.3/450	■ G <sup>m</sup>	92	E	29	18.375	12L	25000	No
23ENP4'	Yes	6.3/600	■ G <sup>m</sup>	92	E	29	18.500	12L	25000	No
23EP4'	Yes	6.3/600	■ G'	110	E	33	15.562	8KP	22000	No
23EBP4	Yes	6.3/450	■ G <sup>m</sup>	114	E	28	14.812	8HR	23000	No
23ETP4	Yes	6.3/600	■ G <sup>m</sup>	110	E	28	15.156	8HR	23000	No
23FBP4'	Yes	6.3/600	■ G <sup>m</sup>	92	E	29	18.500	12L	25000	No
23FP4A	Yes	6.3/600	■ G	114	E	24	14.062	8HR	23500	No
23FRP4'	Yes	6.3/450	■ G <sup>m</sup>	110	E	29	14.531	8HR	23000	No
23FSP4	Yes	6.3/600	■ G <sup>m</sup>	110	E	29	15.156	8HR	23000	No
23GJP4A	Yes	6.3/450	■ G <sup>m</sup>	110	E	28	14.531	8HR	23000	No
23HFP4A	Yes	6.3/450	■ G <sup>m</sup>	110	E	28	15.156	8HR	23000	No
23HUP4A'	Yes	6.3/450	■ G <sup>m</sup>	110	E	28	14.656	8HR	23500	No
23JP4'	Yes	6.3/450	■ G'	110	E	33	15.875	7FA	22000	No
23NP4'	Yes	6.3/600	■ G	114	E	24	14.812	8HR	22000	No
23YP4	Yes	6.3/600	■ G'	92	E	35	18.750	12L	22000	No
24AEP4	Yes	6.3/600	■ G	90	E	32.5	19.500	12L	22000	No
24AHP4	Yes	6.3/600	■ G	110	E	26.5	16.188	8HR	22000	No
24ATP4'	Yes	6.3/600	■ G	90	E	32.5	19.500	12L	22000	No
24AUP4	Yes	6.3/600	■ G	90	E	32.5	18.500	12L	22000	No
24BAP4'	Yes	6.3/600	■ G	110	E	26.5	16.188	8HR	22000	No
24BEP4	Yes	6.3/600	■ G	110	E	26.5	15.125	8KW	20000	No
24CP4B	Yes	6.3/600	■ G	90	M	32.5	21.500	12N	22000	No
27MP4	Yes	6.3/600	■ M	90	M	30	22.188	12D	20000	Yes
27RP4A	Yes	6.3/600	■ G	90	M	44	23.438	12N	22000	No
<b>Color Picture Tubes</b>										
15GP22 <sup>a</sup>	Yes	6.3/1800 <sup>a</sup>	● G	45	E	25	26.125	20A	22000	No
19EXP22'	Yes	6.3/800 <sup>a</sup>	■ G	90	E	21	18.231	14BE	27500	No
19EYP22'	Yes	6.3/800 <sup>a</sup>	■ G <sup>ab</sup>	90	E	24	18.423	14BE	27500	No
21AXP22A	Yes	6.3/1800 <sup>a</sup>	● M	70	E	28	25.312	14AH	27500	No
21CYP22A	Yes	6.3/1800 <sup>a</sup>	● G	70	E	36.5	25.406	14AL	27500	No
21FBP22	Yes	6.3/1800 <sup>a</sup>	● G	70	E	36.5	25.406	14AU	27500	No
21FBP22A'	Yes	6.3/1800 <sup>a</sup>	● G	70	E	36.5	25.406	14AU	27500	No
21FJP22	Yes	6.3/1800 <sup>a</sup>	● G <sup>ac</sup>	70	E	41	25.594	14AU	27500	No
21FJP22A'	Yes	6.3/1800 <sup>a</sup>	● G <sup>ac</sup>	70	E	41	25.594	14AU	27500	No
25AP22A'	Yes	6.3/800 <sup>a</sup>	■ G <sup>ac</sup>	90	E	42	21.299	14BE	27500	No
25BP22A'	Yes	6.3/800 <sup>a</sup>	■ G	90	E	37	21.107	14BE	27500	No
<b>Test Picture Tubes</b>										
5AXP4	No	6.3/600	● G	53	E'	1.5	11.000	12S	20000	No
8XP4	Yes	6.3/600	■ G	90	E'	3	11.750	12S	22000	No
8YP4	Yes	6.3/600	■ G	110	E'	2	9.000	7FG	22000	No
1028P22 <sup>a</sup>	Yes	6.3/1800 <sup>a</sup>	● G	70	E	36.5	25.406	14AU	27500	No

\* Basing diagrams for RCA picture tubes are shown on page 483.

## RCA VOLTAGE-REGULATOR AND VOLTAGE-REFERENCE TUBES

*These tubes are designed for voltage-regulation requiring a relatively constant dc output voltage across a load independent of load and line-voltage variations.*

RCA Type	DC Operating Volts	DC Operating Current Range mA	Anode Starting Volts	Anode Starting (mA)	Regulation Volts	Ambient Operating Temperature Range (°C)	Max Length (in)	Max Diameter (in)	Diagram Terminal
<b>VOLTAGE-REGULATOR TUBES †</b>									
0A2	150	5 to 30	185	75	6	-55 to +90	2-5/8	3/4	5B0
0A3	75	5 to 40	105	100	6.5	-55 to +90	4-1/8	1-9/16	4AJ
0A3A	75	5 to 40	105	100	6.5	-55 to +90	3-1/16	1-9/32	4AJ
0B2	105	5 to 30	133	75	4	-55 to +90	2-5/8	3/4	5B0
0C2	75	5 to 30	115	75	4.5	-55 to +90	2-5/8	3/4	5B0
0C3	105	5 to 40	133	100	4	-55 to +90	4-1/8	1-9/16	4AJ
0C3A	105	5 to 40	127	100	4	-55 to +90	3-1/16	1-9/32	4AJ
0D3	150	5 to 40	185	100	5.5	-55 to +90	4-1/8	1-9/16	4AJ
0D3A	150	5 to 40	180	100	5.5	-55 to +90	3-1/16	1-9/32	4AJ
991	59	0.4 to 2	87	—	8	—	1-9/16	5/8	*
6073	150	5 to 30	185	75	6	-55 to +90	2-5/8	3/4	5B0
6073/0A2	150	5 to 30	185	75	6	-55 to +90	2-5/8	3/4	5B0
6074	105	5 to 30	133	75	4	-55 to +90	2-5/8	3/4	5B0
6074/0B2	105	5 to 30	133	75	4	-55 to +90	2-5/8	3/4	5B0
6076/0AZWA	150	5 to 30	165	75	5	-55 to +90	2-5/8	3/4	5B0

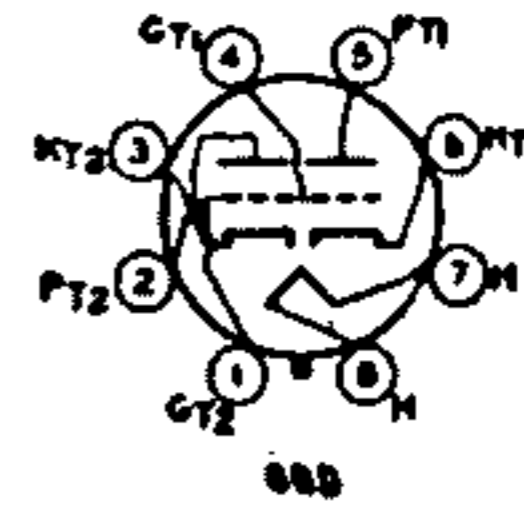
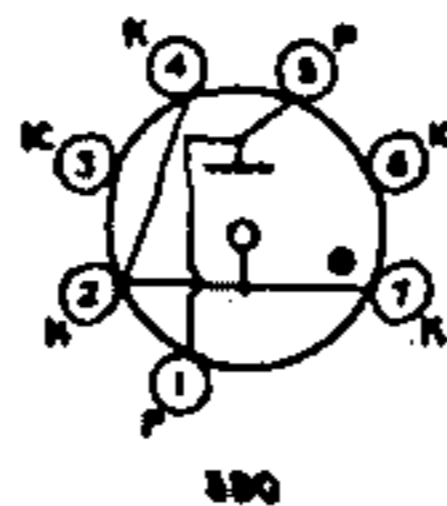
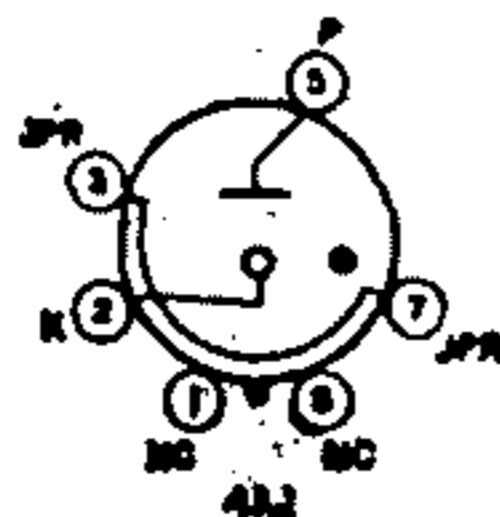
<b>VOLTAGE-REFERENCE TUBES †</b> (for exceptional voltage stability)									
5051	87	1.5 to 3.5	115	—	3	-55 to +90	2-1/8	3/4	5B0
5051A	85.5	1.5 to 3.5	115	—	3	-55 to +90	2-1/8	3/4	5B0

<b>SERIES-VOLTAGE-REGULATOR TUBES **</b> (for high-current applications)										
RCA Type	Heater Volts	Heater Amperes	DC Plate Volts	DC Plate Amperes	Plate Dissipation (watts)	Amplification Factor	Plate Resistance (ohms)	Max Length (in)	Max Diameter (in)	Terminal Diagram
6336A	6.3	2.5	250	0.125	13	2	280	4-5/8	1-9/16	8B0
6A57B	6.3	2.5	250	0.125	13	2	280	4-1/6	1-23/32	8B0
8080	26.5	0.6	250	0.125	13	2	280	4-1/6	1-23/32	8B0
8082	6.3	5	400	0.4	30	2.7	280	4-3/4	2.07	8B0

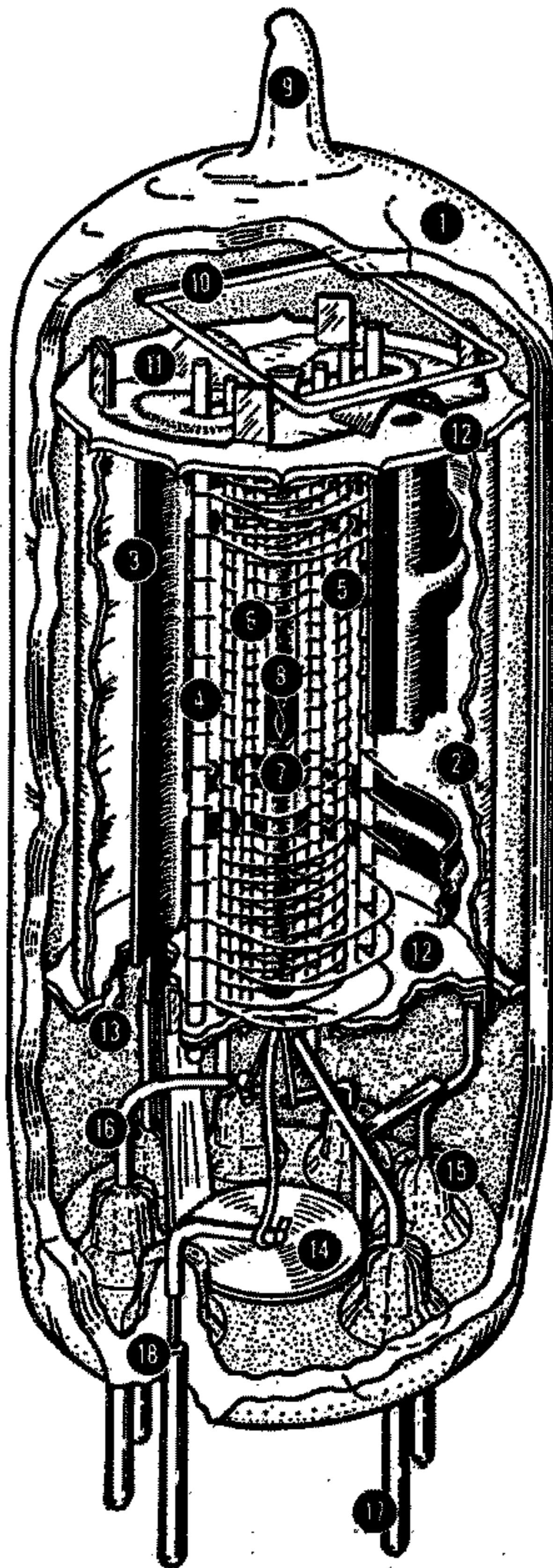
\*\* Indirectly-heated-cathode, vacuum, low-mu twin triodes.

\* Candelabra two-contact socket.

† Cold-cathode, glow-discharge types.







- 1—Glass Envelope
- 2—Internal Shield
- 3—Plate
- 4—Grid No. 3 (Suppressor)
- 5—Grid No. 2 (Screen)
- 6—Grid No. 1 (Control Grid)
- 7—Cathode
- 8—Heater
- 9—Exhaust Tip
- 10—Getter
- 11—Spacer Shield Header
- 12—Insulating Spacer
- 13—Spacer Shield
- 14—Inter-Pin Shield
- 15—Glass Button-Stem Seal
- 16—Lead Wire
- 17—Base Pin
- 18—Glass-to-Metal Seal

**Structure of a Miniature Tube**

# Electron Tube Testing

**T**HE electron-tube user-service man, experimenter, or non-technical radio listener—is interested in knowing the condition of his tubes, since they govern the performance of the device in which they are used. In order to determine the condition of a tube, some method of test is necessary. Because the operating capabilities and design features of a tube are indicated and described by its electrical characteristics, a tube is tested by measuring its characteristics and comparing them with values established as standard for that type. Tubes which read abnormally high with respect to the standard for the type are subject to criticism just the same as tubes which are too low.

Certain practical limitations are placed on the accuracy with which a tube test can be correlated with actual tube performance. These limitations make it impractical for the service man and dealer to employ complex and costly testing equipment having laboratory accuracy. Because the accuracy of the tube-testing device need be no greater than the accuracy of the correlation between test results and receiver performance, and since certain fundamental characteristics are virtually fixed by the manufacturing technique of leading tube manufacturers, it is possible to employ a relatively simple test in order to determine the serviceability of a tube.

In view of these factors, dealers and service men will find it economically expedient to obtain adequate accuracy and simplicity of operation by employing a device which indicates the status of a single characteristic. Whether the tube is satisfactory or unsatisfactory is judged from the test result of this single characteristic. Consequently, it is

very desirable that the characteristic selected for the test be one which is truly representative of the tube's over-all condition.

The following information and circuits are given to describe and illustrate general theoretical and practical tube-tester considerations and not to provide information on the construction of a home-made tube tester. In addition to the problem of determining what tube characteristic is most representative of performance capabilities in all types of receivers, the designer of a home-made tester faces the difficult problem of determining satisfactory limits for his particular tester. Getting information of this nature, if it is to be accurate and useful, is a big job. It requires the testing of many tubes of each type, testing of many types, and correlation of the data with performance in many kinds of equipment.

## Short-Circuit Test

The fundamental circuit of a short-circuit tester is shown in Fig. 129. Although this circuit is suitable for test-

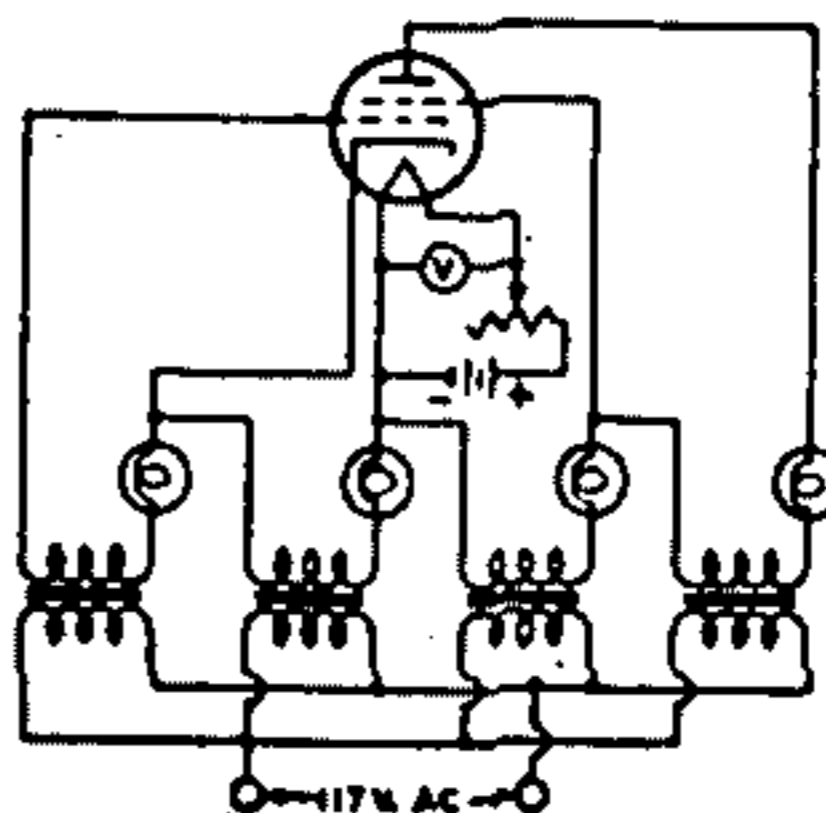


Fig. 129—Fundamental circuit of a short-circuit tester.

rodes and types having less than four electrodes, tubes of more electrodes may be tested by adding more indicator lamps to the circuit. Voltages are applied between the various electrodes with lamps in series with the electrode leads. The value of the voltages applied will depend on the type of tube being tested and its maximum ratings. Any two shorted electrodes complete a circuit and light one or more lamps. Since two electrodes may be just touching to give a high-resistance short, it is desirable that the indicating lamps operate on very low current. It is also desirable to maintain the filament or heater of the tube at its operating temperature during the short-circuit test, because short-circuits in a tube may sometimes occur only when the electrodes are heated. However, a short-circuit tester having too high a sensitivity may indicate very-high-resistance shorts that do not adversely affect tube operation.

### Selection of a Suitable Characteristic for Test

Some characteristics of a tube are far more important in determining its operating worth than are others. The cost of building a device to measure any one of the more important characteristics may be considerably higher than that of a device which measures a less representative characteristic. Consequently, three methods of test will be discussed, ranging from relatively simple and inexpensive equipment to more elaborate, more accurate, and more costly devices.

An **emission test** is perhaps the simplest method of indicating a tube's condition. (Refer to *Diodes*, in *Electrons, Electrodes, and Electron Tubes* section, for a discussion of electron emission.) Since emission falls off as the tube wears out, low emission is indicative of the end of tube serviceability. However, the emission test is subject to limitations because it tests the tube under static conditions and does not take into account the actual operation of the tube. On the one hand, coated filaments, or cathodes,

often develop active spots from which the emission is so great that the relatively small grid area adjacent to these spots cannot control the electron stream. Under these conditions, the total emission may indicate the tube to be normal although the tube is unsatisfactory. On the other hand, coated types of filaments are capable of such large emission that the tube will often operate satisfactorily after the emission has fallen far below the original value.

Fig. 130 shows the fundamental circuit diagram for an emission test. All of the electrodes of the tube, except the cathode, are connected to the plate. The filament, or heater, is operated at rated voltage; after the tube has reached con-

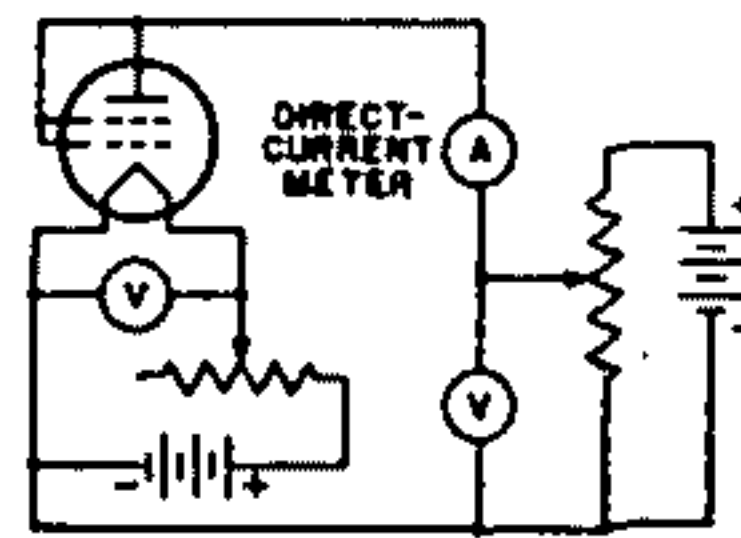


Fig. 130—Fundamental circuit of an emission tester

stant temperature, a low positive voltage is applied to the plate and the electron emission is read on the meter. Readings which are well below the average for a particular tube type indicate that the total number of available electrons has been so reduced that the tube is no longer able to function properly.

A **transconductance test** takes into account a fundamental operating principle of the tube. (This fact will be seen from the definition of transconductance in the Section on **Electron Tube Characteristics**.) It follows that transconductance tests, when properly made, permit better correlation between test results and actual performance than does a straight emission test.

There are two forms of transconductance test which can be utilized in a tube tester. In the first form (illustrated by Fig. 131 giving a fundamental circuit with a tetrode under test), appropriate operating voltages are applied to the electrodes of the tube. A plate current



depending upon the electrode voltages will then be indicated by the meter. If the bias on the grid is then shifted by the application of a different grid voltage, a new plate-current reading is obtained. The difference between the two plate-current readings is indicative of the transconductance of the tube. This

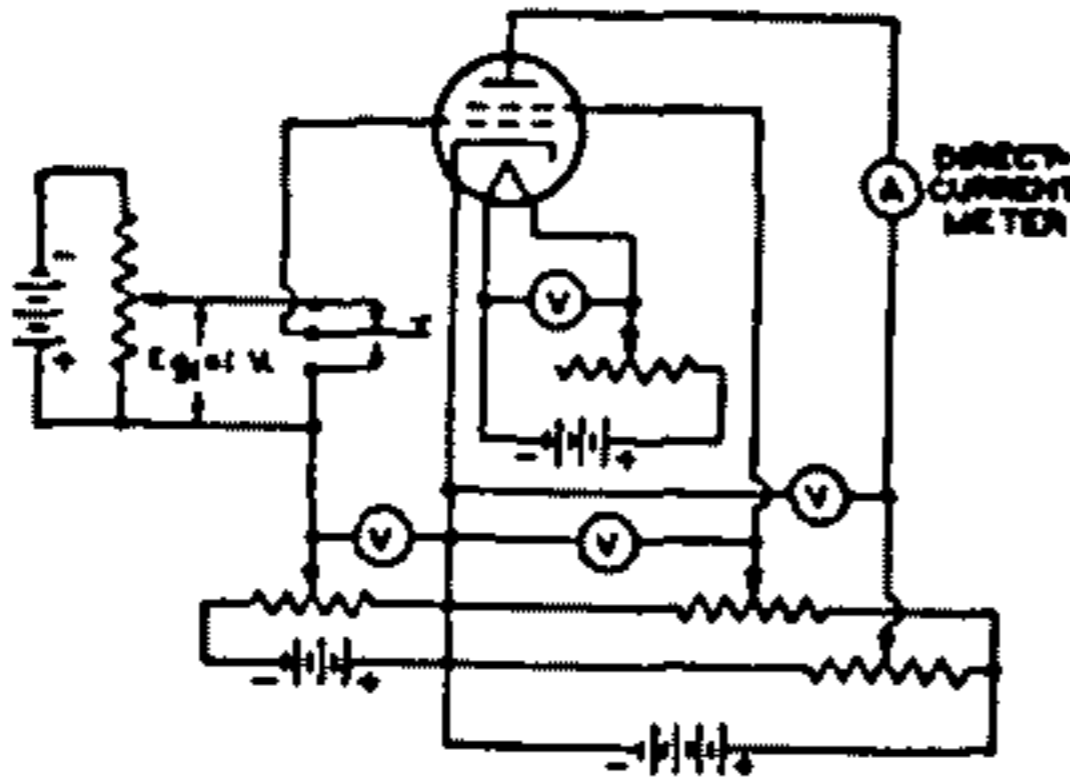


Fig. 131—Fundamental circuit of a transconductance tester using the "grid-shift" method.

method of transconductance testing is commonly called the "grid-shift" method, and depends on readings under static conditions. The fact that this form of test is made under static conditions imposes limitations not encountered in the second form of test made under dynamic conditions.

The dynamic transconductance test illustrated in Fig. 132 gives a fundamental circuit with a tetrode under test. This method is superior to the static transconductance test in that ac voltage

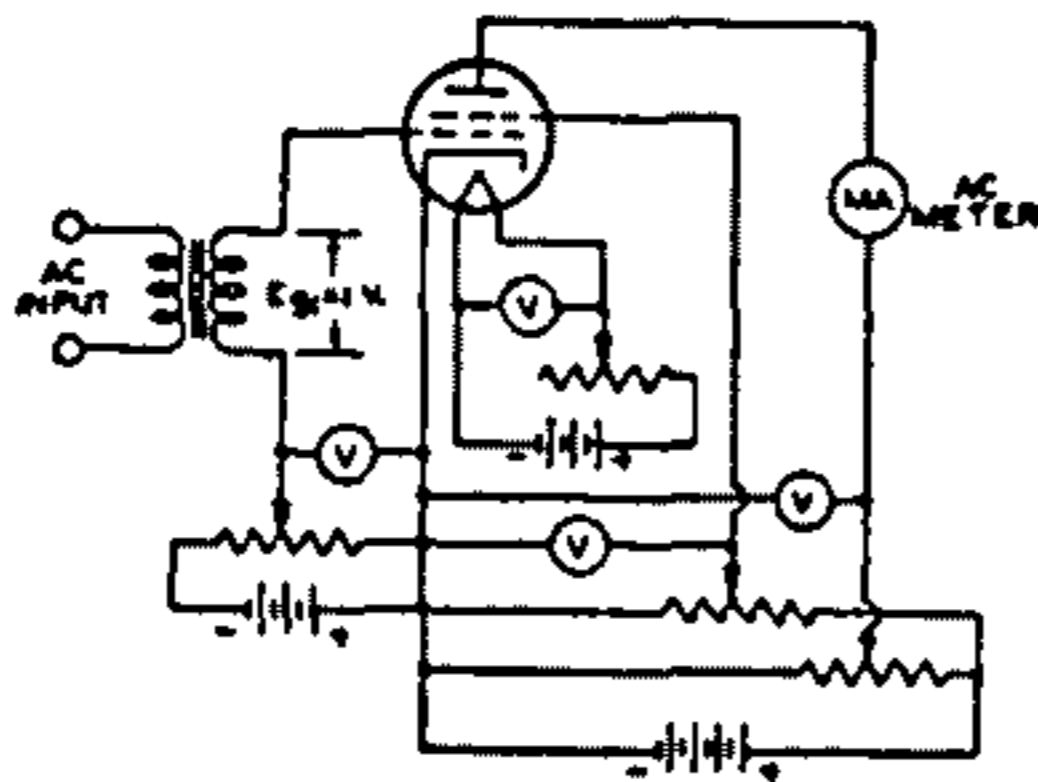


Fig. 132—Fundamental circuit of a dynamic transconductance tester.

is applied to the grid. Thus, the tube is tested under conditions which approximate actual operating conditions. The alternating component of the plate cur-

rent is read by means of an ac ammeter of the dynamometer type. The transconductance of the tube is equal to the ac plate current divided by the input-signal voltage. If a one-volt rms signal is applied to the grid, the plate-current-meter reading in milliamperes multiplied by one thousand is the value of transconductance in micromhos.

The power-output test probably gives the best correlation between test results and actual operating performance of a tube. In the case of voltage amplifiers, the power output is indicative of the amplification and output voltages obtainable from the tube. In the case of power-output tubes, the performance of the tube is closely checked. Consequently, although more complicated to set up, the power-output test will give closer correlation with actual performance than any other single test.

Fig. 133 shows the fundamental circuit of a power-output test for class A operation of tubes. The diagram illustrates the method for a pentode. The ac output voltage developed across the

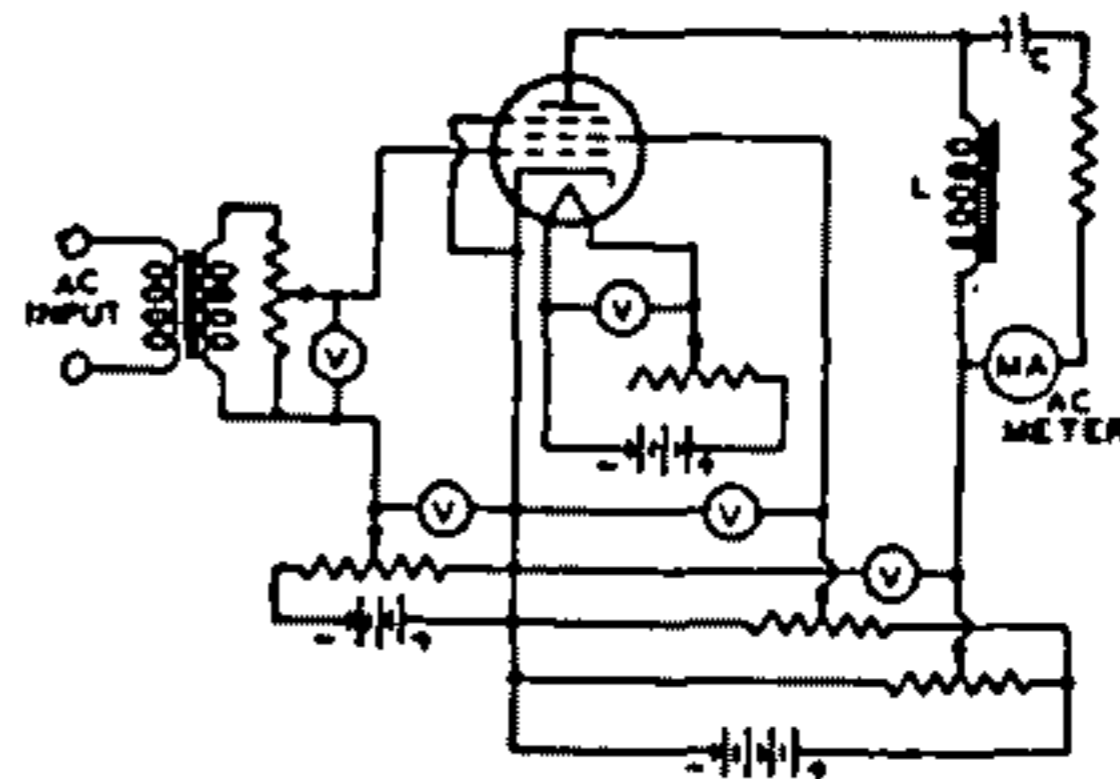


Fig. 133—Fundamental circuit of a power-output tester for class A operation of tubes.

plate-load impedance (L) is indicated by the current meter. The current meter is isolated as far as the dc plate current is concerned by the capacitor (C). The power output can be calculated from the current reading and known load resistance. In this way, it is possible to determine the operating condition of the tube quite accurately.

Fig. 134 shows the fundamental circuit of a power-output test for class B operation of tubes. With ac voltage

applied to the grid of the tube, the current in the plate circuit is read on a dc milliammeter. The power output of the tube is approximately equal to:

$$(I_b^2 \times R_L)/0.405,$$

where  $P_o$  is the power output in watts,  $I_b$  is the dc current in amperes, and  $R_L$  is the load resistance in ohms.

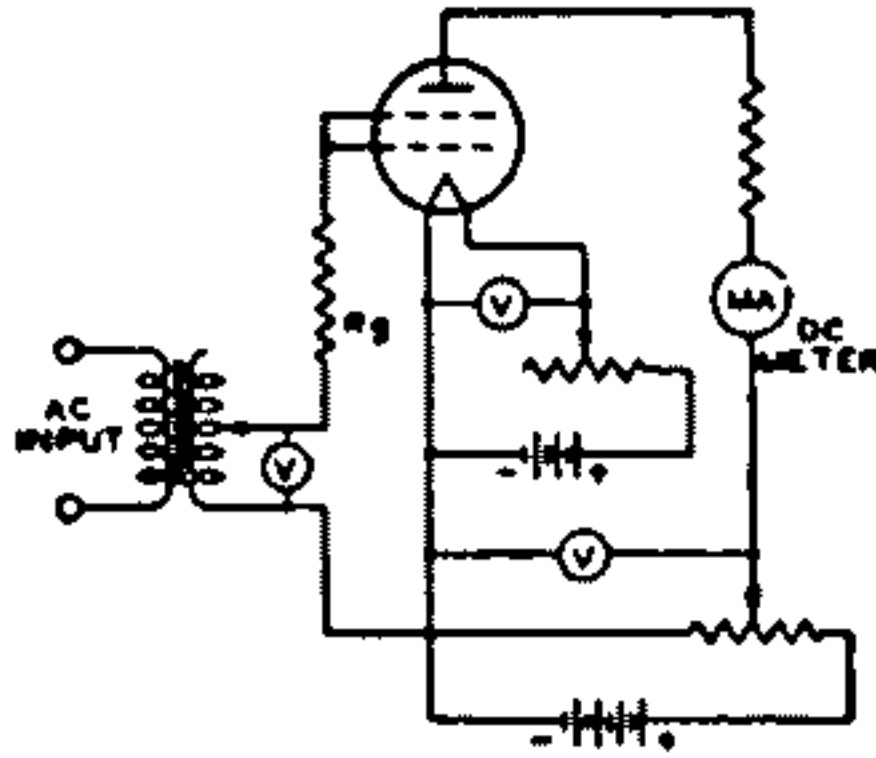


Fig. 134—Fundamental circuit of a power-output tester for class B operation of tubes.

### Essential Tube-Tester Requirements

1. The tester should provide for making a short-circuit test before measurement of the tube's characteristics.
2. It is important that some means of controlling the voltages applied to the electrodes of the tube be provided. If

the tester is ac operated, a line-voltage control permits the supply of proper electrode voltages.

3. It is essential that the rated voltage applied to the filament or heater be maintained accurately.

4. It is suggested that the characteristics test follow one of the methods described. The method selected and the quality of the parts used in the test will depend upon the user's requirements.

### Tube-Tester Limitations

A tube-testing device can only indicate the difference between a given tube's characteristics and those which are standard for that particular type. Since the operating conditions imposed upon a tube of a given type may vary within wide limits, it is impossible for a tube-testing device to evaluate tubes in terms of performance capabilities for all applications. The tube tester, therefore, cannot be looked upon as a final authority in determining whether or not a tube is always satisfactory. Actual operating test in the equipment in which the tube is to be used will give the best possible indication of a tube's worth.

# Resistance-Coupled Amplifiers

**R**ESISTANCE-COUPLED, audio-frequency voltage amplifiers utilize simple components and are capable of providing essentially uniform amplification over a relatively wide frequency range.

## Suitable Tubes

In this section, data are given for over 45 types of tubes suitable for use in resistance-coupled circuits. These types include low- and high- $\mu$  triodes, twin triodes, triode-connected pentodes, and pentodes. The accompanying key to tube types will assist in locating the appropriate data chart.

## Circuit Advantages

For most of the types shown, the data pertain to operation with cathode bias; for all of the pentodes, the data pertain to operation with series screen-grid resistor. The use of a cathode-bias resistor where feasible and a series screen-grid resistor where applicable offers several advantages over fixed-voltage operation.

The advantages are: (1) effects of possible tube differences are minimized; (2) operation over a wide range of plate-supply voltages without appreciable change in gain is feasible; (3) the low frequency at which the amplifier cuts off is easily changed; and (4) tendency toward motorboating is minimized.

## Number of Stages

These advantages can be enhanced by the addition of suitable decoupling filters in the plate supply of each stage of a multi-stage amplifier. With proper filters, three or more amplifier stages can be operated from a single power-supply unit of conventional design with-

Type	Chart No.	Type	Chart No.
3AU6	2	6CG7	8
3AV6	9	6CN7	5
3BC5/		6EU7	9
3CE5	11	6FQ7/	
3CB6	10	6CG7	8
3CF6	11	6SL7GT	5
4AU6	2	6SN7GTB	8
4BQ7A	10	6T8A	5
4BZ7	10	7AU7	3
4CB6	11	8FQ7/	
5BK7A	10	8CG7	8
5BQ7A	10	12AT6	5
5T8	5	12AT7	4
6AB4	4	12AU6	2
6AG5	11	12AU7A	3
6AT6	5	12AV6	9
6AU6A	2	12AX7A	9
6AV6	9	12AY7	1
6BC5	11	12SL7GT	5
6BK7B	10	12SN7GTA	8
6BQ7A	10	20EZ7	9
6BZ7	10	5879P	6
6C4	3	5879T	7
6CB6	11	7025	9
6CB6A	11	7199P	12
6CF6	11	7199T	13

T = Triode Unit or Triode Connection  
P = Pentode Unit or Pentode Connection

## KEY TO CHARTS



out encountering any difficulties due to coupling through the power unit. When decoupling filters are not used, not more than two stages should be operated from a single power-supply unit

### Symbols Used in Resistance-Coupled Amplifier Charts

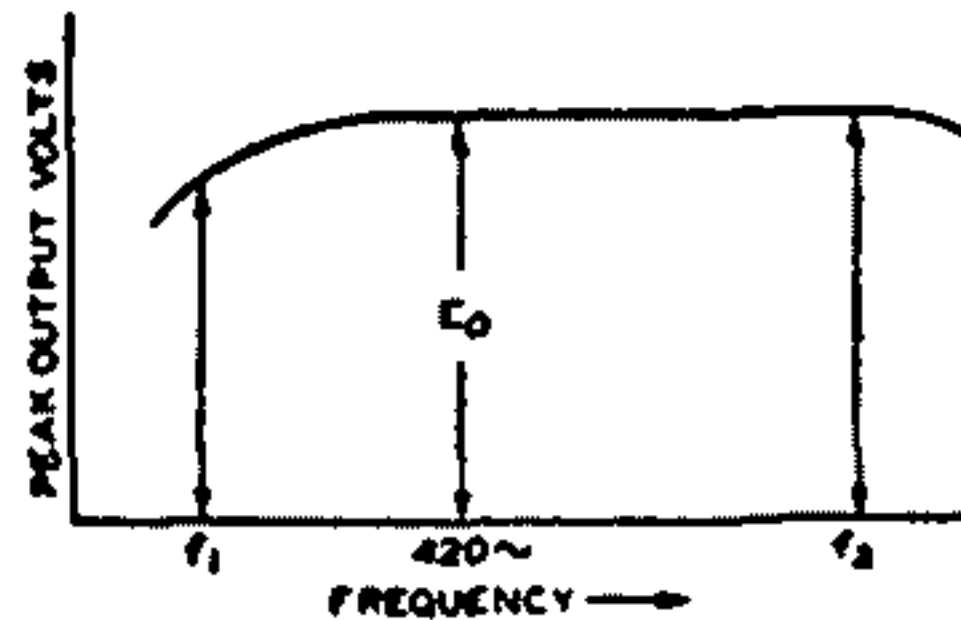
- $C$  = Blocking Capacitor ( $\mu f$ ).  
 $C_k$  = Cathode Bypass Capacitor ( $\mu f$ ).  
 $C_{sg}$  = Screen-Grid Bypass Capacitor ( $\mu f$ ).  
 $E_{bb}$  = Plate-Supply Voltage (volts).  
 Voltage at plate equals plate-supply voltage minus drop in  $R_p$  and  $R_g$ .  
 $R_k$  = Cathode Resistor (ohms).  
 $R_{sg}$  = Screen-Grid Resistor (megohms).  
 $R_r$  = Grid Resistor (megohms) for following stage.  
 $R_p$  = Plate Resistor (megohms).  
 V.G. = Voltage Gain.  
 $E_o$  = Output Voltage (peak volts).  
 This voltage is obtained across  $R_r$  (for following stage) at any frequency within the flat region of the output vs. frequency curve, and is for the condition where the signal level is adequate to swing the grid of the resistance-coupled amplifier tube to the point where its grid starts to draw current.

Note: The listed values for  $E_o$  are the peak output voltages available when the grid is driven from a low-impedance source. The listed values for the cathode resistors are optimum for any signal source. With a high-impedance source, protection against severe distortion and loss of gain due to input loading may be obtained by the use of a coupling capacitor connected directly to the input grid and a high-value resistor connected between the grid and ground.

### General Circuit Considerations

In the discussions which follow, the frequency ( $f_s$ ) is that value at which the high-frequency response begins to fall off. The frequency ( $f_1$ ) is that value at which the low-frequency response drops below a satisfactory value, as discussed below. A variation of 10 per cent in values of resistors and capacitors has only slight effect on perform-

ance. One-half-watt resistors are usually suitable for  $R_{sg}$ ,  $R_g$ ,  $R_p$ , and  $R_k$  resistors. Capacitors  $C$  and  $C_{sg}$  should have a working voltage equal to or greater than  $E_{bb}$ . Capacitor  $C_k$  may have a low working voltage in the order of 10 to 25 volts.



### Triode Amplifier Heater-Cathode Type

Capacitors  $C$  and  $C_k$  have been chosen to give an output voltage equal to  $0.8 E_o$  for a frequency ( $f_1$ ) of 100 cycles. For any other value of  $f_1$ , multiply values of  $C$  and  $C_k$  by  $100/f_1$ . In

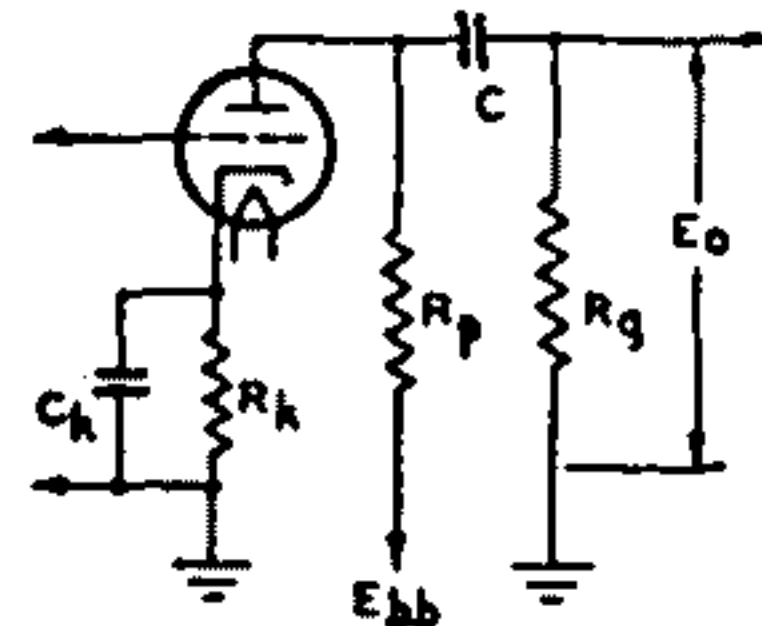


Diagram No. 1

the case of capacitor  $C_k$ , the values shown in the charts are for an amplifier with dc heater excitation; when ac is used, depending on the character of the associated circuit, the gain, and the value of  $f_1$ , it may be necessary to increase the value of  $C_k$  to minimize hum disturbances. It may be desirable to operate the heater at a positive voltage of from 15 to 40 volts with respect to the cathode. The voltage output at  $f_1$  of "n" like stages equals  $(0.8)^n \times E_o$ , where  $E_o$  is the peak output voltage of final stage. For an amplifier of typical construction, the value of  $f_s$  is well above the audio-frequency range for any value of  $R_p$ .

**Pentode Amplifier**  
*Heater-Cathode Type*

Capacitors  $C$ ,  $C_k$ , and  $C_{gs}$  have been chosen to give an output voltage equal to  $0.7 \times E_o$  for a frequency ( $f_1$ ) of 100 cycles. For any other value of  $f_1$ , multiply values of  $C$ ,  $C_k$ , and  $C_{gs}$  by  $100/f_1$ . In the case of capacitor  $C_k$ , the values shown in the charts are for

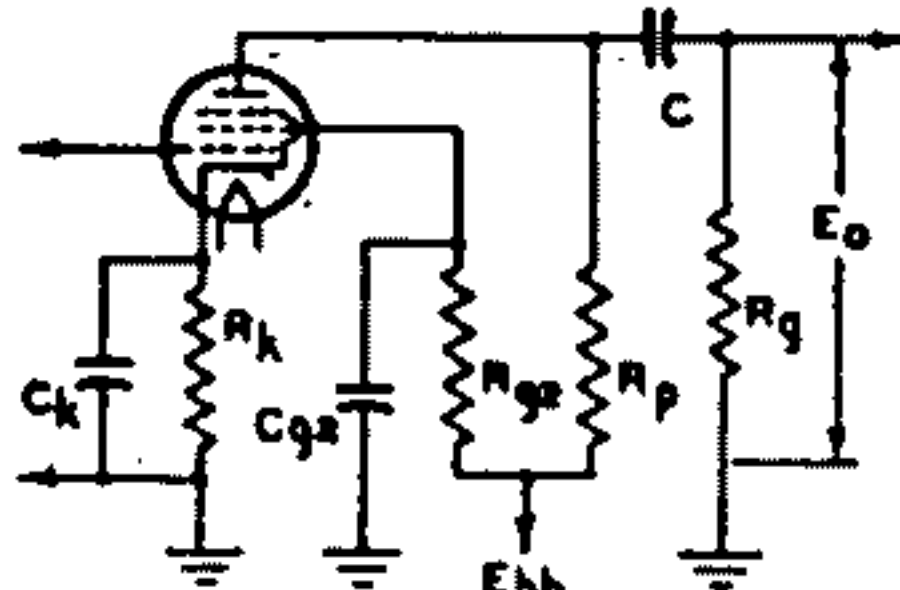


Diagram No. 2

an amplifier with dc heater excitation; when ac is used, depending on the character of the associated circuits, the voltage gain, and the value of  $f_1$ , it may be necessary to increase the value of  $C_k$  to minimize hum disturbances. It may be desirable to operate the heater at a positive voltage of from 15 to 40 volts with respect to the cathode. The voltage output at  $f_1$  for "n" like stages equals  $(0.7)^n \times E_o$  where  $E_o$  is peak output voltage of final stage. For an amplifier of typical construction, and for  $R_p$  values of 0.1, 0.25, and 0.5 megohm, approximate values of  $f_1$  are 20000, 10000, and 5000 cycles per second, respectively.

①

**12AY7\***

See Circuit Diagram 1

$E_{bb}$	$R_p$	$R_k$	$R_{gs}$	$R_g$	$C_{gs}$	$C_k$	$C$	$E_o^*$	V.G.
90	0.1	0.24	—	1800	—	—	—	13	24
	0.24	0.51	—	3700	—	—	—	14	26
	0.51	1.0	—	7800	—	—	—	16	27
100	0.1	0.24	—	1300	—	—	—	31	27
	0.24	0.51	—	2800	—	—	—	33	29
	0.51	1.0	—	5700	—	—	—	33	30
300	0.1	0.24	—	1200	—	—	—	58	28
	0.24	0.51	—	2300	—	—	—	30	30
	0.51	1.0	—	4800	—	—	—	56	31

\* One triode unit.

\* Peak volts.

^ Coupling capacitors should be selected to give desired frequency response. Cathode resistors should be adequately bypassed.

$E_{bb}$	$R_p$	$R_s$	$R_{gs}$	$R_L$	$C_{gs}$	$C_L$	$C$	$E_o^*$	V.B.
90	0.22	0.22	0.340	2700	0.057	5.8	0.0081	16	79
	0.22	0.47	0.370	2900	0.050	5.4	0.0055	22	104
	0.22	1.0	0.380	3100	0.050	5.3	0.0034	25	125
	0.47	0.47	1.00	6000	0.027	2.8	0.0042	13	105
	0.47	1.0	1.00	6200	0.023	2.7	0.0027	17	137
	0.47	2.2	1.00	6300	0.027	2.8	0.0019	25	161
	1.0	1.0	1.90	10800	0.017	1.7	0.0025	10	139
	1.0	2.2	2.40	13100	0.017	1.7	0.0017	19	184
180	0.22	0.22	0.520	1340	0.059	8.8	0.0081	31	143
	0.22	0.47	0.520	1390	0.059	8.7	0.0053	43	192
	0.22	1.0	0.520	1420	0.059	8.6	0.0032	48	223
	0.47	0.47	1.05	2700	0.039	5.5	0.0041	34	189
	0.47	1.0	1.15	2880	0.037	5.4	0.0027	43	249
	0.47	2.2	1.20	2960	0.036	5.4	0.0019	50	294
	1.0	1.0	2.40	5500	0.028	3.2	0.0023	33	230
	1.0	2.2	2.70	6000	0.022	2.8	0.0015	40	323
300	0.22	0.22	0.530	780	0.077	13.2	0.0082	53	200
	0.22	0.47	0.540	783	0.077	13.2	0.0053	65	270
	0.22	1.0	0.540	800	0.077	13.1	0.0033	74	316
	0.47	0.47	1.15	1590	0.057	8.4	0.0045	56	275
	0.47	1.0	1.22	1650	0.049	7.4	0.0027	72	357
	0.47	2.2	1.31	1720	0.045	7.2	0.0017	82	418
	1.0	1.0	2.50	3300	0.036	5.3	0.0022	57	352
	1.0	2.2	2.80	3500	0.031	4.2	0.0015	72	466

2

3AU6  
4AU6  
6AU6A  
12AU6

See Circuit Diagram 2

90	0.047	0.047	—	1600	—	3.2	0.061	9	10
	0.047	0.1	—	1800	—	2.5	0.033	11	11
	0.047	0.22	—	2000	—	2.0	0.015	14	11
	0.1	0.1	—	3000	—	1.6	0.032	10	11
	0.1	0.22	—	3800	—	1.1	0.015	15	11
	0.1	0.47	—	4500	—	1.0	0.007	18	11
	0.22	0.22	—	6800	—	0.7	0.015	14	11
	0.22	0.47	—	9500	—	0.5	0.0065	20	11
	0.22	1.0	—	11500	—	0.43	0.0035	24	11
	180	0.047	0.047	—	920	—	3.9	0.062	20
0.047		0.1	—	1200	—	2.9	0.037	26	12
0.047		0.22	—	1400	—	2.5	0.016	29	12
0.1		0.1	—	2000	—	1.9	0.032	24	12
0.1		0.22	—	2800	—	1.4	0.016	33	12
0.1		0.47	—	3600	—	1.1	0.007	40	12
0.22		0.22	—	5300	—	0.8	0.015	31	12
0.22		0.47	—	8300	—	0.56	0.007	44	12
0.22		1.0	—	10000	—	0.48	0.0035	54	12
300		0.047	0.047	—	870	—	4.1	0.065	38
	0.047	0.1	—	1200	—	3.0	0.034	52	12
	0.047	0.22	—	1500	—	2.4	0.016	68	12
	0.1	0.1	—	1900	—	1.9	0.032	44	12
	0.1	0.22	—	3000	—	1.3	0.016	68	12
	0.1	0.47	—	4000	—	1.1	0.007	80	12
	0.22	0.22	—	5300	—	0.9	0.015	57	12
	0.22	0.47	—	8800	—	0.52	0.007	82	12
	0.22	1.0	—	11000	—	0.46	0.0035	92	12

3

6C4  
7AU7\*  
9AU7\*  
12AU7A\*

See Circuit Diagram 1

\* One triode unit.

\* Peak volts.



4

6AB4  
12AT7\*

See Circuit  
Diagram 1

$E_{bb}$	$R_p$	$R_c$	$R_{c2}$	$R_k$	$C_{c2}$	$C_k$	$C$	$E_c^*$	V.R.
90	0.1	0.1	—	2680	—	2.4	0.026	8	24
	0.1	0.22	—	3060	—	2.00	0.014	11	25
	0.1	0.47	—	3390	—	1.84	0.0074	13	28
	0.22	0.22	—	5500	—	1.33	0.0136	10	25
	0.22	0.47	—	6300	—	1.01	0.0067	14	28
	0.22	1.0	—	6930	—	0.92	0.0038	15	28
	0.47	0.47	—	10900	—	0.63	0.007	13	26
	0.47	1.0	—	12500	—	0.52	0.0043	14	28
	0.47	2.2	—	13500	—	0.47	0.0031	18	28
180	0.1	0.1	—	1407	—	3.6	0.029	20	31
	0.1	0.22	—	1674	—	3.0	0.016	28	33
	0.1	0.47	—	1786	—	2.6	0.0083	31	34
	0.22	0.22	—	2890	—	1.75	0.0140	24	33
	0.22	0.47	—	3860	—	1.34	0.0077	35	33
	0.22	1.0	—	4660	—	1.14	0.0047	42	33
	0.47	0.47	—	6960	—	0.83	0.0075	31	31
	0.47	1.0	—	8450	—	0.67	0.0046	39	32
	0.47	2.2	—	9600	—	0.55	0.0032	45	32
300	0.1	0.1	—	974	—	4.0	0.028	37	34
	0.1	0.22	—	1404	—	3.1	0.015	57	34
	0.1	0.47	—	2169	—	2.5	0.0083	78	33
	0.22	0.22	—	2510	—	1.9	0.015	50	33
	0.22	0.47	—	4200	—	1.3	0.0074	78	33
	0.22	1.0	—	4950	—	1.1	0.0046	85	32
	0.47	0.47	—	5700	—	0.90	0.0076	57	33
	0.47	1.0	—	8720	—	0.62	0.0041	81	32
	0.47	2.2	—	9700	—	0.57	0.0030	88	32

5

5T8  
6AT6  
6CN7  
8CN7  
6SL7GT\*  
6T8A  
12AT6  
12SL7GT\*  
19T8

See Circuit  
Diagram 1

90	0.1	0.1	—	4200	—	2.5	0.025	5.4	22
	0.1	0.22	—	4600	—	2.2	0.014	7.5	27
	0.1	0.47	—	4800	—	2.0	0.0065	9.1	30
	0.22	0.22	—	7000	—	1.5	0.013	7.3	30
	0.22	0.47	—	7800	—	1.3	0.007	10	34
	0.22	1.0	—	8100	—	1.1	0.0035	12	37
	0.47	0.47	—	12000	—	0.83	0.006	10	36
	0.47	1.0	—	14000	—	0.7	0.0035	14	39
	0.47	2.2	—	15000	—	0.6	0.002	16	41
180	0.1	0.1	—	1900	—	3.6	0.027	19	30
	0.1	0.22	—	2200	—	3.1	0.014	25	35
	0.1	0.47	—	2500	—	2.8	0.0065	32	37
	0.22	0.22	—	3400	—	2.2	0.014	24	38
	0.22	0.47	—	4100	—	1.7	0.0065	34	42
	0.22	1.0	—	4600	—	1.5	0.0035	38	44
	0.47	0.47	—	6600	—	1.1	0.0065	29	44
	0.47	1.0	—	8100	—	0.9	0.0035	38	46
	0.47	2.2	—	9100	—	0.8	0.002	43	47
300	0.1	0.1	—	1500	—	4.4	0.027	40	34
	0.1	0.22	—	1800	—	3.6	0.014	54	38
	0.1	0.47	—	2100	—	3.0	0.0065	63	41
	0.22	0.22	—	2600	—	2.5	0.013	51	42
	0.22	0.47	—	3200	—	1.9	0.0065	65	46
	0.22	1.0	—	3700	—	1.6	0.0035	77	48
	0.47	0.47	—	5200	—	1.2	0.006	61	48
	0.47	1.0	—	6300	—	1.0	0.0035	74	50
	0.47	2.2	—	7200	—	0.9	0.002	85	51

\* One triode unit.

\* Peak volts.

$E_{bb}$	$R_p$	$R_x$	$R_{k2}$	$R_k$	$C_{k2}$	$C_k$	$C$	$E_o^*$	V.G.
90	0.1	0.1	0.35	1700	0.044	4.6	0.020	13	29
	0.1	0.22	0.35	1700	0.046	4.5	0.012	17	39
	0.1	0.47	0.35	1700	0.047	4.4	0.006	20	47
	0.22	0.22	0.80	3000	0.034	3.2	0.010	15	43
	0.22	0.47	0.80	3000	0.035	3.1	0.005	21	59
	0.22	1.0	0.80	3000	0.036	3.0	0.003	24	67
	0.47	0.47	1.9	7000	0.021	1.8	0.005	21	59
	0.47	1.0	1.9	7000	0.022	1.7	0.003	25	75
0.47	2.2	1.9	7000	0.023	1.7	0.002	28	87	
180	0.1	0.1	0.35	700	0.060	7.4	0.020	24	39
	0.1	0.22	0.35	700	0.062	7.3	0.012	28	56
	0.1	0.47	0.35	700	0.064	7.2	0.006	33	65
	0.22	0.22	0.80	1200	0.045	5.5	0.010	24	65
	0.22	0.47	0.80	1200	0.046	5.3	0.005	31	87
	0.22	1.0	0.80	1200	0.048	5.2	0.003	34	101
	0.47	0.47	1.9	2500	0.033	3.5	0.005	27	98
	0.47	1.0	1.9	2500	0.034	3.4	0.003	32	122
0.47	2.2	1.9	2500	0.035	3.3	0.002	37	140	
300	0.1	0.1	0.35	300	0.075	10.8	0.020	25	51
	0.1	0.22	0.35	300	0.077	10.6	0.012	32	68
	0.1	0.47	0.35	300	0.080	10.5	0.006	35	83
	0.22	0.22	0.80	600	0.056	7.9	0.010	28	81
	0.22	0.47	0.80	600	0.057	7.5	0.005	37	109
	0.22	1.0	0.80	600	0.058	7.4	0.003	41	123
	0.47	0.47	1.3	1200	0.044	5.3	0.005	34	125
	0.47	1.0	1.3	1200	0.046	5.2	0.003	42	152
0.47	2.2	1.3	1200	0.047	5.1	0.002	48	174	
90	0.047	0.047	—	1800	—	2.9	0.060	9	10
	0.047	0.1	—	2100	—	2.4	0.033	12	11
	0.047	0.22	—	2200	—	2.3	0.016	14	21
	0.1	0.1	—	3200	—	1.8	0.027	10	12
	0.1	0.22	—	3900	—	1.3	0.015	13	13
	0.1	0.47	—	4300	—	1.0	0.007	16	13
	0.22	0.22	—	6200	—	0.87	0.015	12	13
	0.22	0.47	—	8100	—	0.53	0.006	16	13
0.22	1.00	—	9000	—	0.49	0.003	19	14	
180	0.047	0.047	—	1200	—	3.5	0.063	21	12
	0.047	0.1	—	1600	—	2.6	0.033	29	13
	0.047	0.22	—	1800	—	2.4	0.016	35	13
	0.1	0.1	—	2200	—	1.9	0.031	26	13
	0.1	0.22	—	2900	—	1.35	0.015	33	14
	0.1	0.47	—	3400	—	1.1	0.007	40	14
	0.22	0.22	—	4500	—	0.92	0.015	28	14
	0.22	0.47	—	6400	—	0.61	0.006	39	14
0.22	1.00	—	8200	—	0.52	0.003	47	14	
300	0.047	0.047	—	1100	—	3.9	0.063	42	13
	0.047	0.1	—	1500	—	2.8	0.033	65	13
	0.047	0.22	—	1700	—	2.5	0.016	71	14
	0.1	0.1	—	2000	—	2.1	0.032	45	15
	0.1	0.22	—	3400	—	1.4	0.015	74	15
	0.1	0.47	—	3700	—	1.1	0.007	83	15
	0.1	0.22	—	4300	—	0.97	0.015	50	15
	0.22	0.47	—	7200	—	0.63	0.007	88	15
0.22	1.00	—	7400	—	0.63	0.003	94	15	

\* Peak volts

6

As Pentode:  
5879

See Circuit  
Diagram 2

7

As Triode:  
5879

See Circuit  
Diagram 1

8

6FQ7/6CG7  
6FQ7  
6SN7GTB\*  
8FQ7/8CG7  
8FQ7\*  
12SN7GTA\*

See Circuit  
Diagram 1

$E_{bb}$	$R_p$	$R_c$	$R_{ct}$	$R_k$	$C_{c2}$	$C_k$	$C$	$E_c^*$	V.S.
90	0.047	0.047	—	1870	—	3.1	0.063	14	13
	0.047	0.1	—	2230	—	2.5	0.031	18	14
	0.047	0.22	—	2500	—	2.1	0.016	20	14
	0.1	0.1	—	3370	—	1.8	0.034	15	14
	0.1	0.22	—	4100	—	1.3	0.015	20	14
	0.1	0.47	—	4800	—	1.1	0.006	23	15
	0.22	0.22	—	7000	—	0.80	0.013	16	14
	0.22	0.47	—	9100	—	0.65	0.007	22	14
	0.22	1.00	—	10500	—	0.60	0.004	25	15
100	0.047	0.047	—	1500	—	3.6	0.066	33	14
	0.047	0.1	—	1860	—	2.9	0.055	41	14
	0.047	0.22	—	2160	—	2.2	0.015	47	15
	0.1	0.1	—	2750	—	1.8	0.028	35	15
	0.1	0.22	—	3550	—	1.4	0.015	45	15
	0.1	0.47	—	4140	—	1.3	0.007	51	16
	0.22	0.22	—	5150	—	1.0	0.016	36	16
	0.22	0.47	—	7000	—	0.71	0.007	45	16
0.22	1.00	—	7800	—	0.61	0.004	51	16	
300	0.047	0.047	—	1300	—	3.6	0.061	59	14
	0.047	0.1	—	1580	—	3.0	0.032	73	15
	0.047	0.22	—	1800	—	2.5	0.015	83	16
	0.1	0.1	—	2500	—	1.9	0.031	68	16
	0.1	0.22	—	3130	—	1.4	0.014	82	16
	0.1	0.47	—	3900	—	1.2	0.0065	96	16
	0.22	0.22	—	4800	—	0.95	0.015	68	16
	0.22	0.47	—	6500	—	0.69	0.0065	85	16
	0.22	1.00	—	7800	—	0.58	0.0035	96	16

9

3AV6  
4AV6  
6AV6  
6EU7\*  
12AV6  
12AX7A\*  
20EZ7\*  
7025\*

See Circuit  
Diagram 1

90	0.1	0.1	—	4400	—	2.7	0.023	5	29
	0.1	0.22	—	4700	—	2.4	0.013	6	35
	0.1	0.47	—	4800	—	2.3	0.007	8	41
	0.22	0.22	—	7000	—	1.6	0.012	6	39
	0.22	0.47	—	7400	—	1.4	0.006	9	45
	0.22	1.0	—	7600	—	1.3	0.003	11	48
	0.47	0.47	—	12000	—	0.9	0.006	9	48
	0.47	1.0	—	13000	—	0.8	0.003	11	52
	0.47	2.2	—	14000	—	0.7	0.002	13	55
100	0.1	0.1	—	1800	—	4.0	0.025	18	40
	0.1	0.22	—	2000	—	3.5	0.013	25	47
	0.1	0.47	—	2200	—	3.1	0.006	32	52
	0.22	0.22	—	3000	—	2.4	0.012	24	53
	0.22	0.47	—	3500	—	2.1	0.006	34	59
	0.22	1.0	—	3900	—	1.8	0.003	39	63
	0.47	0.47	—	5800	—	1.3	0.006	30	62
	0.47	1.0	—	6700	—	1.1	0.003	39	66
0.47	2.2	—	7400	—	1.0	0.002	45	68	
300	0.1	0.1	—	1300	—	4.6	0.027	43	45
	0.1	0.22	—	1500	—	4.0	0.013	57	52
	0.1	0.47	—	1700	—	3.6	0.006	66	57
	0.22	0.22	—	2200	—	3.0	0.013	54	59
	0.22	0.47	—	2800	—	2.3	0.006	69	65
	0.22	1.0	—	3100	—	2.1	0.003	79	68
	0.47	0.47	—	4300	—	1.6	0.006	62	69
	0.47	1.0	—	5200	—	1.3	0.003	77	73
	0.47	2.2	—	5900	—	1.1	0.002	92	75

\* One triode unit. \* Peak volta.



$E_{bb}$	$R_p$	$R_s$	$R_{g2}$	$R_k$	$C_{g2}$	$C_k$	$C$	$E_c^*$	V.G.
90	0.047	0.047	—	1580	—	4.0	0.058	9	18
	0.047	0.10	—	1760	—	3.5	0.032	13	19
	0.047	0.22	—	1820	—	3.0	0.015	16	20
	0.1	0.1	—	2920	—	2.1	0.029	12	19
	0.1	0.22	—	3570	—	1.7	0.015	17	20
	0.1	0.47	—	4020	—	1.4	0.0075	20	20
	0.22	0.22	—	5040	—	0.98	0.0135	16	19
	0.22	0.47	—	7500	—	0.78	0.0075	21	20
	0.22	1.0	—	8800	—	0.63	0.0036	25	20
180	0.047	0.047	—	694	—	6.0	0.062	25	23
	0.047	0.1	—	817	—	4.4	0.032	32	24
	0.047	0.22	—	905	—	4.0	0.0155	35	25
	0.10	0.1	—	1596	—	2.80	0.030	30	23
	0.10	0.22	—	1630	—	2.30	0.0152	32	24
	0.10	0.47	—	1860	—	2.00	0.0073	38	24
	0.22	0.22	—	3950	—	1.24	0.0150	35	22
	0.22	0.47	—	4500	—	0.96	0.0072	41	23
	0.22	1.0	—	5530	—	0.79	0.0038	49	23
	300	0.047	0.047	—	438	—	6.70	0.062	38
0.047		0.1	—	542	—	5.50	0.032	48	27
0.047		0.22	—	644	—	4.30	0.016	57	27
0.10		0.10	—	1009	—	3.5	0.031	42	25
0.10		0.22	—	1332	—	2.5	0.015	56	26
0.10		0.47	—	1609	—	2.1	0.0074	64	25
0.22		0.22	—	2623	—	1.5	0.015	50	24
0.22		0.47	—	3900	—	1.1	0.0073	70	24
0.22		1.0	—	4920	—	0.88	0.0039	84	24
90	0.22	0.22	0.480	3800	0.046	5.5	0.0084	10	89
	0.22	0.47	0.480	3800	0.049	5.5	0.0054	16	114
	0.22	1.0	0.500	4400	0.045	5.3	0.0034	23	128
	0.47	0.47	1.04	7200	0.033	2.9	0.0044	10	111
	0.47	1.0	1.04	7700	0.033	2.8	0.0029	15	133
	0.47	2.2	1.10	8400	0.031	2.6	0.0020	18	152
	1.0	1.0	2.50	16000	0.018	1.4	0.0023	10	118
	1.0	2.2	2.50	18600	0.016	1.2	0.0017	11	139
180	0.22	0.22	0.550	1600	0.072	9.5	0.0090	30	161
	0.22	0.47	0.620	1800	0.062	8.5	0.0053	36	208
	0.22	1.0	0.650	1900	0.062	8.5	0.0034	43	239
	0.47	0.47	1.00	3400	0.059	6.0	0.0048	34	183
	0.47	1.0	1.00	3500	0.059	6.0	0.0031	41	229
	0.47	2.2	1.00	3800	0.059	5.8	0.0020	46	262
	1.0	1.0	2.60	7300	0.029	2.7	0.0022	33	227
	1.0	2.2	2.60	7400	0.029	2.7	0.0016	38	281
300	0.22	0.22	0.600	980	0.085	13.0	0.0085	51	223
	0.22	0.47	0.680	1090	0.084	12.0	0.0055	64	288
	0.22	1.0	0.700	1150	0.081	11.0	0.0033	74	334
	0.47	0.47	1.25	2000	0.064	7.9	0.0045	52	285
	0.47	1.0	1.34	2150	0.061	7.6	0.0029	67	363
	0.47	2.2	1.53	2350	0.057	7.1	0.0019	79	416
	1.0	1.0	2.60	4000	0.044	5.2	0.0023	51	334
	1.0	2.2	3.00	4700	0.038	4.3	0.0015	69	427

10

4BQ7A\*  
4BZ7\*  
5BK7A\*  
5BQ7A\*  
6BK7B\*  
6BQ7A\*  
6BZ7\*

See Circuit Diagram 1

11

3BC5/3CE5  
3CB6  
3CF6  
4CB6  
6AG5  
6BC5  
6CB6  
6CB6A  
6CF6

See Circuit Diagram 2

\* One triode unit.

\* Peak volts.

12

7199

Pentode Unit

See Circuit Diagram 2

13

7199

Triode Unit

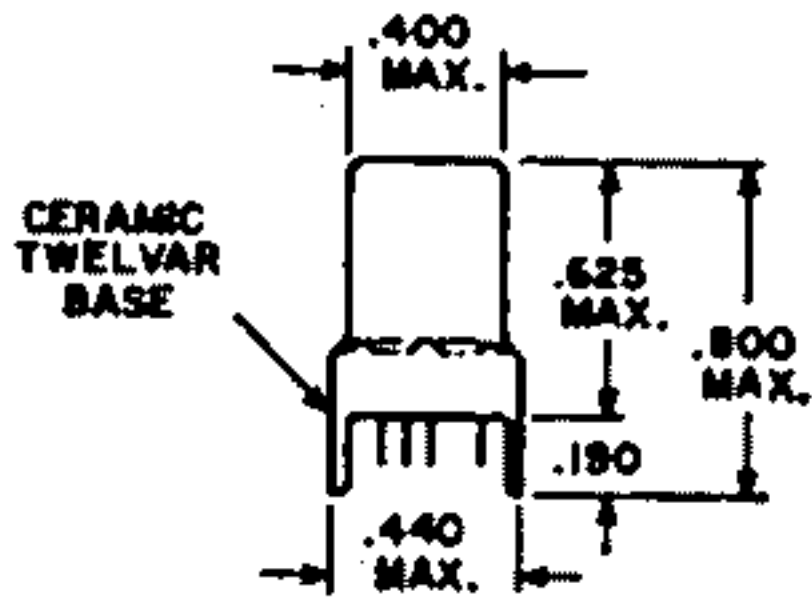
See Circuit Diagram 1

$E_{bb}$	$R_p$	$R_s$	$R_{g2}$	$R_k$	$C_{g2}$	$C_k$	$C$	$E_c^*$	V.E.
90	0.22	0.22	0.560	3700	0.046	4.50	0.0090	12	73
	0.22	0.47	0.600	3900	0.043	4.30	0.0055	17	95
	0.22	1.0	0.640	4200	0.039	4.00	0.0033	19	109
	0.47	0.47	0.870	6000	0.036	2.70	0.0046	16	95
	0.47	1.0	0.980	6700	0.044	3.00	0.0030	22	113
	0.47	2.2	1.00	6700	0.043	2.80	0.0020	25	131
	1.0	1.0	2.00	12200	0.021	1.44	0.0028	15	119
	1.0	2.2	2.20	12800	0.024	1.74	0.0016	21	167
100	0.22	0.22	0.530	1570	0.069	7.50	0.0088	32	82
	0.22	0.47	0.600	1730	0.064	7.40	0.0064	38	164
	0.22	1.0	0.650	1820	0.061	7.30	0.0034	45	190
	0.47	0.47	1.12	3200	0.053	5.30	0.0046	35	147
	0.47	1.0	1.40	3500	0.042	5.10	0.0028	40	209
	0.47	2.2	1.57	3740	0.040	5.40	0.0019	45	250
	1.0	1.0	2.50	6500	0.039	2.80	0.0024	34	179
	1.0	2.2	3.40	7500	0.026	2.30	0.0015	39	277
300	0.22	0.22	0.600	9200	0.086	11.2	0.0085	52	182
	0.22	0.47	0.670	1010	0.076	10.5	0.0052	66	236
	0.22	1.0	0.720	1100	0.076	10.0	0.0033	77	257
	0.47	0.47	1.25	1950	0.060	7.0	0.0044	41	221
	0.47	1.0	1.43	3210	0.053	6.4	0.0027	72	296
	0.47	2.2	1.45	2200	0.055	6.3	0.0019	82	345
	1.0	1.0	3.00	4100	0.040	4.2	0.0022	57	295
	1.0	2.2	3.30	4340	0.037	3.6	0.0016	74	378
90	0.047	0.047	—	1292	—	3.3	0.060	8	12
	0.047	0.1	—	1401	—	2.8	0.032	10	13
	0.047	0.22	—	1470	—	2.4	0.016	11	13
	0.10	0.1	—	2630	—	1.60	0.029	9	13
	0.10	0.22	—	3090	—	1.24	0.015	12	13
	0.10	0.47	—	3440	—	1.10	0.008	14	14
	0.22	0.22	—	6550	—	0.70	0.015	12	12
	0.22	0.47	—	8270	—	0.51	0.0077	16	12
	0.22	1.0	—	9130	—	0.44	0.0045	18	12
	100	0.047	0.047	—	723	—	4.0	0.061	16
0.047		0.1	—	836	—	3.5	0.032	20	14
0.047		0.22	—	948	—	2.9	0.016	24	15
0.10		0.1	—	1543	—	2.0	0.031	17	14
0.10		0.22	—	2002	—	1.6	0.016	24	14
0.10		0.47	—	2522	—	1.2	0.0082	30	13
0.22		0.22	—	4390	—	0.79	0.015	24	13
0.22		0.47	—	6122	—	0.57	0.0078	33	12
0.22		1.0	—	8060	—	0.47	0.0046	41	12
300		0.047	0.047	—	534	—	4.0	0.061	27
	0.047	0.1	—	726	—	3.6	0.031	38	15
	0.047	0.22	—	840	—	3.0	0.015	44	15
	0.10	0.1	—	1117	—	2.3	0.031	26	15
	0.10	0.22	—	1613	—	1.7	0.0155	41	14
	0.10	0.47	—	2043	—	1.31	0.0078	51	14
	0.22	0.22	—	3133	—	0.93	0.015	36	13
	0.22	0.47	—	4480	—	0.69	0.0079	51	13
	0.22	1.0	—	4930	—	0.56	0.0045	55	13

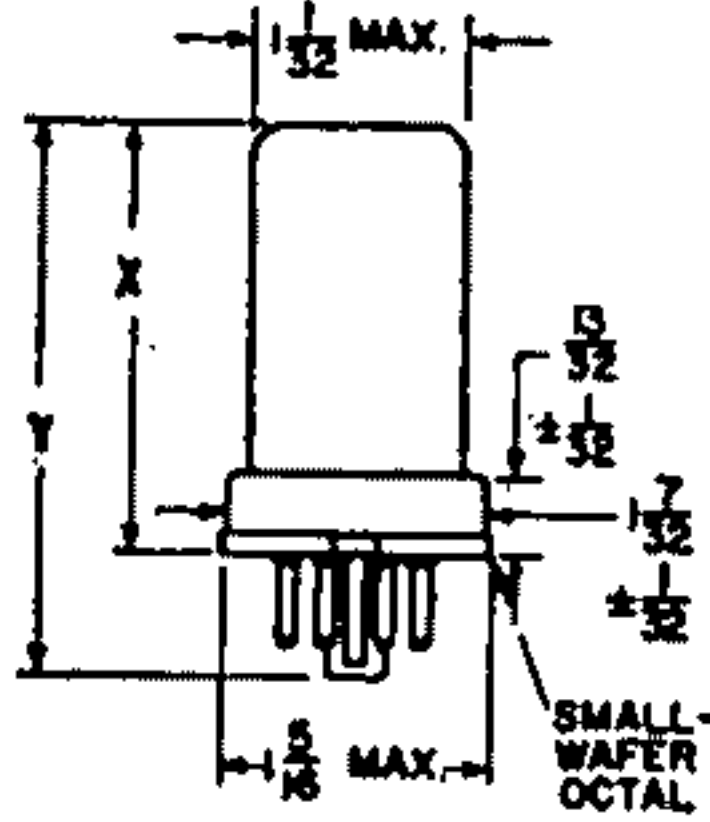
\* Peak volts.

# Outlines

## METAL TYPES

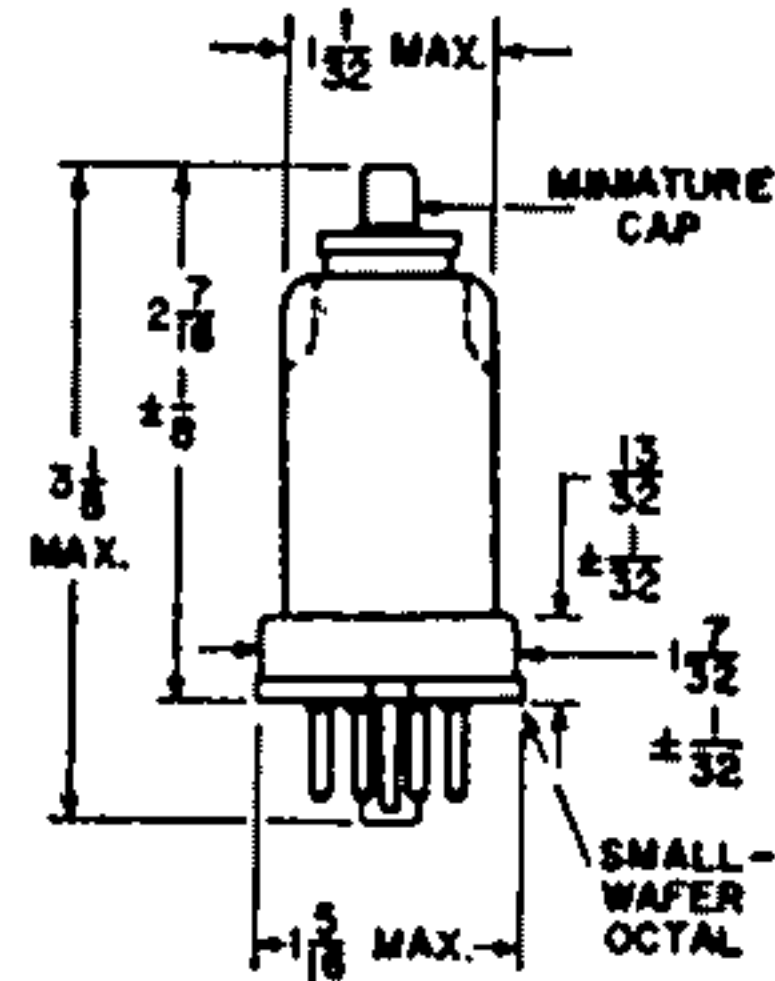


-1-

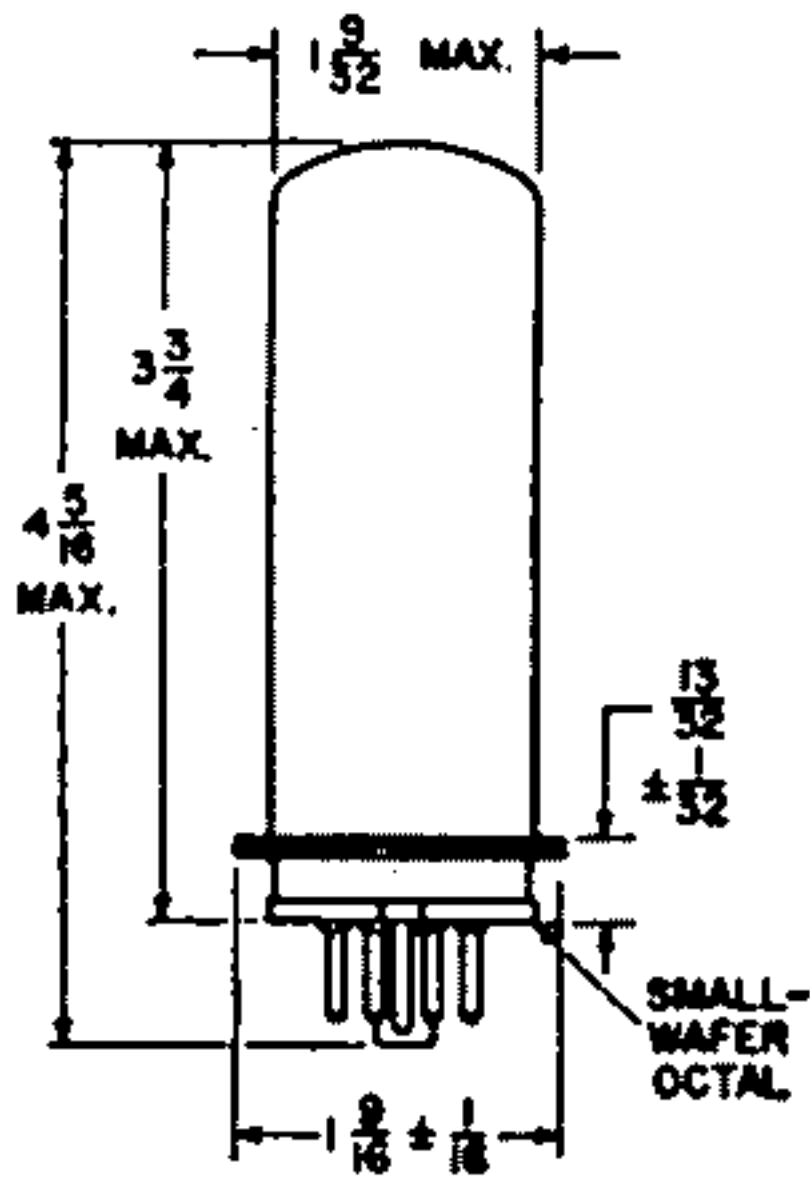


-2-

	Y	X
2A	2-5/8	2-1/16
2B	3-1/4	2-11/16

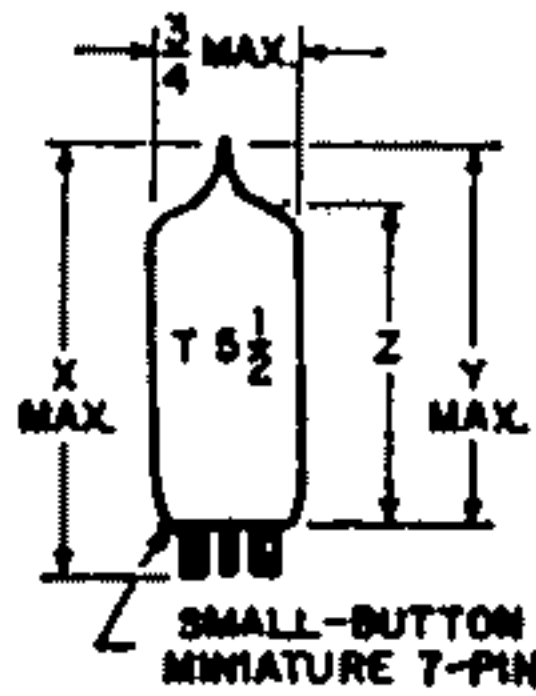


-3-



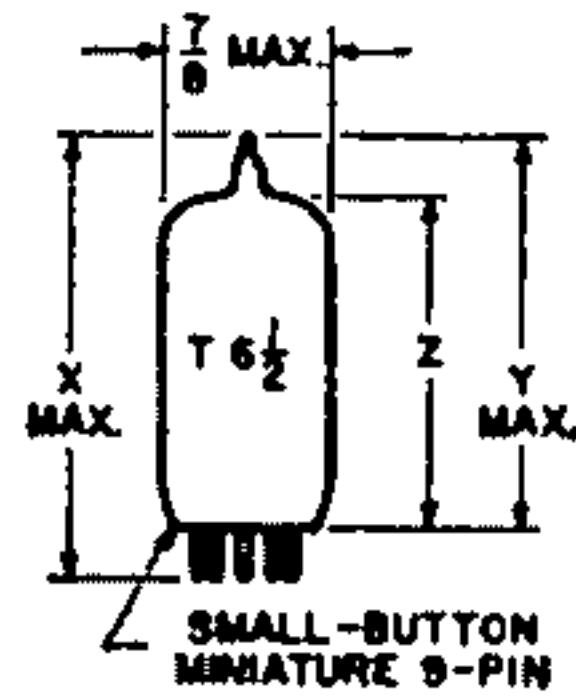
-4-

## GLASS TYPES



-5-

	X	Y	Z
5A	1-5/8	1-3/8	1 ± 3/32
5B	1-3/4	1-1/2	1-1/8 ± 3/32
5C	2-1/8	1-7/8	1-1/2 ± 3/32
5D	2-5/8	2-3/8	2 ± 3/32
5E	2-3/8	2-1/8	1-3/4 ± 3/32

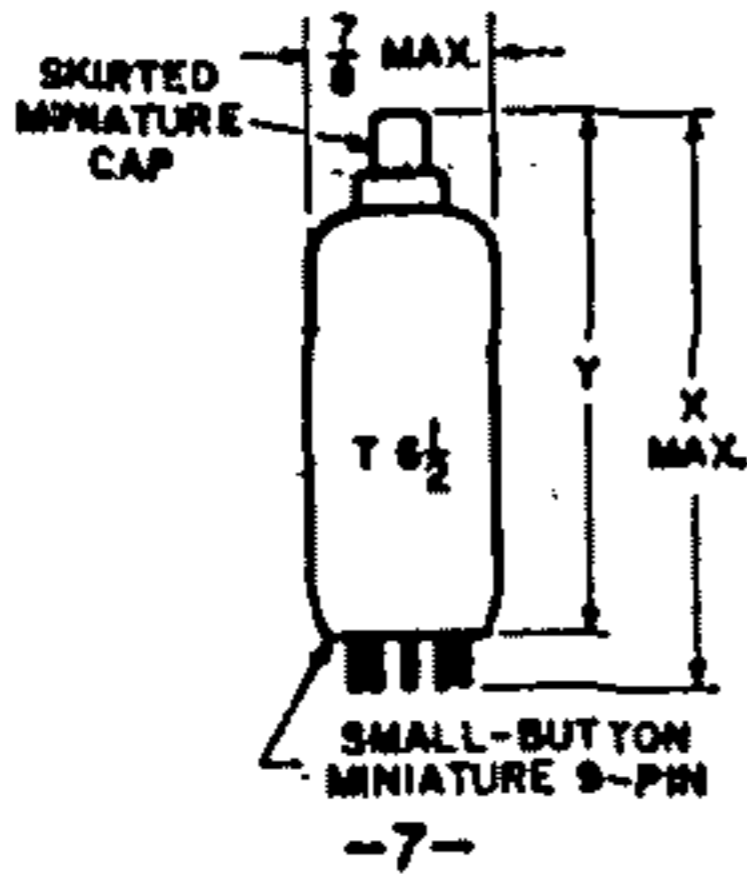


-6-

	X	Y
6A	1-3/4	1-1/2
6B	2-3/16	1-15/16
6C	2-13/32	2-5/32
6D	2-7/16	2-13/16
6E	2-5/8	2-3/8
6F	2-3/4	2-1/2
6G	3-1/16	2-13/16
6H	3-1/8	2-7/8
6J	2	1-3/4
6K	2-7/16	2-3/16

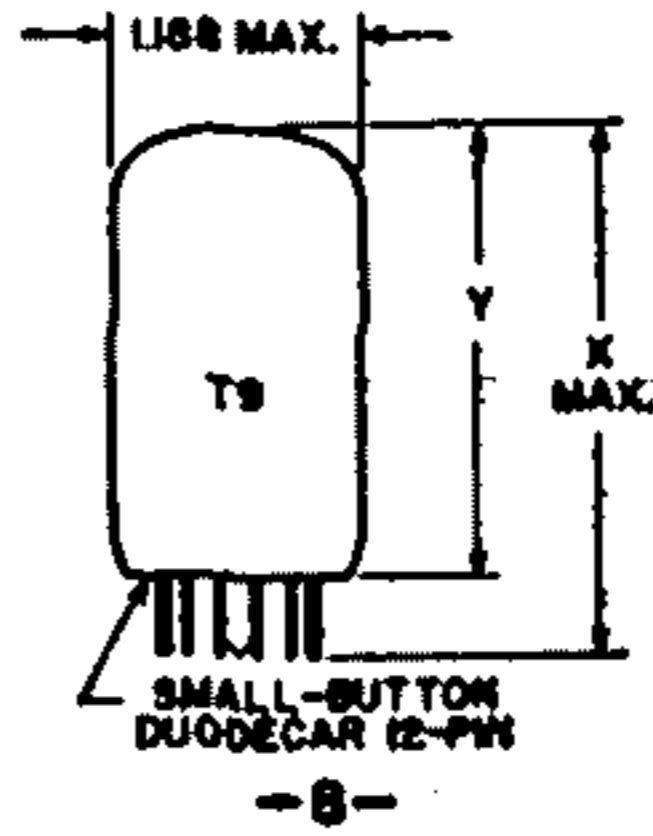
	Z
6A	1-1/8 ± 3/32
6B	1-9/16 ± 3/32
6C	1-25/32 ± 3/32
6D	1-13/16 ± 3/32
6E	2 ± 3/32
6F	2-1/8 ± 3/32
6G	2-7/16 ± 3/32
6H	2-1/2 ± 3/32
6J	-
6K	1-29/32
6L	-

All measurements in inches.



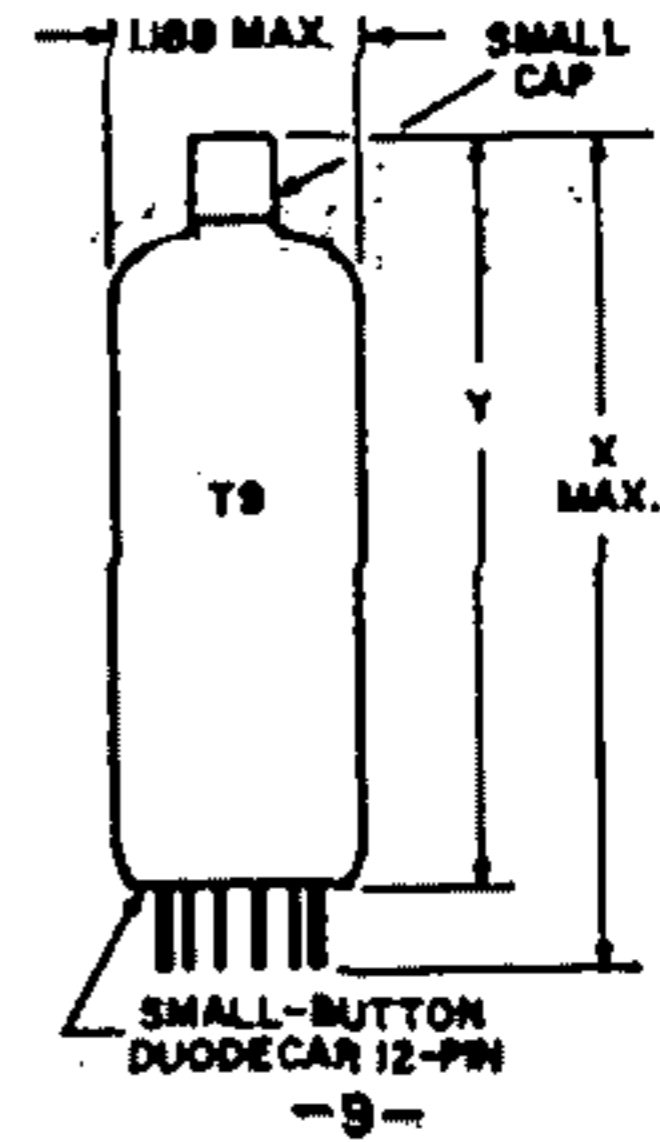
-7-

	X	Y
7A	2-27/32	2-7/16 ± 1/8
7B	3-1/16	2-15/32 MAX.
7C	3-9/32	2-7/8 ± 1/8
7D	3-1/2	3-1/4 MAX.
7E	2-17/32	2-1/8 ± 1/8
7F	2-29/32	2-5/8 MAX.



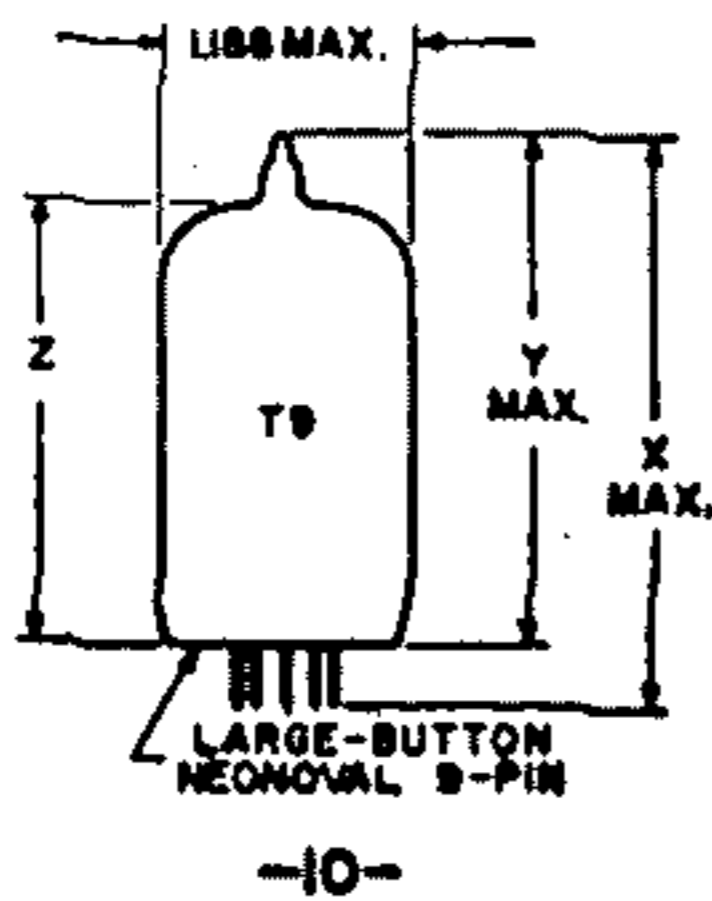
-8-

	X	Y
8A	1.875	1.250-1.500
8B	2.375	1.750-2.000
8C	2.625	2.000-2.250
8D	2.875	2.250-2.500
8E	3.050	2.770 MAX.



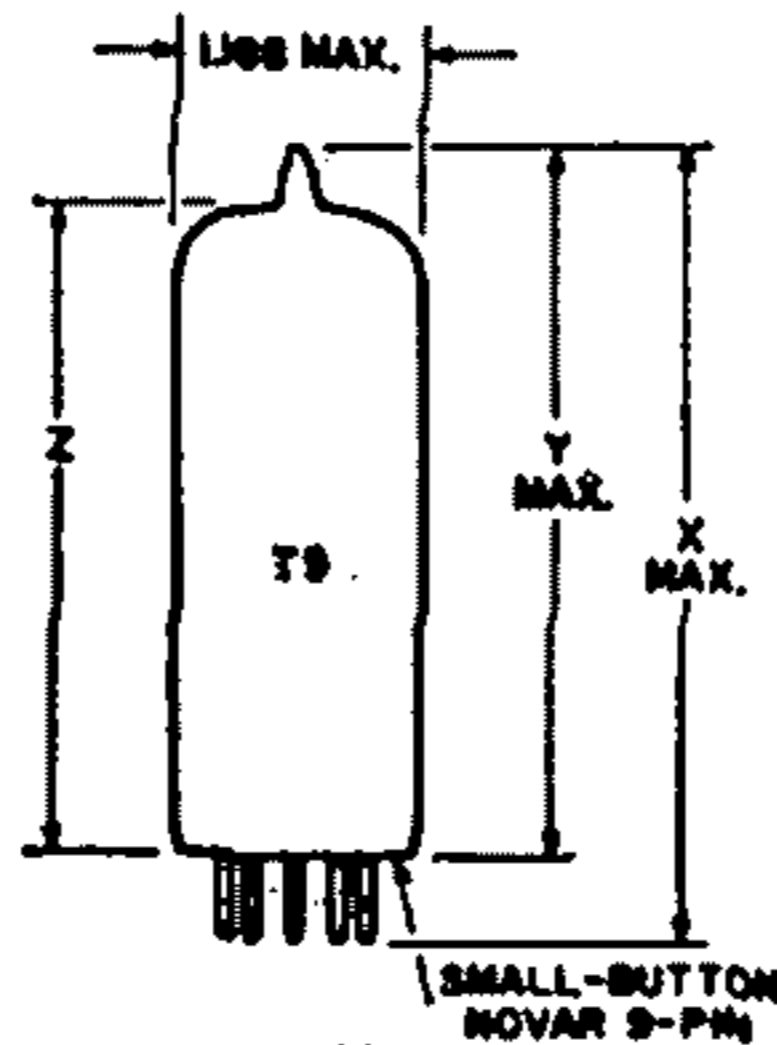
-9-

	X	Y
9A	3.375	2.750-3.000
9B	3.625	3.000-3.250
9C	4.110	3.766 MAX.



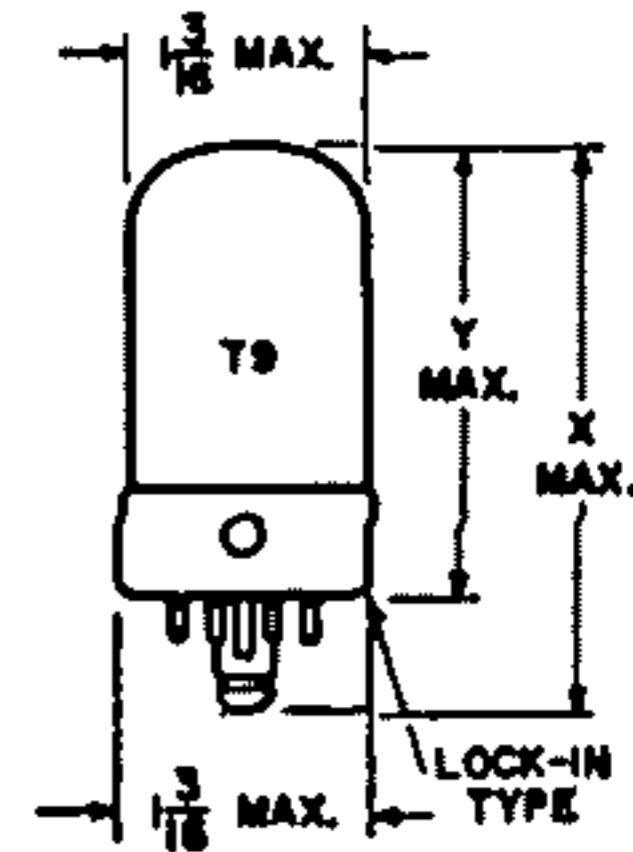
-10-

	X	Y	Z
10A	2.630	2.320	1.770-2.010
10B	2.900	2.620	2.070-2.310
10C	2.930	2.620	2.070-2.310
10D	3.230	2.920	2.370-2.610
10E	4.125	3.750	
10F	3.110	2.730	
10G	3.080	2.770	



-11-

	X	Y	Z
11A	3.000	2.620	2.100-2.200
11B	3.000	2.700	2.050-2.230
11C	3.110	2.730	2.210-2.390
11D	3.410	3.010	2.510-2.690
11E	2.960	2.580	2.060-2.240

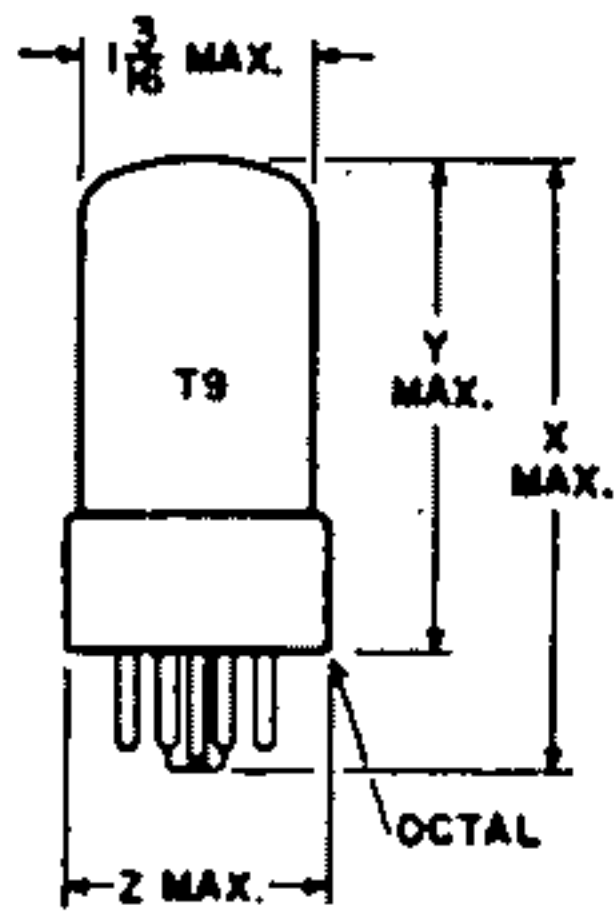


-12-

	X	Y
12A	2-9/32	1-3/4
12B	2-25/32	2-1/4
12C	3-5/32	2-5/8

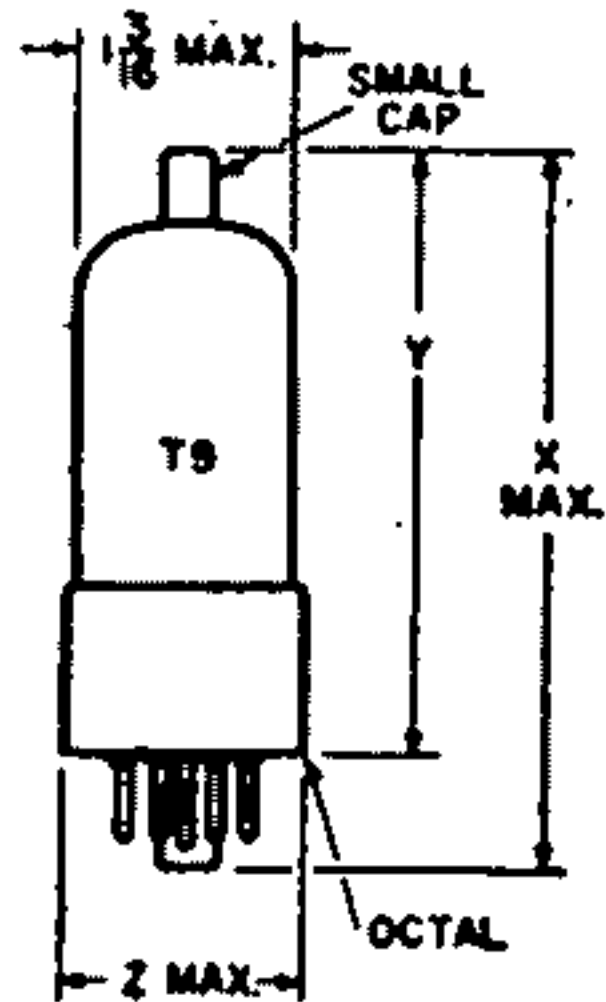
All measurements in inches.





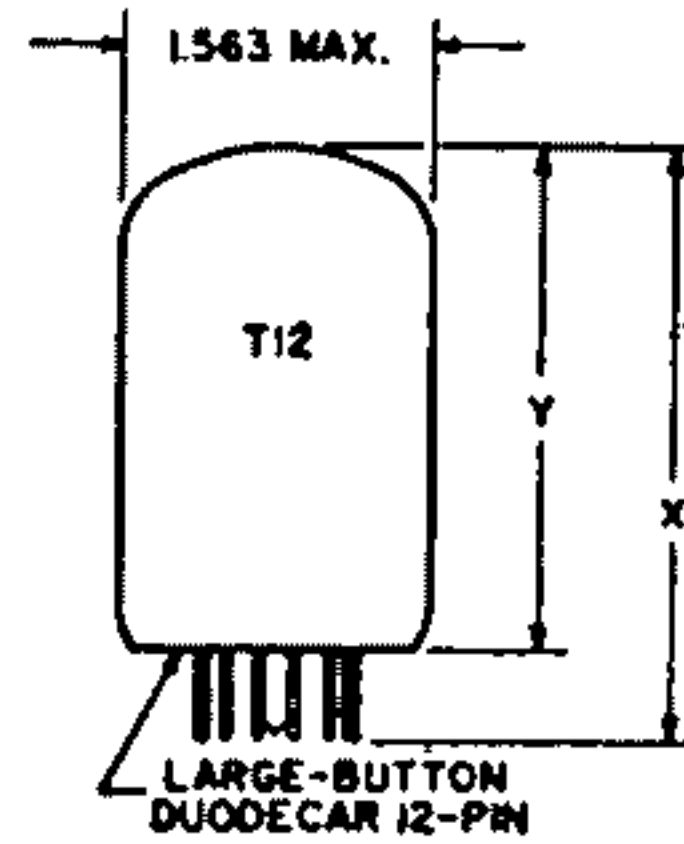
-13-

	X	Y	Z
13A	2-7/8	2-5/16	1-9/32
13B	3	2-7/16	1-9/32
13C	3-1/16	2-1/2	1-9/32
13D	3-5/16	2-3/4	1-5/16
13E	3-3/8	2-13/16	1-9/32
13F	3-7/16	2-7/8	1-9/32
13G	3-13/16	3-1/4	1-9/32
13H	4-3/16	3-9/16	1-3/16



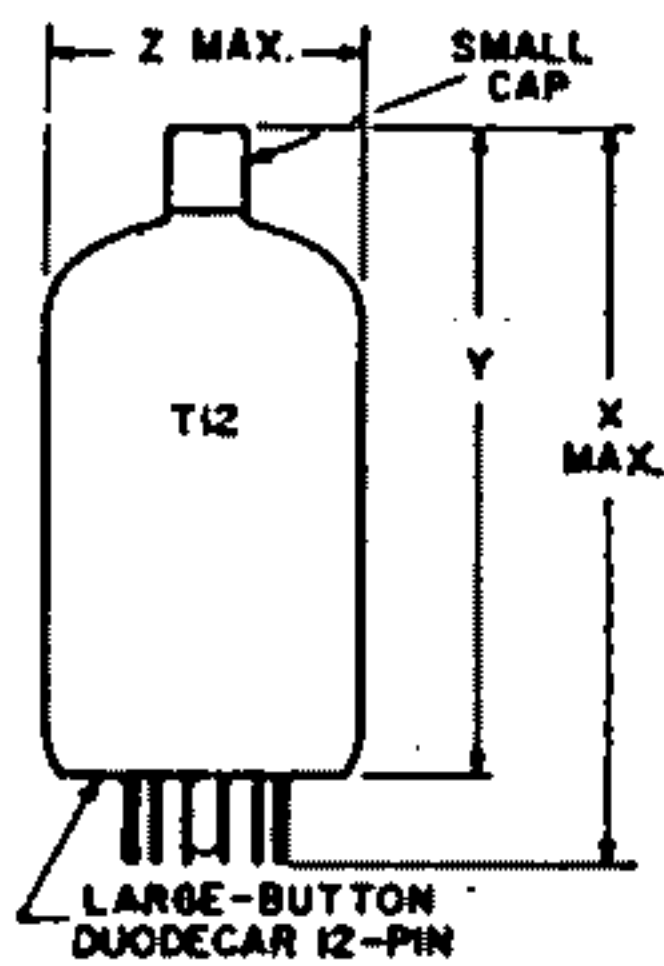
-14-

	X	Y	Z
14A	3-5/16	2-3/4	1-5/16
14B	3-9/16	3	1-9/32
14C	3-5/8	3-1/16	1-9/32
14D	3-7/8	3-5/16	1-9/32
14E	4-1/16	3-1/2	1-9/32
14F	3-13/16	3-1/4	1-9/32



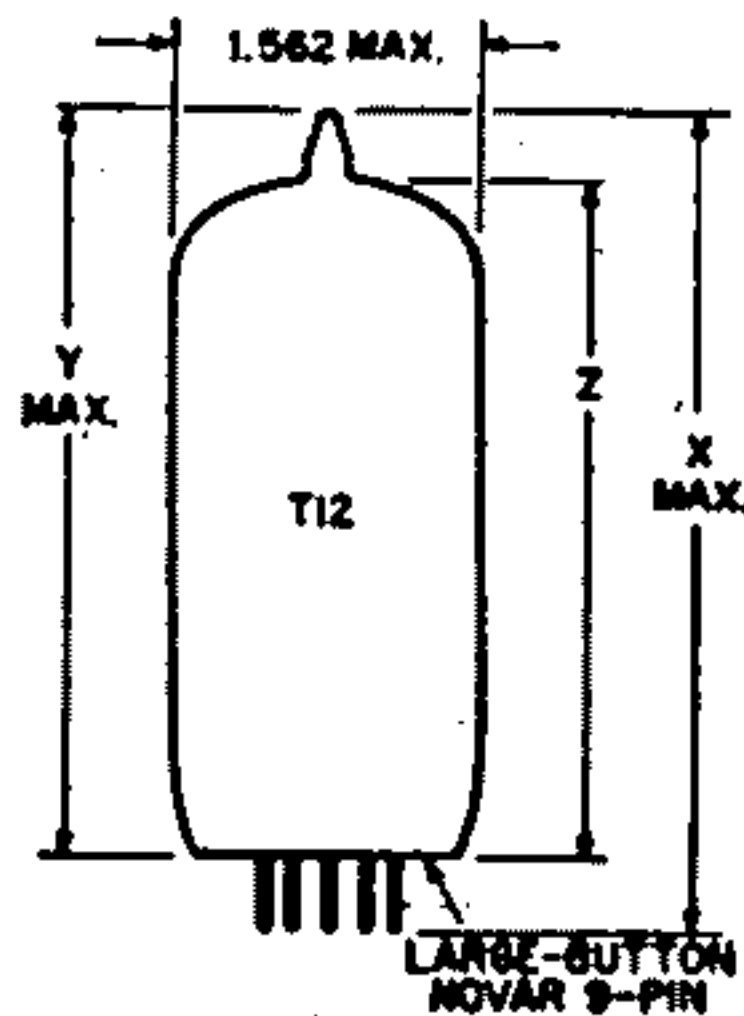
-15-

	X	Y
15A	2.875	2.250-2.500
15B	3.375	3.000 MAX.
15C	3.625	3.000-3.250
15D	3.125	2.750



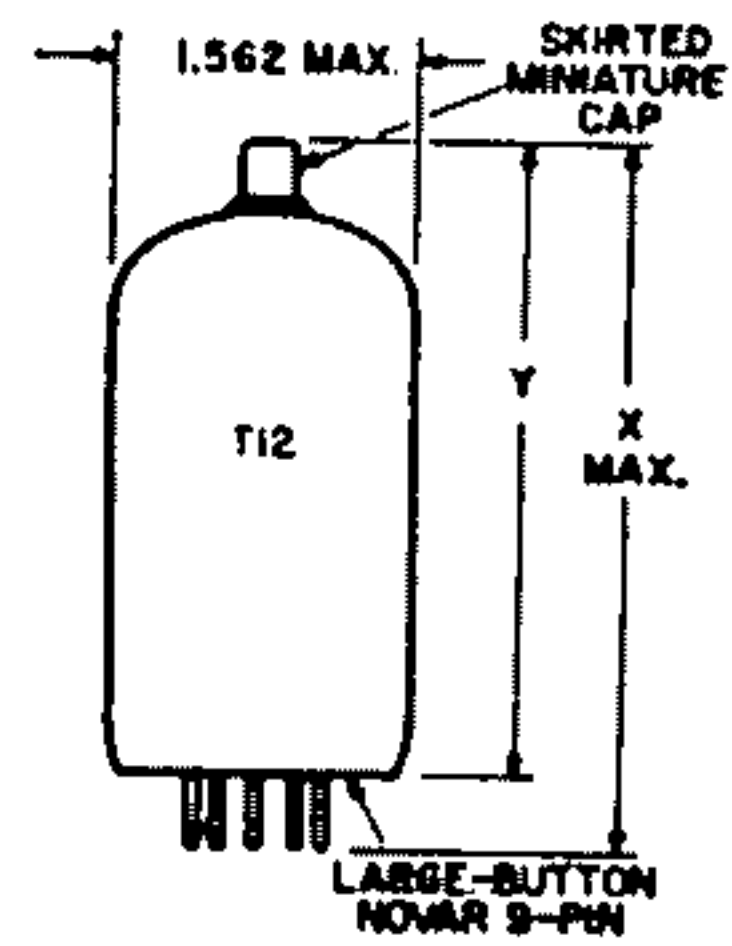
-16-

	X	Y	Z
16A	3.625	3.000-3.250	1.563
16B	4.125	3.500-3.750	1.563
16C	4.875	4.250-4.500	1.563
16D	4.375	4.000 MIN.	1.563



-17-

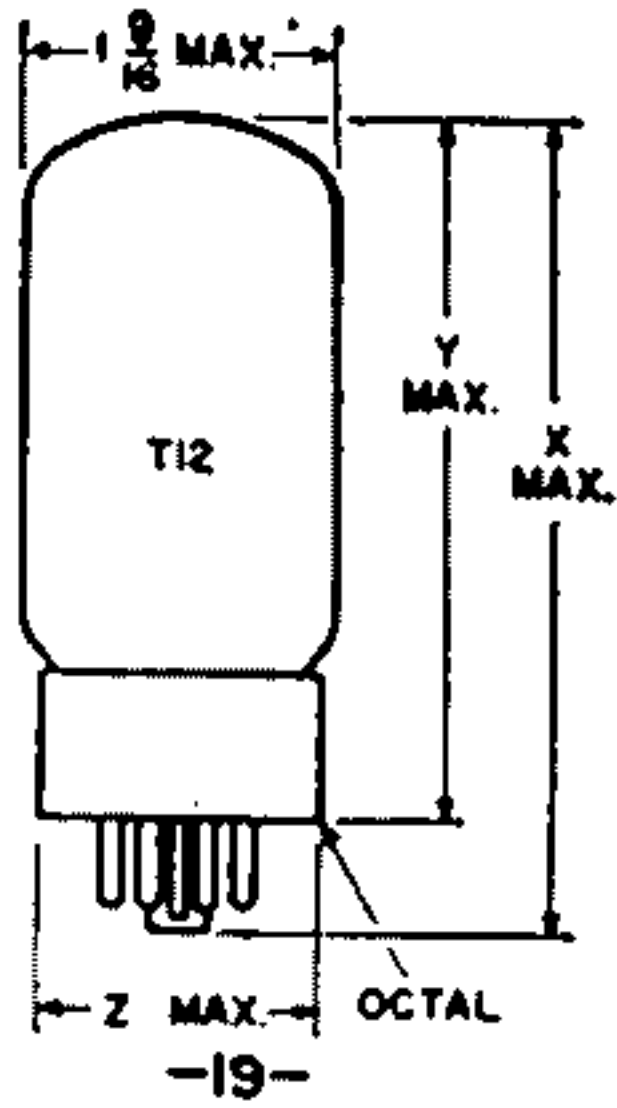
	X	Y	Z
17A	3.180	2.800	2.280-2.460
17B	3.410	3.030	2.510-2.690
17C	4.160	3.780	3.260-3.440
17D	3.550	3.170	
17E	3.710	3.330	2.810-2.900



-18-

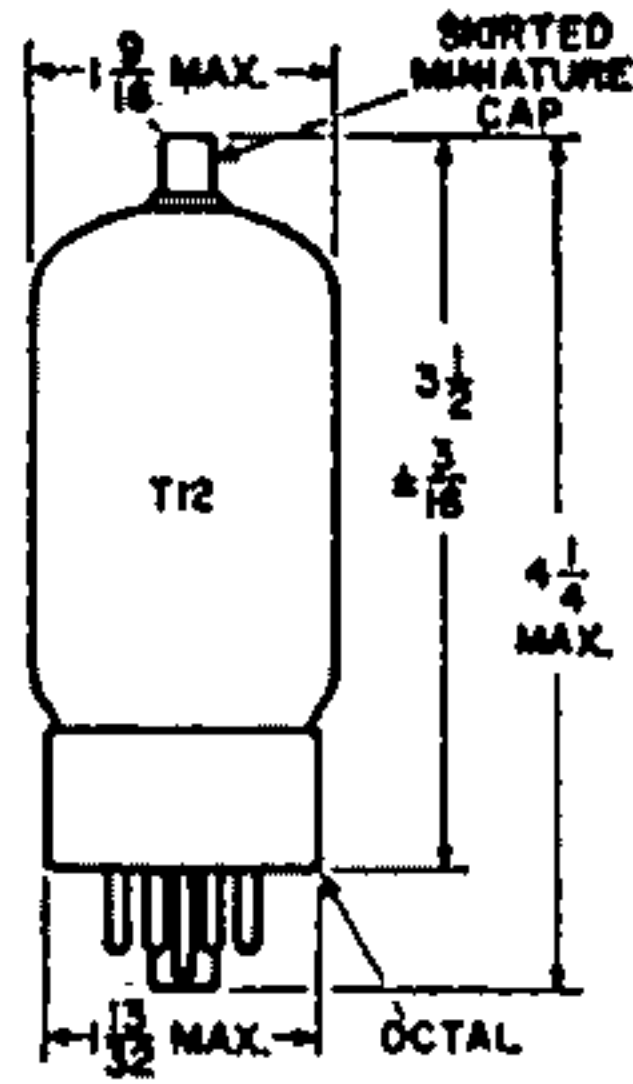
	X	Y
18A	3.55	3.04 ± 0.13
18B	4.60	4.09 ± 0.13

All measurements in inches.

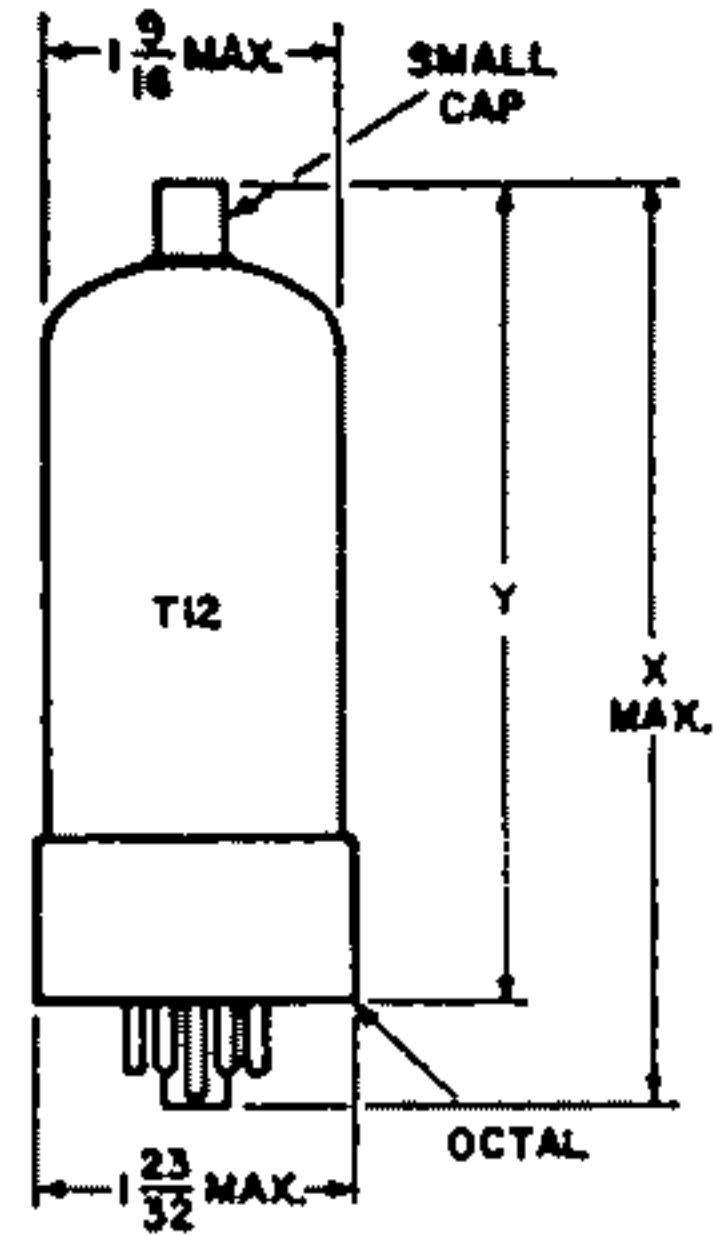


-19-

	X	Y	Z
19A	3-9/16	3	1-9/32
19B	3-7/8	3.5/16	1-13/32
19C	4	3-7/16	1-13/32
19D	4-1/4	3-11/16	1-3/8
19E	4-5/8	4-1/16	1-3/8
19F	4-5/8	4-1/16	1-5/8
19G	4-3/4	4-3/16	1-11/16
19H	5-3/16	4-5/8	1-3/8

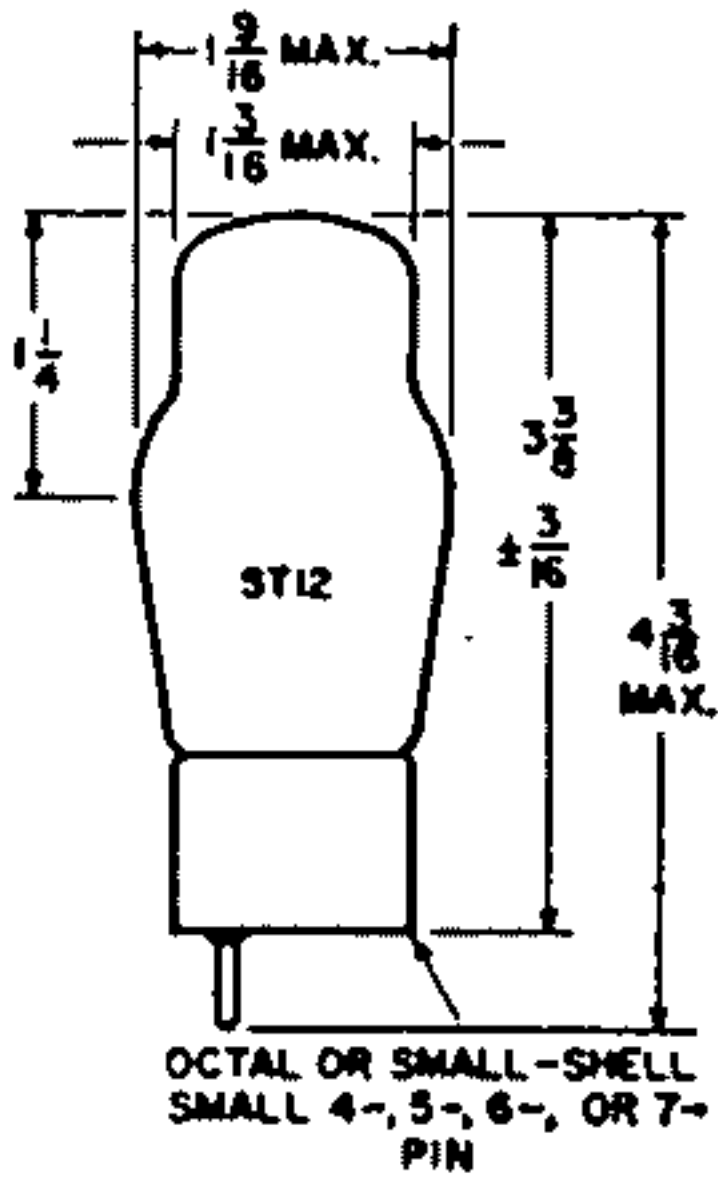


-20-

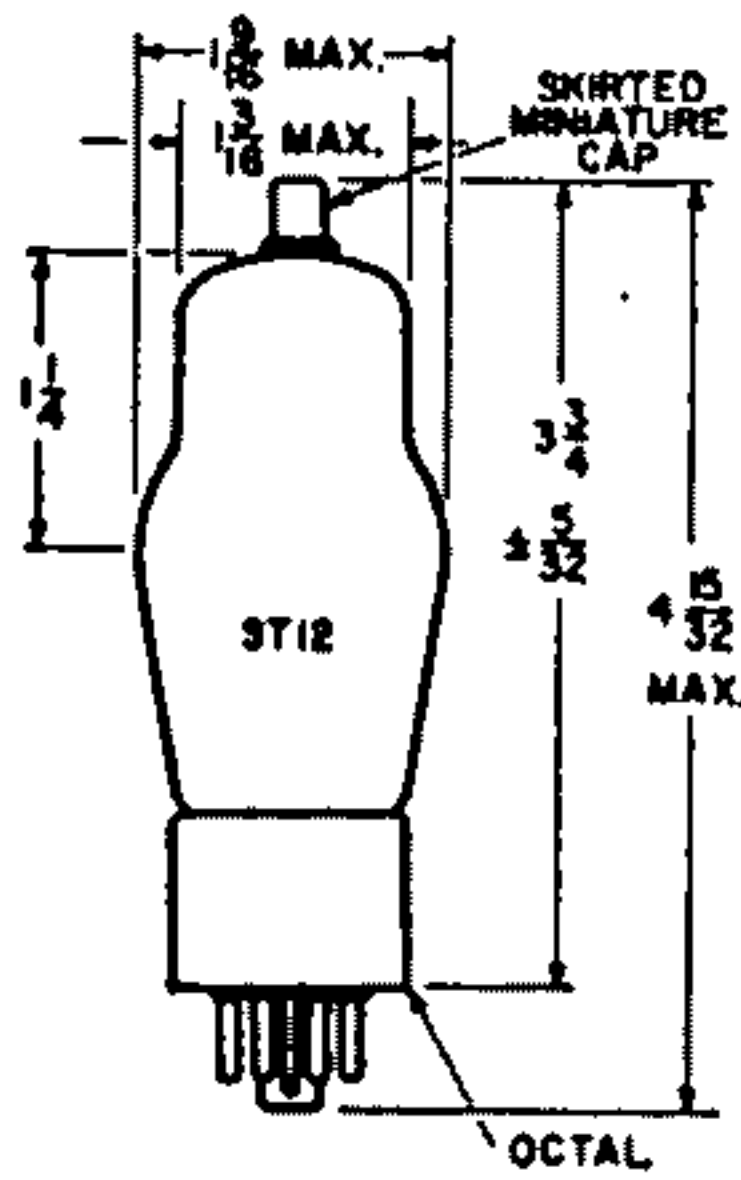


-21-

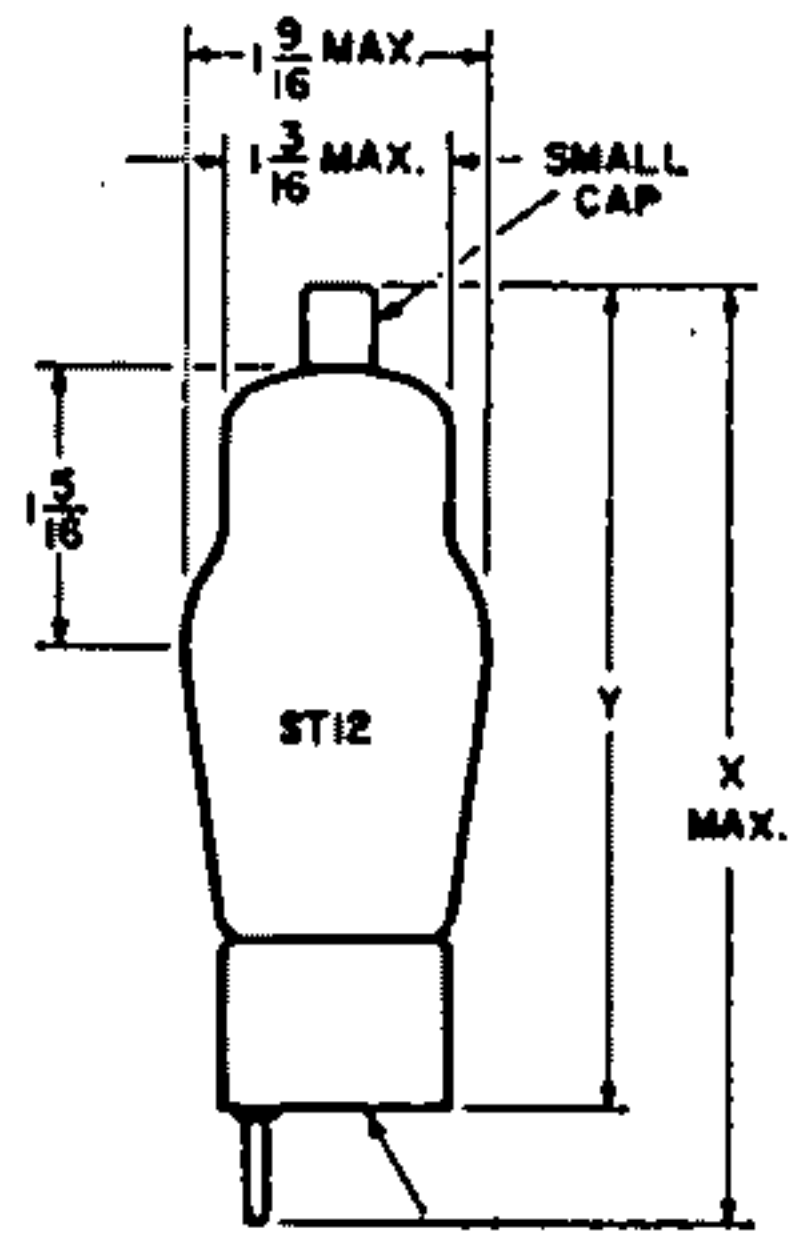
	X	Y
21A	4-3/4	4 ± 3/16
21B	5	4-7/16
21C	5-7/32	4-1/4



-22-



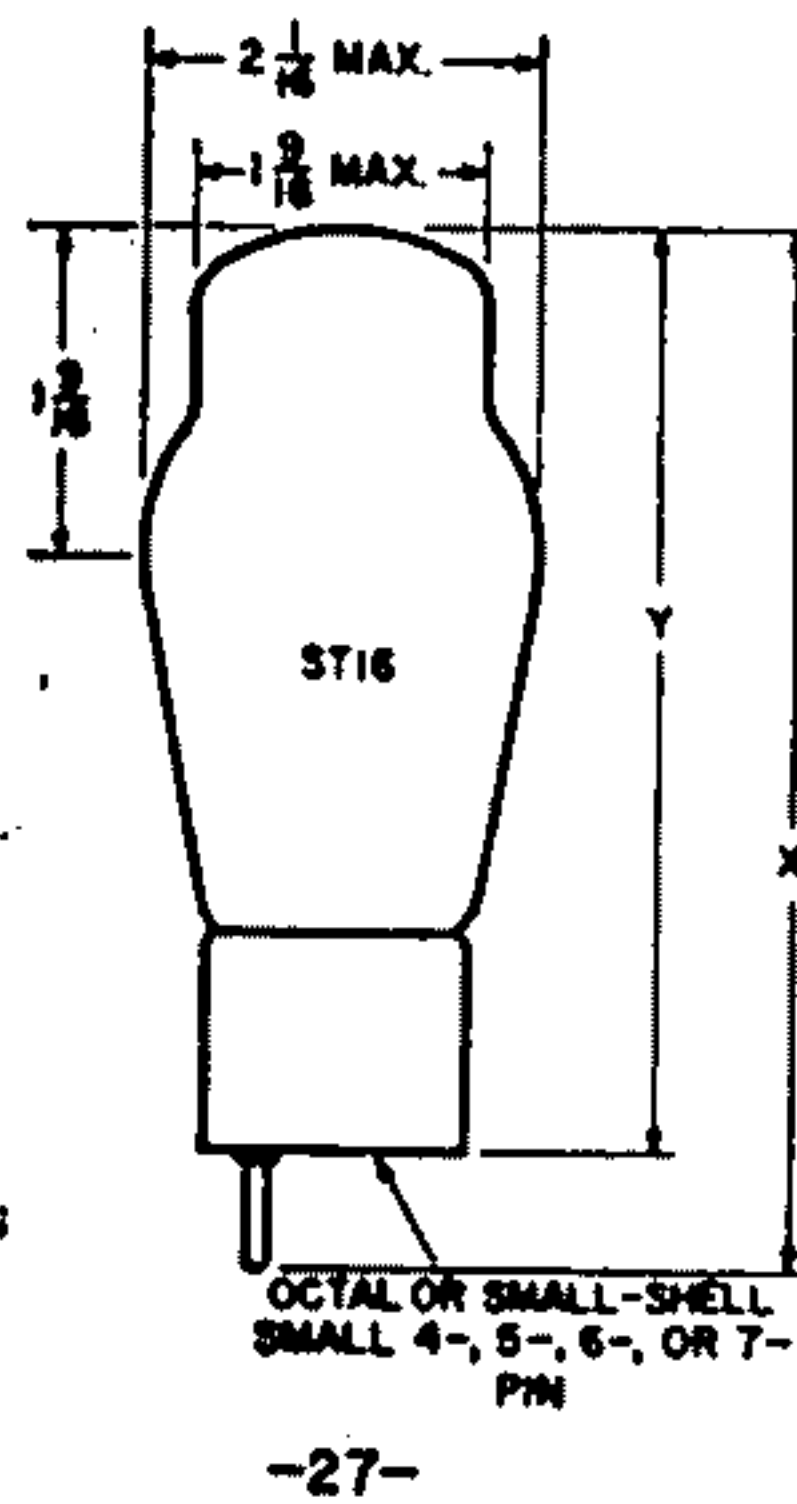
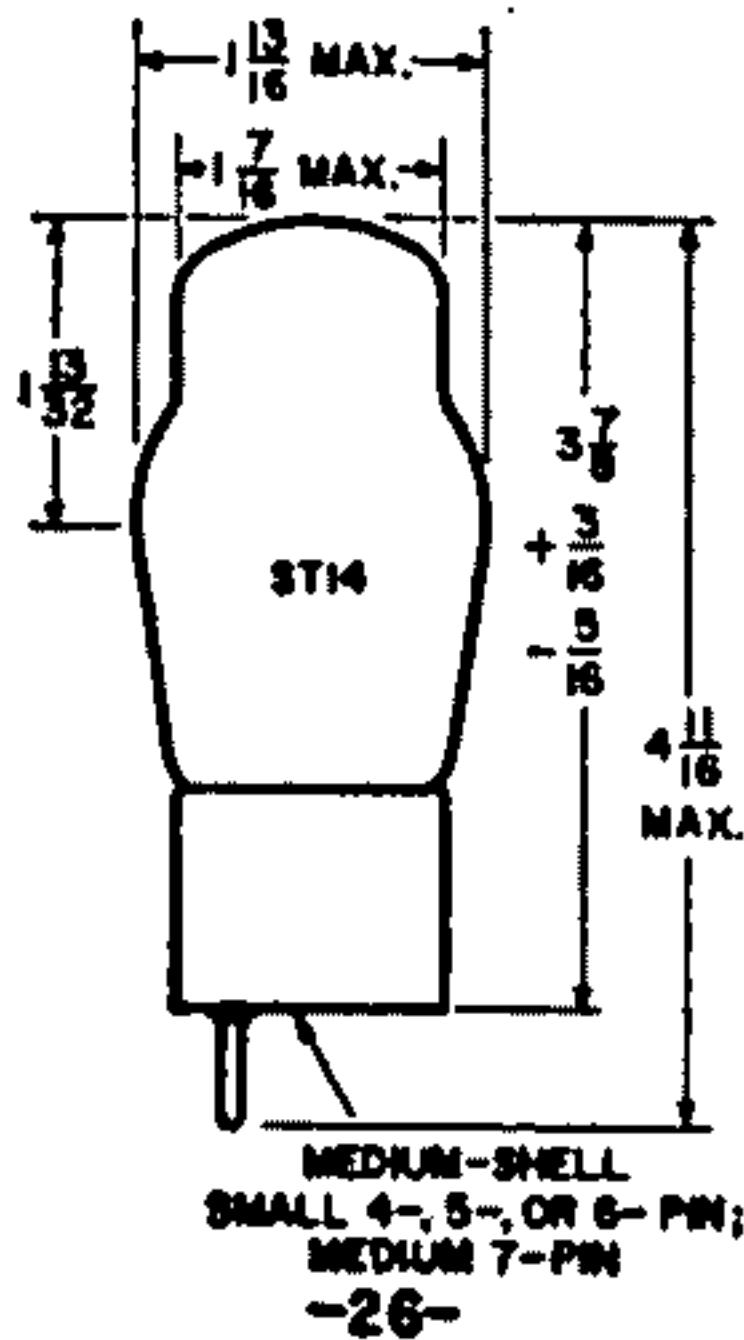
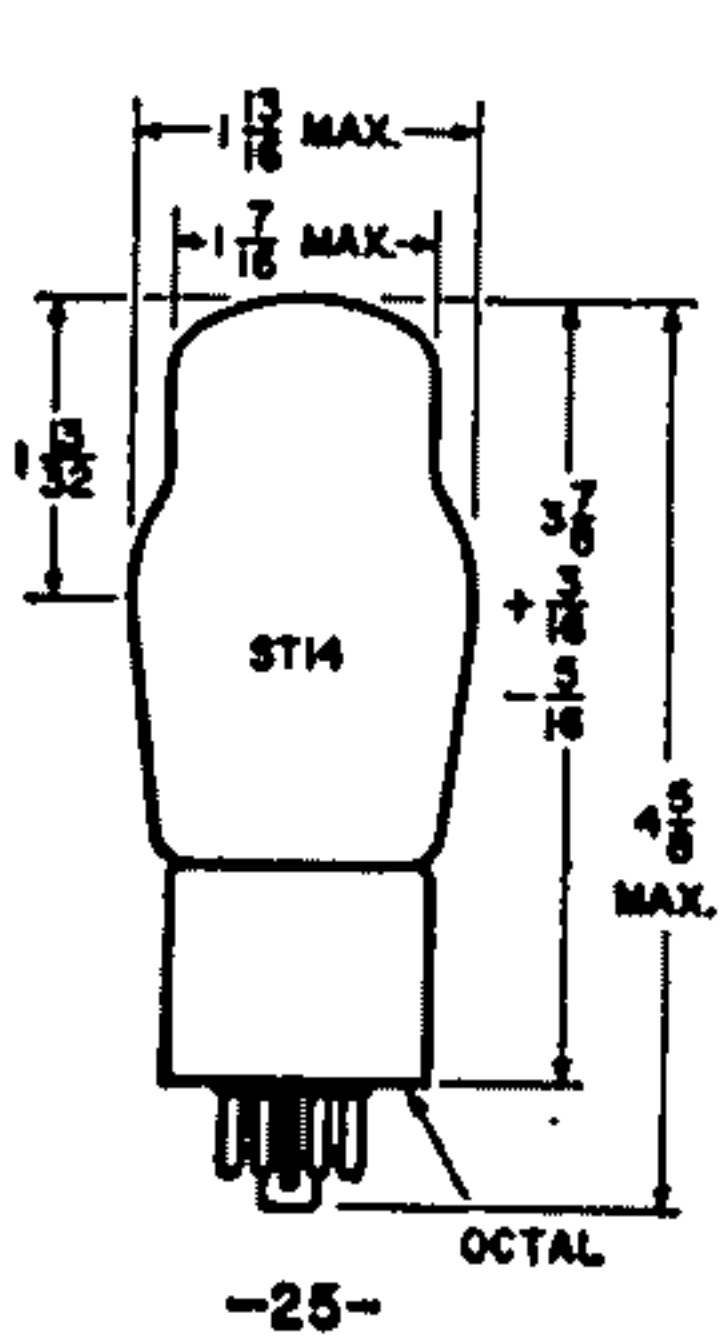
-23-



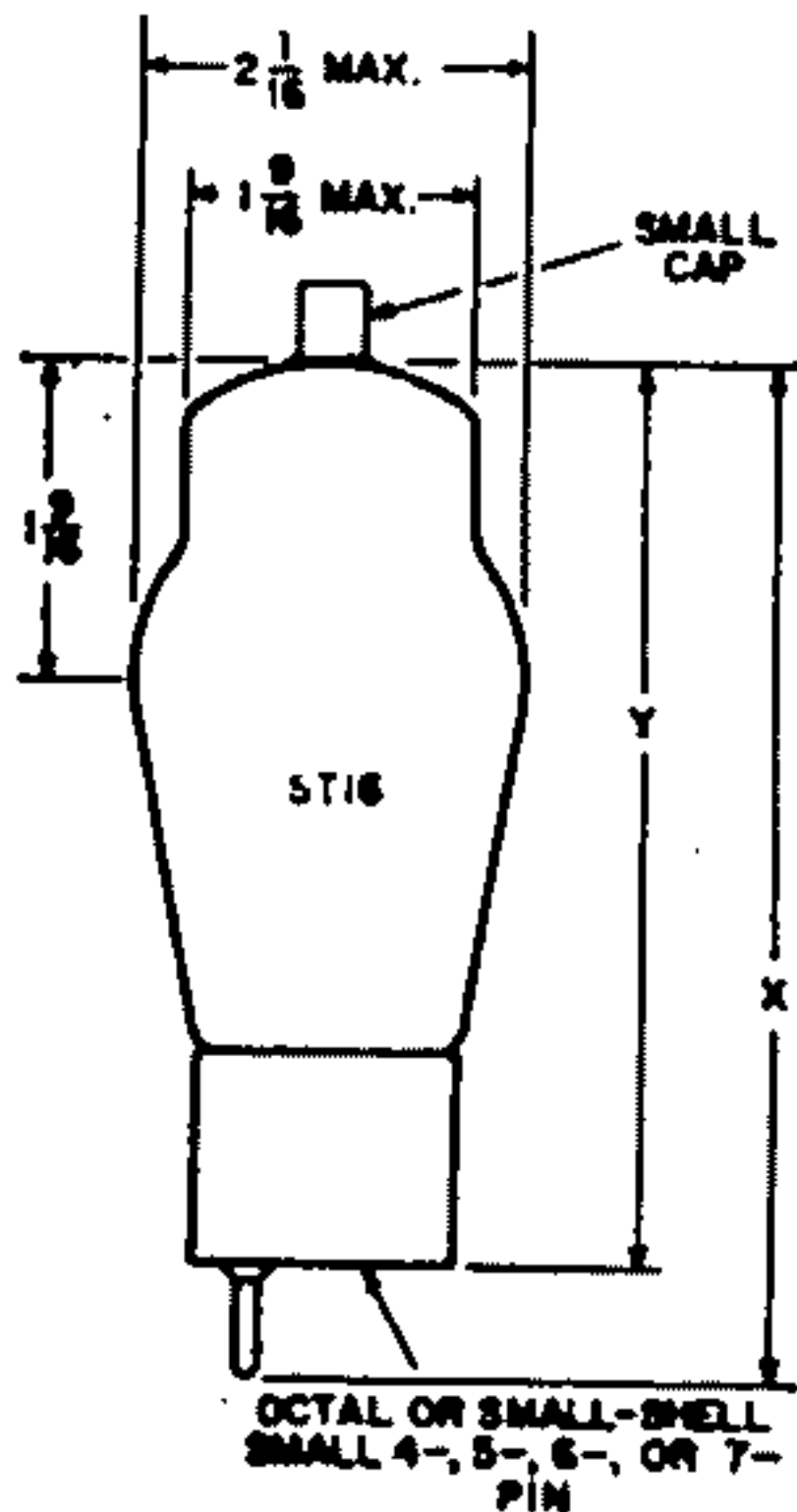
-24-

	X	Y
24A	4-15/16	4-3/16 ± 1/8
24B	4-17/32	3-25/32 ± 1/8

All measurements in inches.



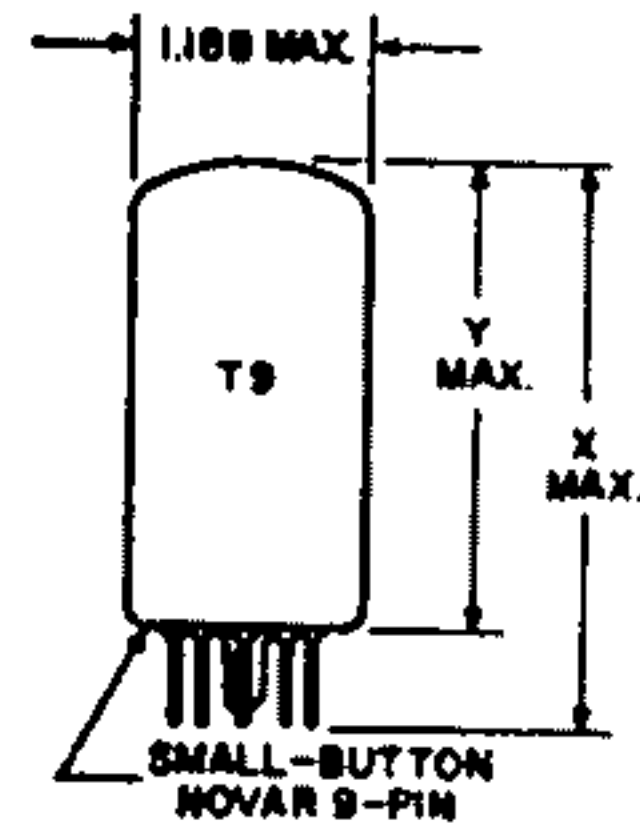
	X	Y
27A	5-1/8	4-3/8 ± 3/16
27B	5-3/8	4-9/16 ± 3/16



	X	Y
28A	5-1/8	4-7/16 ± 5/32
28B	5-11/16	4-31/32 ± 5/32

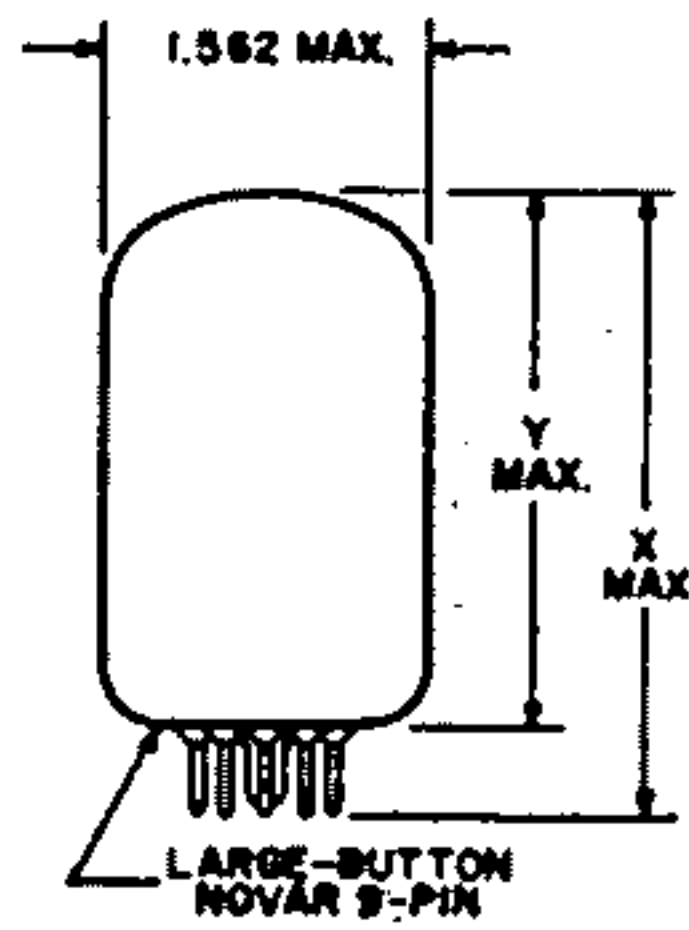
	MAX. LENGTH	MAX. DIAMETER
29A	1-3/4	0.4
29B	1-3/4	1-5/16
29C	2-5/16	1-5/16
29D	2-5/8	1-1/16
29E	2-7/8	1-5/16
29F	3	1-5/16
29G	3-7/16	1-15/16
29H	4	1-3/16
29J	4-7/8	1-9/16
29K	5-1/32	1-13/16
29L	6-1/4	2-7/16
29M	3-15/32	1-7/16

-29-



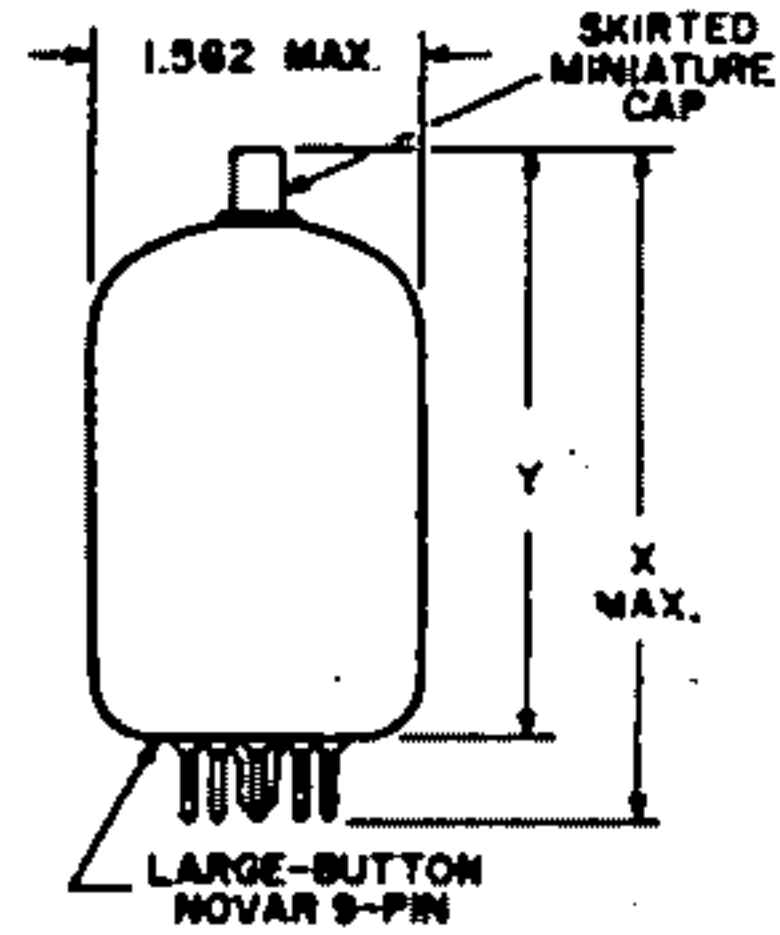
	X	Y
30A	2.380	2.000
30B	3.005	2.625
30C	3.080	2.700
30D	3.110	2.730
30E	2.125	1.750

All measurements in inches.



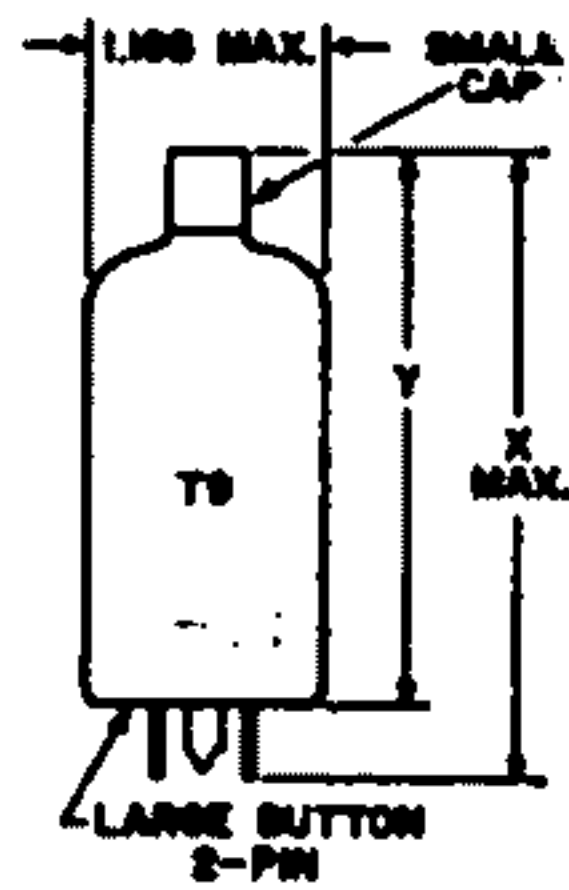
-31-

	X	Y
31A	2.880	2.500
31B	3.130	2.750
31C	3.880	3.500



-32-

	X	Y
32	3.505	2.875-3.125
32A	4.130	3.500-3.750



-33-

	X	Y
33A	3.06 Max	2.52-2.68

All measurements in inches.



# Circuits

**T**HE circuits included in this Manual illustrate some of the more important applications of RCA receiving tubes; they are not necessarily examples of commercial practice. These circuits have been conservatively designed and are capable of excellent performance. The brief description provided with each circuit explains the functional relationships of the various stages and points out intended applications, major performance characteristics, and significant design features of the over-all circuit. Detailed descriptive information on individual circuit stages (for example, amplifiers, detectors, or oscillators) is given in the section on *Electron-Tube Applications* earlier in this Manual, as well as in many textbooks on electron-tube circuits.

Electrical specifications are given for circuit components to assist those interested in home construction. Layouts and mechanical details are omitted because they vary widely with the requirements of individual set builders and with the sizes and shapes of the components employed.

Circuits designed for operation from both ac and dc voltage supplies should be installed in non-metallic cabinets or properly insulated from metallic cabinets. Potentiometer shafts and switches should make use of insulated (plastic) knobs. In practical use, no metallic part of an "ac/dc" chassis should be exposed to touch, accidental or otherwise. When such circuits are tested outside of their cabinets, a line isolation transformer such as the RCA WP-25A Isotap should be used.

Performance of these circuits depends as much on the quality of the components selected and the care employed in layout and construction as on the circuits themselves. Good signal reproduction from receivers and amplifiers requires the use of good-quality speakers, transformers, chokes, and input sources (microphones, phonograph pickups, etc.).

Coils for the receiver circuits may be purchased at local parts dealers by specifying the characteristics required: for rf coils, the circuit position (antenna or interstage), tuning range desired, and tuning capacitances employed; for if coils or transformers, the intermediate frequency, circuit position (1st if, 2nd if, etc.), and, in some cases, the associated tube types; for oscillator coils, the receiver tuning range, the intermediate frequency, the type of converter tube, and the type of winding used (tapped or transformer-coupled).

The voltage ratings specified for capacitors are the minimum dc working voltages required. Paper, mica, or ceramic capacitors having higher voltage ratings than those specified may be used except insofar as the physical sizes of such capacitors may affect equipment layout. However, if electrolytic capacitors having substantially higher voltage ratings than those specified are used, they may not "form" completely at the operating voltage, with the result that the effective capacitances of such units may be below their rated value. The wattage ratings specified for resistors assume methods of construction that provide adequate ventilation; com-

pact installations having poor ventilation may require resistors of higher wattage ratings.

Circuits which work at very high frequencies or which are required to handle very wide bandwidths demand more than ordinary skill and experience in construction. Placement of component parts is quite critical and may require considerable experimentation. All rf leads to components including bypass capacitors must be kept short and must be prop-

erly dressed to minimize undesirable coupling and capacitance effects. Correct circuit alignment and oscillator tracking may require the use of a cathode-ray oscilloscope, a high-impedance vacuum-tube voltmeter, and a signal generator capable of supplying a properly modulated signal at the appropriate frequencies. Unless the builder has had considerable experience with broad-band, high-frequency circuits, he should not undertake the construction of such circuits.

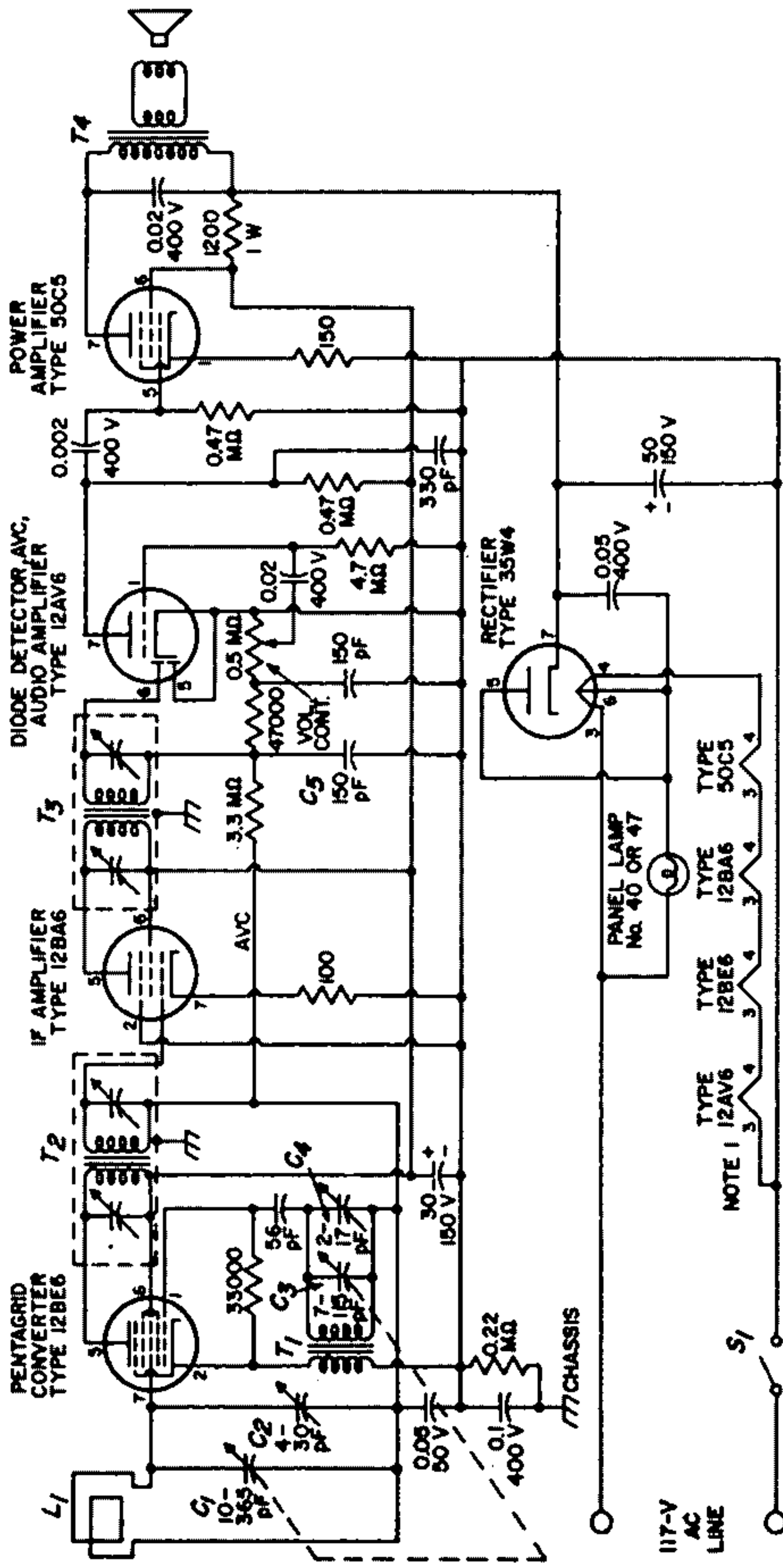
### LIST OF CIRCUITS

	Page
25-1 AC/DC Superheterodyne Radio Receiver .....	522
25-2 AM/FM Superheterodyne Radio Receiver .....	524
25-3 FM Tuner .....	528
25-4 FM Stereo Multiplex Adapter .....	531
25-5 Three-Stage IF Amplifier/Limiter and Detector .....	534
25-6 Preamplifier for Amateur Receiver (21-, 30-, and 50-MHz Amateur Bands and 27-MHz Citizens Band) .....	536
25-7 Code-Practice Oscillator .....	538
25-8 Citizens-Band Transceiver (26.965 to 27.255 MHz) .....	540
25-9 Intercommunication Set (With Master Unit and Two or More Remote Units) .....	544
25-10 High-Fidelity Audio Amplifier (Class AB <sub>1</sub> ; Power Output, 15 Watts) .....	546
25-11 High-Fidelity Audio Amplifier (Class AB <sub>1</sub> ; Power Output, 30 Watts) .....	548
25-12 High-Fidelity Audio Amplifier (Class AB <sub>1</sub> ; Power Output, 50 Watts) .....	550
25-13 Two-Channel Stereophonic Amplifier (Power Output, 1 Watt Each Channel) .....	552
25-14 Microphone and Phonograph Amplifier (Power Output, 8 Watts) .....	554
25-15 Two-Channel Audio Mixer .....	556
25-16 Phonograph Amplifier (Power Output, 1 Watt) .....	557
25-17 Preamplifier for Magnetic Phonograph Pickup (With RIAA Equalization) .....	558
25-18 High-Fidelity Preamplifier for Tape-Head Pickup (With NARTB Equalization) .....	560
25-19 Preamplifier for Ceramic Phonograph Pickup (Cathode-Follower Output) .....	562
25-20 Low-Distortion Preamplifier (For Low-Output, High-Impedance Microphones) .....	563

## CIRCUITS

25-21	Bass and Treble Tone-Control Amplifier .....	564
25-22	Sine-Square-Wave Audio Signal Generator .....	566
25-23	Electronic Volt-Ohm Meter .....	570
25-24	Cathode-Ray Oscilloscope .....	574
25-25	All-Purpose Power Supply .....	578
25-26	VHF Tuner (For Black-and-White TV Receiver) .....	581
25-27	Video IF Amplifiers and Sound-Channel Circuits (For Black-and-White TV Receiver) .....	585
25-28	Video, AGC, and Sync Amplifiers, (For Black-and-White TV Receiver) .....	588
25-29	Vertical and Horizontal Deflection Circuits and High-Voltage Rectifier (For Black-and-White TV Receiver) .....	591
25-30	Low-Voltage and Heater Supply (For Black-and-White TV Receiver) .....	596

25-1 AC/DC SUPERHETERODYNE RADIO RECEIVER



**L<sub>1</sub>** = Loop antenna or ferrite-rod antenna, 540 to 1600 KHz (with specified values of tuning and trimmer capacitance)  
**T<sub>1</sub>** = Oscillator coil for use with 7- to 115-pF tuning capacitor and 455-kHz intermediate-frequency transformer  
**T<sub>2</sub>**, **T<sub>3</sub>** = Intermediate frequency transformers (include if trimmer capacitors), 455 kHz  
**T<sub>4</sub>** = Audio output transformer matched impedance of speaker voice coil to 2500-ohm tube plate load  
**Notes:** 1. Resistance in ohms and capacitance in microfarads unless otherwise specified.  
 2. All resistors 0.5 watt unless otherwise specified.  
 3. The following tube types may be used for a 100-mA heater complement: 18FX6A converter, 18FW6A if amplifier, 18FY6A detector and audio amplifier, 34GD5A power amplifier, and 36AM3B rectifier.



## AC/DC SUPERHETERODYNE RADIO RECEIVER (Cont'd)

## Circuit Description

This basic five-tube superheterodyne radio receiver operates directly from an ac power line or a dc supply of 117 volts. AC power inputs are converted to dc power by the 35W4 half-wave rectifier circuit. The receiver uses a series heater arrangement. With ON-OFF switch S<sub>1</sub> closed, the heater string is connected directly across the 117-volt input terminals. A 6.3-volt panel lamp connected between heater pins 3 and 6 of the 35W4 rectifier tube lights to indicate that power is applied to the receiver.

A ferrite-rod or loop antenna L<sub>1</sub> and tuning capacitor C<sub>1</sub> select amplitude-modulated rf signals from the desired broadcast-band (550 to 1800 kHz) radio station and couple these signals to grid No. 3 (pin 7) of the 12BE6 pentagrid converter. A local-oscillator signal, developed by the resonant circuit formed by oscillator coil T<sub>1</sub> and variable capacitors C<sub>2</sub> and C<sub>3</sub>, is also applied to the 12BE6 pentagrid converter, at grid No. 1 (pin 1). The modulated-rf and local-oscillator signals are mixed across the nonlinear impedance of the converter

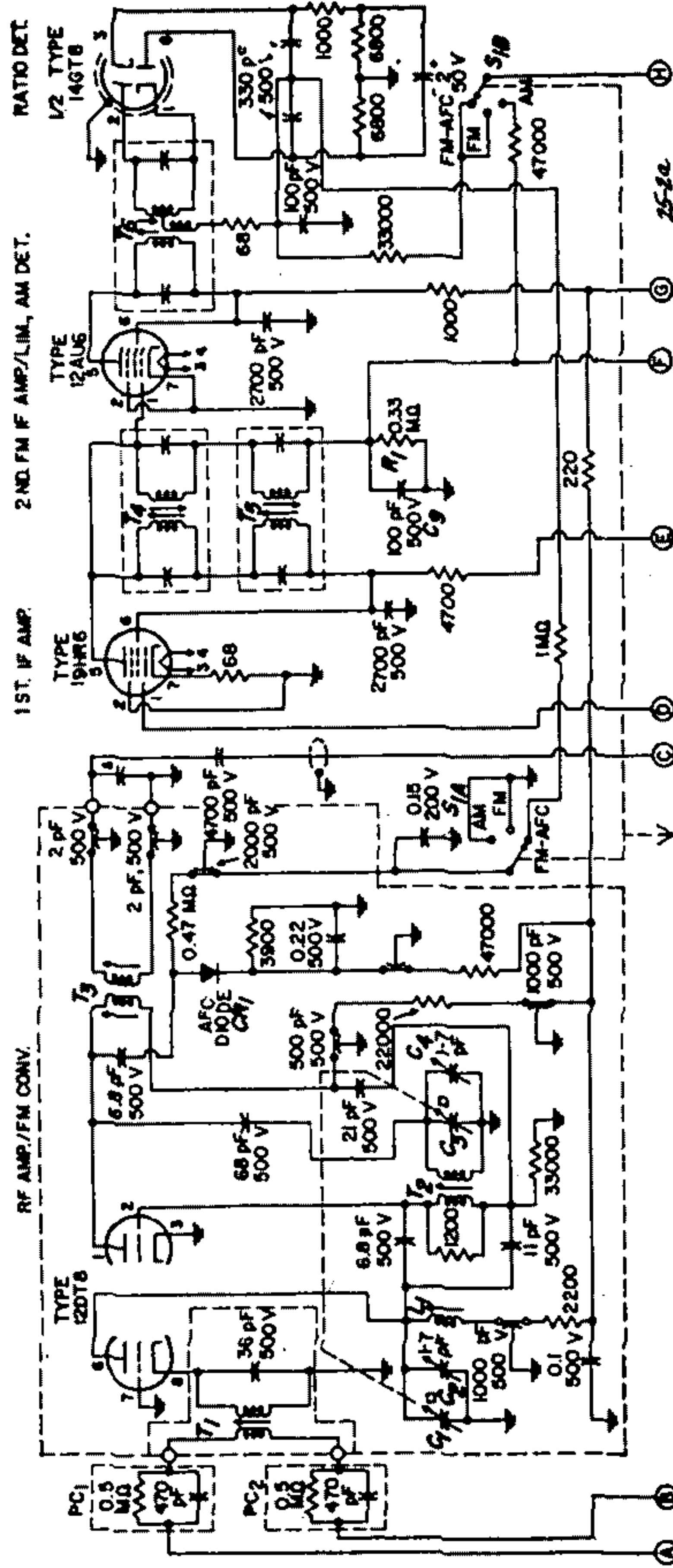
tube to produce the 455-kHz intermediate frequency used in the receiver. The antenna and oscillator tuning capacitors C<sub>1</sub> and C<sub>2</sub> are mechanically ganged so that the antenna and oscillator resonant circuits can be adjusted together to maintain the 455-kHz difference frequency for any dial setting in the broadcast-frequency band. Trimmer capacitors C<sub>4</sub> and C<sub>5</sub> are adjusted to assure that the desired tracking relationship is maintained across the band. Positive feedback to sustain oscillations is inductively coupled by T<sub>1</sub> from the cathode of the 12BE6 converter to the local-oscillator resonant circuit.

A single if stage, which uses a high-transconductance 12BA6 remote-cutoff pentode, provides the required amplification of the intermediate-frequency signals. This stage is made selective at 455 kHz by the double-tuned input and output transformers T<sub>2</sub> and T<sub>3</sub>. Audio-signal components are extracted from the if signal by the second-detector circuit, which consists of the pin 6 diode section in the 12AV6 tube and associated

components. (The pin 6 diode section of the 12AV6 is not used and is shorted to the tube cathode, pin 2.) The audio output from the detector is developed across the VOL. CONT. potentiometer, which provides manual adjustment of the output sound level of the receiver. The detector also develops a negative dc voltage proportional to the rf input across a 150-picofarad capacitor C<sub>6</sub> for automatic volume control in the receiver. This avc voltage, which is used as bias for the converter and if amplifier, automatically controls the gain of these stages.

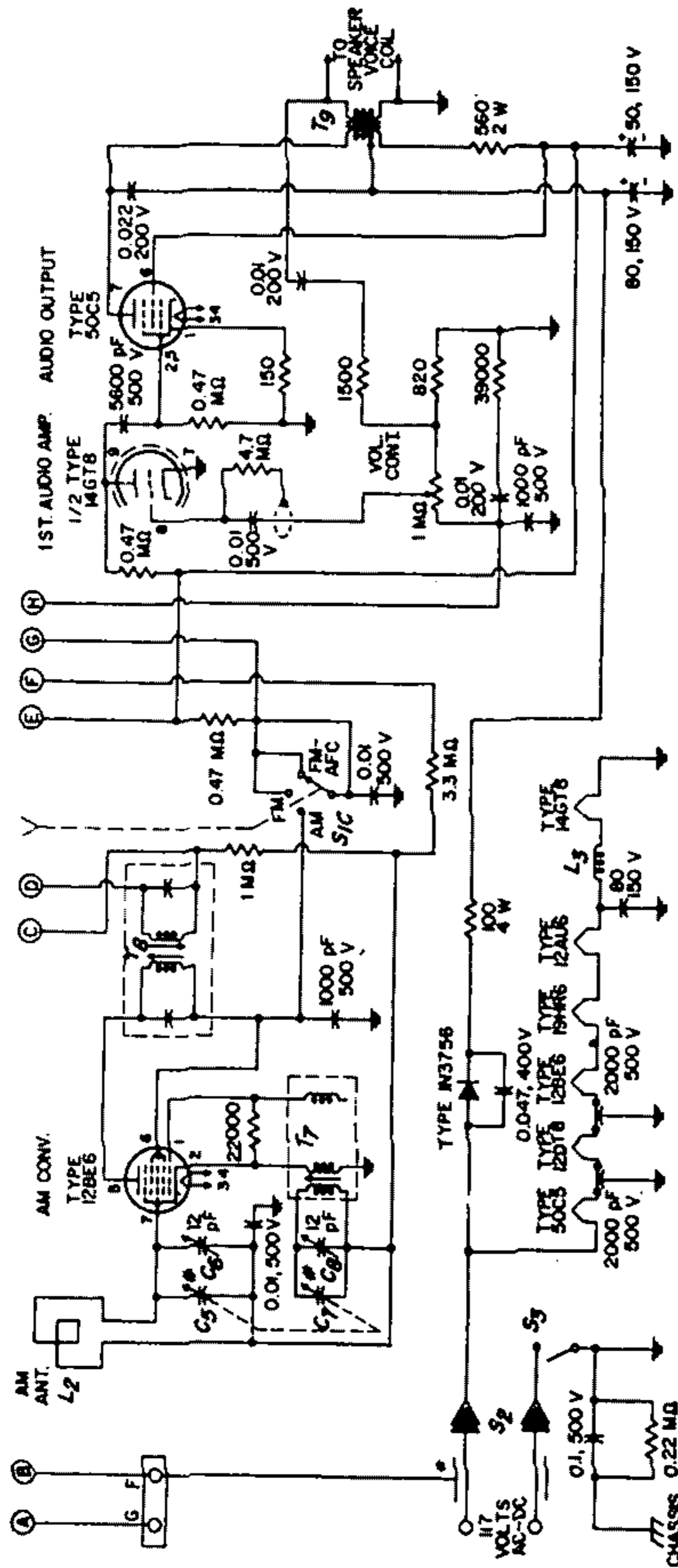
The audio-signal voltage at the wiper arm of the VOL. CONT. potentiometer is amplified by the triode (audio-voltage-amplifier) section of the 12AV6 and is then used to drive the 50C5 audio output stage. The output stage develops the audio power required to produce an audible output from the speaker. Audio output transformer T<sub>4</sub> matches the 2500-ohm plate-load impedance of the 50C5 to the speaker voice coil.

25-2 AM/FM SUPERHETERODYNE RADIO RECEIVER



- L<sub>1</sub> = RF coil
- L<sub>2</sub> = AM antenna, air loop with back cover
- P<sub>C1</sub> P<sub>C2</sub> = Printed circuit; includes 0.5-megohm, 0.25-watt resistor and 470-picofarad 500-volt capacitor; RCA Stock No. 104328 or equiv.
- T<sub>1</sub> = FM antenna transformer
- T<sub>2</sub> = FM oscillator transformer
- T<sub>3</sub>T<sub>4</sub> = FM if transformer, 10.7 MHz
- T<sub>5</sub>T<sub>6</sub> = AM if transformers, 455 kHz
- T<sub>7</sub> = Ratio-detector transformer, 10.7 MHz
- T<sub>7</sub> = AM Oscillator coil; with specified values of tuning and trimmer capacitance, tunes to 540 to 1600 kHz
- T<sub>8</sub> = Audio output transformer, matches impedance of speaker voice coil to 2500-ohm tube load.

25-2 AM/FM SUPERHETERODYNE RADIO RECEIVER (Cont'd)



- Ganged tuning capacitors; tune  $L_1$  and  $T_1$  to 80 to 108 MHz.
  - # Ganged tuning capacitors; tune AM antenna ( $L_2$ ) and  $T_1$  to 540 to 1650 kHz.
  - △ IF transformer tuning capacitor; value, with cable capacitance, tunes  $T_1$  to 10.7 MHz.
  - \* On FM, the ac line serves as an FM antenna by means of a special line cord having a third wire which is not physically connected to the line. Alternatively, an external FM antenna may be connected to terminals G and F with the connection to the third wire of the power cord omitted.
- Notes:
1. Resistance in ohms and capacitance in microfarads unless otherwise specified.
  2. All resistors 0.5 watt,  $\pm 10\%$  unless specified.
  3. See general considerations for construction of high-frequency and broadband circuits on page 519.

### Circuit Description

This AM/FM radio receiver operates directly from either an ac power line or a dc supply of 117 volts. AC power inputs are converted to dc power by a 1N3756 silicon-rectifier half-wave power supply. The receiver uses a series heater string, which is connected across the 117-volt input when ON-OFF switch  $S_2$  and interlock  $S_4$  are closed. The interlock assures that power is automatically disconnected when the receiver is removed from the chassis.

AM or FM operation of the receiver is selected by means of switch  $S_1$ . For AM operation ( $S_1$  set to AM position), amplitude - modulated rf signals in the AM broadcast band (550 to 1600 kHz) from the desired radio broadcast station are selected by antenna  $L_2$  and tuning capacitor

$C_2$ . These signals are amplified and converted to the 455-kHz AM intermediate frequency by the 12BE6 pentagrid converter. Tuning capacitors  $C_3$  and  $C_7$  are mechanically ganged so that the antenna and local-oscillator sections of the converter can be tuned simultaneously to maintain the 455-kHz difference frequency for any station setting. Trimmer adjustments are provided by variable capacitors  $C_4$  and  $C_6$ .

With switch  $S_1$  in the FM or FM-AFC position, the FM tuner selects rf signals in the FM broadcast band (88 to 108 MHz) from the desired FM radio station, amplifies these signals, and converts them to the 10.7-MHz FM intermediate frequency. The rf-amplifier and converter stages of the tuner each use one section of a

12DT8 high- $\mu$  twin triode. Ganged tuning of the rf-amplifier and converter tuning capacitors,  $C_1$  and  $C_5$ , assures that the converter local-oscillator frequency tracks the input tuning at 10.7 MHz above the center frequency of the FM channel selected. Trimmer adjustments are provided by variable capacitors  $C_3$  and  $C_4$ . For FM operation, the ac line may serve as the antenna if a special line cord containing a third wire not physically connected to the line is employed. Alternatively, an external FM antenna may be connected to terminals G and F with the connection to the third wire of the power cord omitted.

The 19HR6 if amplifier is used in both FM and AM modes of operation. Depending upon the setting of selector switch  $S_3$ , this stage ampli-



## 25-2 AM/FM SUPERHETERODYNE RADIO RECEIVER (Cont'd)

### Circuit Description (Cont'd)

fies the frequency-modulated 10.7-MHz intermediate-frequency output from the FM converter or the amplitude-modulated 455-kHz intermediate-frequency signal from the AM converter. Additional amplification of FM if signals is provided by the 12AU6 pentode stage, which is used as a combination second FM if amplifier and noise limiter. A portion of the 12AU6 stage is also used as a second detector circuit to extract the audio-signal components from the 455-kHz AM if signals. For this demodulation function, the cathode and control grid of the 12AU6 are used as the detector diode. The 10.7-MHz FM if signals are demodulated and amplitude distortion is removed by a ratio detector that uses the diode sections of a 14GT8 twin diode—high-

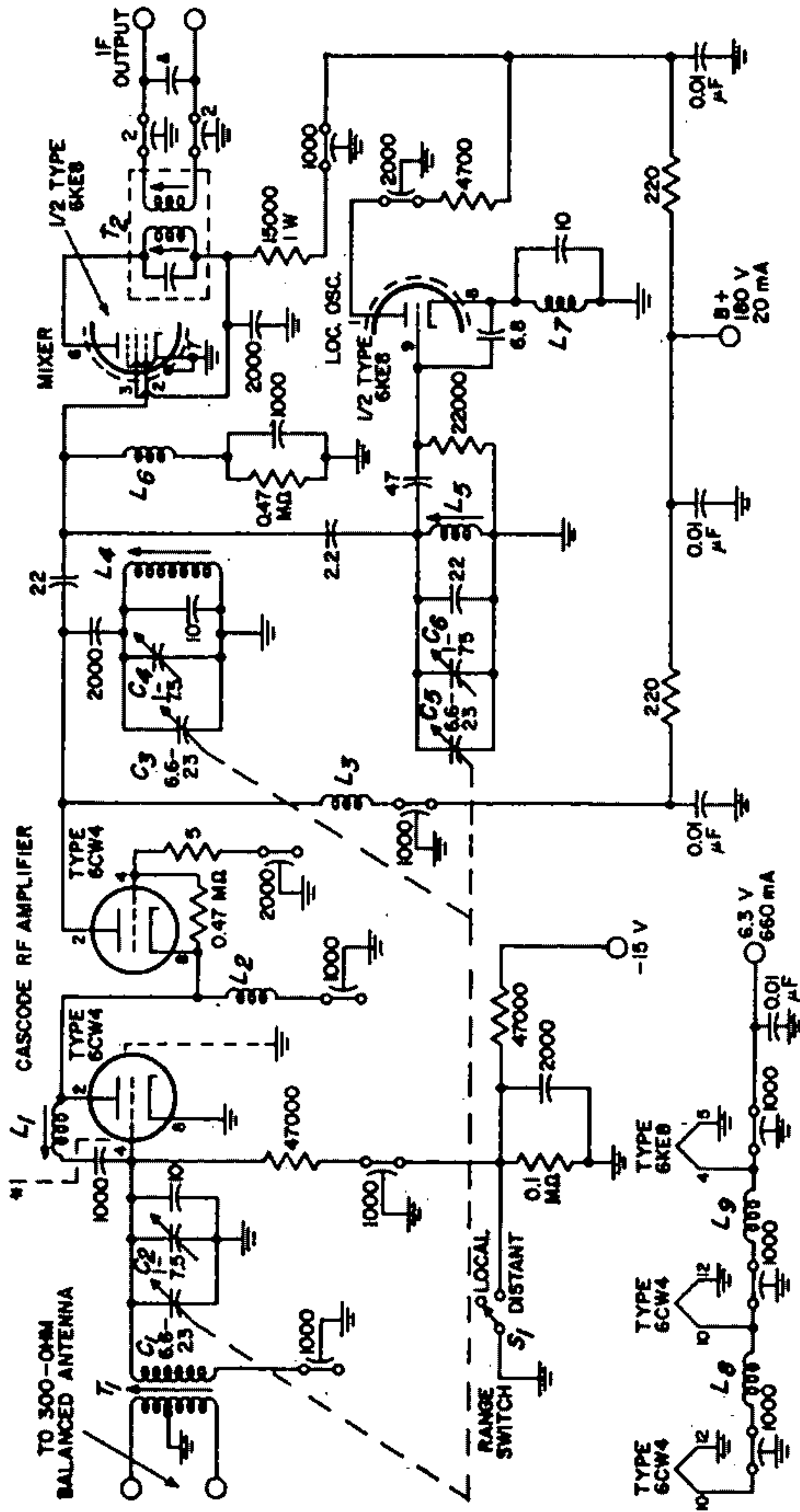
mu triode. Good selectivity in the if amplifier and detector at 10.7 MHz is provided by the double-tuned transformers T<sub>4</sub>, T<sub>5</sub>, and T<sub>6</sub>, and at 455 kHz by the double-tuned transformers T<sub>1</sub> and T<sub>2</sub>.

Depending upon the mode of operation, a section of S<sub>1</sub> selects the audio output from the AM detector or from the FM ratio detector. The selected audio output is amplified by an audio voltage amplifier which uses the high- $\mu$  triode section of a 14GT8 and a 50C5 audio output stage. The output stage provides the power necessary to produce the required speaker output. Transformer T<sub>7</sub> matches the 2500-ohm plate impedance of the 50C5 to the speaker voice coil. Manual adjustment of the receiver output is provided by the

70L CONT. potentiometer in the control-grid circuit of the audio voltage amplifier.

A negative dc voltage proportional to the input signal level is developed across R<sub>1</sub> and C<sub>1</sub> during either AM or FM operation of the receiver. This voltage is applied as bias to the control grid (pin 1) of the 19HR6 if amplifier and the signal grid (pin 7) of the 12BE6 AM converter to provide automatic gain control of the receiver in each mode of operation. With S<sub>1</sub> in the FM-AFC position, the AFC diode CR<sub>1</sub> rectifies the voltage across the tertiary winding of the ratio-detector transformer T<sub>4</sub>. The resultant frequency-sensitive voltage, applied to the plate resonant circuits of FM rf-amplifier and converter stages, provides automatic frequency control in the FM tuner.

25-3 FM TUNER



- A metal shield should be provided between grid and plate terminals on the 6CW4 socket.
- Capacitor inserted in place of tuning capacitor in secondary winding of  $T_2$ . Value with cable capacitance tunes output circuit of tuner to 10.7 Mc/s.

$L_1$  = RF coil, 12 turns of No. 22 enamel wire close-wound on  $\frac{1}{4}$ -inch-diameter slug-tuned coil form; tuning slug =  $\frac{3}{8}$ -inch-long Moldite No. 5101 ferrite or equiv.

$L_2$  = RF coil, 5 turns of No. 22 enamel wire close-wound on  $\frac{1}{4}$ -inch-diameter coil form

$L_3$  = RF choke, 4  $\mu$ H, J. W. Miller No. 70F396A1 or equiv.

$L_4$  = RF coil, 3 turns of No. 16 enamel wire wound double-spaced on  $\frac{1}{4}$ -inch-diameter slug-tuned coil form; tuning slug =  $\frac{3}{8}$ -inch-long Moldite No. 5101 ferrite or equiv.

$L_5$  = RF coil,  $1\frac{1}{2}$  turns of No. 16 enamel wire close-wound on  $\frac{1}{4}$ -inch-diameter slug-tuned coil form; tuning slug =  $\frac{3}{8}$ -inch-long Moldite No. 5101 ferrite or equiv.

$L_6$  = RF choke, 2  $\mu$ H, Ohmite No. Z144 or equiv.

$L_7$  = RF coil; 0.4  $\mu$ H; 20 turns of No. 26 enamel wire close-wound on a 0.47 megohm, 0.5w Allen-Bradley resistor or resistor of equivalent physical size

$L_8$  = RF chokes; 1  $\mu$ H; 25 turns of No. 24 enamel wire close-wound on a 0.47-megohm, 1-watt Allen-Bradley

resistor or resistor of equivalent physical size

$T_1$  = Antenna transformer; primary: 2 turns of No. 32 wire with type B nylon insulation, Alpha No. 1860 or equivalent, center-tapped; secondary: 3 turns of No. 16 enamel wire; wound double-spaced on  $\frac{1}{4}$ -inch-diameter slug-tuned coil form; tuning slug =  $\frac{3}{8}$ -inch-long Moldite No. 5101 ferrite or equiv.

$T_2$  = FM if transformer, 10.7 MHz, J. W. Miller 1451 or equiv.; capacitor in secondary should be replaced by one shown connected across tuner output terminals (see footnotes  $\Delta$ )

- Notes: 1. Resistances in ohms and capacitance in picofarads unless otherwise specified.  
 2. All resistors 0.5 watt and all capacitors 400 volts unless otherwise specified.  
 3. See general considerations for construction of high-frequency and broadband circuits on page 519.

### Circuit Description

This three-stage FM tuner features a pair of 6CW4 nuvistor triodes operated in a low-noise, high-gain cascode rf-amplifier stage. The mixer and local-oscillator sections of the tuner use the pentode and triode sections, respectively, of a 6KE8 triode-pentode. The dc operating power for the tuner is obtained from a 180-volt, 20-milliampere supply. Power for the tube heaters is obtained from a 6.3-volt, 660-milliampere ac source.

The tuner uses a 800-ohm balanced antenna. Antenna transformer

T<sub>1</sub> matches the 800-ohm antenna impedance to the input circuit of the cascode rf amplifier. Antenna tuning capacitor C<sub>1</sub> is adjusted to select the desired FM channel. The frequency-modulated rf signals are amplified by the cascode rf stage and coupled to the control grid of the mixer stage. The local oscillator generates a signal, at a frequency 10.7 MHz above the center frequency of the selected FM channel, which is also applied to the control grid of the mixer stage. The rf and local-oscillator signal are

mixed to produce the desired 10.7-MHz FM intermediate frequency. Ganged tuning of the antenna, mixer, and local-oscillator tuning capacitors, C<sub>1</sub>, C<sub>2</sub>, and C<sub>3</sub>, assures that the local-oscillator frequency tracks the input tuning at 10.7 MHz above the selected FM channel. Capacitors C<sub>2</sub>, C<sub>3</sub>, and C<sub>4</sub> are trimmer adjustments for the tuner. The double-tuned transformer T<sub>2</sub> selects the 10.7-MHz FM if signals at the plate of the mixer stages and couples them to the if-amplifier/limiter section of the FM receiver.



This FM stereo multiplex adapter demodulates composite multiplex signals from an FM tuner and separates these signals into left- and right-channel inputs for stereo audio-output stages. The dc operating power for the 12AX7A and 6CL8A twin triodes used in the adapter circuit is obtained from a 180-volt, 15-milliamperes supply. Power for the dual heaters of the 12AX7A and the single heater of the 6CL8A is obtained from a 6.3-volt source.

The composite signal applied to the multiplex adapter from the ratio detector (or discriminator) in an FM receiver includes a 19-kHz pilot-frequency (multiplex-reference) component and sum ( $L + R$ ) and difference ( $L - R$ ) components of left- and right-channel audio signals. The  $L + R$  signal is the demodulated in-phase combination of the left- and right-channel audio information used to modulate the main carrier frequency of the receiver. The  $L - R$  signal is

the out-of-phase combination of the left- and right-channel information and is used to amplitude-modulate a 38-kHz subcarrier. This subcarrier is suppressed in the FM tuner so that only the  $L - R$  sideband components of the amplitude-modulated signal remain.

The composite input signal is amplified by the 12AX7A triode section in the input stage of the adapter. The high input impedance of this stage prevents excessive loading of the ratio detector. The 67-kHz trap in the cathode circuit of this stage eliminates any SCA (storecast allocation) signal components that may be included in the composite signal. The composite signal is coupled from the plate of the input stage to the control grid of the 6CL8A triode section used in a signal-separation driver. This stage operates as a cathode follower for the  $L + R$  audio components and the  $L - R$  subcarrier sideband components. The  $L +$

$R$  audio components are developed across the MATRIX BALANCE ADJ. potentiometer and coupled from the wiper arm of this potentiometer to the output resistor matrix network. A 3300-picofarad capacitor in the coupling circuit filters out any 19-kHz pilot-frequency components or 38-kHz subcarrier sideband components that may be developed across the balanced potentiometer. The  $L - R$  sideband components are coupled from the cathode of the signal-separation driver to the center tap of the secondary winding of the transformer  $T_1$  in the peak detector. The 38-kHz band-pass coil  $L_1$  and the 67-kHz series-resonant trap assure maximum signal transfer of the  $L - R$  sideband components with minimum interference from storecast signals.

The 19-kHz double-tuned transformer  $T_1$  in the plate circuit of the signal-separation driver presents a highly selective load to the 19-kHz pilot-frequency component included



$CR_1$ ,  $CR_2$ ,  $CR_3$ ,  $CR_4$  = Crystal diode,  
RCA stock No. 111207 or equiv.  
 $L_1$ ,  $L_2$  = RF coil, 67-kHz trap, RCA  
stock No. 111047 or equiv.

$L_3$  = RF coil, 39-kHz band pass, RCA  
stock No. 111048 or equiv.  
 $T_1$  = RF interstage coupling transformer,  
19-kHz, RCA stock No. 111045 or  
equiv.

$T_2$  = RF interstage coupling transformer,  
38-kHz, RCA stock No. 111046 or  
equiv.

#### Circuit Description (Cont'd)

in the composite multiplex signal and couples this 19-kHz component to the pilot-frequency doubler. The doubler circuit, which consists of two diodes ( $CR_1$  and  $CR_2$ ) in a full-wave rectifier configuration, doubles the pilot frequency to regenerate the 38-kHz subcarrier required for demodulation of the L - R sideband components.

The 38-kHz output of the doubler is amplified by the 6CL8A triode section used in the shaping amplifier and reshaped to a sine wave by the tuned primary of the peak detector transformer  $T_1$ . In the secondary of  $T_1$ , the 38-kHz subcarrier is recom-

bined with the L - R sideband components from the cathode of the signal-separation driver. This combined signal is then demodulated by detector diodes  $CR_3$  and  $CR_4$  to obtain the L - R audio signal.

The L - R audio signal is applied to the control grid of the 6CL8A section used in a phase-splitter circuit. The cathode and plate outputs of the phase splitter are equal in amplitude and opposite in phase so that one output represents an L - R signal and the other output represents a - L + R signal. These signals are applied to the output-resistor matrix network

where they are added to the L + R audio signal from the cathode circuit of the signal-separation driver. In the summation of the L + R and L - R audio signal, the R components are canceled, and the resultant obtained is the left-channel audio output. The summation of the L + R and - L + R signals results in cancellation of the L components so that only the right-channel audio output is obtained. These outputs are then applied to the stereo receiver left- and right-channel audio-output stages, respectively.





- Notes: 1. Resistances in ohms and capacitance in picofarads unless otherwise specified.  
 2. All resistors 0.5 watt and all capacitors 400 volts unless otherwise specified.  
 3. Tube shields may be required if regeneration is encountered. See general considerations for construction of high-frequency and broadband circuits on page 519.

### Circuit Description

This three-stage if amplifier/limiter and detector circuit, when used with a front-end circuit such as that shown in circuit 25-3, makes possible an over-all tuner gain of 35 dB. The over-all bandwidth of the if-amplifier stages, between the 6-dB-down points, is 300 kHz, and the peak separation of the detector is 440 kHz. The circuit provides a signal-to-noise ratio of 20 dB for an input of 2.8 microvolts or 30 dB for an input of 4.1 microvolts. The 6HR6 and 6HS6 pentodes used in the if-amplifier stages have very high transconductance and a grid-No.1-to-plate capacitance substantially less than 0.01 picofarad and are, therefore, especially suited for use in FM if amplifiers and television sound if amplifiers. These pentodes operate from a 180-volt, 25-milliampere dc supply. Heater power for the pentodes and for the 6AL5 twin diode used in the ratio detector is obtained from a 6.3-

volt ac supply.

The frequency-modulated, 10.7-MHz intermediate-frequency signal from the mixer stage in the FM tuner is applied to the control grid of the first if-amplifier stage. This signal is amplified by the three transformer-coupled amplifier stages and applied by transformer T<sub>1</sub> to the ratio detector. The doubled-tuned coupling transformer T<sub>1</sub>, T<sub>2</sub>, and T<sub>3</sub> provide the selectivity at 10.7 MHz and the band-pass characteristics required for optimum transfer of the frequency-modulated signal. Circuit stability is improved by the use of unbypassed cathode resistors in each amplifier stage. The first two if stages are basically amplifiers, although they provide some saturation limiting of large-level signals. The 3800-ohm screen-grid dropping resistors reduce the screen-grid voltages in these stages to obtain the desired limiting characteristics. The 6HR6 pentode

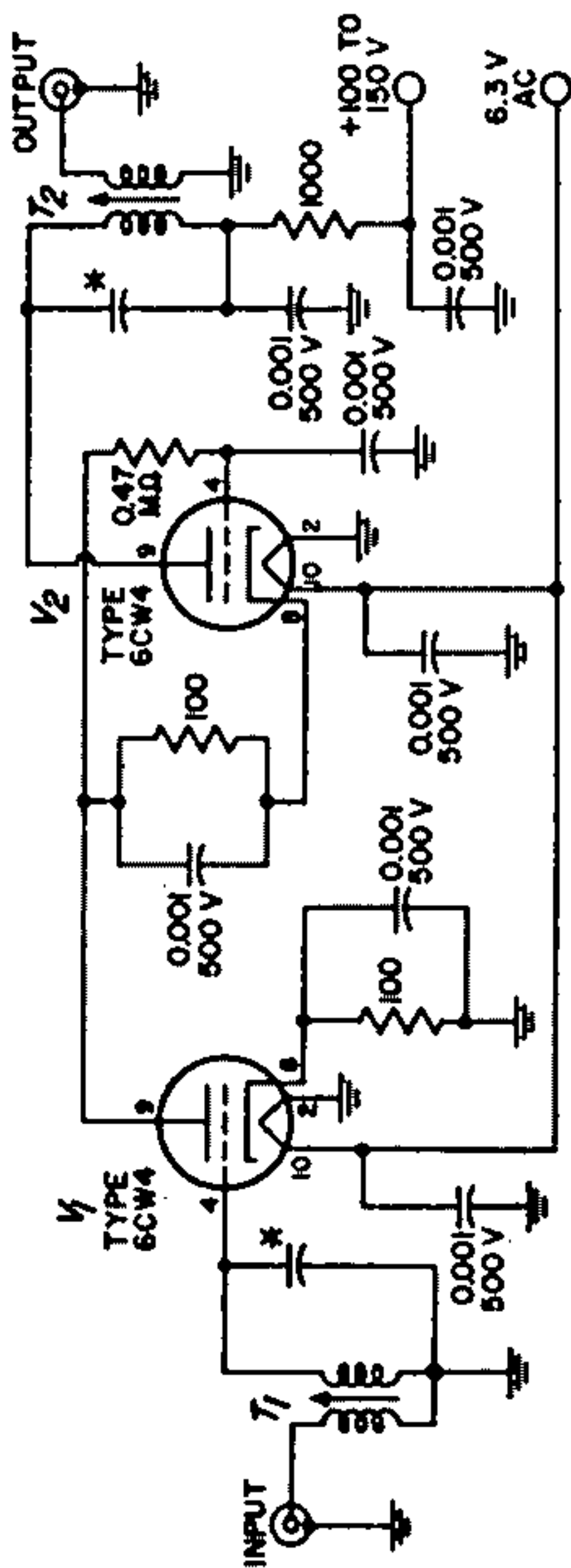
used in the first if amplifier is a remote-cutoff tube and, if desired, this stage may be operated with age bias. The 6HS6 pentodes used in the second and third if stages are sharp-cutoff tubes. In addition, the screen-grid voltage divider network for the third stage substantially reduces the screen-grid voltage so that the stage will provide both cutoff and saturation limiting of large-level signals. The limiting in the if stages helps remove any amplitude modulation from the frequency-modulated signals.

The 6AL5 ratio-detector circuit provides additional noise limiting of the FM signal and demodulates this signal to recover the audio information. The detector circuit provides the input to the audio amplifiers of a monaural receiver or to the multiplex detector in a stereo system. The RC network in the monaural output lead provides the desired de-emphasis of high audio frequencies.

- L<sub>1</sub> L<sub>2</sub> L<sub>3</sub> = RF choke, 1 μH  
 T<sub>1</sub> T<sub>2</sub> = IF transformers, 10.7 MHz, includes capacitors across primary and secondary windings  
 T<sub>3</sub> = Ratio-detector transformer, 10.7 MHz, includes capacitor across secondary winding.

## 25-6 PREAMPLIFIER FOR AMATEUR RECEIVER

For 15-, 10-, and 6-Meter (21, 30-, and 50-MHz) Amateur Bands and 27-MHz



T<sub>1</sub> = Input transformer (slug-tuned); matches preamplifier to 52-ohm input line (for 300-ohm input line, double number of turns in primary); wound from #32 copper enamel wire on slug-tuned form having ¼-inch outer diameter; primary, 1½ turns; secondary, 18 turns for operation at 21, 27, or 30 MHz or 10 turns for operation at 50 MHz

T<sub>2</sub> = Output transformer (slug-tuned); matches preamplifier to 72-ohm output line (use of other than a 72-ohm line between preamplifier output and receiver input is not recommended); wound from #32 copper enamel wire on slug-tuned form having ¼-inch outer diameter; primary, 18 turns for operation at 21, 27, or 30 MHz or 10 turns for operation at 50 MHz, secondary, 1½ turns

ALIGNMENT DATA		
Operating Frequency	Tune T <sub>1</sub> for	Tune T <sub>2</sub> to:
21 MHz	21.25 MHz	21.22 MHz
27 MHz	30 MHz	27 MHz
30 MHz	32 MHz	29.5 MHz
50 MHz	51 MHz	50 MHz

\* For operation at 21 or 27 MHz, use 6.8-pF 500-volt capacitors across secondaries of T<sub>1</sub> and T<sub>2</sub>; for operation at 30 MHz, use 5-pF 500-volt capacitor across secondary of each transformer; for operation at 50 MHz, use 5-pF 500-volt capacitor across secondary of T<sub>1</sub> and 6.8-pF 500-volt capacitor across secondary of T<sub>2</sub>.

- Notes:
1. Resistance in ohms and capacitance in microfarads unless otherwise specified.
  2. All resistors 0.5 watt unless otherwise specified.
  3. See general considerations for construction of high-frequency and broadband circuits on page 519.

## 25-6 PREAMPLIFIER FOR AMATEUR RECEIVER (Cont'd)

## Circuit Description

In this preamplifier, two 6CW4 high- $\mu$  nuvistor triodes are used in a high-gain, low-noise cascode rf-amplifier stage that adds 25 to 35 dB of gain ahead of a receiver operated on the 6-, 10-, or 15-meter amateur band or on the 27-MHz citizens band. This added gain, together with the low noise figure (approximately 5 dB) of the preamplifier, substantially increases both the sensitivity and the signal-to-noise ratio of the receiver. The preamplifier operates from a dc plate supply of 150 volts at 5 milliamperes. The tube heaters require an ac power input of 6.3 volts at 0.26 amperes. These small power requirements can usually be provided by the receiver.

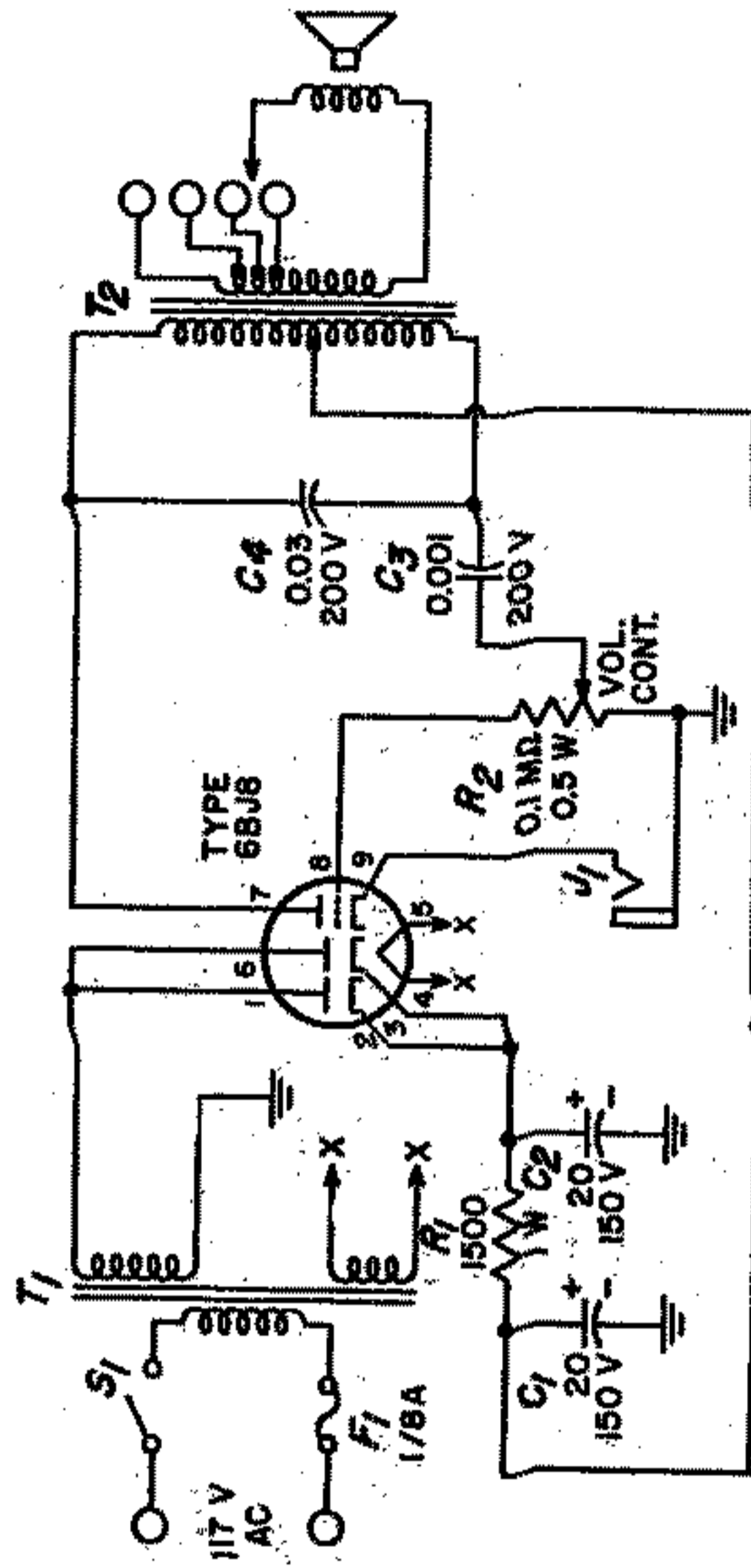
Input transformer T<sub>1</sub> matches the high input impedance of the preamplifier to a 72-ohm or 300-ohm an-

tenna. When a 72-ohm antenna is used, the primary of T<sub>1</sub> consists of a 1½-turn link wound about the hot end of the secondary coil. For a 300-ohm antenna, a 3-turn link is used. The secondary of T<sub>1</sub> is an 18-turn coil for operation at 10 or 15 meters or on the citizens band. At 6 meters, a 10-turn secondary coil is used. The unit is normally connected to the antenna cable by means of a coaxial connector. If a balanced antenna system is used, however, terminal strips for the twin leads may be used instead of the coaxial connector. In this latter case, the input link (primary of T<sub>1</sub>) is not grounded.

Nuvistors V<sub>1</sub> and V<sub>2</sub> are operated in a stacked (cascode) arrangement in series with the B<sup>+</sup> supply. The input is coupled by T<sub>1</sub> to the control grid of V<sub>1</sub>, which is essentially a

grounded-cathode amplifier. The output of V<sub>1</sub> is applied to the cathode of V<sub>2</sub>, which is basically a grounded-grid amplifier. The inherent stability of this type of arrangement, together with the ample decoupling and bypassing networks included in the circuit provide assurance that the preamplifier will not break into oscillation.

The output of V<sub>2</sub> is developed across the primary coil of output transformer T<sub>2</sub>. This coil is identical to the secondary coil of input transformer T<sub>1</sub>. The secondary of T<sub>2</sub> consists of a 1½-turn link about the primary coil. This link matches the output of the preamplifier to a 75-ohm receiver input cable. (The maximum length of coaxial cable between receiver and preamplifier should not exceed 12 inches.)



T<sub>1</sub> = Power transformer, 125 volts rms, 15 mA; 6.3 volts, 0.6 ampere  
 T<sub>2</sub> = Universal output transformer

- Notes: 1. Any two terminals of the secondary of T<sub>2</sub> that give the desired tone may be selected. Adjustment of volume control may cause a slight change in tone.  
 2. Resistance in ohms and capacitance in microfarads unless otherwise specified.



### Circuit Description

This code-practice oscillator operates from a 117-volt ac power line. When ON-OFF switch  $S_1$  is closed, the 117-volt ac input power is stepped up to 125 volts across the upper secondary winding of power transformer  $T_1$ , and is stepped down to 6.3 volts across the lower secondary winding. The 6.3-volt winding provides the operating power for the heater of the 6BJ8 twin diode-triode used in the circuit. The diode sections of the 6BJ8 are connected to operate as a single diode in a half-wave rectifier circuit that converts the ac power across the 125-volt winding of  $T_1$  to dc operating power for the 6BJ8 triode section. This triode section is used as the am-

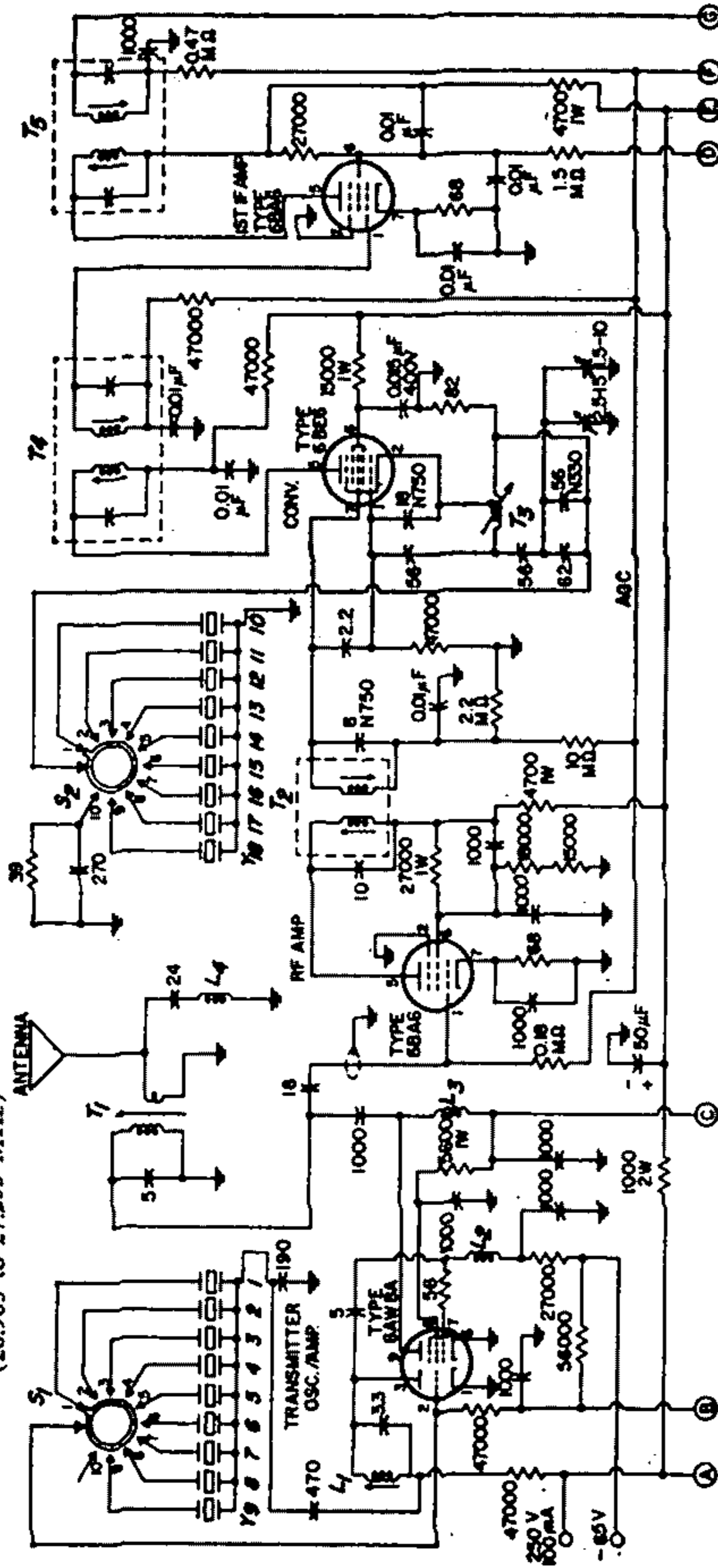
plifier tube in a simple audio-oscillator stage.

Operation of the oscillator stage is controlled by a telegraph key, which is connected into the circuit by means of jack  $J_1$ . When the key is closed, the triode section of the 6BJ8 supplies energy to the oscillator resonant circuit formed by capacitor  $C_1$  and the effective inductance of the primary of output transformer  $T_2$ . This circuit then resonates to produce an audio signal that is coupled by transformer  $T_2$  to the speaker to produce an audible indication of the keying. Positive feedback to sustain oscillation is developed by the auto-transformer action of the tapped pri-

mary of transformer  $T_2$ .

Output transformer  $T_2$  is a universal type which contains multiple taps on the secondary winding. These taps enable the transformer to match the oscillator output impedance to different values of speaker voice-coil impedance. The speaker impedance and transformer terminals used, however, affect the effective inductance in the primary of  $T_2$  and, thus, the tone of the audio output. Volume control potentiometer  $R_2$  adjusts the level of the audio output. Adjustment of potentiometer  $R_2$  varies the loading on the oscillator resonant circuit and may also cause a slight change in the tone of the audio output.

25-8 CITIZENS-BAND TRANSCEIVER  
(26.965 to 27.255 MHz)



CR1 = Crystal diode, type 1N34  
 L1 = Transmitter oscillator coil, RCA stock No. 226183 or equiv.  
 L2L3 = RF choke, 500  $\mu$ H  
 L4 = Second-harmonic trap, RCA stock No. 226187 or equiv.  
 S1 = Rotary switch, transmitter channel selector, RCA stock No. 226189 or equiv.

S2 = Rotary switch, receiver channel selector, RCA stock No. 226189 or equiv.  
 T1 = Transmitter output transformer, RCA stock No. 226184 or equiv.  
 T2 = RF interstage transformer, 26.965 to 27.255 MHz, RCA stock No. 226191 or equiv.  
 T3 = Receiver oscillator coil, RCA stock

No. 226192 or equiv.  
 T4, T5 = IF transformer (includes primary and secondary capacitors), 1650 kHz, RCA stock 226193 or equiv.  
 T7 = Audio output transformer, center-tapped primary, matches impedance of speaker voice coil to 5000-ohm tube load, RCA stock No. 226224 or equiv.  
 Y1 through Y6 = Transmitting crystals.  
 Y10 through Y12 = Receiving crystals.





## 25-8 CITIZENS-BAND TRANSCEIVER (Cont'd)

### Circuit Description

This transceiver provides reliable two-way radio voice communications in the 27-MHz citizens band. Separate switches ( $S_1$  and  $S_2$ ) are provided for selection of the transmit and receive channels. There are nine crystal positions for each mode of operation. If desired, however, the receiver may be tuned manually to any one of the 23 citizens-band channels without the use of receive crystals. The transceiver operates from a positive dc supply of 250 volts at 100 milliamperes. The tube heaters are connected in a series-parallel arrangement that permits them to be operated from an ac or dc supply of 12.6 volts. A bias supply of -65 volts is also required to mute the transmitting circuits during receiver operation. During transmission, a large negative voltage developed on the receiver agc line, as a result of the antenna feedthrough from the transmitter, cuts off the rf and if amplifiers of the receiver. In addition, the speaker is disconnected from the receiver by the push-to-talk switch ( $S_3$ ) on the microphone.

In the transmit mode of operation, push-to-talk switch  $S_3$  must be depressed to the TRANSMIT position. This action grounds the control grid circuits of the transmit oscillator

and the microphone amplifier, which removes the -65 volts of cutoff bias from these stages, and the rf and modulator sections of the transmitter are permitted to operate. In addition, the ground return is removed from the secondary of the receiver audio output transformer, and no output can be delivered to the speaker.

The rf section of the transmitting circuits include a crystal-controlled oscillator (triode section of 6AW8A) and a class C rf power amplifier (pentode section of 6AW8A). These circuits have a transmitter power rating of 5 watts (plate input power to final rf stage). The frequency of the oscillator is controlled by a third-overtone type of crystal (crystal positions are available for any 9 of the 23 citizens-band channels). The oscillator frequency can be adjusted over a small range by the variable inductor  $L_1$  in the oscillator plate circuit. The oscillator output signal is increased to the required power level by the power amplifier and is then delivered to the antenna. A filter network in the plate circuit of the power amplifier and tuned antenna transformer  $T_1$  form a selective output circuit that is designed to assure maximum transfer of power from the power amplifier to the antenna at

citizens-band frequencies and to provide the required harmonic rejection, as specified by FCC regulations.

The rf signals from the transmitting circuits are amplitude-modulated by audio signals applied to the plate circuit of the rf power amplifier (high-level modulation). As mentioned previously, the cutoff bias on the microphone amplifier is removed when the press-to-talk switch on the microphone is depressed. The microphone amplifier uses the triode section of a 6EA8 triode-pentode to provide the first level of amplification for the microphone audio outputs. The output of the microphone pre-amplifier is applied to the control grid of the triode section of a 6AV6 twin diode-triode used in an audio voltage amplifier stage. This stage increases the microphone signal to a level sufficient to drive a 6AQ5A pentode audio power amplifier. (The audio voltage and power amplifiers are also used as first-audio and output stages, respectively, during receiver operation.) The output from the audio power amplifier (modulator) is inductively coupled by the autotransformer action of the tapped primary of transformer  $T_2$  to the plate circuit of the rf power amplifier and amplitude-modulates the rf signals being deliv-



## 25-8 CITIZENS-BAND TRANSCEIVER (Cont'd)

### Circuit Description (Cont'd)

ered to the antenna.

The tuned antenna transformer  $T_1$  used to couple the transmitter rf output to the antenna is also used as the input circuit to the receiver. This transformer is designed not only to provide a maximum transfer of power to the antenna during transmission, but also to assure an optimum signal-to-noise ratio for receiver-mode operation. The received signals are coupled from the antenna by transformer  $T_1$  to the control grid of the 6BA6 receive rf amplifier. The output of the rf amplifier is coupled by the double-tuned transformer  $T_2$  to the signal input grid of the 6BE6 pentagrid converter, where it is mixed with a local-oscillator signal to derive the 1650-kHz intermediate frequency used in the receiver.

The oscillator portion of the receiver, depending upon the position of the receive channel-selector switch  $S_2$ , is either crystal-controlled (positions 1 through 9) or manually tunable (position 10). For crystal operation, the crystal is switched directly into the feedback path. At its series resonant frequency, the crystal acts as a closed switch; at any other frequency, the crystal acts effectively as an open circuit. Oscillations are sustained, therefore, at only the series

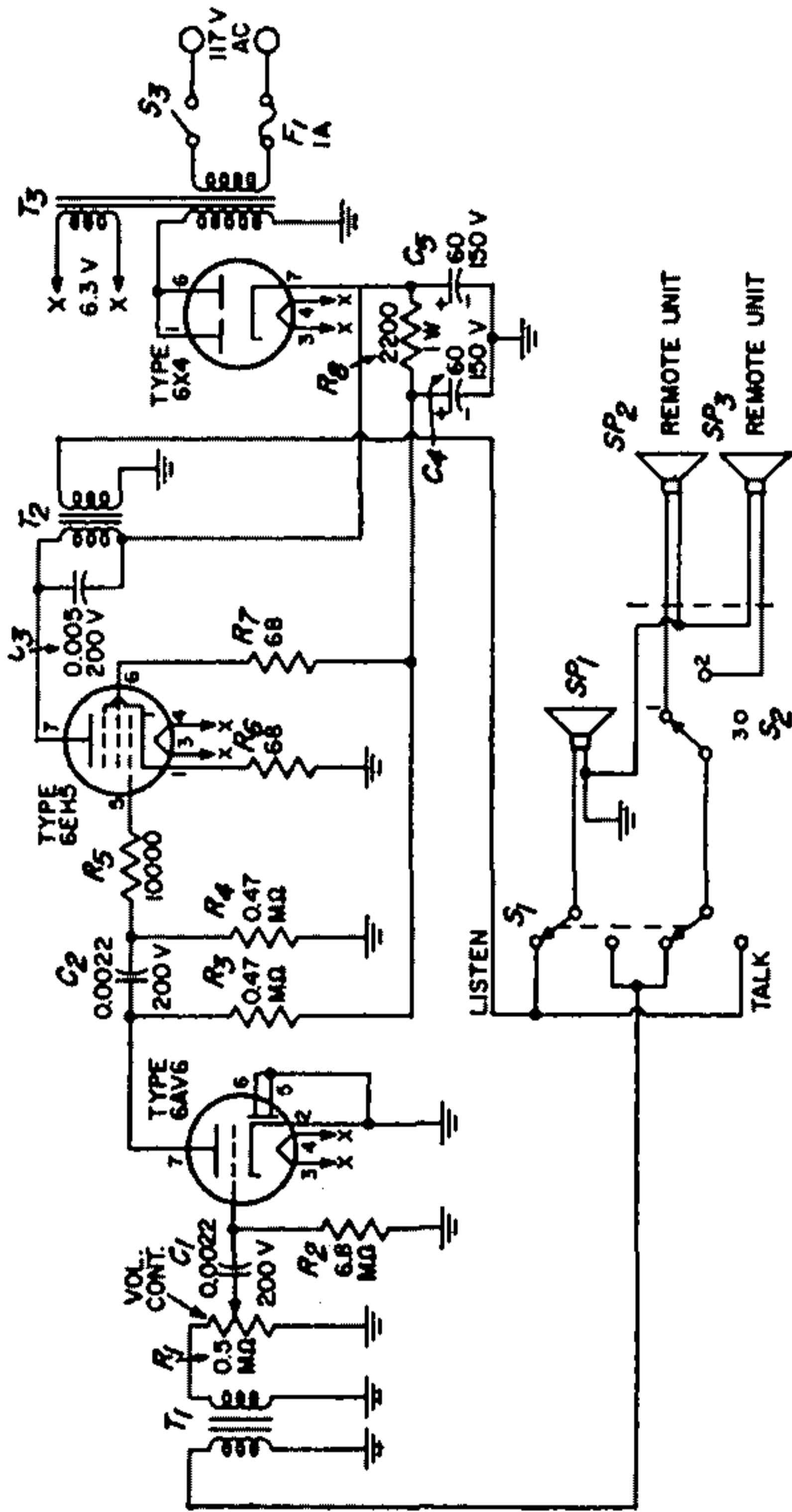
resonant frequency of the crystal. The 1650-kHz output from the converter is amplified by two if-amplifier stages. The amplifier tube in the first if amplifier is a 6BA6 remote-cutoff pentode; in the second if stage, the pentode section of a 6BE8 triode-pentode is used to provide the if-signal amplification. The double-tuned if transformers  $T_4$ ,  $T_5$ , and  $T_6$  are designed to provide optimum adjacent-channel selectivity together with sufficient bandwidth to accommodate the maximum crystal-frequency error ( $\pm 0.005$  per cent for both transmitting and receiving crystals) allowed by FCC regulations.

The output from the if amplifiers is demodulated by the 1N87G detector diode and associated components. The rectified current from the 1N87G diode also causes a negative voltage proportional to the received signal to be developed across the 5000-pico-farad capacitor in parallel with the detector filter network. This voltage is applied as agc bias to the control grid of the rf and if amplifiers and to the signal grid of the pentagrid converters. The detected audio signal voltage is coupled by crystal diode  $CR_1$  and the VOL. CONT. potentiometer to the control grid of the 6AV6 triode section used in the audio volt-

age amplifier. Diode  $CR_1$ , which is biased by the voltage from the agc line (line F) and the positive voltage from the cathode of the 6AQ5A audio power amplifier, acts as a series noise limiter, and effectively limits transient noise induced in the receiver. The output from the audio-voltage amplifier is applied to the control grid of the power amplifier, which develops the power required to drive the speaker.

The control-grid return of the audio voltage amplifier is connected to the wiper arm of the SQUELCH CONT. potentiometer. This control is part of a voltage divider between the first if-amplifier screen grid and -65-volt bias supply. The potentiometer is adjusted to just cut off the audio amplifier with no signal input. When a signal is received, the agc voltage applied to the control grid of the first if amplifier reduces the screen-grid current of this stage. The screen-grid voltage then rises and, in turn, causes the control-grid voltage of the audio amplifier to rise, and the amplifier is no longer held cut off. A clamp circuit formed by one of the diode sections of the 6AV6 and associated components prevents the grid of the triode (audio-amplifier) section of this tube from going positive.

**25-9 INTERCOMMUNICATION SET**  
 With Master Unit and Two or More Remote Units



- Notes:
1. The leads from the LISTEN-TALK switch to T<sub>1</sub> and T<sub>2</sub> should be kept as far apart as possible to prevent undesirable regenerative effects.
  2. Connections to the remote speaker units should be made with low-resistance wire, preferably with shielded "intercom" cable.
  3. Resistance in ohms and capacitance in microfarads unless otherwise specified.
  4. All resistors 0.5 watt unless otherwise specified.
  5. Potentiometer should have audio taper.

$S_1$  = Talk-listen switch, double-pole double-throw  
 $S_2$  = Station Selector, rotary switch  
 $S_3$  = On-off switch, single-pole single-throw

attached to volume control potentiometer  
 $SP_1$   $SP_2$   $SP_3$  = Speaker; permanent-magnet; voice-coil impedance, 3 to 4 ohms

$T_1$  = Input transformer, 4-ohm primary, 2500-ohm secondary  
 $T_2$  = Output transformer, 3000-ohm primary  
 $T_3$  = Power transformer; 125 volts rms, 50 mA; 6.3 volts, 2 amperes.

### Circuit Description

This simple "intercom" set can be used to achieve reliable voice communications, at normal speaking levels, between any two points in a normal-size house. The system consists of a master unit, centrally located at the hub of household activity, interconnected by low-loss cabling to remote units located at points (e.g., garage, attic, and cellar) beyond the range of normal voice levels. An audio amplifier, which includes a 6AV6 voltage-amplifier stage and a 6EH5 power-output stage, provides the amplification necessary to overcome the attenuation of voice levels by system cabling. A 6X4 half-wave rectifier circuit converts the 117-volt ac input power to the dc power required for operation of the amplifier stages. A 6.3-volt secondary winding on the power transformer ( $T_3$ ) in the rectifier circuit provides heater power for the amplifier and rectifier tubes.

The speaker at each intercom station is used for both talk and lis-

ten functions. The talk-listen switch  $S_1$  at the master location establishes the talk or listen mode for all stations. The voice communications are initiated from the master unit. Switch  $S_1$  is depressed to the TALK position, and the initiator talks into the master-unit speaker. The audio (voice-signal) voltage that is then developed across the speaker voice coil is coupled by input transformer  $T_1$  to the control grid of the 6AV6 audio amplifier. Selector switch  $S_2$  connects the desired remote unit into the intercom system. With  $S_1$  depressed to the TALK position, the remote unit speaker is automatically connected to the audio amplifier output for listen-mode operation. When  $S_1$  is in the LISTEN position, the master-unit speaker is connected in the listen mode, and the remote-unit speaker is connected to the amplifier input. A reply from the remote unit is then coupled from the remote speaker by transformer  $T_1$  to the control grid of

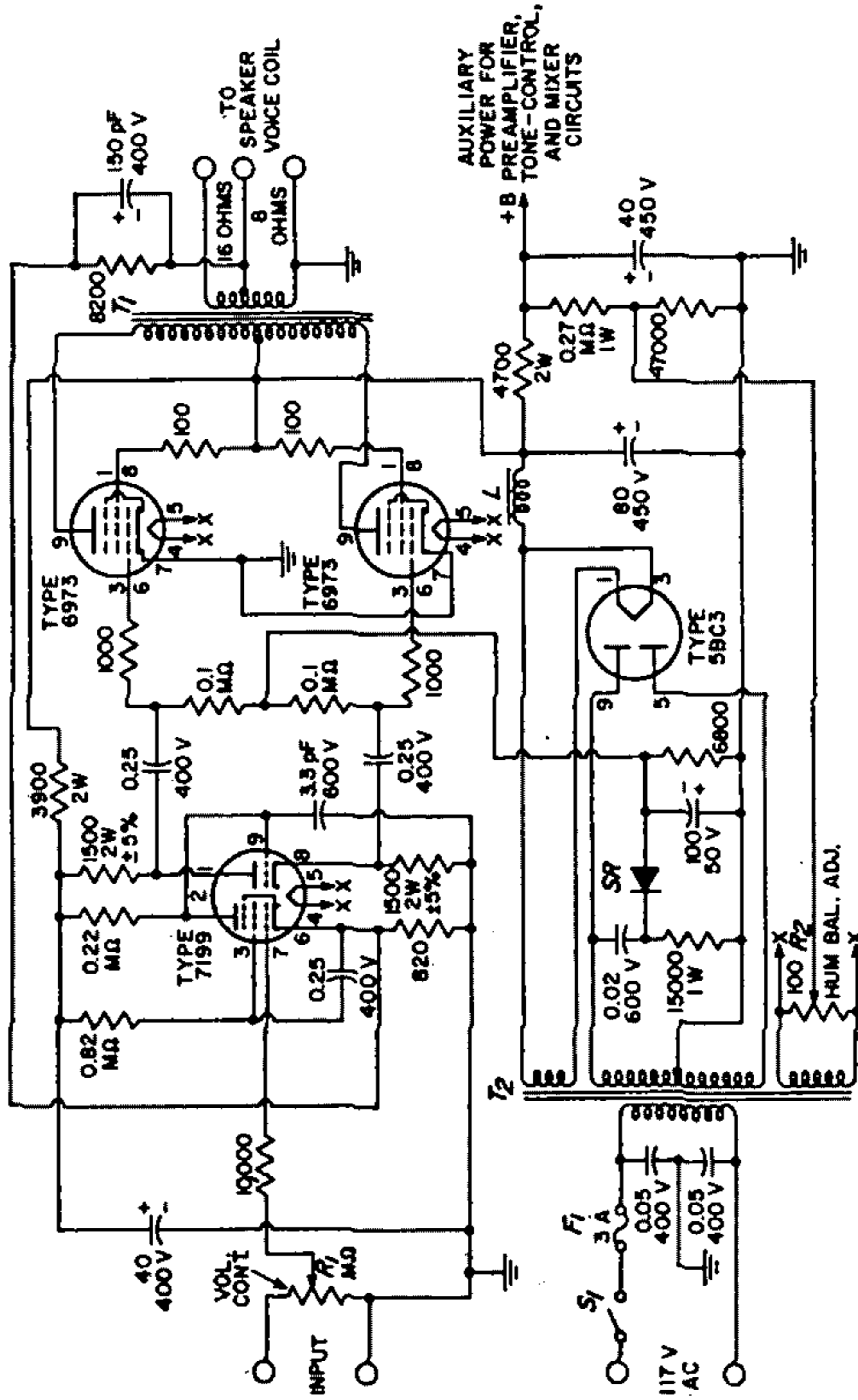
the 6AV6 audio amplifier.

Transformer  $T_1$  matches the voice-coil impedance of the 4-ohm permanent-magnet speaker (of either master or remote unit) to the 2500-ohm input impedance of the 6AV6 amplifier stage. This stage and the 6EH5 audio output stage amplify the audio (voice) signals received from one location (the master unit or one of the remote units) to develop the audio power required to produce an audible output from the speaker at another location. Output transformer  $T_2$  matches the 3000-ohm plate-circuit impedance of the output stage to the 4-ohm voice-coil impedance of the speaker (master-unit or remote-unit) to which the communication is directed, as determined by the settings of switches  $S_1$  and  $S_2$ . The VOL. CONT. potentiometer  $R_1$  in the input circuit of the 6AV6 audio amplifier stage provides the volume-control adjustment for the system.



25-10 HIGH-FIDELITY AUDIO AMPLIFIER

Class AB<sub>i</sub>; Power Output, 15 Watts





L = Filter choke; 3H; 160 mA; dc resistance, 75 ohms or less; Triad C-13X or equiv.  
 SR = Selenium rectifier, 20 mA, 135 volts rms  
 T<sub>1</sub> = Audio output transformer (has 8-

ohm tap for feedback connection); matches impedance of speaker voice coil to 6600-ohm plate-to-plate tube load; 50 watts; frequency response, 10 to 50000 Hz; Stancor A-8056 or

equiv.  
 T<sub>2</sub> = Power transformer; 360-0-360 volts rms, 120 mA; 6.3 volts, 3.5 amperes; 5 volts, 3 amperes; Stancor 8410 or equiv.

- Notes: 1. Resistance in ohms and capacitance in microfarads unless otherwise specified.  
 2. All resistors 0.5 watt  $\pm 10\%$  unless otherwise specified.  
 3. Potentiometers should have audio taper.

4. If amplifier oscillates or "motorboats," reverse ground and feedback connections in secondary of output transformer T<sub>1</sub>.

### Circuit Description

This high-fidelity audio power amplifier can deliver 15 watts of rms output power with less than 0.4 per cent total harmonic distortion and less than 1.5 per cent intermodulation distortion. The frequency response of the amplifier is flat within  $\pm 0.5$  dB from 20 Hz to 60 kHz, and the sensitivity is such that the rated output of 15 watts is obtained for an input of 1.2 volts rms. The total hum and noise, with the input shorted, is 84 dB below 15 watts. The circuit operates from a 117-volt ac power line. The transformer-coupled ac input power is converted to dc operating power for the amplifier stages by the 5BC3 full-wave rectifier. Heater power for the amplifier tubes and the rectifier are obtained from the 6.3-volt and 5-volt secondary windings,

respectively, on the rectifier power transformer (T<sub>2</sub>).

A high-gain pentode voltage amplifier is used as the input stage for the audio power amplifier. The output of this stage is direct-coupled to the control grid of a triode split-load type of phase inverter. The use of direct coupling between these stages minimizes phase shift and, consequently, increases the amount of inverse feedback that may be used without danger of low-frequency instability. A low-noise 7199 tube, which contains a high-gain pentode section and a medium-mu triode section in one envelope, fulfills the active-component requirement for both the pentode input stage and the triode phase inverter. Potentiometer R<sub>1</sub> in the input circuit of the 7199

pentode section is the volume control for the amplifier.

The plate and cathode outputs of the phase inverter, which are equal in amplitude and opposite in phase, are used to drive a pair of pentode-connected 6973 beam-power tubes used in a class AB<sub>1</sub> push-pull output stage. The 6973 output tubes are biased for class AB<sub>1</sub> operation by the fixed negative voltage applied to the control-grid circuit from the rectifier circuit. Fixed bias is used because a class AB amplifier provides highest efficiency and least distortion for this bias method.

Transformer T<sub>1</sub> couples the audio-amplifier output to the speaker. The taps on the secondary of this transformer match the plate-to-plate impedance of the output stage to the

Circuit Description (Cont'd)

voice-coil impedance of an 8- or 16-ohm speaker. Negative feedback of 19.5 dB is coupled from the secondary of the output transformer (speaker voice coil) to the cathode of the input stage to reduce distortion and to improve circuit stability.

Fixed-bias operation of the output stage requires that the power supply provide very good voltage regulation because the plate current

of the 6963 tubes varies considerably with the signal level. The conventional choke-input type of power supply used provides the required regulation. The fixed bias for the output stage is obtained from one-half the high-voltage secondary winding of power transformer  $T_2$  through a capacitance-resistance voltage divider and the 20-milliamperes, 135-volt selenium rectifier. Potentiometer  $R_2$

connected across the 6.3-volt secondary winding of transformer  $T_2$  provides a hum balance adjustment for the audio power amplifier. The wiper arm of this potentiometer is connected to the junction of a resistive voltage divider across the output of the power supply. The resulting positive bias voltage applied to the tube heaters minimizes heater-to-cathode leakage and substantially reduces hum.

25-11 HIGH-FIDELITY AUDIO AMPLIFIER

Class AB<sub>1</sub>; Power Output, 30 Watts

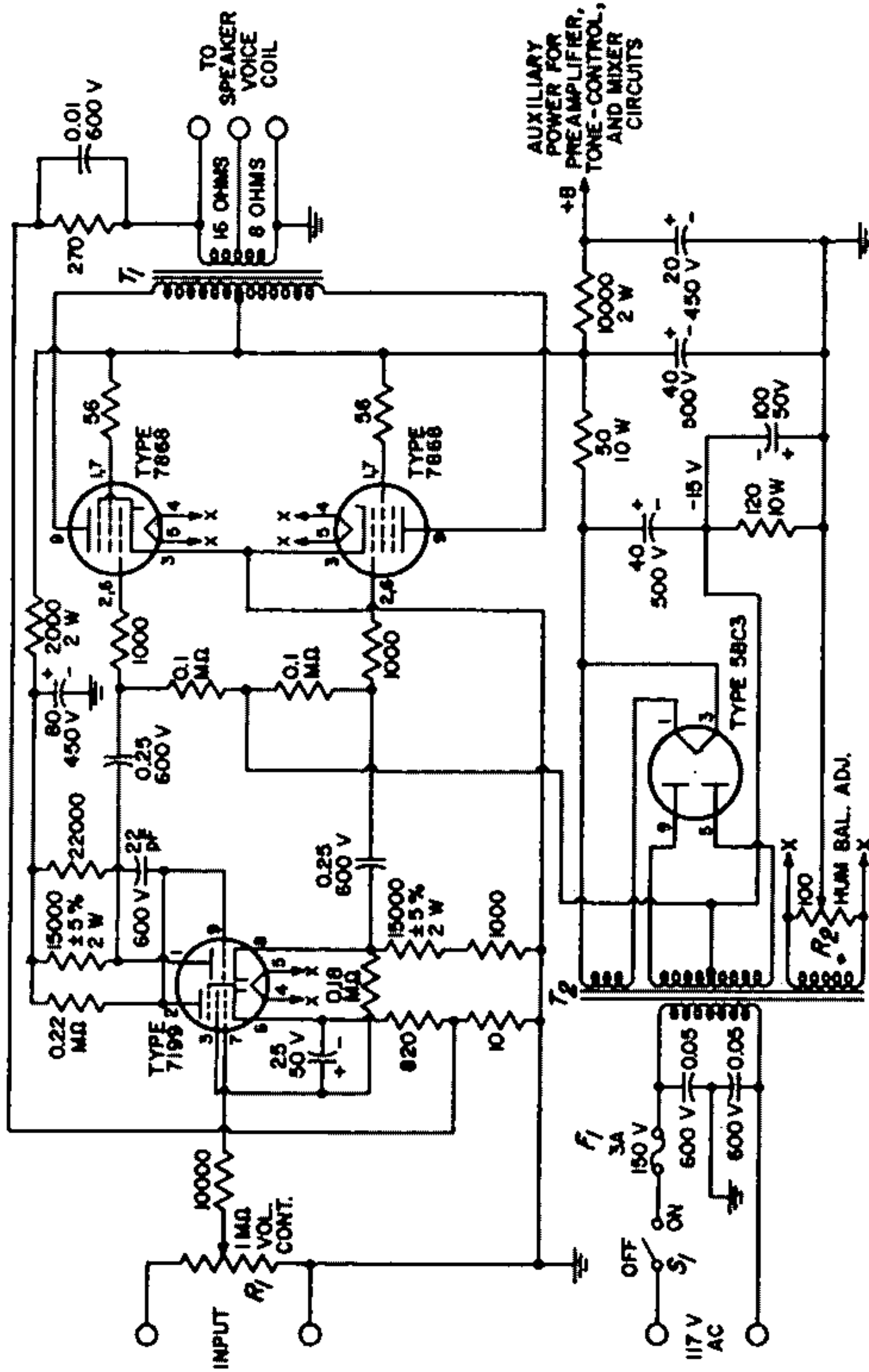
This audio power amplifier can deliver 30 watts of rms output power with less than 0.7 per cent total harmonic distortion and less than 1.5 per cent intermodulation distortion. The frequency response of the amplifier is flat within  $\pm 0.5$  dB from 15 Hz to 40 kHz. The total hum and noise, with the input shorted, is 85 dB below 30 watts. The rated output of 30 watts is obtained for an input of 1 volt rms.

The 30-watt amplifier is essen-

tially identical to the 15-watt amplifier (circuit 25-10) except that it uses 7027A beam power tubes in the output stage to develop the higher audio power output and uses a resistive network in the negative leg of the power supply, rather than a separate rectifier, to supply the fixed-bias voltage for the output stage. A potentiometer ( $R_2$ ) connected across the 6.3-volt heater winding also provides the hum balance adjustment for the 30-watt amplifier.

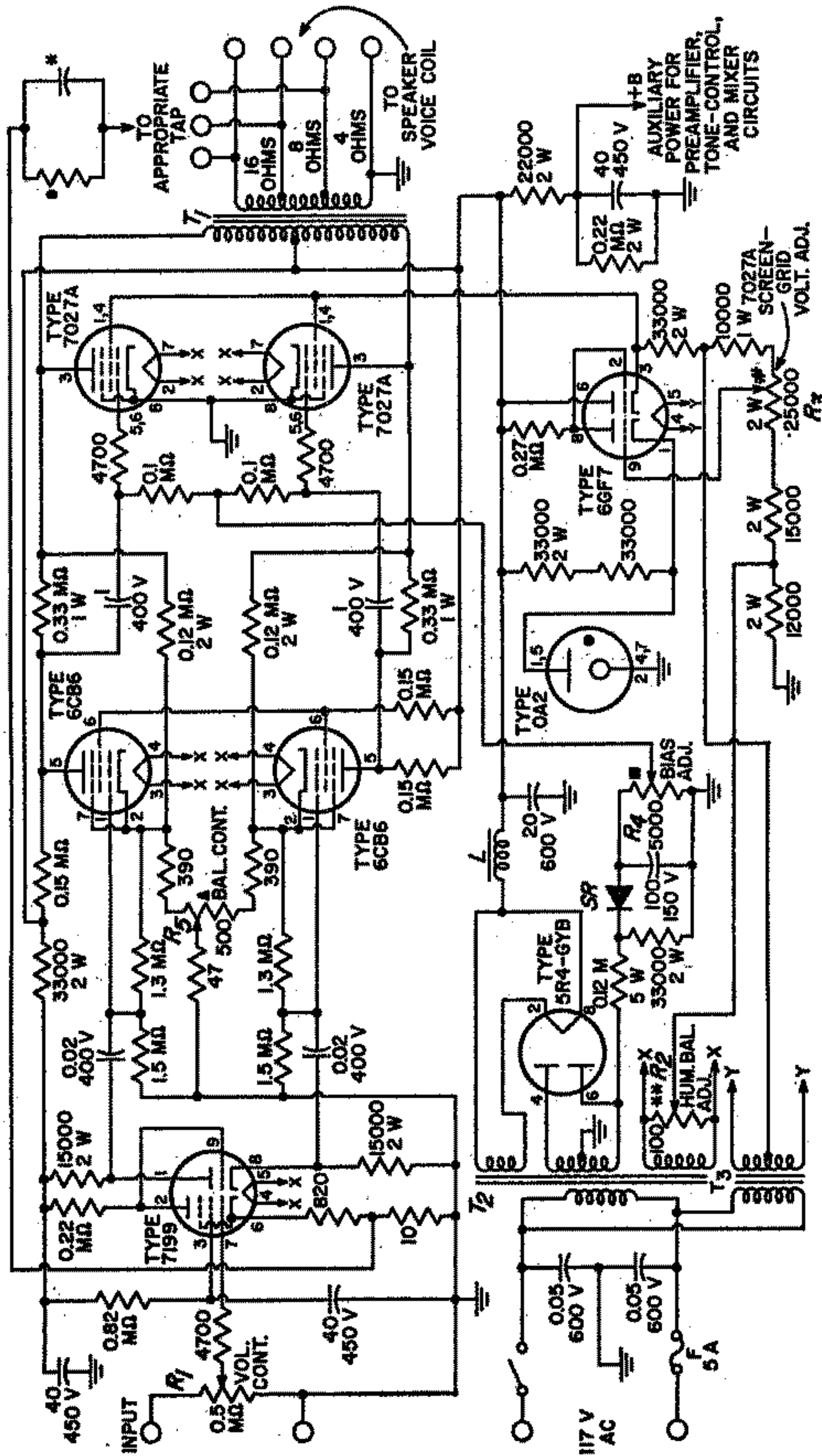
$T_1$  = Audio output transformer (has 16-ohms tap for feedback connection); matches impedance of speaker voice coil to 6600-ohm plate-to-plate tube load; 50 watts; frequency response, 10 to 50000 Hz; Stancor A-8056 or equiv.  
 $T_2$  = Power Transformer; 375-0-375 volts rms, 160 mA; 6.3 volts, 5 amperes; 5 volts, 3 amperes, Thordarson T22R33 or equiv.

25-11 HIGH-FIDELITY AUDIO AMPLIFIER (Cont'd)



- Notes:
1. Resistance in ohms and capacitance in microfarads unless otherwise specified.
  2. All resistors 0.5 watt,  $\pm 10\%$  unless otherwise specified.
  3. Potentiometers should have audio taper.
  4. If amplifier oscillates or "motor-boats," reverse ground and feedback connections in secondary of output transformer T<sub>1</sub>.

25-12 HIGH-FIDELITY AUDIO AMPLIFIER Class AB<sub>1</sub>; Power Output, 50 watts



- Notes:
1. Resistance in ohms and capacitance in microfarads unless otherwise specified.
  2. All resistors 0.5 watt, ±10% unless otherwise specified.
  3. Potentiometers should have audio taper.
  4. If amplifier oscillates or "motorboats," reverse ground and feedback connections in secondary of output transformer T<sub>1</sub>.



## 25-12 HIGH-FIDELITY AUDIO AMPLIFIER (Cont'd)

- \* Capacitor = 0.002  $\mu$ F when connected to 4-ohm transformer tap, 0.0015  $\mu$ F when connected to 8-ohm tap, or 0.001  $\mu$ F when connected to 16-ohm tap, 400 volts.
- Resistor = 600 ohms when connected to 4-ohm transformer tap, 820 ohms when connected to 8-ohm tap, or 1200 ohms when connected to 16-ohm tap, 0.5 watt.

### Preliminary Adjustments

The following adjustments should be made before operation:

- (\*) With rectifier out of socket, adjust Bias Adj. for —40 volts between the wiper arm and ground bus.
- (#) With speaker connected, adjust Screen-Grid Voltage Adj. for 400 volts between pin 3 of 6GF7 and ground bus.
- (\*\*) With input shorted, adjust Hum Bal. Adj. for minimum hum from speaker.
- (^) With input open and Vol. Cont. set for maximum volume, adjust Bal. Cont. for minimum hum from speaker.

### Circuit Description

This four-stage audio power amplifier can deliver 50 watts of rms power output with less than 0.1 per cent total harmonic distortion and less than 1 per cent intermodulation distortion. The frequency response of the amplifier is flat within  $\pm 0.5$  db from 10 Hz to 50 kHz. Sensitivity is 0.4 volt rms input for 50 watts output. The total hum and noise is 70 db below 50 watts.

The 50-watt amplifier, like the 15-watt and 30-watt high-fidelity amplifiers (circuits 25-10 and 25-11), uses a 7199 low-noise triode-pentode

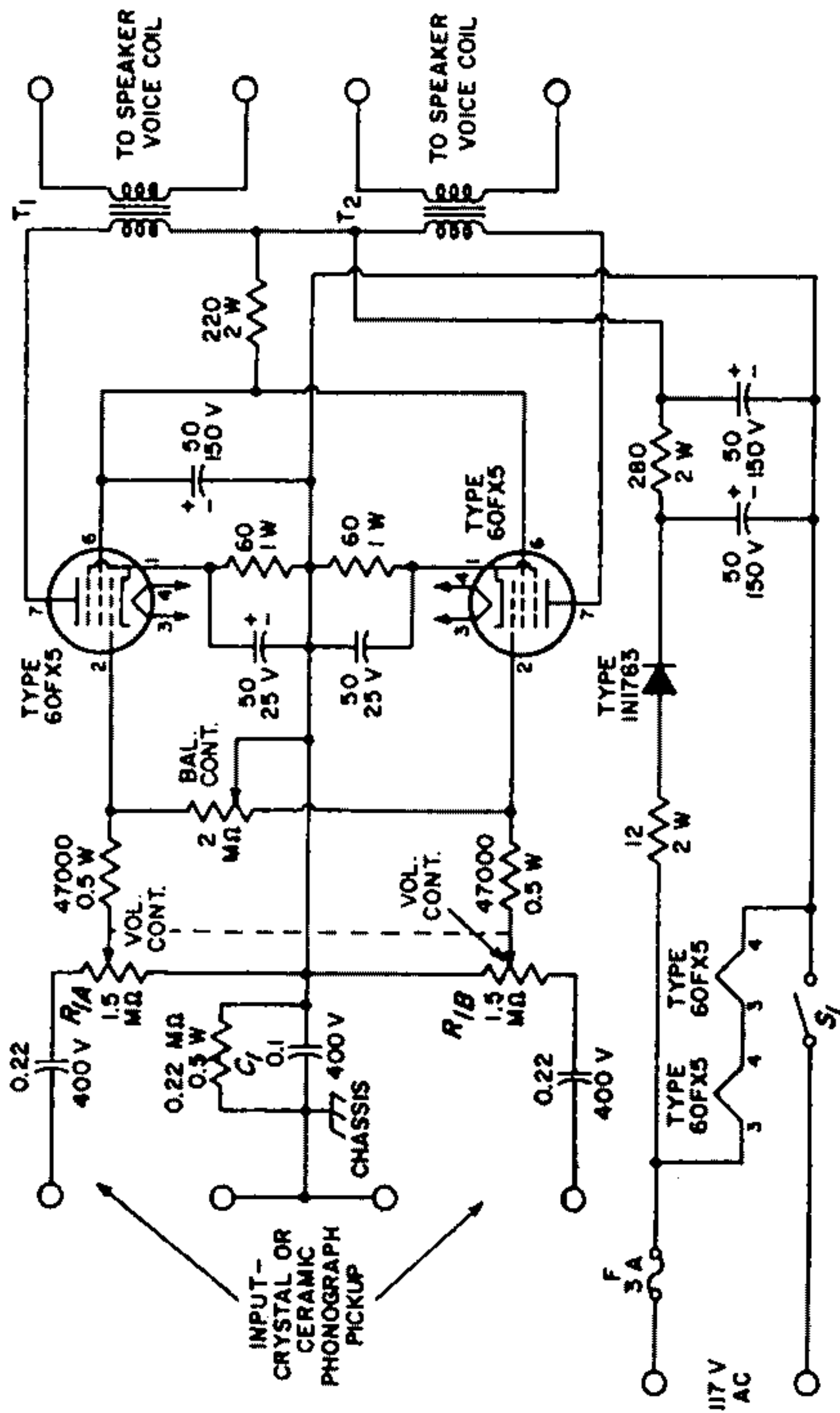
as an input amplifier and phase-splitter, but has a push-pull driver stage, which uses 6CB6 sharp-cutoff pentodes. The superior performance of this amplifier can also be attributed, in part, to the use of a 450-volt plate supply and a 400-volt electronically regulated grid-No. 2 supply for the 7027A beam power tubes in the output stage and to the use of inverse-feedback loops from the plates to the grids of the output tubes, from the plates to the output tubes to the cathodes of the driver tubes, and from the voice-coil winding of the

output transformer to the cathode of the input amplifier. Additional features are the operation of all heaters at a positive voltage with respect to ground and use of a balancing adjustment ( $R_2$ ) in the heater-supply circuit to minimize hum, a grid-No. 2 voltage adjustment ( $R_3$ ), a grid-No. 1 bias adjustment ( $R_1$ ) for the 7027A output tubes, and an ac-balance adjustment ( $R_4$ ) which may be used to balance the outputs of the push-pull stages. Operation of the 50-watt amplifier is essentially the same as that of the 15- and 30-watt amplifiers.

- L = Filter choke; 8H; 250 mA; dc resistance, 60 ohms or less
- SR = Selenium rectifier, 20 mA, 135 volts rms
- T<sub>1</sub> = Audio output transformer; matches impedance of speaker voice coil to 5000-ohm plate-to-plate tube load; 50 watts; frequency response, 10 to 50000 Hz; Acrosound T0340 or equiv.
- T<sub>2</sub> = Power transformer; 600-0-600 volts rms, 200 mA; 6.3 volts, 5 amperes; 5 volts, 3 amperes; Thordarson 22R36 or equiv.
- T<sub>3</sub> = Filament transformer; 6.3 volts, center-tapped, 1 ampere; Thordarson 21F08 or equiv.

**25-13 TWO-CHANNEL STEREOPHONIC AMPLIFIER**

Power Output, 1 Watt Each Channel



T<sub>1</sub> T<sub>2</sub> = Audio output transformer, matches impedance of speaker voice coil to 3000-ohm tube plate load, Triad S-16X or equiv.

Notes: 1. Resistance in ohms and capacitance in microfarads unless otherwise specified.  
2. Potentiometers should have audio taper.

### Circuit Description

This ac/dc two-channel (stereo) amplifier operates from either an ac power line or dc supply of 117 volts. AC power inputs are converted to dc power by the 1N1768 silicon-diode half-wave rectifier circuit. The heaters of the 60FX5 power pentodes (one for each channel) used in the amplifier are connected in series directly across the input power line.

In stereo units that use high-output ceramic stereo cartridges, the high power sensitivity of the 60FX5 tubes at low supply voltage eliminates the need for preamplifier stages. The 60FX5 provides a power

output of 1.3 watts to a 3000-ohm transformer primary with only 3 volts peak drive on grid No. 1. With a transformer having a good impedance match and 85-percent efficiency, each channel of the stereo amplifier supplies 1.1 watts of useful power output at the speaker.

No special mounting or layout precautions are necessary for this amplifier other than the value and placement of the isolating capacitor C<sub>1</sub> between B- and the chassis. This capacitor should be connected to the same point on the chassis at which the common cartridge lead is tied.

A value of 0.1 microfarad for the isolating capacitor is suggested so that full output is obtained from the pickup.

As with all single-ended amplifier circuits, especially ac/dc units, adequate screen-grid bypassing is necessary to minimize hum. Screen-grid filtering is obtained through use of a 220-ohm dropping resistor and a 50-microfarad electrolytic capacitor. Although, in the circuit shown, separate cathode-bias resistors are used for better dynamic balance, a single 30-ohm common cathode-bias resistor bypassed with a 50-microfarad electrolytic capacitor may also be used.





## 25-14 MICROPHONE AND PHONOGRAPH AMPLIFIER

**J<sub>1</sub>** = Jack for high-impedance crystal microphone input  
**J<sub>2</sub>** = Jack for crystal phono-pickup input  
**L** = Filter choke, 5 henries, 200 mA, Universal Transformer Corp. R20 or equiv.

**S<sub>1</sub>** = Microphone-phonograph selector; wafer switch; single-pole, double-throw  
**S<sub>2</sub>** = On-off switch; single-pole, single-throw  
**T<sub>1</sub>** = Power transformer; 300-0-300 volts rms, 90 mA; 6.3 volts, 3.5 amperes, center-tapped; 5 volts, 2 amperes;

Thordarson 22R04 or equiv.  
**T<sub>2</sub>** = Universal audio output transformer, matches impedance of speaker voice coil to 4000-ohm tube plate load, 10 watts, Universal Transformer Corp. S14 or equiv.

### Circuit Description

This microphone and phonograph amplifier can deliver up to 8 watts of audio output power for an input of 200 millivolts rms at **J<sub>2</sub>** (phonograph input) or an input of 6.8 millivolts rms at **J<sub>1</sub>** (microphone input). The amplifier uses a 6EU7 twin-triode input amplifier, a 6AV6 driver stage, and a 6L6GC single-ended output stage to increase the signal power from a high-impedance crystal microphone or crystal phonograph pickup to the desired level. The transformer-coupled ac input power is converted to dc operating power for these stages by a 5Y3GT full-wave rectifier circuit. A 5-volt winding on power transformer **T<sub>1</sub>** provides the heater power for the rectifier tube, and a 6.3-volt winding provides heater power for the other tubes in the amplifier. The center tap on the

6.3-volt winding is connected to the junction of a resistive voltage divider across the output of the power supply. The resulting positive bias applied to the tube heaters substantially reduces heater-to-cathode leakage and, consequently, minimizes hum.

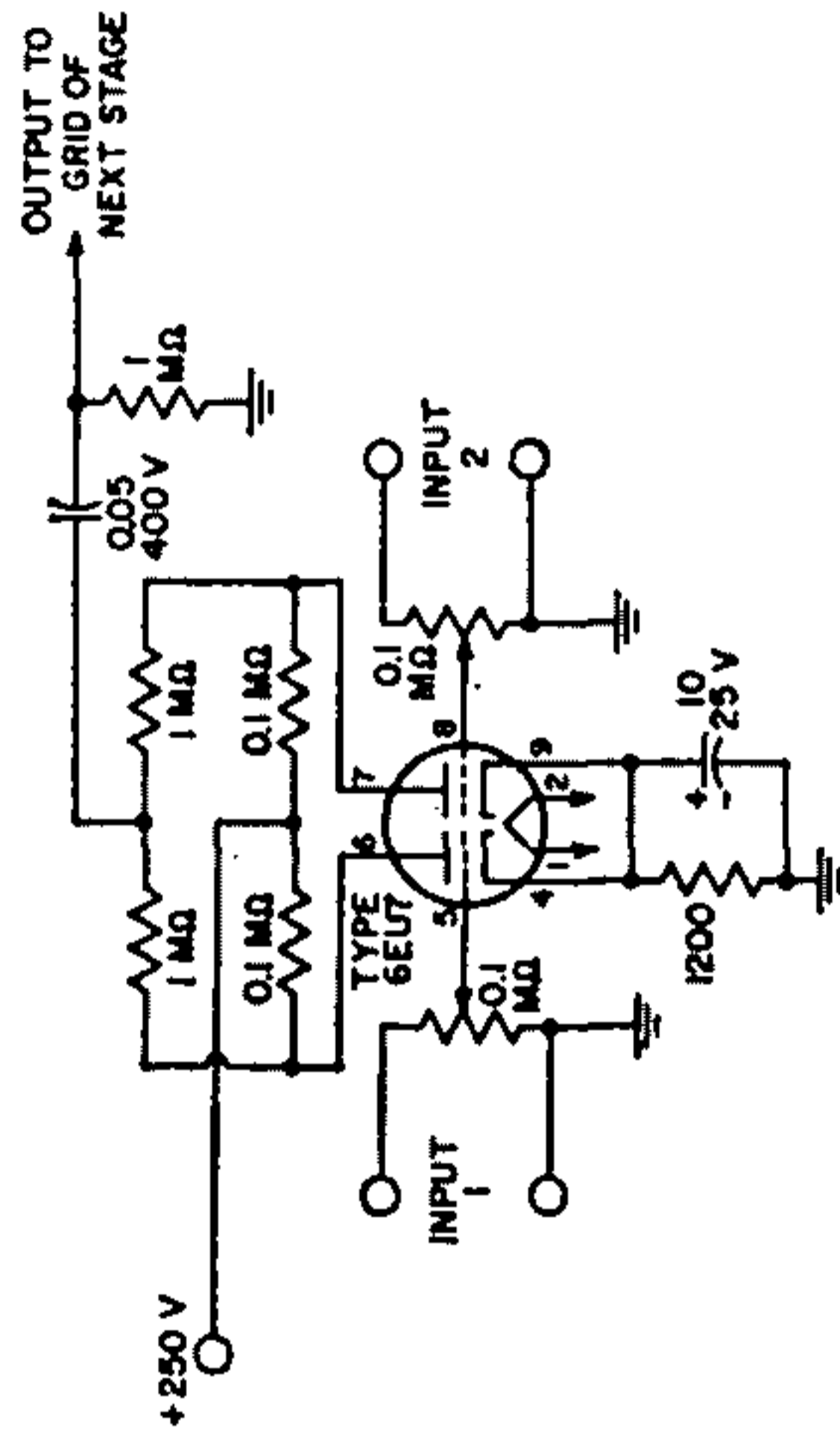
The signals from a crystal microphone are usually much smaller than those from a crystal phonograph pickup. Microphone signals, therefore, are amplified by both sections of the 6EU7 twin-triode amplifier. The signals are coupled from **J<sub>1</sub>** to the pin 5 control grid of the 6EU7. The plate output from this triode section is then coupled through switch **S<sub>1</sub>** (microphone position) and volume-control potentiometer **R<sub>1</sub>** to the pin 8 control grid of the 6EU7. With selector switch **S<sub>1</sub>** in the phonograph position, phonograph inputs

are coupled directly from **J<sub>2</sub>** across volume-control potentiometer **R<sub>1</sub>** to the pin 8 control grid, and the first section of the 6EU7 is bypassed.

The outputs from the pin 7 plate of the 6EU7 are coupled across the frequency-sensitive tone-control network to the control grid of the 6AV6 driver stage. The bass and treble controls **R<sub>2</sub>** and **R<sub>3</sub>** are adjusted to assure optimum low- and high-frequency response characteristics for the amplifier. The two diode plate sections of the 6AV6 are shorted to the tube cathode and thereby are made inoperative. The output of the driver stage is applied to the 6L6GC output stage which develops the audio power required to drive a speaker. Transformer **T<sub>2</sub>** matches the 4000-ohm plate impedance of the output stage to the speaker voice-coil impedance.

**25-15 TWO-CHANNEL AUDIO MIXER**

Voltage Gain from Each Grid of 6EU7 to Output is Approximately 20



- Notes: 1. Resistance in ohms and capacitance in microfarads unless otherwise specified.  
 2. All resistors 0.5 watt unless otherwise specified.  
 3. Potentiometers should have 10% taper.

**Circuit Description**

This high-fidelity mixer circuit can be used to combine audio-frequency program material from two sources. Each signal channel consists of a one-stage voltage amplifier

using one section of a 6EU7 low-noise twin-triode. Each section of the mixer can provide a voltage gain of about 20, and can handle an input signal of about 0.2 volt rms without

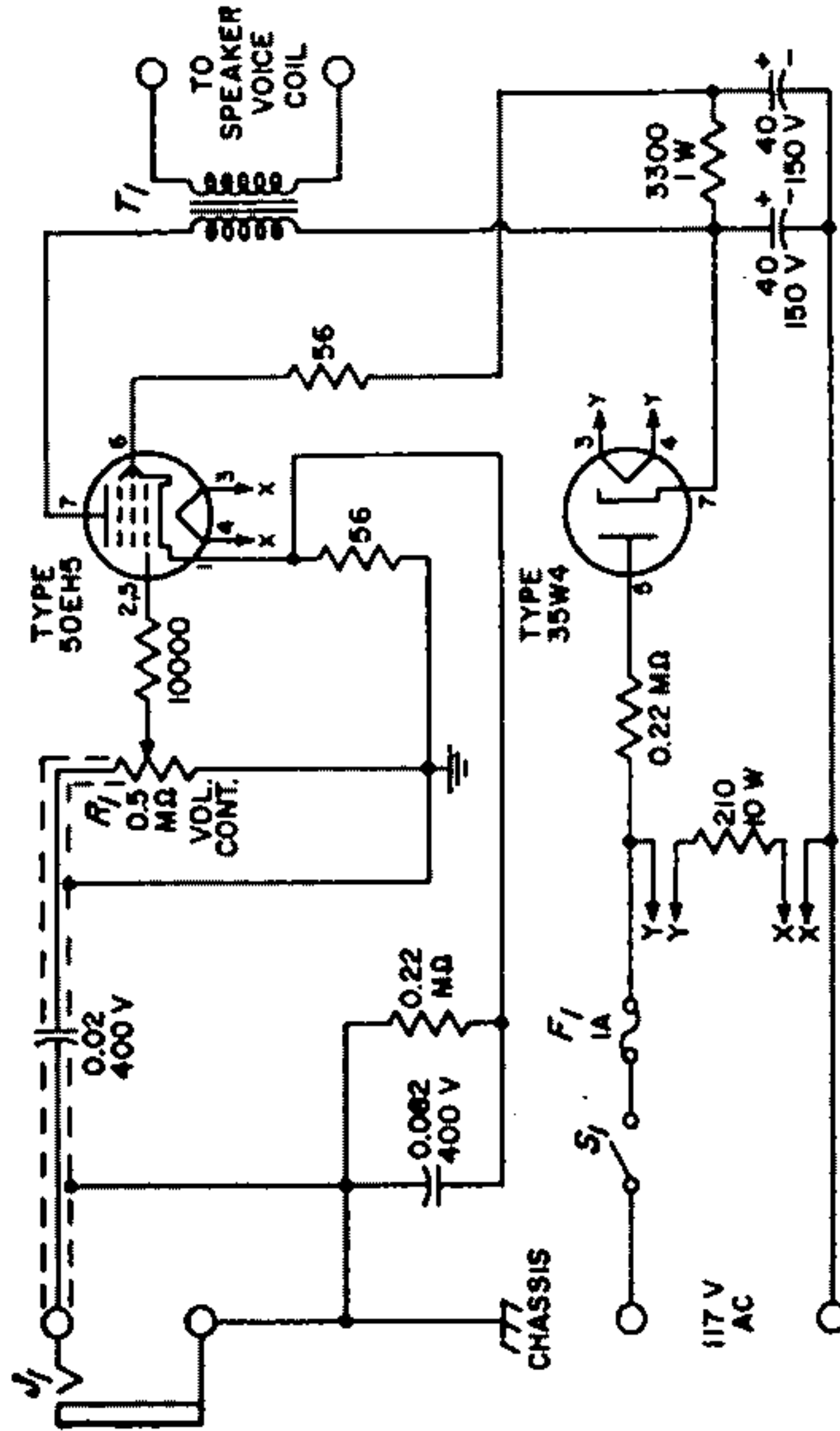
overloading. The dc plate supply of +250 volts (nominal value) for the mixer stages can usually be obtained from an auxiliary tap on the power supply for the audio power amplifiers.

**25-16 PHONOGRAPH AMPLIFIER**  
Power Output, 1 Watt

**Circuit Description**

This single-stage phonograph amplifier operates directly from either an ac power line or a dc supply of 117 volts. AC power inputs are converted to dc power by the 35W4 half-wave rectifier circuit. The heaters of the amplifier and rectifier tube are connected in series, together with a 210-ohm voltage-dropping resistor, directly across the input power line.

The amplifier uses a 50EH5 power pentode to develop up to 1 watt of audio output power from the input supplied from a crystal phonograph pickup. The input is applied at J<sub>1</sub> and coupled through a length of shielded cable to the input circuit of the pentode amplifier. Volume-control adjustment for the amplifier is provided by potentiometer R<sub>1</sub>. The output coupling transformer T<sub>1</sub> matches the 3000-ohm plate load impedance of the 50EH5 to the voice-coil impedance of the speaker.

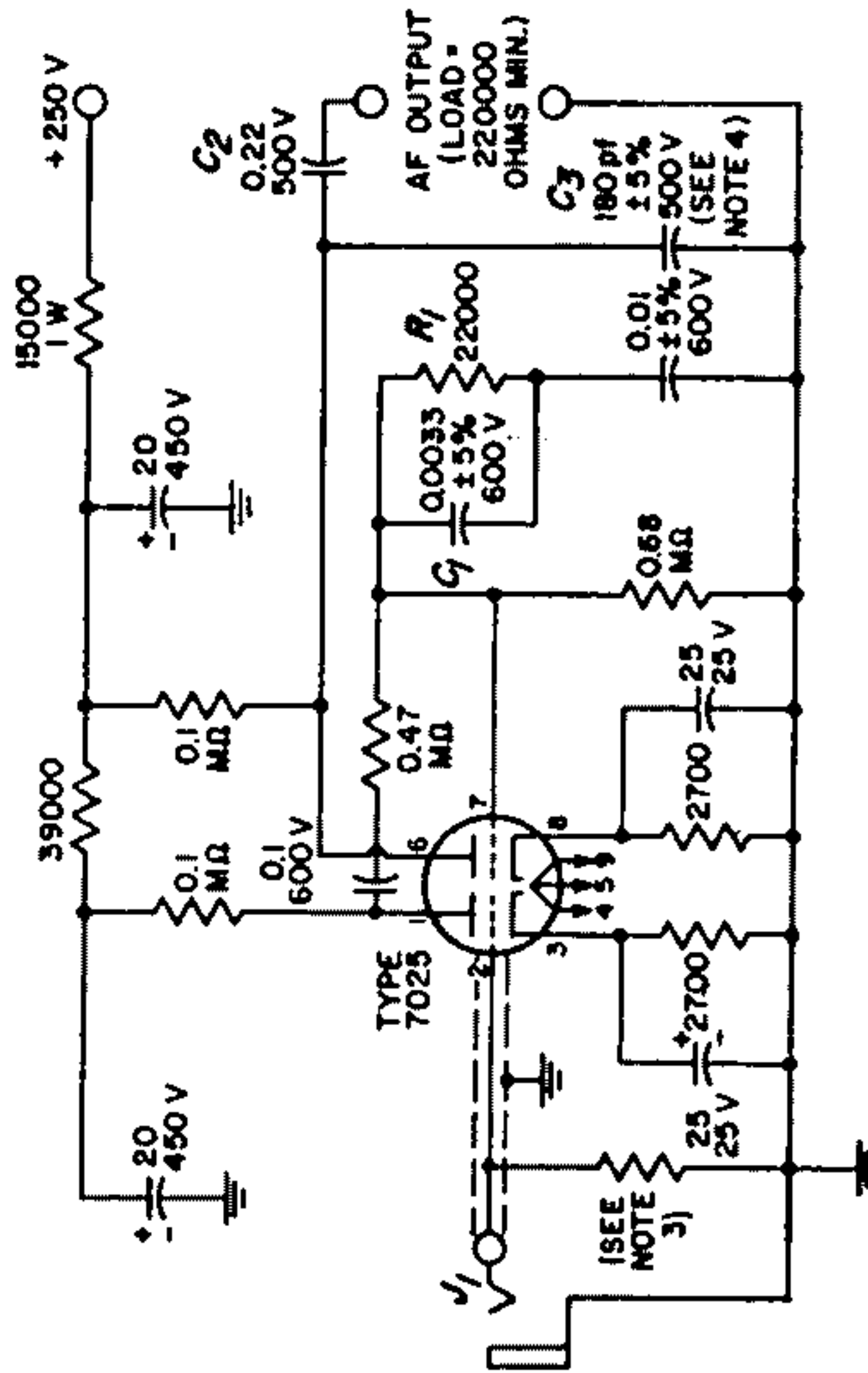


J = Input connector, shielded, for crystal phonograph pickup  
T = Audio output transformer, matches impedance of speaker voice coil to 3000-ohm tube load

Notes: 1. Resistance in ohms and capacitance in microfarads unless otherwise specified.  
2. All resistors 0.5 watt unless otherwise specified.  
3. Potentiometers should have audio taper.

25-17 PREAMPLIFIER FOR MAGNETIC PHONOGRAPH PICKUP

With RIAA Equalization



J = Input connector, shielded, for high-impedance magnetic phono pickup (10 mV output approx.)

Sensitivity = 3 millivolts rms input for output of 0.55 volt at frequency of 1000 c/s

Notes: 1. Resistance in ohms and capacitance in microfarads unless otherwise specified.  
 2. All resistors 0.5 watt, ±10% unless otherwise specified.  
 3. Value of input resistor depends on type of magnetic pickup used. Follow pickup manufacturer's recommendations.  
 4. Value shown for capacitor C<sub>3</sub> includes capacitance of amplifier output cable.



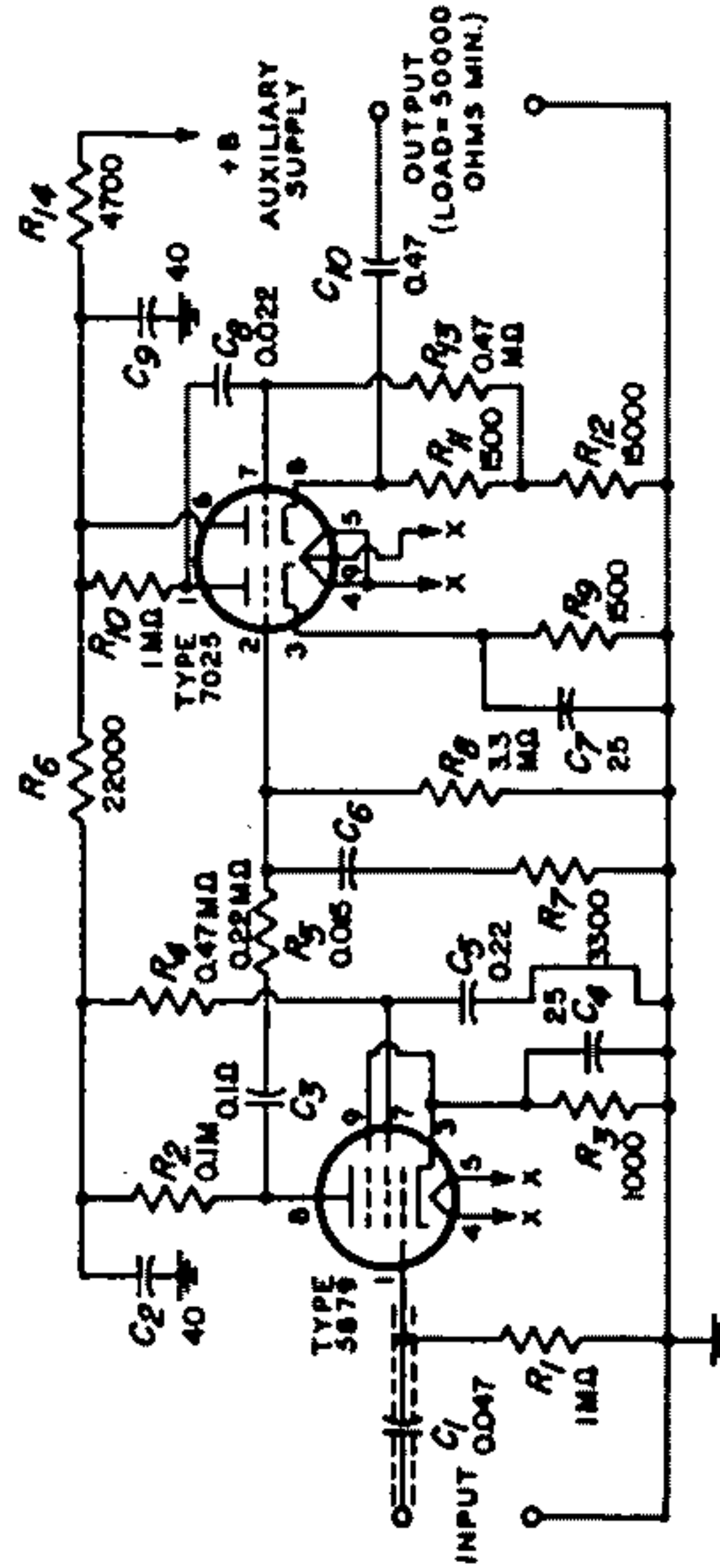
This two-stage audio preamplifier is intended for use with high-fidelity magnetic phonograph pickups. The two amplifier stages provide an overall circuit gain of approximately 150. The 7025 twin triode used in the circuit features exceptionally low hum and noise and is designed especially for use in high-fidelity circuits that operate at low signal levels. The preamplifier is ideally suited for use as the low-level input stage for audio power amplifiers such as the 50-watt unit, circuit 25-12. For use with audio power amplifiers such as the 15- and 30-watt units, circuits 25-10 and 25-11, which require higher input signals, another low-level amplifier (e.g., the tone-control amplifier, circuit 25-21) must be inserted between the preamplifier and the power amplifier to obtain the full rated output. The heater and dc operating power required for the preamplifier can usually be obtained from the power-supply circuit for the power amplifier.

The audio signal from the phonograph pickup is applied to  $J_1$  and coupled through a length of shielded cable to the control grid of the input stage of the preamplifier. The interstage coupling between the two amplifier sections of the preamplifier includes an RIAA equalization network ( $R_1$  and  $C_1$ ). This network compensates for the Orthophonic recording characteristic\* introduced into a record disc by the manufacturer. The output from the preamplifier is coupled from the plate of the second stage by output coupling capacitor  $C_2$  to the input of a tone-control amplifier (if used) or directly to the input of the power amplifier. Because of its relatively high output impedance, the preamplifier is recommended for use in systems in which the preamplifier is mounted on the same chassis as the power amplifier and/or tone-control amplifier. The preamplifier may be used at distances up to 6 feet from the following amplifier provided that the capacitance

of capacitor  $C_2$  is reduced approximately 30 picofarads for each foot of shielded cable used for the audio-frequency connection between the preamplifier and the following amplifier.

\* To achieve wide frequency and dynamic ranges, manufacturers of commercial recordings use equipment which introduces a non-uniform relationship between amplitude and frequency. This relationship is known as a "recording characteristic." To assure proper reproduction of a high-fidelity recording, therefore, some part of the reproducing system must have a frequency-response characteristic which is the inverse of the recording characteristic. Most manufacturers of high-fidelity recordings use the RCA "New Orthophonic" (RIAA) characteristic for discs and the NARTB characteristic for magnetic tape.

HIGH-FIDELITY PREAMPLIFIER FOR TAPE-HEAD PICKUP



Sensitivity = 3 millivolts rms input for output of 0.55 volt at frequency of 1000 Hz.  
 Notes: 1. Resistance in ohms and capacitance in microfarads unless otherwise specified.  
 2. All resistors 0.5 watt, ±10%, and all capacitors 400 volts unless otherwise specified.

**Circuit Description**

This three-stage preamplifier provides the amplification necessary to increase the output from a tape-head pickup to the level required to drive an audio power amplifier. The circuit uses a 5879 low-noise sharp-cutoff pentode in a high-gain input voltage amplifier, one section of a 7025 twin triode in a second voltage amplifier, and the other section of the 7025 in a cathode-follower output stage. Because of the low-impedance cathode-follower output circuit, the preamplifier may be installed at distances up to 50 feet from the following stage (tone-control or power amplifier) without adverse effect

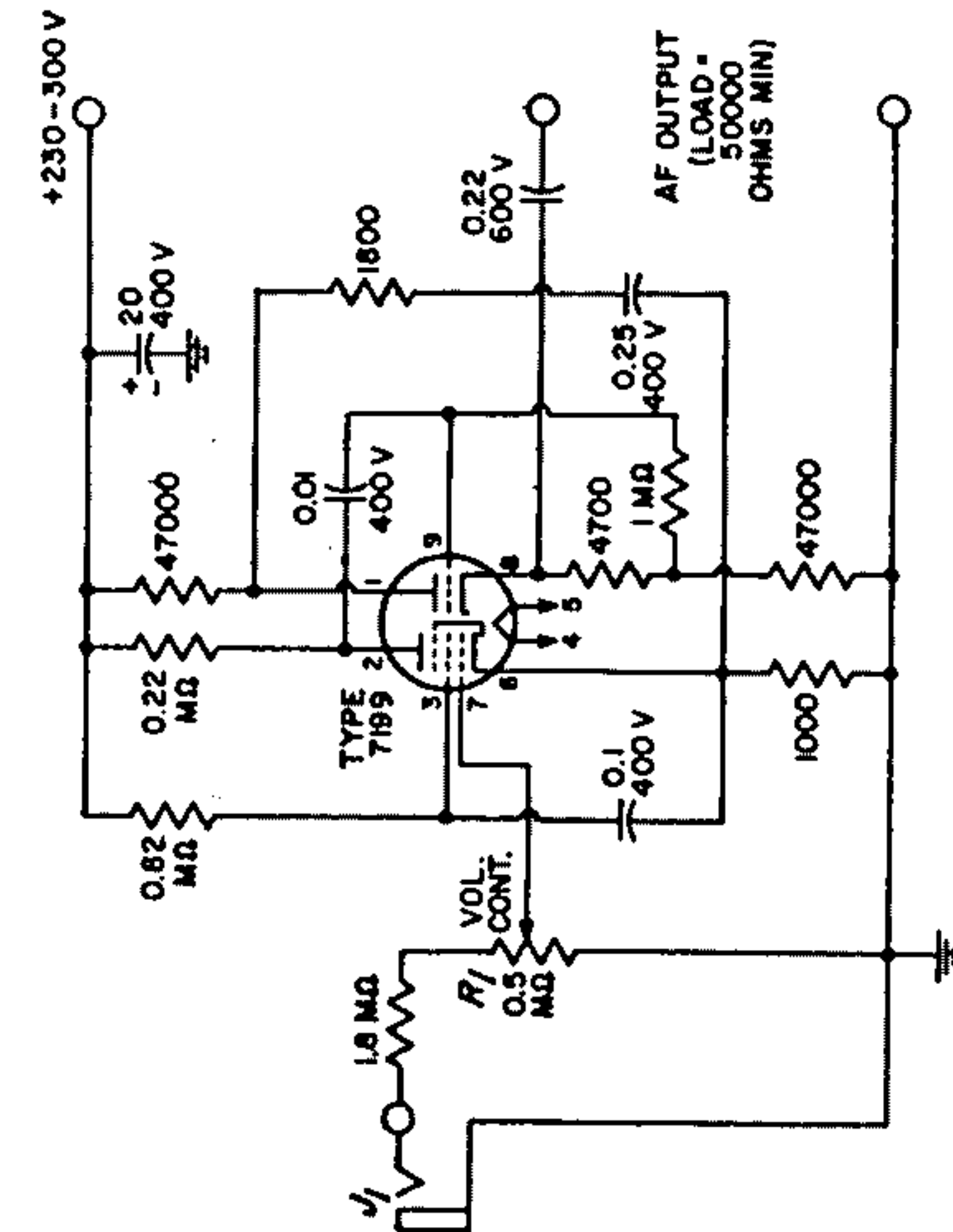
upon its frequency-response characteristics. The preamplifier is intended for use as the low-level input stages for an audio power amplifier, such as the 50-watt unit (circuit 25-12) or, when followed by another low-level amplifier (e.g., the tone-control amplifier, circuit 25-21), the 15- or 30-watt unit (circuit 25-10 or 25-11). The heater and dc operating power for the preamplifier can usually be obtained from the power supply for the power amplifier.

The preamplifier provides an over-all circuit gain of 180. An input of 3 millivolts rms at the input terminals, is amplified by the pentode

and triode voltage amplifiers to develop an output of approximately 0.55 volts rms at the cathode of the cathode-follower output stage. The interstage coupling between the pentode and triode voltage amplifiers equalizes the playback frequency response of the preamplifier to compensate for the NARTB recording characteristic introduced into the magnetic tape by the manufacturer. (See footnote for circuit 25-17.) The output of the preamplifier is coupled by capacitor  $C_{70}$  to the input of the audio power amplifier or to the input of an intermediate tone-control amplifier.

# PREAMPLIFIER FOR CERAMIC PHONOGRAPH PICKUP

Cathode Follower (Low-Impedance) Output



J = Input connector, shielded, for high-impedance ceramic phono pickup (0.5 volt output)

- Notes:
1. Resistance in ohms and capacitance in microfarads unless otherwise specified.
  2. All resistors 0.5 watt unless otherwise specified.
  3. Potentiometer should have audio taper.

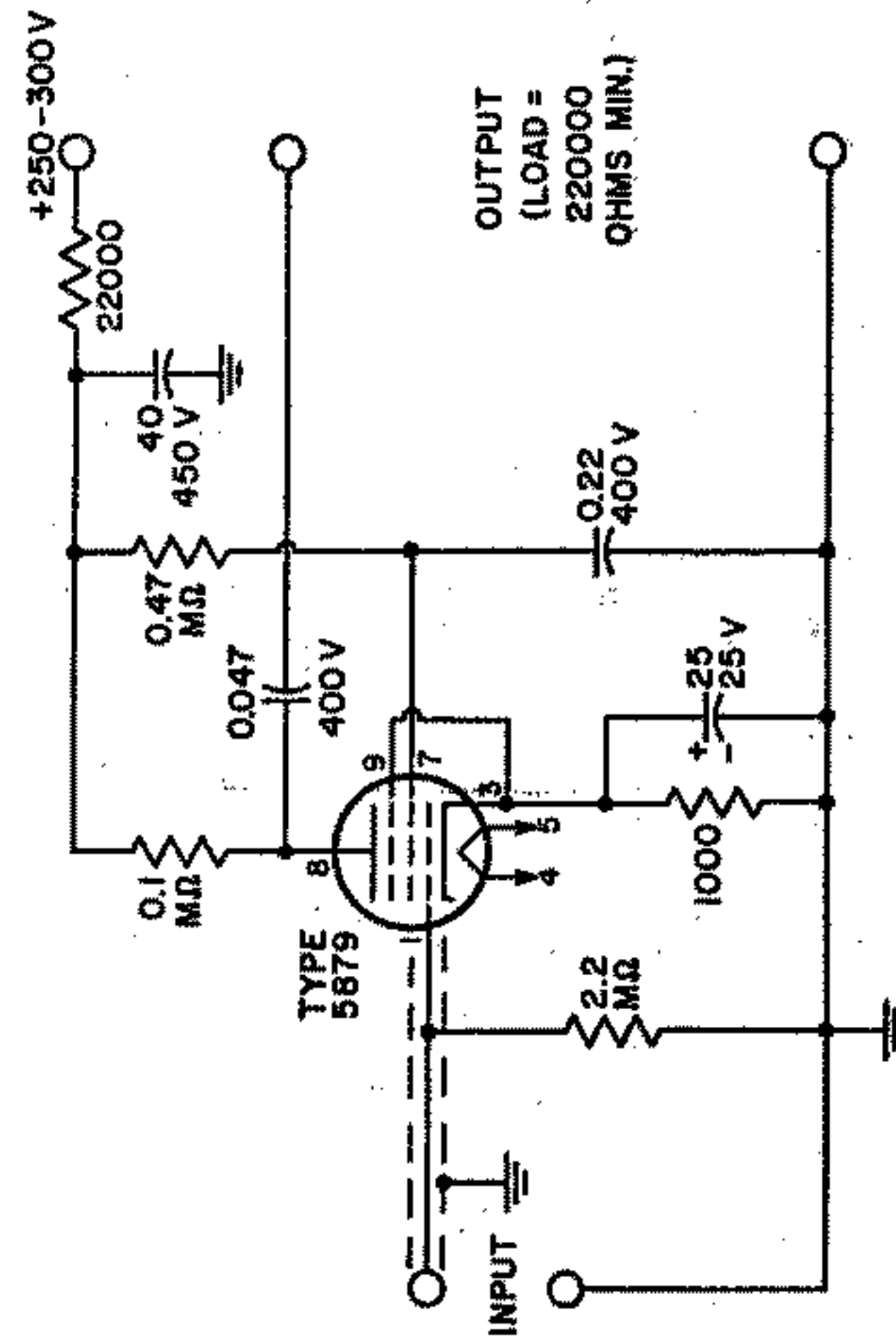
## Circuit Description

This two-stage preamplifier is intended for use with a high-impedance ceramic phonograph pickup. The circuit features a cathode-follower (low-impedance) output which makes it possible to install the preamplifier at distances up to 50 feet from the succeeding stage (tone-control or power amplifier). The preamplifier operates from a dc supply of 230 to 300 volts and a heater supply of 6.3 volts. These voltages can usually be obtained from the power supply for the power amplifier in the audio system.

The preamplifier uses a 7199 triode-pentode in a high-gain pentode input stage and a triode cathode-follower output stage. These stages provide the amplification necessary to increase the output from a crystal phonograph pickup, applied at J<sub>1</sub>, to the level required to drive an audio power amplifier. The output of the preamplifier, coupled from the cathode of the 7199 triode section, may be applied directly to the power amplifier, or to an intermediate tone-control amplifier.



**25-20** **LOW-DISTORTION PREAMPLIFIER**  
For Low-Output, High-Impedance Microphones



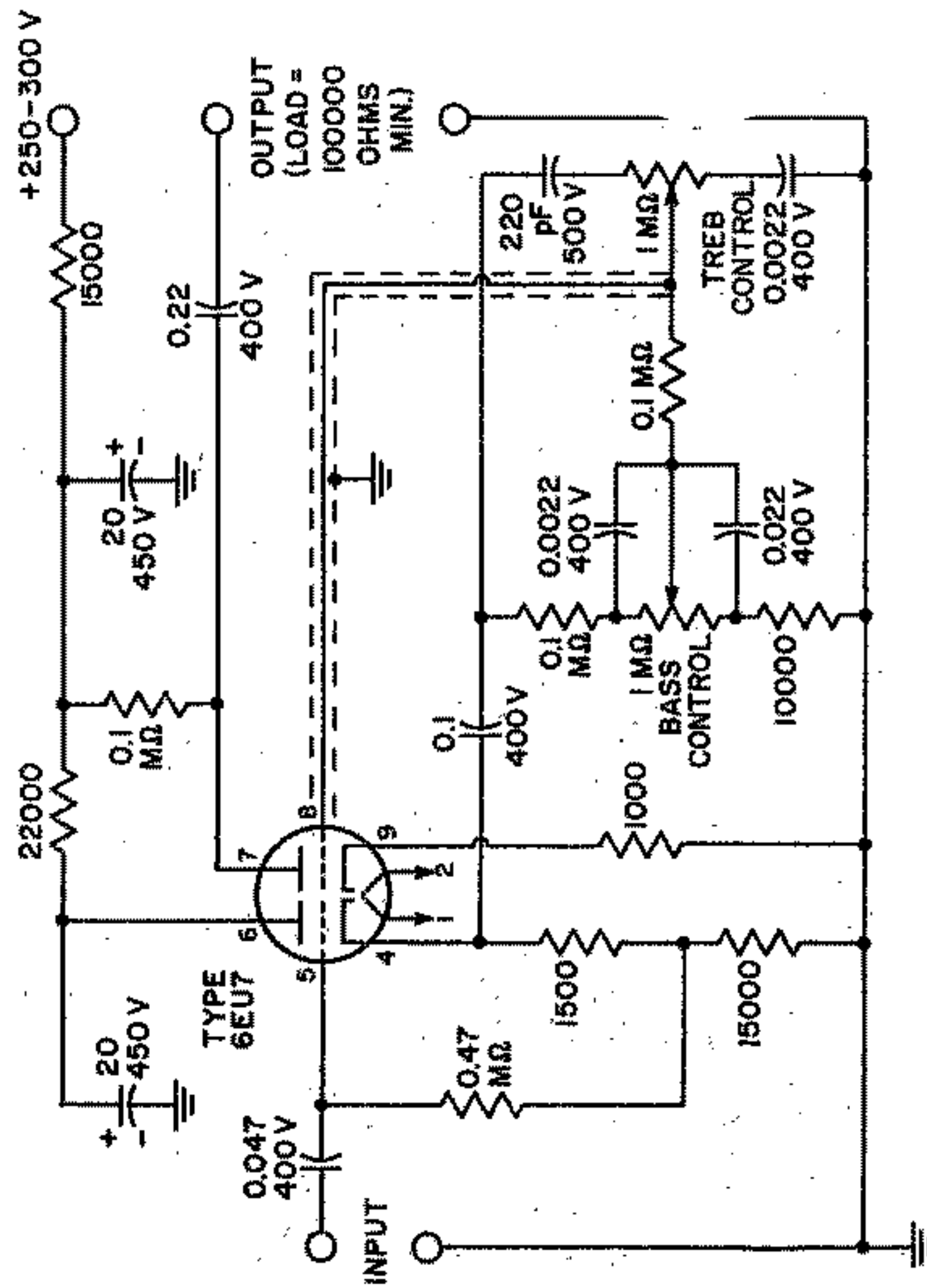
**Circuit Description**

This single-stage preamplifier is intended for use with a high-fidelity, high-impedance crystal or dynamic microphone. The circuit uses a 5879 low-noise sharp-cutoff pentode in a conventional amplifier circuit that has a high-impedance output, a voltage gain of approximately 70, and a flat frequency response over the audio range. Because of its high output impedance, the preamplifier should be mounted on the same chassis as the power amplifier and tone-control amplifier (if used). Heater and dc power for the circuit can be obtained from the power supply for the audio power amplifier.

Sensitivity = 3 millivolts rms input for output of 220 millivolts.

- Notes: 1. Resistance in ohms and capacitance in microfarads unless otherwise specified.  
2. All resistors 0.5 watt unless otherwise specified.

25-21 BASS AND TREBLE TONE-CONTROL AMPLIFIER



Sensitivity = 0.5 volt rms input for output of 1.25 volts with controls set for flat response.

- Notes: 1. Resistance in ohms and capacitance in microfarads unless otherwise specified.  
 2. All resistors 0.5 watt unless otherwise specified.  
 3. Potentiometers should have audio taper.

**Circuit Description**

This high-fidelity tone-control amplifier uses a 7025 low-noise twin triode in a two-stage amplifier cascade that consists of an input cathode follower connected to a triode voltage amplifier through a frequency-sensitive (tone-control) interstage coupling network. The bass and treble controls in the coupling network can be adjusted to provide up to 16 dB of boost or attenuation (cut) at 30 Hz and at 15 kHz. With the bass and treble controls set at the mid-range

positions, the amplifier provides an over-all voltage gain of approximately 2.5, and its frequency response is flat within  $\pm 1$ dB from 30 Hz to 15 kHz.

The tone-control amplifier is designed for use immediately ahead of an audio power amplifier, such as the 15-, 30-, or 50-watt unit (circuit 25-10, 25-11, or 25-12, respectively). Operating power for the tone-control circuit can usually be obtained from the power supply for the power am-

plifier. For operating convenience, the volume control on the power amplifier may be physically located on the tone-control chassis. In this case, it is advisable to insert a 1-megohm potentiometer in place of the volume control on the power amplifier. If partial compensation for the reduced high- and low-frequency sensitivity of the ear at low volume levels is desired, the volume-control potentiometer may be replaced by a loudness-control potentiometer.





**SINE- SQUARE-WAVE AUDIO-SIGNAL GENERATOR (Cont'd)**

**L<sub>1</sub>** = Lamp, 3 watts, 120 volts  
**L<sub>2</sub>** = Pilot lamp, No. 47  
**L<sub>3</sub>** = Filter choke (reactor), RCA stock No. 220215 or equiv.

**S<sub>1</sub>** = Rotary switch; sine-square attenuation selector; 8 positions, 3 wafers; RCA stock No. 220216 or equiv.  
**S<sub>2</sub>** = Rotary switch; frequency range selector; 4 positions, 2 wafers; RCA stock No. 220217 or equiv.

**S<sub>3</sub>** = On-Off switch.  
**T<sub>1</sub>** = Power transformer; 117 volts rms, 60 Hz; RCA stock No. 220214 or equiv.

\* On each range, the frequency of the generator is adjusted by means of a variable two-gang capacitor, RCA stock No. 220226 or equiv.

**SWITCH POSITIONS**

S <sub>2</sub> Frequency Range	S <sub>1</sub> Sine/Square
1-X1	1-Sine X10
2-X10	2-Sine X1
3-X100	3-Sine X0.1
4-X1000	4-Sine X0.01
	5-Square X0.01
	6-Square X0.1
	7-Square X1
	8-Square X10

**Sine-Wave Output:** 0 to 8 volts rms.  
**Square-Wave Output:** 0 to 10 volts, peak.  
**Frequency Ranges:** 20 to 200 Hz; 200 to 2000 Hz; 2000 to 20000 Hz; 20000 to 200000 Hz.

- Notes:**
1. "Sine-Square Attenuator" S<sub>1</sub>, shown in "X10" position.
  2. "Freq. Range" selector, S<sub>2</sub>, shown in "X1" position.
  3. Resistance in ohms and capacitance in microfarads unless otherwise specified.
  4. DC voltages shown are measured between points indicated and ground with a vacuum-tube voltmeter.

This audio generator is similar to the RCA type WA-44C.

### Circuit Description

This audio-signal generator provides sine-wave or square-wave outputs at frequencies from 20 Hz to 200 kHz. The sine-wave outputs are adjustable from 0 to 10 volts rms, and the square-wave outputs are adjustable from 0 to 10 volts peak. The generator also provides a fixed-frequency (60-Hz) sine-wave output that is variable in amplitude from 0 to 6 volts rms. The 117-volt, 60-Hz ac input power to the generator is converted to dc operating power for the various circuit stages by a 6X4 full-wave rectifier circuit. Power for the tube heaters is supplied by a 6.3-volt winding of power transformer T<sub>1</sub>. A panel lamp connected across this secondary winding lights

when ON-OFF switch S<sub>3</sub> is closed to indicate the application of ac input power to the generator. A second 6.3-volt secondary winding of transformer T<sub>1</sub> provides the fixed-frequency sine-wave output. This 60-Hz signal is coupled from the wiper arm of the output voltage control connected across the 6.3-volt winding.

The basic excitation in the main signal channel of the generator is provided by a variable-frequency bridged-T type of sine-wave oscillator in which the required amplification and switching are provided by the pentode section of a 6U8A triode-pentode. The Frequency-Range selector S<sub>2</sub>, a four-position, two-section rotary switch, connects the proper

combination of resistors into the bridged-T network to establish the desired frequency range for the oscillator—20 to 200 Hz (X1 position), 200 to 2000 Hz (X10 position), 2 to 20 kHz (X100 position), or 20 to 200 kHz (X1000 position). A two-gang variable (split-stator) capacitor C<sub>2</sub> provides a vernier control of the oscillator frequency on each range. Capacitors C<sub>1</sub> and C<sub>3</sub> are trimmer adjustments for the oscillator.

The sine-wave signal developed in the plate circuit of the oscillator stage is coupled to the control grid of a 6AQ5 pentode amplifier stage that provides both plate and cathode signals. The cathode signal is the sine-wave output of the generator.

**Circuit Description (Cont'd)**

The plate signal is used to derive the square-wave output of the generator. The setting of the SINE-SQUARE attenuation selector  $S_1$ , an eight-position three-section rotary switch, determines whether the generator provides sine-wave or square-wave outputs. In addition, the selector provides four levels of attenuation for each type of output, as shown in the switch-position chart.

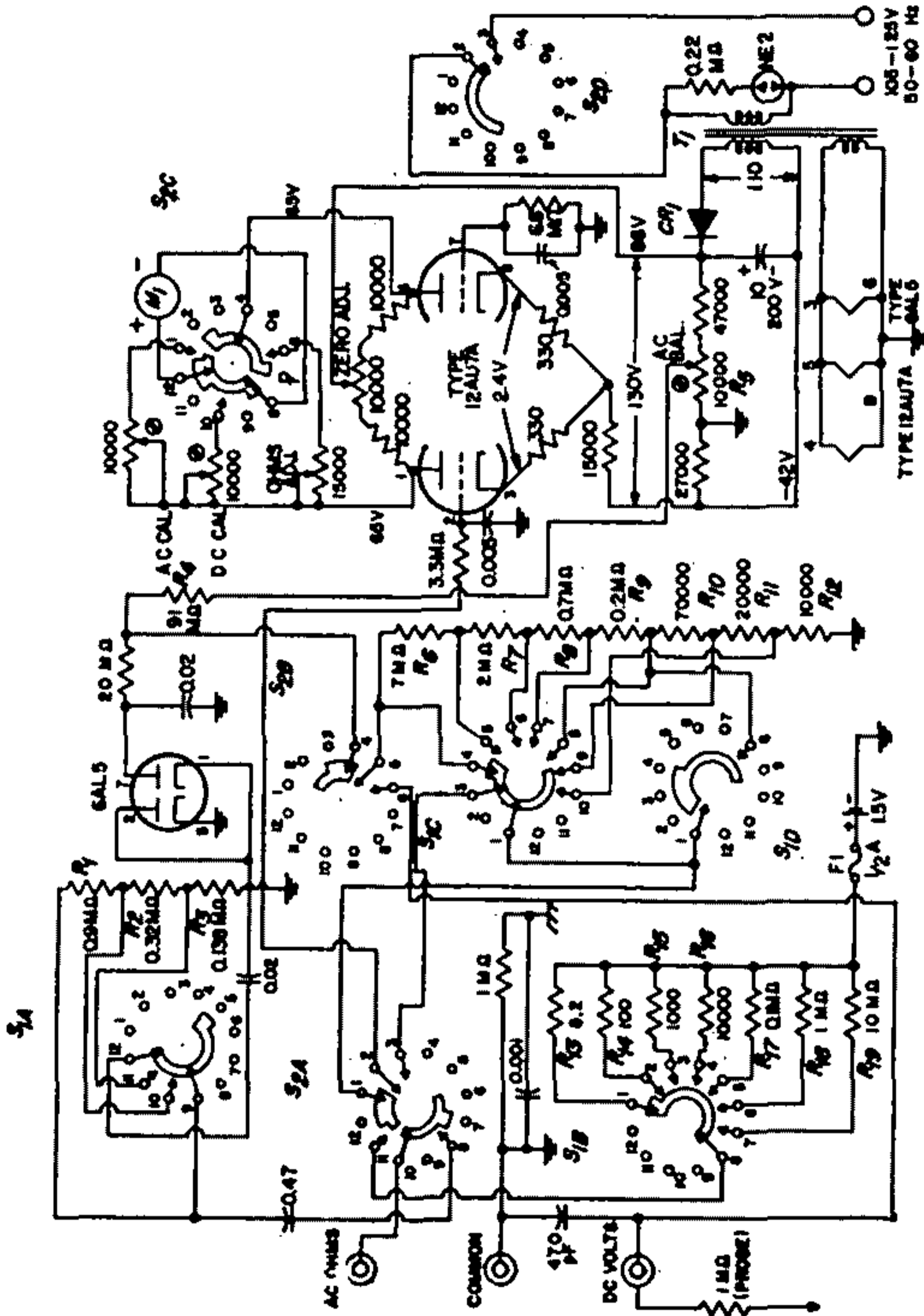
With the attenuation selector set to any one of the four square-wave positions, the sine-wave signal from the plate of the 6AQ5 stage is coupled through the  $S_{1A}$  section of the selector to the shaping amplifiers. The shaping amplifiers consist of two triode limiters and a pentode cath-

ode-follower output stage in cascade. The triode limiters, each of which uses the triode section of a 6U8A triode-pentode, clip the positive and negative peaks of the sine-wave input to produce a square-wave signal. This signal is applied to the control grid of the pentode section of the 6U8A triode-pentode used in the cathode-follower output stage. The resulting square-wave signal developed across the square-wave output control is coupled from the wiper arm of the control through the  $S_{1B}$  section of the SINE-SQUARE attenuation selector to the output attenuation network. If the attenuation selector is set to one of the four sine-wave positions, no square wave

is developed, and the sine-wave signal from the wiper arm of the sine-wave output control is coupled through the  $S_{1B}$  section of the attenuation selector to the output network.

The output attenuation network is a tapped resistive voltage divider that provides four output levels with the three lower levels successively decreased to one-tenth of the next higher one. The  $S_{1C}$  section of the attenuation selector determines the tap on the voltage divider from which the sine-wave or square-wave output is obtained. The sine-wave or square-wave OUTPUT control provides continuous adjustment of the output level for any attenuation setting.

25-23 ELECTRONIC VOLT-OHM METER





CR<sub>3</sub> = Selenium rectifier, Radio Receptor Co. No. 8Y1B or equiv.  
 M<sub>1</sub> = Meter, dc, 0-200 microamperes  
 S<sub>1</sub> = Range selector, 7-position rotary switch, RCA stock No. 217924 or equiv.  
 S<sub>2</sub> = Function selector, 5-position rotary switch, RCA stock No. 217923 or equiv.  
 T<sub>1</sub> = Power transformer, 105 to 125 volts rms, 50 to 60 Hz, RCA stock No. 217921 or equiv.

- Notes: 1. Switches are shown in their maximum counterclock-wise positions (S<sub>1</sub> = 1.5 V, R X 1; S<sub>2</sub> = "OFF").  
 2. Resistance in ohms and capacitance in microfarad unless otherwise specified.  
 3. All resistors 0.5-watt and all capacitor 400-volt unless otherwise specified.  
 For home construction of this or a similar circuit, the complete Kit-WV-77E(K) or RCA-WV-98C(K) is recommended because of the large number of special components used.  
 4. DC voltages shown are measured with respect to circuit ground unless otherwise indicated, under following conditions; ac line voltage, 117 volts; Function selector S<sub>2</sub> at "+ DC"; Range Switch S<sub>1</sub> at "1500 V."

SWITCH POSITIONS

Position	Range Selector, S <sub>1</sub>	Function Selector, S <sub>2</sub>
1	1.5V	OFF
2	5V	AC VOLTS
3	15V	-DC VOLTS
4	50V	+DC VOLTS
5	150V	OHMS
6	500V	
7	1500V	

### Circuit Description

This electronic volt-ohm meter can be used to measure rms values of ac sine-wave voltages from 0.1 to 1500 volts, dc voltages from 0.2 to 1500 volts, peak-to-peak voltages from 0.2 to 4000 volts, and resistances from 0.2 ohms to 1000 megohms. Within these over-all limits, a Range Selector ( $S_1$ ) can be used to select seven different measurement ranges for each measurement function, as shown in the switch-position chart. The mode of operation of the volt-ohm meter is determined by the setting of the five-position (OFF, AC, -DC, +DC, and OHMS) Function Selector ( $S_2$ ). A section ( $S_{2D}$ ) of the Function Selector is also used to control the application of the 117-volt, 60-Hz, input ac power. The ac input power is converted to dc power by the selenium rectifier CR<sub>1</sub> and

associated components. A 6.3-volt secondary winding of power transformer T<sub>1</sub> supplies power to the tube heaters. A neon lamp connected across the primary of power transformer T<sub>1</sub> lights when ac power is applied to the circuit.

A balanced push-pull dc amplifier, which includes a dc microammeter connected as part of a dc bridge network between the two plate sections of the stage, is used as the basic measuring circuit for each measurement function of the volt-ohm meter. This circuit has a linear response, excellent stability, and a very high input impedance. Calibration adjustments are provided for each mode of operation to assure that accurate measurements are obtained. If desired, the ZERO ADJ potentiometer may be adjusted to provide a center-

scale zero reading on the meter, which is useful in discriminator and bias voltage measurements.

For ac voltage measurements, Function Selector  $S_2$  must be rotated to the AC position. The ac voltage to be measured, applied between the AC-OHMS and COMMON terminals, is coupled through contacts 10 and 9 of  $S_{1A}$  to the ac-voltmeter multipliers ( $R_1$  through  $R_8$ ). The ac voltage from one of the taps on the multiplier, as determined by the setting of the Range Selector ( $S_{1A}$  section), is rectified by the 6AL6 twin diode. The resultant dc voltage across the rectifier bleeder resistors  $R_4$  and  $R_5$  is proportional to the ac voltage from the multiplier network. This voltage is then coupled through contacts 4 and 5 of  $S_{2A}$ , through one of the contacts 4 through 10 (as determined

**Circuit Description (Cont'd)**

by setting of Range Selector) and contact 1 of  $S_{10}$ , and through contacts 1 and 2 of  $S_{2A}$  to the pin 2 control grid of the 12AU7A twin triode in the balanced dc amplifier. This input disturbs the balance of the amplifier and a current proportional to the ac input flows through the dc microammeter connected between the plates of the 12AU7. The pointer on the microammeter is then deflected to indicate the value of the voltage being measured.

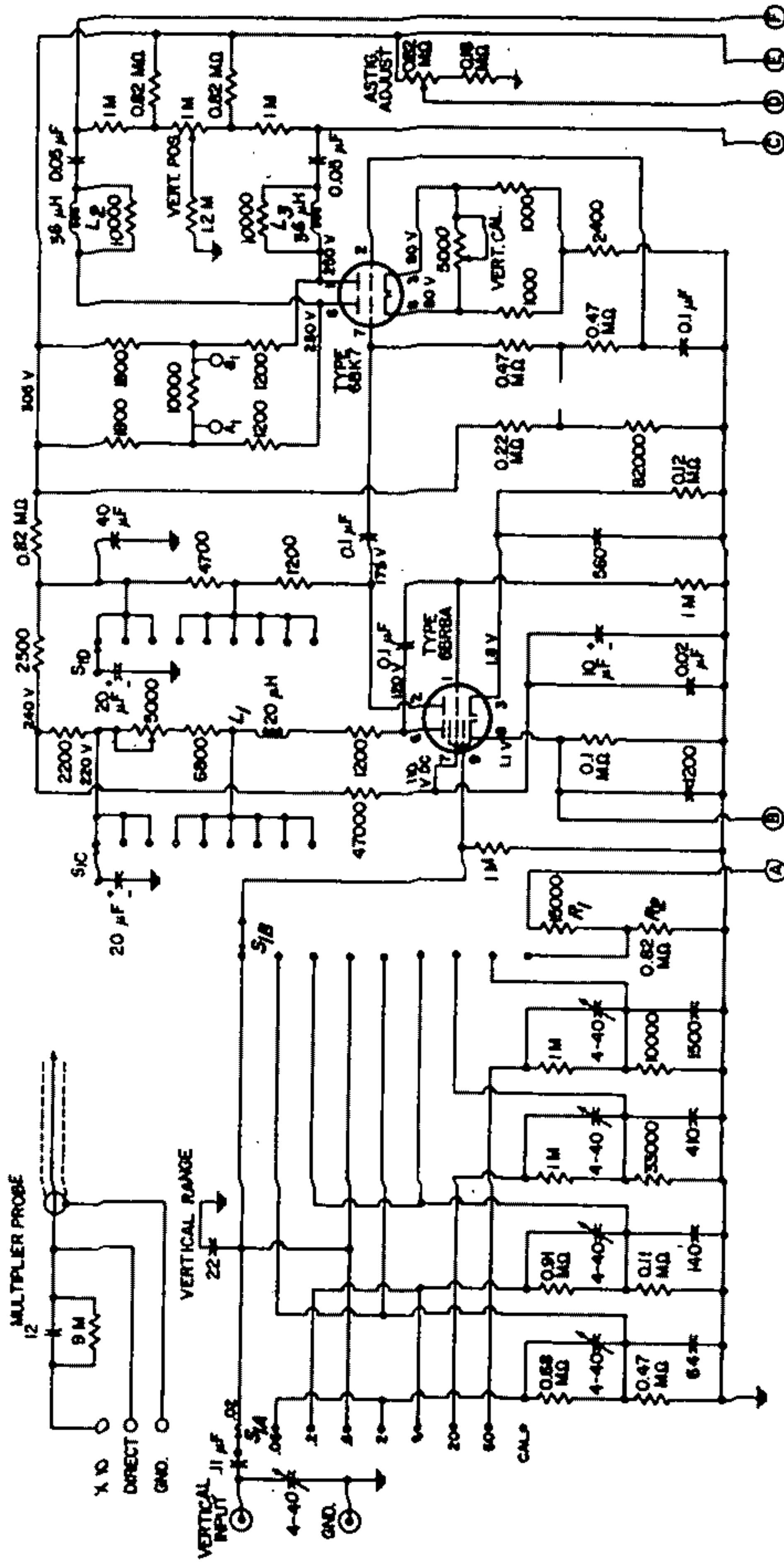
With the Function Selector rotated to either -DC or +DC, a dc voltage being measured is coupled through the 1-megohm probe, the DC VOLTS terminal, and contacts 6 and 5 of  $S_{2B}$  to the dc-voltmeter multipliers ( $R_6$  through  $R_{15}$ ). The 1-megohm resistance of the dc probe together with the resistance of the multipliers results in an input re-

sistance of 11 megohms for dc voltage measurements. The dc voltage from the appropriate tap on the multiplier network selected by the  $S_{10}$  and  $S_{11}$  sections of the Range Selector is coupled through contact 1 of these switch sections (or contact 3 of  $S_{10}$ ) and contacts 1 (or 3) and 2 of  $S_{2A}$  to the input of the balanced dc amplifier. The pointer of the microammeter in the balanced amplifier is then deflected to provide an indication of the value of the dc voltage being measured. The  $S_{20}$  section of the Function Selector reverses the connections of the microammeter when the Function Selector is rotated from -DC to +DC so that current will flow through the microammeter in the same direction regardless of whether a negative or positive dc voltage is being measured.

For resistance measurements,

the Function Selector is rotated to the OHMS position, and the external resistance to be measured is connected between the AC-OHMS and COMMON terminals of the volt-ohm meter. A 1.5-volt dry cell then causes current to flow through the external resistance, through contacts 10 and 11 of  $S_{2A}$ , and through one of the ohmmeter-section multiplier resistors ( $R_{16}$  through  $R_{19}$ ), as determined by the setting of the Range Selector ( $S_{10}$  section). Because the multiplier resistance is fixed for each range, the voltage developed across the external resistance provides an accurate indication of the value of this resistance. This voltage is coupled through contacts 10 and 2 of  $S_{2A}$  to the input of the balanced dc amplifier. The pointer of the microammeter is then deflected to indicate the value of the resistance being measured.

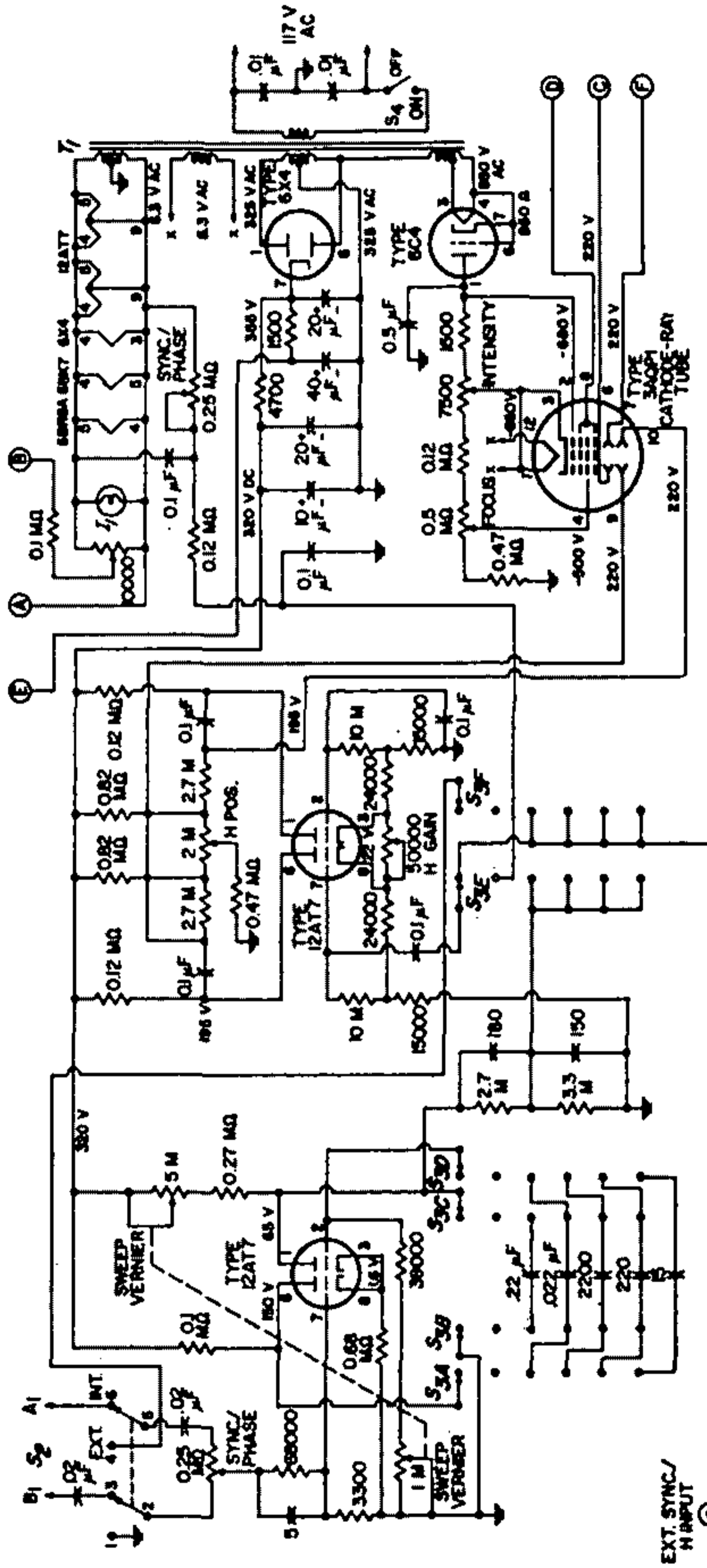
25-24 CATHODE-RAY OSCILLOSCOPE



**L<sub>1</sub>** = Pilot lamp, No. 47  
**L<sub>2</sub>** = Peaking coil, 20 μH  
**L<sub>3</sub>** = Peaking coil, 36 μH (wound on 10,000-ohm, 0.5-watt resistor)  
**S<sub>1</sub>** = Vertical range selector; rotary switch; 9 positions, 4 sections; RCA stock No. 219199 or equiv.  
**S<sub>2</sub>** = Horizontal sweep selector; rotary switch; 6 positions, 5 sections; RCA stock No. 219200 or equiv.  
**S<sub>3</sub>** = Sync selector; double-pole, double-throw switch; Stackpole Type SS-33 or equiv.  
**S<sub>4</sub>** = On-off switch  
**T<sub>1</sub>** = Power transformer 117 volts, 60 Hz; RCA stock No. 218122 or equiv.



25-24 CATHODE-RAY OSCILLOSCOPE (Cont'd)



- Notes: 1. Resistance in ohms and capacitance in picofarads unless otherwise specified.  
 2. For trimmer capacitors, use Arco No. 422 or equiv.  
 3. DC voltages shown are measured from points indicated to chassis ground with a vacuum-tube voltmeter.

Circuit Description

This oscilloscope provides a 3-inch cathode-ray-tube display of voltage waveforms at frequencies from 5.5 Hz to 5.5 MHz. It is very

useful, therefore, for signal tracing and monitoring in the servicing of black-and-white and color television receivers, AM and FM radio receivers, hi-fidelity audio systems, and other types of electronic equipment. The sensitivity of the oscilloscope is such that each 0.1 volt rms applied to

For home construction of this circuit, the complete kit RCA-WO-33A (K) is recommended because of the large number of special components used. The circuit is also available in wired form as the RCA-WO-33A.

## 25-24 CATHODE-RAY OSCILLOSCOPE (Cont'd)

### Circuit Description (Cont'd)

the vertical-input terminal results in a 1-inch vertical deflection of the electron beam on the 3-inch cathode-ray-tube screen. The unit operates from a 117-volt, 60-Hz ac power line. A 6X4 transformer-coupled full-wave rectifier circuit converts the ac input power to the +320 volts used as the main dc supply voltage for the oscilloscope. A half-wave rectifier circuit that uses a 6C4 triode connected to operate as a diode converts the ac power developed across a high-voltage winding of power transformer  $T_1$  to the -680 volts required for operation of the 3AQP1 cathode-ray tube. A 6.3-volt tap on the high-voltage winding of  $T_1$  provides the heater power for the 6C4. A 6.3-volt secondary winding of  $T_1$  provides the heater power for the 3AQP1 cathode-ray tube, and a center-tapped 12.6-volt winding supplies heater power for the remainder of the tubes in the oscilloscope.

A signal waveform applied to the vertical-input terminal is routed through contacts of the  $S_{1A}$  section of the Vertical Range selector to one of the input attenuation networks. The  $S_{1B}$  section of the Vertical Range selector couples the attenuated signal waveform from the appropriate

input network to the input of the vertical amplifiers. The  $S_{1C}$  and  $S_{1D}$  sections of the Vertical Range selector automatically switch the vertical amplifiers from wide-band to narrow-band operation in the three highest-gain (lowest-attenuation) positions, as indicated in the switch-position chart. With the Vertical Range selector in the CAL position, the vertical-input terminal and input attenuation networks are disconnected from the vertical amplifiers, and an internal calibrating (reference) voltage, obtained from the junction of voltage-divider resistors  $R_1$  and  $R_2$ , is applied to the input of the vertical amplifiers. This calibrating voltage, the fact that the input attenuation networks are voltage calibrated, and the use of a graph screen scaled directly in volts make possible the use of the oscilloscope as a visual peak-to-peak voltmeter.

The signal waveform from the input attenuation network is amplified by a two-stage vertical-amplifier cascade that uses a 6BR8 in a high-gain pentode input stage and a triode voltage amplifier. The output of the triode amplifier drives a 6BK7 twin triode used in the vertical paraphase amplifier. The 6BK7

is operated in a push-pull differential-amplifier configuration to provide two equal-amplitude outputs (one from each plate section) that are 180 degrees out of phase. These signals are applied to opposite vertical deflection plates of the 3AQP1 cathode-ray tube to provide the push-pull vertical deflection of the electron beam that causes the horizontal sweep to track the signal waveform applied to the vertical-input terminal. The exceptionally high gain of the vertical-amplifier stages make the oscilloscope sensitive enough to provide useful displays of signals from low-level microphones, phonograph pickups, and other low-output sources. The VERT. CAL. control in the cathode circuit of the vertical paraphase amplifier adjusts the sensitivity or calibrates the vertical amplifier to correspond with the position of the Vertical Range selector.

The circuits used to produce the horizontal sweep on the oscilloscope screen include a horizontal oscillator (sawtooth generator) and a horizontal paraphase amplifier, each of which uses a 12AT7 twin triode. The oscillator generates sawtooth waveforms, at frequencies from 15 Hz to 75 kHz, in four basic ranges. The

## 25-24 CATHODE-RAY OSCILLOSCOPE (Cont'd)

### Circuit Description (Cont'd)

Sweep Selector  $S_3$  connects the proper combination of capacitors into the stage for each range. The Sweep Vernier control, which overlaps the basic frequency ranges, provides exact adjustment of the sweep frequency. The oscillator exhibits excellent stability at high sweep rates, has a fast retrace, and provides adequate linearity throughout its over-all frequency range. With the Sweep Selector set to any of the positions 3 through 6, the sawtooth waveform from the oscillator is applied to the pin 7 control grid of the 12AT7 twin triode used in the horizontal paraphase amplifier. The horizontal paraphase amplifier, which is essentially identical to the vertical paraphase-amplifier except for significant differences in frequency-response characteristics, develops two equal-amplitude sawtooth waveforms that are 180 degrees out of phase. These waveforms are applied to opposite horizontal-deflection plates of the 3AQ1 cathode-ray tube to provide the push-pull deflection of the electron beam that results in a linear horizontal sweep on the oscilloscope screen.

The horizontal oscillator may be synchronized by either internal or

external signals. With the Sync Selector  $S_2$  set to INT, a signal from the vertical paraphase amplifier (points  $A_1$  and  $B_1$ ) synchronizes the oscillator to assure that the start of the horizontal sweep is coincident with the start of the signal applied at the vertical-input terminal. For internal-sync operation, the Sync/Phase control at the input of the oscillator has its zero setting at the mid-range position and may be used to adjust both the amplitude and phase of the synchronizing voltage to lock the oscilloscope pattern to a stationary position. With the Sync Selector set to EXT, a signal from an external source, coupled through the EXT. SYNC/H INPUT terminal and contacts of  $S_{5F}$  (in positions 3 through 6) is used to synchronize the oscillator. For external-sync operation, the Sync/Phase control adjusts the amplitude of the external synchronizing voltage by normal clockwise rotation and the phase control feature is not provided (center position of control is not zero).

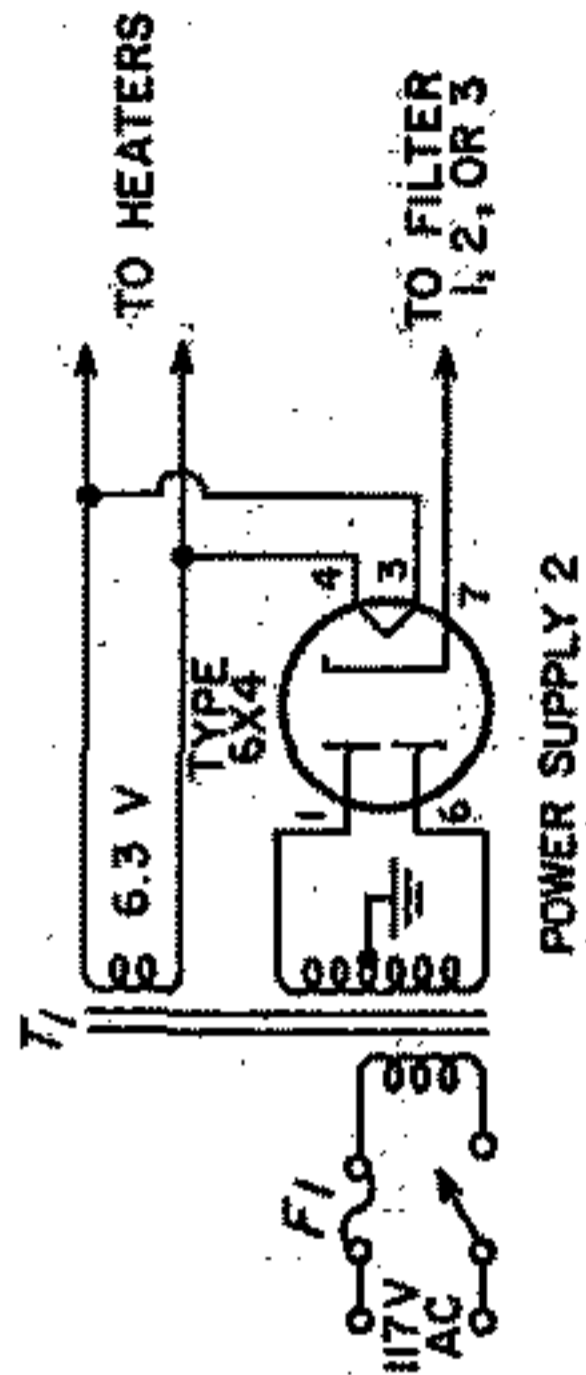
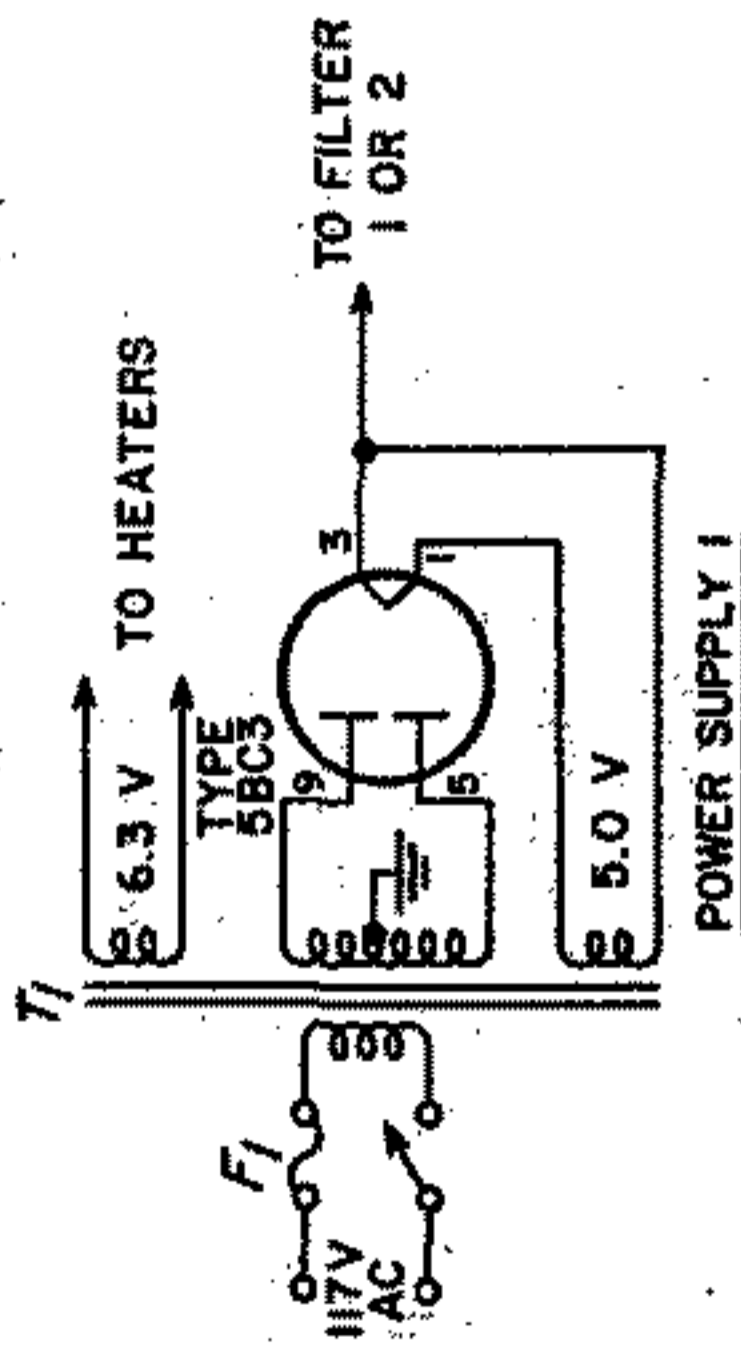
If desired, a signal from an external horizontal oscillator or the 60-Hz line voltage may be used to produce the sweep on the oscilloscope screen. With the Sweep Selec-

tor set to either HOR IN or to LINE, the horizontal oscillator is disconnected from the circuit, and the input to the horizontal amplifier is then obtained from either the EXT SYNC/H INPUT terminal or the center-tapped 12.6-volt heater winding of power transformer  $T_1$ .

The three-lead accessory probe shown with the circuit schematic facilitates the use of the oscilloscope. The ground lead of the probe is connected to the ground terminal of the oscilloscope, and the vertical input is then applied through the direct or the X10 attenuation lead. When the direct lead is used, the signal is applied directly to the vertical-input terminal. When the attenuation lead is used, a high-impedance network in the probe is connected in series with the test point and the vertical-input terminal of the oscilloscope. This high-impedance network presents an over-all input resistance of 10 megohms and an input capacitance of approximately 10 picofarads to the test circuit. This high impedance reduces circuit-loading effects and permits use of the oscilloscope in circuits which do not function properly if loaded by a conventional oscilloscope.



ALL-PURPOSE POWER SUPPLY



Circuit Description

In these power-supply circuits, 5BC3 and 6X4 full-wave rectifier tubes are used to convert ac input power to dc output power in various combinations of output voltage and load current. The 5BC3 tube is a directly heated novar type intended for use in power supplies for radio equipment, television receivers, and other applications that have relatively high dc requirements. The 6X4 tube is an indirectly heated miniature type used primarily in power supplies for automobile and ac-operated radio receivers and other equipment that have moderate dc requirements.

In each rectifier circuit, the 117-volt ac input power is applied to the primary of a step-up power transformer T<sub>1</sub>. The two plate sections of

the rectifier tube are connected to opposite ends of the center-tapped secondary winding of transformer T<sub>1</sub>. With respect to the grounded center tap, the voltage applied to each plate of the rectifier tube, therefore, is 180 degrees out of phase with that applied to the other plate. With an external load connected to the rectifier cathode, pulses of current flow alternately to one plate and then to the other plate for each half cycle of the ac input power. This 120-Hz pulsating current develops a positive dc voltage across the load circuit.

Removal of virtually all the 120-Hz ripple component from the dc output can be accomplished by connection of a suitable filter network between the rectifier output

(cathode) and the load circuit. Either Filter 1 or Filter 2 provides adequate filtering for the 5BC3 circuit. Any one of the three filter networks is satisfactory for use with the 6X4 circuit. Filter 3 is not recommended for use with the 5BC3 circuit because the use of the two resistors R<sub>1</sub> and R<sub>2</sub> in series with the relatively high output results in excessive power loss.

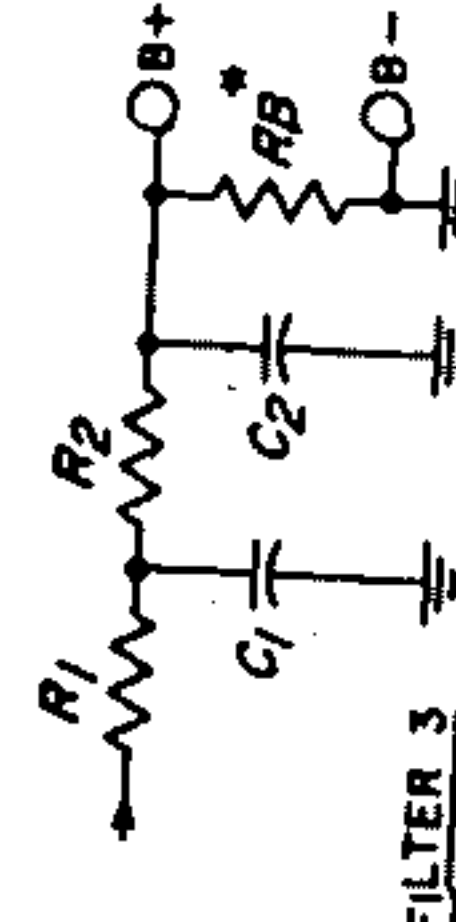
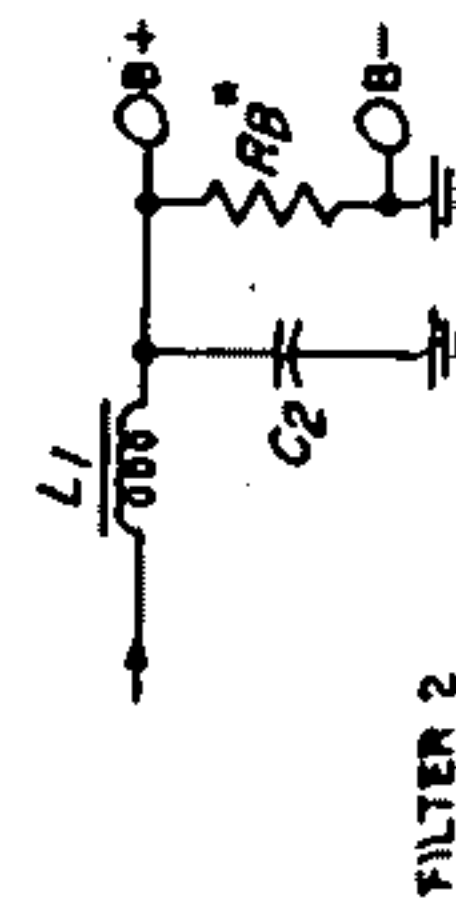
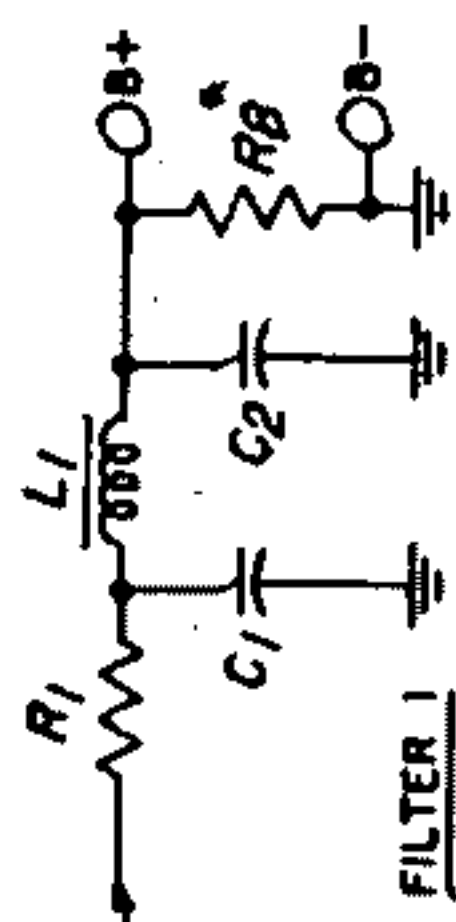
The chart shown with the rectifier circuits lists a wide range of dc output voltage obtainable for various values of load current. Proper selection of power transformer T<sub>1</sub>, of the type of filter network, and of the values of filter choke L<sub>1</sub> and resistors R<sub>1</sub> and R<sub>2</sub> results in the desired combination of output voltage and current.



25-25 ALL-PURPOSE POWER SUPPLIES (Cont'd)

POWER SUPPLY	TRANS-FORMER	CHOKE (L <sub>1</sub> )	R <sub>1</sub>	R <sub>2</sub>	C <sub>1</sub> , C <sub>2</sub>	FIL-TER	OUTPUT VOLTS	mA
1 (SBC3)	Stancor PC or PM 8177 (300-0-300) or equiv.	140 mA, 7H, 165 ohms Stancor C1421 or equiv.	33 ohms 5W	—	40 μF 450 Vdc	1	360	60
							340	80
							320	120
1 (SBC3)	Stancor PC or PM 8412 (400-0-400) or equiv.	200 mA, 4H, 145 ohms Thoradaron 20C54 or equiv.	56 ohms 10W	—	40 μF 600 Vdc	1	450	120
							425	160
							410	200
2 (6X4)	Stancor P-6358 (300-0-300) or equiv.	80 mA, 12H, 375 ohms Thoradaron 20C53 or equiv.	500 ohms 5W	500 ohms 3W	40 μF 450 Vdc	1	350	20
							300	40
							260	60
2 (6X4)	Stancor PM or PC 8419 (240-0-240) or equiv.	80 mA, 12H, 375 ohms Thoradaron 20C53 or equiv.	500 ohms 5W	500 ohms 3W	40 μF 450 Vdc	1	265	20
							225	40
							190	60
2 (6X4)	Stancor PM or PC 8419 (240-0-240) or equiv.	80 mA, 12H, 375 ohms Thoradaron 20C53 or equiv.	500 ohms 5W	500 ohms 3W	40 μF 450 Vdc	2	200	20
							180	40
							170	60
3 (6X4)	Stancor PM or PC 8419 (240-0-240) or equiv.	80 mA, 12H, 375 ohms Thoradaron 20C53 or equiv.	500 ohms 5W	500 ohms 3W	40 μF 450 Vdc	3	260	20
							220	40
							180	60

\* Bleeder R<sub>2</sub> can be omitted if an external load is permanently connected across the output terminals. Bleeder current should be approximately 10 per cent of the load current.



## TELEVISION CIRCUITS

Circuits 25-26 through 25-30 are essentially identical to the corresponding circuits in the RCA-KCS-152 Television Receiver. These circuits comprise a complete intercarrier television receiver with the exception of the deflection coils and the picture tube. Portions of any television receiver, however, are required to operate over an extremely wide range of very high frequencies. The construction of such circuits requires more than ordinary skill and experience and the use of sophisticated test equipment (see general consideration for the construction of high-frequency and broad-band circuits at the beginning of this section). Home construction of such circuits is not recommended unless the builder has had considerable experience in this type of work.

The chassis of circuits 25-26 through 25-30 are connected to one side of the ac line during operation. Servicing of these circuits should

not be attempted by persons not familiar with the following precautions necessary when working on this type of equipment:

1. An isolation transformer should be inserted between the receiver and the ac line before any servicing is attempted.
2. If the receiver must be operated directly from the ac supply, the power plug should be inserted in the proper direction to connect the chassis to the ground side of the ac line. An ac voltmeter should be used to measure the voltage between the chassis and the power-source ground; no voltage reading should be obtained. If a reading is obtained, the power plug should be reversed and another check made for a zero reading.

## 25-26 VHF TUNER

For Black-and-White Television Receiver

### Circuit Description

This vhf tuner selects the desired vhf frequency channel, amplifies composite video signals in the frequency channel selected, and converts the signal frequencies to the 45.75-MHz picture intermediate frequency and the 41.25-MHz sound intermediate frequency used in television receivers. When used with a uhf tuner, the vhf tuner is operated as a two-stage broadband rf amplifier tuned to 44 MHz (center frequency of the if band) and is essentially a pre-if amplifier for the television receiver. In each mode of operation, the tuner has a band pass that is broad enough to pass all the video information (including synchronizing and equalizing pulses) and the sound information superimposed on the video and sound carrier frequencies and has sufficient selectivity to assure adequate adjacent-channel and image-frequency rejection. The +140 volts used as

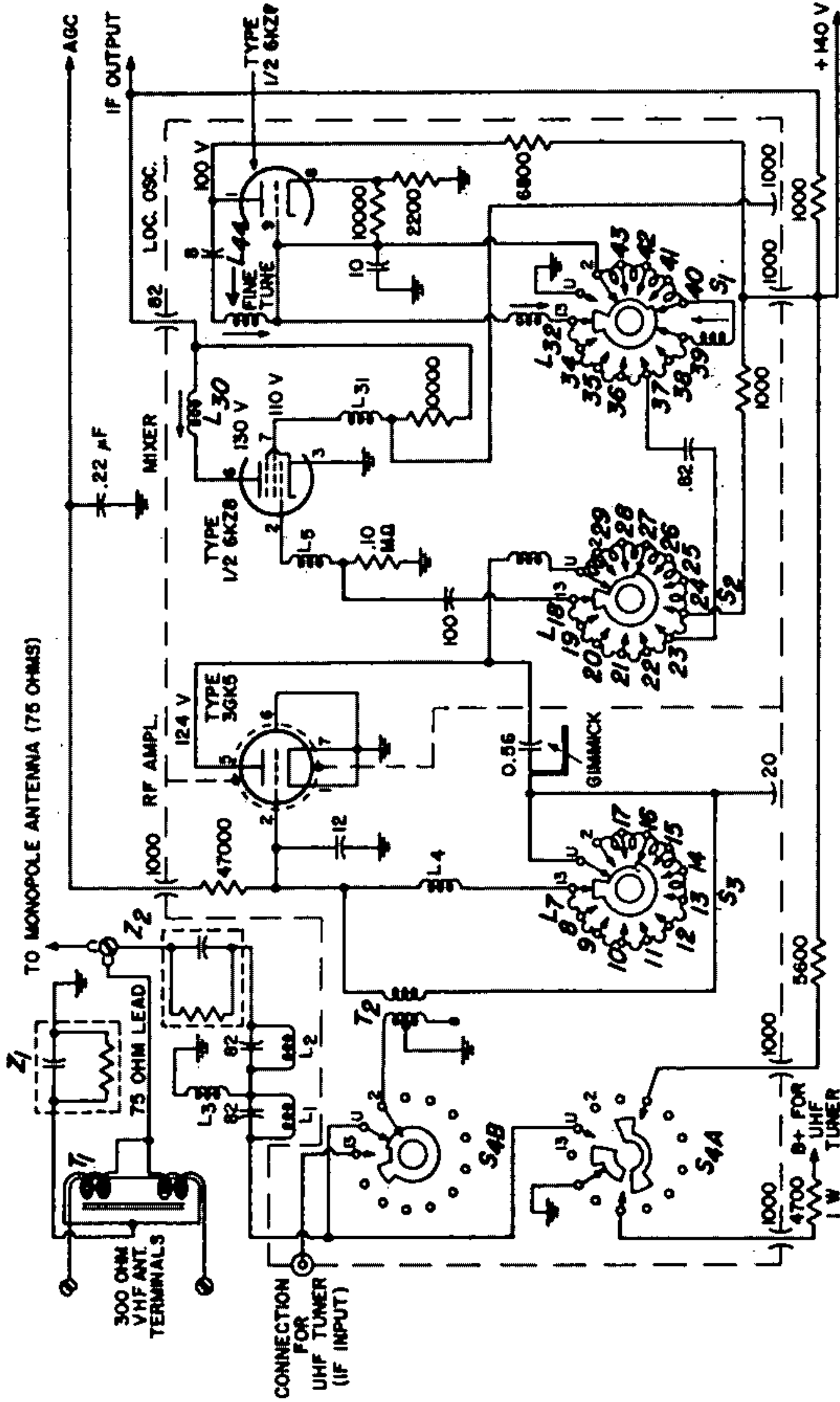
the B+ supply for the vhf tuner is obtained from the low-voltage power supply of the receiver. The heaters of the tubes in the circuit are connected in series with those of other tubes in the receiver, and power for the series heater string is obtained directly from the input ac power line.

The antenna used with the vhf tuner may be either a 75-ohm monopole, as used with portable receivers, or a balanced 300-ohm antenna. A balanced 300-ohm antenna system can be matched to the unbalanced 75-ohm tuner input by means of the antenna-matching balun T<sub>1</sub>. A 13-position channel selector, which consists of several wafer-switch sections (S<sub>1</sub> through S<sub>4</sub>) mounted on a common shaft, establishes the operating frequency of the tuner for each of the vhf channels 2 through 13 or adapts the vhf tuner for operation with a uhf tuner. With S<sub>1</sub> set

to any of the channel positions 2 through 13, the selected-channel signal from the vhf tuner is coupled through contacts U and 2 of S<sub>5B</sub> and input transformer T<sub>2</sub> to the rf amplifier, and the input lead from the uhf tuner is not connected to the vhf circuit.

The vhf input signals are amplified by the 3GK5 high-imp frame-grid triode used in the rf amplifier stage. The S<sub>2</sub> section of the channel selector connects the appropriate combination of the inductors L<sub>1</sub> through L<sub>7</sub> into the grid circuit of the rf amplifier to tune this stage to the desired frequency channel. The agc bias voltage applied to the control grid of the 3GK5 triode automatically controls the gain of the rf stage. The bias voltage, which varies directly with the amplitude of the received signal, is derived by a keyed agc amplifier in the television receiver.

25-26 VHF TUNER (Cont'd)





**GIMMICK** = Trimmer-capacitor plate  
 $L_1$   $L_2$   $L_3$  = RF coils; with two 82-pico-farad capacitors, forms high-pass filter (antenna input network), RCA Stock No. 114458 or equiv.  
 $L_4$  = RF amplifier grid coil, part of  $S_3$  assembly  
 $L_5$  = Mixer grid coil, part of  $S_2$  assembly  
 $L_6$  = Interstage coupling coil for rf amplifier and mixer, part of  $S_2$  assembly  
 $L_7$  through  $L_{17}$  = RF-amplifier tuning coils, part of  $S_2$  assembly  
 $L_{18}$  through  $L_{20}$  = Mixer tuning coils, part of  $S_2$  assembly  
 $L_{21}$  = Variable rf coil; mixer plate tuning adjustment; RCA stock No. 112909 or equiv.  
 $L_{22}$  = RF choke

$L_{23}$  = Variable rf coil; local-oscillator tuning adjustment for channel 13  
 $L_{24}$  through  $L_{28}$  = Local-oscillator tuning coils (variable coil  $L_{25}$  is tuning adjustment for channel 6), part of  $S_1$  assembly  
 $L_{29}$  = Variable rf coil; fine-tuning control; RCA Stock No. 113323, or equiv.  
 $S_1$  = Local-oscillator section of channel selector switch; stator assembly, RCA Stock No. 114462 or equiv., includes local-oscillator tuning coils  $L_{23}$  through  $L_{28}$   
 $S_2$  = Mixer section of channel-selector switch; stator assembly, RCA Stock No. 114461 or equiv., includes mixer tuning coils  $L_7$ ,  $L_8$ , and  $L_{18}$  through  $L_{20}$

$S_3$  = RF amplifier section of channel-selector switch; stator assembly, RCA Stock No. 114460 or equiv., includes rf-amplifier tuning coils  $L_4$  and  $L_7$  through  $L_{17}$   
 $S_4$  = VHF-UHF function selector; two-section switch ganged with channel selectors  $S_1$ ,  $S_2$ , and  $S_3$ ; RCA Stock No. 114185 or equiv.  
 $T_1$  = Antenna-matching balun; matches 300-ohm balanced antenna-lead line to 75-ohm unbalanced receiver-input line; RCA Stock No. 111973 or equiv.  
 $T_2$  = Antenna transformer; RCA Stock No. 113195 or equiv.  
 $Z_1$   $Z_2$  = Resistance-capacitance network (capacitor), RCA stock No. 109956 or equiv.

- Notes:**
1. All switches are ganged together on same shaft and are shown with shaft in channel 13 position.
  2. Resistance values in ohms and capacitance values in picofarads, unless otherwise specified.
  3. All resistors 0.5 watt  $\pm 10\%$  and all capacitors 500 volt unless otherwise specified.
  4. Voltages shown are obtained with no signal input.
  5. For dc voltage and heater supply, see circuit 25-30, page 596.
  6. See additional notes on page 580.

### Circuit Description (Cont'd)

The output of the rf amplifier is coupled through a resonant impedance network to the control grid of the 6KZ8 pentode section used in the

mixer stage. Section  $S_2$  of the ganged channel selector selects the proper combination of the inductor  $L_{23}$  through  $L_{28}$  to tune the mixer input

circuit to the same operating frequency as that of the rf amplifier. A signal from the plate of the 6KZ8 triode section used in the local-oscil-

## Circuit Description (Cont'd)

lator stage is also applied to the input circuit of the mixer. Section  $S_1$  of the channel selector connects the right combination of the inductors  $L_{23}$  through  $L_{25}$  into the oscillator resonant circuit to maintain the operating frequency of the oscillator at 42.25 MHz above the video carrier frequency of the vhf channel selected by the tuner. Inductor  $L_{22}$  in the series-resonant feedback circuit of the oscillator is the fine-tuning adjustment for the vhf tuner. This adjustment assures that the oscillator frequency accurately tracks the input tuning in each channel.

The signals from the rf amplifier and the local oscillator are heterodyned in the mixer stage to produce the 45.75-MHz amplitude-modulated and 41.25-MHz frequen-

cy-modulated difference frequencies used as the picture and sound intermediate frequencies, respectively, in the television receiver. The picture and sound if signals are coupled from the plate of the mixer to the if stages of the receiver.

When the multiple-section channel selector is rotated to the U position (for uhf operation), a connection from the B+ line of the vhf tuner through a 5600-ohm dropping resistor, contacts 4 and 10 of  $S_{1A}$ , and a 4700-ohm dropping resistor provides the B+ voltage for the uhf tuner. In addition, transformer  $T_2$ , which provides the input to the rf amplifier, is connected through contacts 2 and 13 of  $S_{1B}$  to the output of the uhf tuner, and the signal from the vhf antenna is shorted to ground

through contacts U and 12 of  $S_{1A}$ . The input to the rf amplifier is then the amplitude-modulated 45.75-MHz picture if and frequency-modulated 41.25-MHz sound if signals from the uhf tuner.

In the U positions, switch sections  $S_2$  and  $S_3$  select the tuning inductors required for operation of the rf amplifier and mixer stages as broadband 44-MHz amplifiers, and section  $S_4$  disables the oscillator stage by connection of the oscillator control grid directly to ground through switch contacts 2 and U. With these changes, the vhf tuner essentially becomes a broadband 44-MHz amplifier which provides two stages of amplification of the picture and sound if signals ahead of the receiver main if strip.

For Black-and-White Television Receiver

### Circuit Description

These circuit stages are typical of those used in the if and audio channels of any intercarrier type of black-and-white television receiver. The over-all circuit operates from a dc supply of +150 volts obtained from the receiver low-voltage (B+) dc power supply. The heaters of the tubes in the circuit are connected in series with those of tubes in other sections of the receiver. Operating power for the series heater string is obtained directly from the 117-volt ac power line.

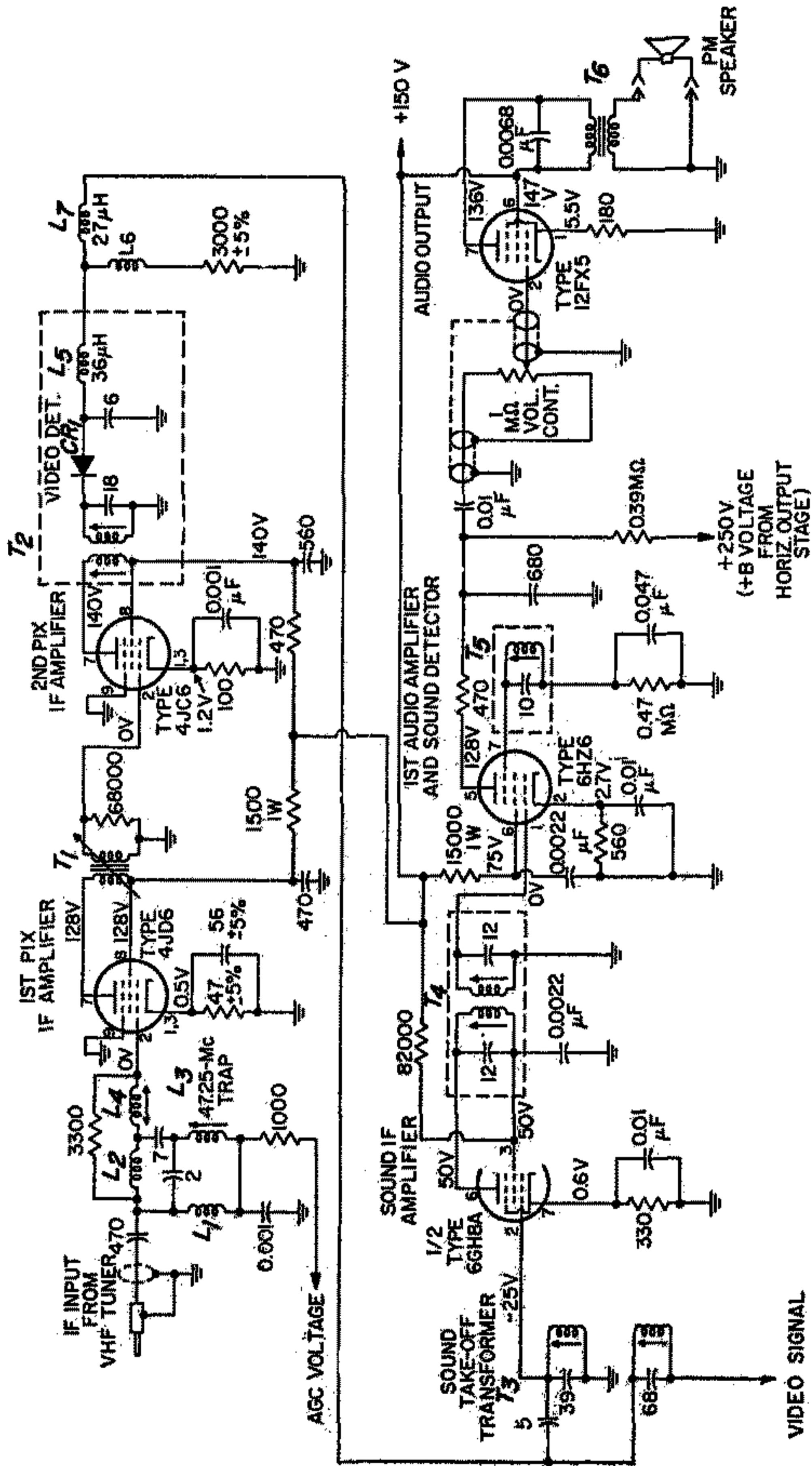
The input from the vhf tuner consists of amplitude-modulated 45.75-MHz picture if signals and frequency-modulated 41.25-MHz sound if signals. This composite input is coupled by a broadly tuned bandpass filter network to the control grid of the 4JD6 remote-cutoff pentode used in the first picture if amplifier. A dc

bias voltage proportional to the input signal from the age amplifier is also applied to the control-grid circuit to provide automatic gain control of this stage. The output of the first picture if amplifier is coupled by the single-tuned transformer  $T_1$  to the control grid of the 4JC6 pentode used in the second picture if amplifier. The double-tuned transformer  $T_2$  couples the output of this stage to the video detector ( $CR_1$  and associated components). The input filter network and picture if transformers  $T_1$  and  $T_2$  are stagger tuned to obtain the broad response for the if amplifiers required to assure adequate passage of both the 45.75-MHz video and 41.25-MHz sound if signals.

The video detector demodulates the 45.75-MHz picture if signal, and the resultant video signal is coupled

through inductors  $L_6$  and  $L_7$  and the lower winding of transformer  $T_3$  to the video amplifier (shown in circuit 25-28). The video detector also operates as a second mixer circuit. The 45.75-MHz picture if signal and the 41.25-MHz sound if signal are heterodyned to produce a second sound if carrier of 4.5 MHz. This 4.5-MHz second sound if carrier is still frequency-modulated by the audio components contained in the original rf signal input at the receiver antenna. The sound-takeoff transformer  $T_3$ , which forms a selective load impedance for the detector circuit at 4.5 MHz, couples the 4.5-MHz sound if signal to the control grid of the pentode section of a 6GH8A triode pentode used in the sound if amplifier. The amplified if signal from this stage is coupled by the doubled-tuned 4.5-MHz transformer  $T_4$  to the

25-27 VIDEO-IF AMPLIFIERS AND SOUND-CHANNEL CIRCUITS (Cont'd)





- CR<sub>1</sub> = Video detector, crystal diode, RCA Stock No. 112524 or equiv.  
 L<sub>1</sub> = RF coil, RCA Stock No. 114315 or equiv.  
 L<sub>2</sub> = RF coil, RCA Stock No. 114314 or equiv.  
 L<sub>3</sub> = RF coil, 47.25-MHz trap RCA Stock No. 113097 or equiv.  
 L<sub>4</sub> = RF coil, RCA Stock No. 113097 or equiv.  
 L<sub>5</sub> = Video-detector peaking coil, 36  $\mu$ H, RCA Stock No. 109758 or equiv.  
 L<sub>6</sub> = Video-detector peaking coil, 560  $\mu$ H, RCA Stock No. 114488 or equiv.  
 L<sub>7</sub> = Filter choke (reactor), 2.7  $\mu$ H; RCA Stock No. 107463 or equiv.  
 T<sub>1</sub> = First pix if transformer, RCA Stock No. 109158 or equiv.  
 T<sub>2</sub> = Second pix if transformer, RCA Stock No. 114317 or equiv.  
 T<sub>3</sub> = Sound take-off transformer, 4.5-MHz, RCA Stock No. 114489 or equiv.  
 T<sub>4</sub> = Sound if transformer (includes primary and secondary capacitors), RCA Stock No. 104137 or equiv.  
 T<sub>5</sub> = Sound detector resonant circuit (includes 10-pF capacitor), RCA Stock No. 109948 or equiv.  
 T<sub>6</sub> = Audio output transformer, matches speaker voice-coil impedance to tube plate load, RCA Stock No. 114490 or equiv.

- Notes: 1. Resistance in ohms and capacitance in microfarads unless otherwise specified.  
 2. All resistors 0.5 watt unless otherwise specified.  
 3. Voltages shown are obtained with no signal input.  
 4. For dc voltage and heater supply, see circuit 25-30, page 596.  
 5. See additional notes on page 580.

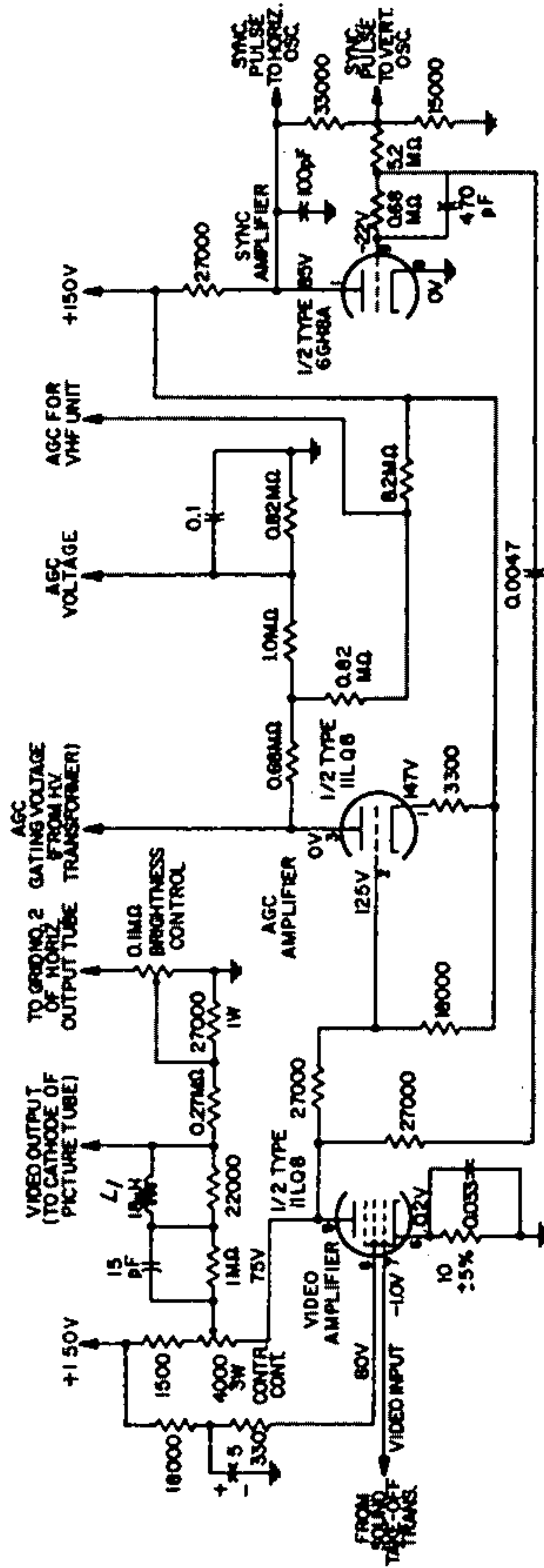
### Circuit Description (Cont'd)

6HZ6 audio detector-amplifier stage. This stage demodulates the 4.5-MHz sound if signal and amplifies the resultant audio signal voltage. The +250 volts used as the plate supply for the 6HZ6 is obtained from the horizontal output stage (shown in

circuit 25-29) of the receiver. The audio-signal power required to drive the speaker is developed by a 12FX5 pentode used in a single-ended audio output stage. The audio-signal voltage from the plate of the audio detector-amplifier is amplified

by the 12FX5 and coupled by transformer T<sub>6</sub> to the voice coil of the speaker. The volume-control potentiometer in the input circuit of the output stage provides manual adjustment of the sound level from the speaker.

**25-28 VIDEO, AGC, AND SYNC AMPLIFIERS**  
For Black-and-White Television Receiver



L<sub>1</sub> = Video-amplifier peaking coil, 18 μH, RCA Stock No. 109946 or equiv.

Notes: 1. Resistance in ohms and capacitance in microfarads unless otherwise specified.

2. All resistors 0.5 watt unless otherwise specified.

3. Voltages shown are obtained with no signal input.

4. For dc voltage and heater supply, see circuit 25-30, page 596.

5. See additional notes on page 580.

### Circuit Description

This circuit shows video, agc, and sync amplifiers for a black-and-white television receiver. The video and sync amplifiers operate from a plate supply (B+) voltage of 150 volts obtained from the receiver low-voltage power supply. The plate supply voltage for the agc amplifier is a positive keying pulse from the high-voltage transformer in the receiver. The heaters of the three tubes are connected in series with those of tubes in other sections of the receiver. Operating power for the series heater string is obtained directly from the ac power line.

In the video amplifier, the pentode section of an 11LQ8 triode-pentode provides the required amplifica-

tion of the video signal. The video signal is coupled from the video detector to the control grid of the video amplifier. The output from the voltage divider in the plate circuit of this stage is applied to the cathode of the picture tube to intensity-modulate the electron beam during its vertical and horizontal scanning of the picture-tube screen. The contrast control adjusts both the amplitude of the video output and the dc potential at the cathode of the picture tube to control picture contrast. The voltage-divider network in the plate circuit of the video amplifier is interconnected with another voltage-divider network. This second network includes the bright-

ness control and the width control in the screen-grid circuit of the receiver horizontal-output tube (shown in circuit 25-29). The brightness control adjusts the cathode bias on the picture tube to control the intensity of the screen display.

An output from the video amplifier is also applied to the control grid of the 11LQ8 triode section used in a keyed-agc amplifier stage. The operation of the agc amplifier is gated (keyed) by a positive pulse from the high-voltage power transformer (shown in circuit 25-29). This 450-volt keying pulse, which is synchronized with the video signal, overcomes the bias provided by the 150 volts applied to the cathode cir-

**Circuit Description (Cont'd)**

cuit and serves as the plate supply voltage for the agc amplifier. Portions of the video signal that occur coincident with the keying pulse are amplified by the agc stage. A 0.1-microfarad capacitor and a 0.82-megohm resistor in the plate circuit of this stage filter out the pulsating components to obtain a negative dc voltage proportional to the video signal and thus to the rf input at the receiver antenna. The negative voltage developed in the plate circuit of the stage is applied as agc bias to the first picture if amplifier and to the rf amplifier in the vhf tuner.

Synchronizing pulses are included in the video signals transmitted by a television broadcast station to provide timing information required for synchronization of the transmitter and receiver scanning systems. The sync amplifier, or separator, separates and amplifies the synchronizing pulses contained in the composite video signal it receives from the plate circuit of the video amplifier. The circuit uses the triode section of a 6GH8A triode-pentode to develop the synchronizing pulses for the vertical- and horizontal-deflection circuits of the re-

ceiver. The sync amplifier is basically a class C limiter stage. With the video signal applied, the stage is biased beyond cutoff by the grid-leak bias network formed by the 470-picofarad capacitor and the 0.68-megohm resistor in the control-grid circuit. Only the sync pulses in the composite video signal have sufficient amplitude to drive the sync amplifier into conduction. The resultant pulses developed across the output voltage-divider network are used as the synchronizing inputs to the horizontal- and vertical-deflection circuits.



## VERTICAL- AND HORIZONTAL-DEFLECTION CIRCUITS AND HIGH-VOLTAGE RECTIFIER

For Black-and-White Television Receiver

### Circuit Description

These circuits develop the vertical and horizontal scanning signals and the dc operating potentials for the picture tube (RCA Type 16BGP4) used in the black-and-white television receiver and the boosted B+ voltage (+250 volts) used in the audio detector-amplifier (part of circuit 25-28). The circuits operate from a dc supply of 150 volts. With the exception of the 1G3GT (or 1B3GT) high-voltage rectifier tube, the heaters of the various tubes are connected in series with those of tubes in other sections of the receiver and are supplied by the input ac power line. Heater power for the 1G3GT (or 1B3GT) is provided by a 1.25-volt winding of the high-voltage transformer T<sub>1</sub>.

The vertical- and horizontal-deflection circuits are synchronized by negative signals from the sync amplifier (separator) which include horizontal sync pulses, equalizing

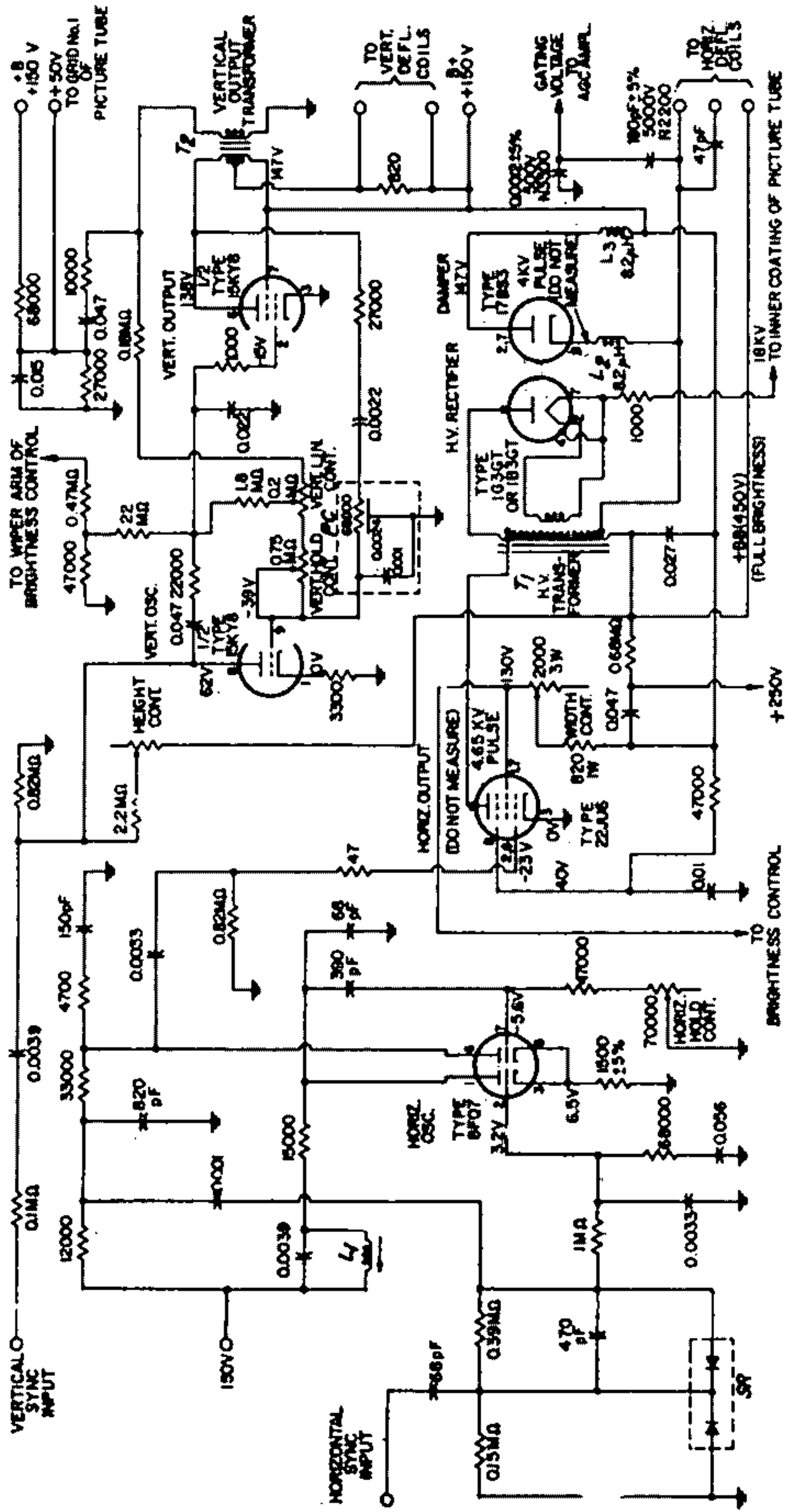
pulses, and vertical sync pulses. When the composite video signal is generated at the television broadcast station, the leading edge of each horizontal sync pulse, of alternate equalizing pulses, and of alternate serrations of the vertical sync pulses are correctly timed to initiate the horizontal-retrace period. It is necessary, therefore, to extract the leading-edge components from the combined sync waveform prior to application of the synchronizing input to the horizontal-deflection circuit. Similarly, the vertical sync pulses must be separated from the combined waveform before they can be used to synchronize the vertical-deflection circuit.

The combined sync waveform is differentiated at the input to the horizontal-deflection circuit to obtain negative and positive voltage spikes which correspond to the leading and lagging edges, respectively, of the

rectangular sync pulses. The amplitude of these voltage spikes is dependent upon only the peak value of the sync pulses and is not affected by the time durations of these pulses. The differentiating circuit, therefore, does not respond to the flat portions of the vertical sync pulses, and, with the exceptions of the serrations, the vertical sync pulses do not affect the operation of the horizontal-deflection circuits. The leading edge of alternate serrations, however, corresponds to the start of horizontal-retrace periods and thus may be considered as merely another horizontal sync signal.

The differentiated sync waveform is applied to the junction of the twin silicon diodes SR used in a phase-discriminator network. The positive portion of the differentiated waveform has no effect on the discriminator network. The negative portion is compared with a feedback

25-29 VERTICAL- AND HORIZONTAL-DEFLECTION CIRCUITS AND HIGH-VOLTAGE RECTIFIER (Cont'd)



## VERTICAL- AND HORIZONTAL-DEFLECTION CIRCUITS AND HIGH-VOLTAGE RECTIFIER (Cont'd)

$L_1$  = Oscillator coil, RCA Stock No. 114486 or equiv.  
 $L_2$   $L_3$  = RF chokes (reactors), 8.2  $\mu$ H, RCA Stock No. 107385 or equiv.  
 PC = Printed circuit (includes 0.001- $\mu$ F

and 0.0024- $\mu$ F capacitors and 68000-ohm resistor), RCA Stock No. 114506 or equiv.  
 SR = Selenium rectifier, RCA Stock No. 109474 or equiv

$T_1$  = High-voltage and horizontal-output transformer, RCA Stock No. 114498 or equiv.

$T_2$  = Vertical-output transformer, RCA Stock No. 114502 or equiv.

- Notes:** 1. Resistance in ohms and capacitance in microfarads unless otherwise specified.  
 2. All resistors 0.5 watt unless otherwise specified.  
 3. Voltages shown are obtained with no signal input.  
 4. For dc voltage and heater supply, see circuit 25-30 page 596.  
 5. See additional notes on page 580.

### Circuit Description (Cont'd)

signal from the horizontal oscillator to derive the synchronizing voltage. The frequency of the horizontal oscillator and the repetition rate of the horizontal sync pulses should both be 15,750 Hz, the desired horizontal scanning rate for the picture tube. If the feedback signal from the oscillator does not occur coincident with the horizontal sync pulse, the phase discriminator develops a dc error voltage at the control grid of the input section of the 8FQ7 twin triode used in the oscillator stage. The resultant change in oscillator

bias shifts the phase of the oscillator signal until it is locked in phase with the horizontal sync pulse.

The horizontal oscillator is basically a cathode-coupled multivibrator that free-runs, in asymmetrical half cycles, at a frequency of 15,750 Hz. A parallel LC circuit connected in series with the plate of the input section resonates at 15,750 Hz to provide frequency stabilization for the horizontal oscillator. The HOLD control adjusts the basic multivibrator frequency to achieve an exact lock-

in with the horizontal sync pulses. In a cathode-coupled multivibrator, one amplifier section conducts at saturation and the other section is cut off during one half-cycle of operation, and these states are automatically reversed for the next half cycle. Such circuits normally provide rectangular-wave outputs from each plate section that are 180 degrees out of phase and that switch between the saturation plate voltage and  $B+$  (i.e., the cutoff plate voltage).

## VERTICAL- AND HORIZONTAL-DEFLECTION CIRCUITS AND HIGH-VOLTAGE RECTIFIER (Cont'd)

### Circuit Description

In the horizontal oscillator a series RC network is connected in parallel with the output tube section. Because of this network, the plate voltage does not immediately rise to the  $B+$  value when the output tube section is cut off. Instead, there is a small immediate rise in plate voltage that results from the voltage drop across the resistor in the output RC network produced by the initial charging current to the capacitor. The plate voltage then rises gradually at a rate determined by the long-time-constant circuit through which the capacitor is charged. Before the capacitor can fully charge to the  $B+$  voltage, the combination of the horizontal sync input and the feedback signal from the plate of the output section of the oscillator drives the grid of the input section below cutoff. The instantaneous rise in the plate voltage of the input section is coupled to the grid of the output section and causes this sec-

tion to conduct. The capacitor in the output RC network is then quickly discharged through the series resistor and the relatively low resistance of the output tube section. The output of the horizontal oscillator, therefore, is a trapezoidal voltage wave. The rising-slope portions of this wave (obtained when the output tube section is cut off) correspond to the horizontal-trace period on the picture tube; the discharge portion of the trapezoidal wave corresponds to the retrace period. The time-constant coupling circuits between the input and output sections of the oscillator are designed so that the retrace period represents only about 5 to 10 per cent of the over-all oscillator cycle.

The trapezoidal voltage wave is coupled to the control grid of the 22JU6 pentode horizontal-output stage and causes a sawtooth current to flow through the high-voltage (flyback) transformer  $T_1$  and through

the horizontal-deflection coils of the picture tube. The gradually rising portion of the sawtooth current causes the horizontal scanning of the picture tube; the more rapid negative-slope portion of the current wave causes the retrace. During the retrace period, the picture-tube screen is blanked by a negative pulse applied to the control grid of the picture tube from the vertical-deflection circuits. The WIDTH control in the screen grid of the horizontal-output stage adjusts the gain of this stage to control the width of horizontal scanning.

The vertical oscillator employs a 15KY8 triode-pentode in a basic plate-coupled multivibrator configuration. This free-running 60-Hz multivibrator is synchronized by the vertical sync pulses. The vertical pulses are separated from the combined sync waveform by integration of the combined waveform across the 0.022-microfarad capacitor in the control-



## VERTICAL- AND HORIZONTAL-DEFLECTION CIRCUITS AND HIGH-VOLTAGE RECTIFIER (Cont'd)

### Circuit Description (Cont'd)

grid circuit of the pentode output section of the multivibrator. The integrating network has negligible response for the narrow horizontal sync and equalizing pulses, but responds to the greater energy included in the much wider vertical sync pulses to develop a triangular voltage wave at the control grid of the pentode output section. The VERT LIN potentiometer adjusts the charging period of the integrating capacitor to control vertical linearity. The VERT HOLD adjusts the frequency of the multivibrator to achieve an exact lock-in with the vertical sync pulses.

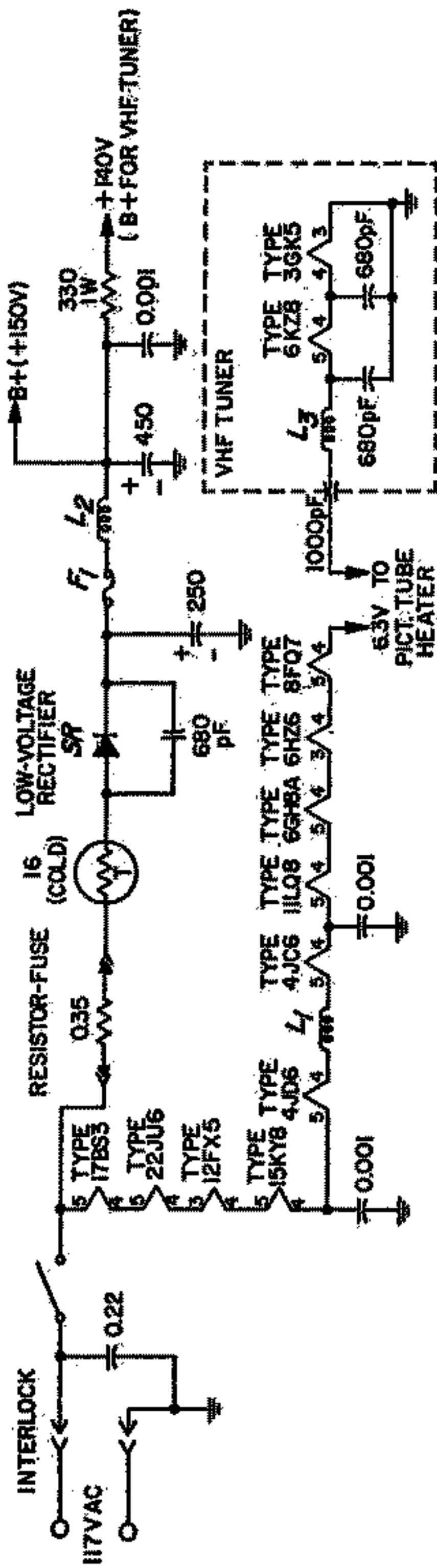
The voltage waveform at the control grid of the pentode output section results in a triangular wave of current through the vertical-output transformer  $T_2$  and through the vertical-deflection coils of the picture tube. The rising portion of the triangular current wave produces the vertical scanning, and the decreasing portion of the wave provides the

retrace. Blanking pulses to cut off the picture tube during vertical and horizontal retrace periods are coupled from the secondary of  $T_1$  and from the VERT LIN potentiometer (combined sync waveform before integration) to the control grid of the picture tube.

The 1G3GT (or 1B3GT) half-wave rectifier circuit develops the dc operating voltages for the picture tube. The ac input power to the rectifier is supplied by the horizontal-deflection circuits. The sudden cutoff of plate current in the horizontal-output stage at the beginning of the retrace period causes a very large, positive-going voltage pulse to be generated across the high-voltage transformer  $T_1$ . The rectifier converts this voltage pulse to a dc output voltage of approximately 18,000 volts, which is applied to the inner coating of the picture tube. Removal of negative overshoots that would be developed across the high-voltage transformer because of a

flywheel effect is accomplished by connection of a rectifier (damper) tube across the horizontal-deflection coils which are in parallel with the lower tapped section of the high-voltage transformer. The polarity of the damper tube is such that the positive pulse developed across the high-voltage transformer causes no current flow through it. For negative pulses, however, the damper tube provides a low-impedance path for the current, and energy stored in the horizontal-deflection coils during the preceding half-cycle is dissipated as heat at the damper-tube plate to prevent oscillation in the coils. The current through the damper tube develops a dc voltage of 450 volts across the 0.027-microfarad capacitor in the cathode circuit. The 0.68-megohm dropping resistor reduces this voltage to obtain the boosted B+ of 250 volts required for operation of the audio detector-amplifier (part of circuit 25-27).

**25- LOW-VOLTAGE AND HEATER SUPPLY**  
For Black-and-White Television Receiver



$L_1$  = RF choke, part of heater printed-circuit board, RCA Stock No. 114499 or equiv. (includes two 0.001- $\mu$ F capacitors)  
 $L_2$  = Filter choke (reactor), RCA Stock No. 1501 or equiv.  
 $L_3$  = Rr choke for VHF tuner filament circuit  
 Resistor-fuse = 0.35-ohm, RCA Stock No. 114481 or equiv.  
 SR = Silicon rectifier, Type 1N3194  
 Thermistor (T) = Surge-protection resistor, 16 ohms (cold), RCA Stock No. 114480 or equiv.

Notes: 1. Resistance in ohms and capacitance in microfarads unless otherwise specified.  
 2. See additional notes on page 580.

**Circuit Description**

This circuit includes the low-voltage (+150-volt) dc power supply and the series heater connections for circuits 25-26 through 29. As mentioned previously, the power supply and these four circuits comprise a complete black-and-white television receiver, with the exception of the picture tube and the vertical- and horizontal-deflection yokes.

The power supply is a half-wave type which uses a 1N3194 silicon rectifier. The 117-volt ac input is connected to the power supply through an interlock,  $S_1$ , which may be mounted on the back cover of the receiver. AC input power is then automatically disconnected from the receiver when the back cover is removed. ON-OFF switch  $S_2$  controls the application of ac power to the power-supply circuit and to the tube heaters. With  $S_1$  and  $S_2$  both closed,

the 117-volt power from the ac power line is applied to the series heater network and to the 1N3194 rectifier circuit. Two 0.001-microfarad and two 680-picofarad bypass capacitors and rf chokes  $L_1$  and  $L_2$  are included in the heater circuit to filter out any stray high-frequency signals that may be coupled from the rf and if signal channels.

The 117-volt ac input is converted to pulsating dc by the 1N3194 silicon rectifier. A capacitor-input, pi-type LC filter network filters the rectifier output to obtain a smooth dc voltage that approaches the peak value of the input ac voltage. The 680-picofarad capacitor in parallel with the 1N3194 rectifier and the thermistor in series with it provide surge-current protection for the rectifier. Initial surges of current that may result when power is first applied to the circuit (before a charge

is developed across the input filter capacitor) are partially bypassed by the 680-picofarad capacitor and are limited in magnitude by the cold resistance of the thermistor. The thermistor has a negative temperature coefficient of resistance, and by the time the charge of the input capacitor builds up sufficiently to limit the current through the rectifier to a safe value, the resistance of the heated thermistor is small enough so that circuit power losses across this device are negligible. The resistor-fuse element in series with the 1N3194 rectifier provides protection against any continuous circuit overload. The +150-volt output from the power-supply filter network is used as the main  $B+$  voltage for the television receiver. The 330-ohm, 1-watt dropping resistor at the output of the filter network reduces this voltage to the +140 volts required as the  $B+$  voltage in the vhf tuner.

# INDEX

	<i>Page</i>		<i>Page</i>
Absolute Maximum System of Ratings	91	Automatic Frequency Control (AFC) ..	74
AC/DC Superheterodyne Receiver .....	522	Automatic Gain Control (AGC) .....	46, 48
Admittance, Input .....	27	Automatic Volume Control (AVC) .....	46
All-Purpose Power Supply .....	578		
AM Detection .....	19	<b>Bass and Treble Tone-Control</b>	
AM/FM Receiver .....	524	Amplifier Stage .....	564
Amplification .....	24	Beam Power Tubes .....	9
Amplification Factor ( $\mu$ ) .....	13	<b>Bias:</b>	
<b>Amplifier:</b>		battery .....	82
audio-frequency .....	15, 24	cathode (self) .....	82
audio mixer, circuit .....	556	diode .....	21
cathode-drive .....	37	grid-resistor .....	22, 83
cathode-follower .....	38, 40	Burst .....	60, 71
class A .....	25, 28	Bypassing .....	82
class AB .....	25, 34		
class AB <sub>1</sub> .....	34	<b>Calculation of:</b>	
class AB <sub>2</sub> .....	37	amplification factor .....	13
class B .....	25, 37	cathode (self-bias) resistor .....	82
class C .....	25	cathode load resistor .....	42
high-fidelity .....	49, 88	control-grid-plate transconductance .	14
intermediate-frequency, circuit .....	534	filament resistor power dissipation .	80
limiter .....	50	filament (or heater) resistor value .	80
luminance .....	60	gain-bandwidth product .....	57
parallel .....	28	harmonic distortion .....	30, 32
phase-inverter .....	51	heater warm-up time .....	79
preamplifier, circuits .. 558, 560, 562, 563		load resistance .....	31, 35
push-pull .....	28, 31	noise figure .....	55
radio-frequency .....	25, 52	operating conditions from	
remote-cutoff .....	27, 56	conversion nomograph .....	32
resistance-coupled .....	26	peak inverse plate voltage .....	93
sync .....	61	plate efficiency .....	14
television .....	56	plate resistance .....	13
tone-control .....	45	power output .....	29, 35
tone-control, circuit .....	564	power sensitivity .....	14
video .....	58, 60	Q (selectivity) .....	52
voltage .....	25	resonant frequency .....	52
volume-expander .....	50	screen-grid voltage dropping resistor	95
<b>Amplifiers:</b>		transconductance .....	14, 41
if .....	52	voltage amplification (gain) .....	26, 40
tuned .....	52	<b>Capacitive Division</b> .....	54
wideband .....	58	<b>Capacitor-Input Filter</b> .....	87
<b>Amplitude Modulation (AM)</b> .....	19	<b>Cathode:</b>	
<b>Anode</b> .....	5	bias .....	82
<b>Application Guide for RCA</b>		bypassing .....	82
Receiving Tubes .....	97	connection .....	81
<b>Arc-Back Limit</b> .....	93	current .....	81
<b>Audio Mixer</b> .....	556	directly heated .....	3
<b>Audio Signal Generator</b> .....	566	drive .....	37



	<i>Page</i>		<i>Page</i>
follower .....	38, 40	Code-Practice Oscillator .....	538
indirectly heated .....	4	Color Demodulation .....	69
ionic-heated .....	6	Color Picture Tubes .....	13
resistor .....	82	Color Television .....	60
types .....	3	Communications Transceiver .....	16
Cathode-Ray Oscilloscope .....	574	Contact Potential .....	84
Characteristic Curves, Interpretation of .....	94	Conversion Nomograph, Use of .....	32
Characteristics:		Conversion Transconductance .....	14
amplification factor .....	13	Corrective Filter .....	43
control-grid-plate transconductance .....	14	Cross-Modulation .....	27
conversion transconductance .....	14	Current:	
dynamic .....	13	cathode .....	81
plate resistance .....	13	dc output .....	92
static .....	13	grid .....	84
Charts and Tables:		peak plate .....	93
grid-No.2 input rating chart .....	96	plate .....	5
picture tube characteristics chart .....	495	Curves, Interpretation of Characteristic .....	94
outline drawings .....	513	Cutoff .....	27
resistance-coupled amplifier .....	504		
types for replacement use .....	448	Dark Heater .....	4
Choke-Input Filter .....	87	Deflection Circuits:	
Chrominance Channel .....	61	horizontal .....	66
Circuit Diagram of:		vertical .....	68
ac/dc superheterodyne radio receiver .....	522	Degeneration (See Inverse Feedback) .....	38
all-purpose power supply .....	578	Delayed Automatic Volume Control	
AM/FM superheterodyne radio		(DAVC) .....	47
receiver .....	524	Demodulation .....	19, 69
audio signal generator .....	566	Design-Center System of Ratings .....	91
bass and treble tone-control		Design-Maximum System of Ratings ...	91
amplifier .....	564	Detection:	
cathode-ray oscilloscope .....	574	AM .....	19
citizens-band transceiver .....	540	diode .....	20
code practice oscillator .....	538	discriminator .....	23
electronic volt-ohm meter .....	570	FM .....	22
FM stereo multiplex adapter .....	531	grid bias .....	21
FM tuner .....	528	grid resistor and capacitor .....	22
high-fidelity, 15-w audio amplifier .....	546	ratio detector .....	24
high-fidelity, 30-w audio amplifier .....	548	synchronous .....	70
high-fidelity, 50-w audio amplifier .....	550	Diode:	
intercommunication set .....	544	biasing .....	21
low-distortion preamplifier .....	563	considerations .....	5
low-voltage and heater supply		detection .....	20
(for tv receiver) .....	596	Discriminator .....	23
microphone and phonograph		Dress of Circuit Leads .....	86
amplifier .....	554	Dynamic Characteristics .....	13
phonograph amplifier .....	557		
preamplifier for amateur receiver .....	536	Electron:	
preamplifier for ceramic		considerations .....	3
phonograph-pickup .....	562	secondary .....	8, 9
preamplifier for magnetic		Electronic Volt-Ohm Meter .....	570
phonograph-pickup .....	558	Electrons, Electrodes, and Electron	
preamplifier for tape-head pickup .....	560	Tubes .....	3
three-stage if amplifier/limiter		Electron Tube Application .....	15
and ratio detector .....	534	Electron Tube Characteristics .....	13
two-channel audio mixer .....	556	Electron Tube Installation .....	79
two-channel, 1-w stereo amplifier .....	552	Electron Tube Testing .....	500
vertical and horizontal deflection		Electron-Ray Tubes .....	77
circuits and high-voltage rectifier		Emission:	
video, agc, and sync amplifiers ...	588	current .....	5
video if amplifiers and sound-channel		secondary .....	8, 9
circuits .....	585	test .....	501
vhf tuner .....	581	Feedback, Inverse .....	25, 38
Citizens-Band Transceiver .....	540		

	<i>Page</i>		<i>Page</i>
Filament (also see Heater and Cathode):		Intercommunication Set .....	544
operation .....	3, 79	Interelectrode Capacitances .....	7, 94
resistor .....	80	Intermodulation Distortion .....	49
series operation .....	80	Interpretation of Tube Data .....	91
shunt resistor .....	80	Inverse Feedback:	
supply voltage .....	79	constant-current type .....	40
Filter:		constant-voltage type .....	38
capacitor-input .....	87	Key: Basing Diagrams, Inside Back Cover	
choke-input .....	87	Kinescopes .....	10
corrective .....	43	Limiters .....	50
radio-frequency .....	87	Load resistance .....	31
smoothing .....	87	Local Oscillator .....	57
FM Detection .....	22	Low-Distortion preamplifier .....	563
FM Stereo Multiplex Adapter .....	531	Luminance Amplifier .....	60
FM Tuner .....	528	Maximum Ratings .....	91
Formulas (see Calculation)		Mercury-Vapor Rectifier:	
Frame Grid .....	7	considerations .....	6
Frequency Conversion .....	75	interference from .....	87
Frequency Modulation (FM) .....	22	Mho-micromho .....	14
Full-Wave Rectifier .....	5, 17	Microphone and Phonograph Amplifier ..	554
Gain (Voltage Amplification) .....	26	Mixer:	
General System Functions .....	15	audio .....	556
Generic Tube Types .....	4	hexode .....	77
Grid:		pentagrid .....	77
bias .....	83	vhf tuner .....	56
bias detection .....	21	Modulated Wave .....	19
control .....	6, 7	Modulation .....	19
current .....	84	Modulation-Distortion .....	27
resistor .....	83	Multi-Electrode and Multi-Unit Tubes ..	9
resistor and capacitor detection ..	22	Multiplex Adapter for FM Stereo .....	531
screen .....	7	Multivibrator .....	72
suppressor .....	8	Noise .....	54
voltage supply .....	82	Noise Figure .....	55
Grid-Plate Capacitance .....	7	Noise Immunity .....	65
Grid-Plate Transconductance .....	14	Novar .....	10
Half-Wave Rectifier .....	5, 17	Novar Tube, Parts of .....	2
Harmonic Distortion .....	30, 49	Novistor .....	10
Heater:		Operation, Typical Values .....	94
cathode .....	4	Oscillator:	
cathode bias .....	81	considerations .....	72
cathode connection .....	81	local .....	57
resistor .....	80	multivibrator .....	72
series operation .....	80	relaxation .....	72
shunt resistor .....	80	synchroguide .....	73
supply voltage .....	79	Oscilloscope .....	574
warm-up time .....	91	Output Capacitance .....	94
Hexode Mixer .....	77	Output-Coupling Devices .....	88
High-Fidelity Amplifiers .....	49, 88	Parallel Operation .....	28,
High-Fidelity, 15-w Audio Amplifier ...	546	Peaking:	
High-Fidelity, 30-w Audio Amplifier ...	548	series .....	58
High-Fidelity, 50-w Audio Amplifier ...	550	shunt .....	58
High-Voltage Regulations .....	69	Peak Inverse Plate Voltage .....	93
Horizontal Deflection .....	66	Peak Plate Current .....	93
Hum and Noise Characteristics .....	94	Pentagrid Converter .....	9
IF Amplifier/Limiter and Ratio Detector	534	Pentagrid Mixer .....	77
Impedance, Input .....	27	Pentode Considerations .....	8
Injection Voltage .....	56	Phase Inverter .....	51
Input Admittance .....	27	Phonograph Amplifier .....	557
Input Capacitance .....	94		
Instantaneous Peak Voltage .....	93		

	<i>Page</i>		<i>Page</i>
Phonograph and Tape Preamplifiers ...	43	filament .....	80
Picture Tube:		plate load .....	31
characteristics chart .....	495	screen-grid .....	85, 95
corona considerations .....	90	Resonant Circuits .....	52
deflection .....	10	Saturation Current .....	5
dust considerations .....	90	Scanning Fundamentals .....	61
essential elements .....	10	Screen Grid (Grid No.2):	
handling precautions .....	90	considerations .....	7
high-voltage considerations .....	89	input .....	95
humidity considerations .....	89	voltage supply .....	84
safety considerations .....	90	Secondary Electrons .....	8, 9
screen .....	10	Secondary Emission .....	8
structure .....	10	Selectivity (Q) .....	52
x-ray radiation precautions .....	90	Self Bias (cathode bias) .....	82
Plate:		Shielding .....	85
current .....	5	Short-Circuit Test .....	500
dissipation .....	92	Signal Generator .....	566
efficiency .....	14	Signal-to-Noise Ratio .....	54
load .....	21	Space Charge .....	5, 9
resistance .....	13	Static Characteristics .....	13
voltage supply .....	81	Stereo Circuits .....	531, 552
Plate-Cathode Capacitance .....	7, 94	Superheterodyne Receiver (ac/dc) ....	522
Power Output:		Suppressor Grid (Grid No.3) .....	8
calculations .....	29	Sync .....	62
test .....	500	Sync Circuits .....	62
Power Sensitivity .....	14	Sync Separator .....	63
Power Supply .....	578	Synchroguide .....	73
Preamplifier for Amateur Receiver ....	536	Synchronous Detection .....	70
Preamplifier for Ceramic Phonograph		Technical Data for Tube Types .....	105
Pickup .....	562	Television:	
Preamplifier for Magnetic Phonograph		color demodulation .....	69
Pickup .....	558	horizontal deflection .....	66
Preamplifier for Tape-Head Pickup ...	560	if amplifiers .....	57
Preamplifiers, Phonograph and Tape ...	43	picture tubes .....	10, 89
Push-Pull Operation .....	28, 31	receiver .....	16
Q (selectivity) .....	52	rf amplifiers .....	56
Radio-Frequency:		scanning .....	81
amplifier .....	25, 52	sync circuits .....	62
filter .....	87	vertical deflection .....	68
Radio Receiver .....	15	Testing Electron Tubes .....	500
Ratings:		Tetrode Considerations .....	7
absolute-maximum system .....	91	Three-Stage IF Amplifier/Limiter	
design-center system .....	91	and Ratio Detector .....	534
design-maximum system .....	91	Tone-Control Amplifier Stage .....	564
Ratio Detector .....	24	Tone Control .....	45
Rectification .....	17	Transceiver, Citizens-Band .....	540
Rectifiers:		Transconductance:	
full-wave .....	5, 17	conversion .....	14
half-wave .....	5, 17	grid-plate .....	14
ionic-heated cathode .....	6	test .....	501
parallel operation of .....	18	Triode Considerations .....	6
plate-characteristics curves .....	94	Tube:	
voltage doubler .....	18	outlines .....	513
Relaxation Oscillator .....	72	ratings, interpretation of .....	91
Remote-Cutoff Tubes .....	27	tester requirements .....	502
Resistance-Coupled Amplifiers .....	26	Tube Types, Technical Data .....	105
Resistance Coupling .....	26	Tuned Amplifiers .....	52
Resistor:		Tuner, FM .....	528
cathode (self-biasing) .....	82	Tuners, Television .....	56
center tap .....	80	Tuning Indicators .....	77
		TV Scanning, Sync, and Deflection ....	61

	<i>Page</i>		<i>Page</i>
Twin diode—triode .....	20	doubler rectifier .....	18
Two-Channel Audio Mixer .....	556	peak heater-cathode .....	92
Two-Channel Stereophonic Amplifier ...	552	peak inverse plate .....	93
Typical Operation Values, Interpretation of .....	94	supply .....	81
Vertical and Horizontal Deflection Circuits and High Voltage Rectifier	591	Voltage Doubler .....	18
Vertical Deflection .....	68	Volt-Ohm Meter .....	570
Video Amplifiers .....	58, 60	Volume Control:	
Video, AGC, and Sync Amplifiers ....	588	automatic (AVC) .....	46
Video IF Amplifiers and Sound-Channel Circuits .....	585	by grid-voltage variation . . . . .	83
VHF Tuner .....	581	by screen-grid-voltage variation . . . .	85
Voltage:		delayed automatic (DAVC). . . . .	47
amplification, class A .....	15	Volume Compressor and Expander . . . .	50
		Wideband (Video) Amplifiers .....	



# RCA Technical Publications

## on Electron Tubes, Semiconductor Products, and Batteries

**C**OPIES of the publications listed below may be obtained from your RCA distributor or from Commercial Engineering, Radio Corporation of America, Harrison, N. J.

### Electron Tubes

● **RCA ELECTRON TUBE HANDBOOK—HB-3** (7 $\frac{3}{8}$ " x 5 $\frac{3}{8}$ ")—Five 2 $\frac{1}{4}$ -inch-capacity binders. Contains over 7500 pages of looseleaf data and curves on RCA receiving tubes, transmitting tubes, cathode-ray tubes, picture tubes, photocells, phototubes, camera tubes, ignitrons, vacuum gas rectifiers, traveling-wave tubes, premium tubes, pencil tubes, and other miscellaneous types for special applications. Available on subscription basis. Price \$20.00\* including service for first year. Also available with RCA Semiconductor Products Handbook HB-10 at special combination price of \$25.00.\*

● **RADIOTRON® DESIGNER'S HANDBOOK—4th Edition** (8 $\frac{3}{4}$ " x 5 $\frac{1}{2}$ ")—1500 pages. Comprehensive reference covering the design of radio and audio circuits and equipment. Written for the design engineer, student, and experimenter. Contains 1000 illustrations, 2500 references, and cross-referenced index of 7000 entries. Edited by F. Langford-Smith. Price \$7.00.\*†

● **RCA PHOTOTUBE AND PHOTOCCELL MANUAL—PT-60** (8 $\frac{1}{4}$ " x 5 $\frac{3}{8}$ ")—192 pages. Well-illustrated informative manual covering fundamentals and operating considerations for vacuum and gas phototubes, multiplier phototubes, and photocells. Also describes basic appli-

cations for these devices. Features easy-to-use selection chart for multiplier phototubes. Data and performance curves given for over 90 photo-sensitive devices. Price \$1.50.\*†

● **RCA TRANSMITTING TUBES—TT-5** (8 $\frac{1}{4}$ " x 5 $\frac{3}{8}$ ")—320 pages. Gives data on over 180 power tubes having plate-input ratings up to 4 kw and on associated rectifier tubes. Provides basic information on generic types, parts and materials, installation and application, and interpretation of data. Contains circuit diagrams for transmitting and industrial applications. Features lie-flat binding. Price \$1.00.\*†

● **RCA INTERCHANGEABILITY DIRECTORY OF INDUSTRIAL-TYPE ELECTRON TUBES—ID-1020-G** (10 $\frac{7}{8}$ " x 8 $\frac{3}{8}$ ")—12 pages. Lists more than 2500 basic type designations for 22 classes of industrial tube types; shows the RCA Direct Replacement Type or the RCA Similar Type, when available. Single copy free on request.

● **RCA INDUSTRIAL RECEIVING-TYPE TUBES—RIT 104E** (10 $\frac{7}{8}$ " x 8 $\frac{3}{8}$ ")—32 pages. Concise technical data on 225 types used in military, industrial, and commercial equipment. Includes application guide, chart of prototype versus similar RCA industrial types, interchangeability list of domestic versus RCA replacements, terminal diagrams, and socket and connector information. Price 30 cents.\*

● **RCA RECEIVING TUBES AND PICTURE TUBES—1275M** (10 $\frac{7}{8}$ " x 8 $\frac{3}{8}$ ")—56 pages. New, enlarged, and up-to-date booklet contains classification chart, application guide, characteristics chart, and base and envelope connection dia-

grams on more than 1300 entertainment receiving tubes and picture tubes. Price 40 cents.\*

● **RCA INTERCHANGEABILITY DIRECTORY OF FOREIGN vs. U.S.A. RECEIVING-TYPE ELECTRON TUBES—ERT-197E** (8 $\frac{3}{8}$ " x 10 $\frac{7}{8}$ ")—8 pages. Covers approximately 800 foreign tube types used principally in AM and FM radios, TV receivers, and audio amplifiers. Indicates U.S.A. direct replacement type or similar type if available. Price 10 cents.\*

● **RCA PHOTOCELLS—CSS-800** (10 $\frac{7}{8}$ " x 8 $\frac{3}{8}$ ")—36 pages. Contains a selection of photocell-circuit diagrams; technical data and characteristic curves of RCA photoconductive, photojunction, and photovoltaic cells; interchangeability information. Also contains representative circuits. Price 40 cents.\*†

● **RCA NUVISTOR TUBES FOR INDUSTRIAL AND MILITARY APPLICATIONS—ICE-280** (10 $\frac{7}{8}$ " x 8 $\frac{3}{8}$ ")—16 pages. Describes unique features of nuvistors and includes tabular data, dimensional outlines, curves, terminal diagrams, and socket information. Price 25 cents.\*†

● **RCA COMMAND TUBES—RIT-105**—36 pages. Detailed technical data for six "command" types including types 12AT7WA, 5654, 5670, 5751, 5814A, and 6136. These types are interded for use in critical industrial, aircraft, and other equipment requiring exceptional stability and reliability under severe environmental conditions. Price 40 cents.\*

● **RCA NOVAR TUBES—ICE-311**—12 pages. Describes unique features of novar tube types and includes tabular data, dimensional outlines, curves, and terminal diagrams. Single copy free on request.

● **RCA PHOTOMULTIPLIER AND IMAGE TUBES—PIT-700** (10 $\frac{7}{8}$ " x 8 $\frac{3}{8}$ ")—36 pages. Includes concise data on RCA photomultiplier tubes, gas and vacuum photodiodes, sockets and shields for phototubes, and dimensional outlines for photo and image tubes. Price 60 cents.\*

● **PRODUCT GUIDE FOR RCA POWER TUBES—PWR-506A**—32 pages. Contains tabulated data on all RCA power tubes in order of type designation within each general class of service. Includes maximum ratings, temperature ratings, heater or filament requirements, outline drawings, and basing diagrams. Price 15 cents.\*

● **RCA INDUSTRIAL TUBES PRODUCT GUIDE—TPG-200** (10 $\frac{7}{8}$ " x 8 $\frac{3}{8}$ ")—28 pages. Covers all RCA industrial-tube product lines. Gives a brief description of each product line together with quick-selection data. Single copy free on request.

● **RCA POWER TUBES CLASSIFICATION CHARTS—PWR-504**—12 pages. Groups all power tube types by their rated classes of service and lists them in order of power capability. Price 15 cents.\*

● **RCA STORAGE TUBES AND CATHODE-RAY TUBES—STC-900A**—16 pages. Contains technical information on RCA storage tubes, special-purpose kinescopes and oscillograph-type cathode-ray tubes including display-storage tubes, computer-storage tubes, radechons, scan conversion tubes, flying-spot tubes, monitor, projection, transcriber, and view-finder kinescopes; as well as data on fluorescent screens. Price 15 cents.\*

● **RCA TRAVELING-WAVE TUBE CLASSIFICATION CHARTS—MWD-101B**—4 pages. Contains catalog-type data. Single copy free on request.

● **RCA PENCIL TUBE CLASSIFICATION CHARTS—MWD-102A**—4 pages. Contains catalog-type data. Single copy free on request.

● **RCA SOLID-STATE DEVICE CLASSIFICATION CHARTS—MWD-104B**—4 pages. Contains catalog-type data for solid-state microwave devices. Single copy free on request.

● **RCA CAMERA TUBES—CAM-600A**—26 pages. Contains classification charts, defining data and typical characteristic curves for RCA image orthicons and vidicons. Camera tubes recommended

recommended for new equipment design are high-lighted. Price 50 cents.\*

● **TECHNICAL BULLETINS**—Authorized information on RCA receiving tubes, transmitting tubes, and other tubes for communications and industry. Be sure to mention tube-type bulletin desired. Single-copy on any type free on request.

### Semiconductor Products

● **RCA SEMICONDUCTOR PRODUCTS HANDBOOK**—HB-10. Two binders, each 7 $\frac{3}{8}$ " L x 5 $\frac{3}{8}$ " W x 2 $\frac{1}{8}$ " D. Contains over 1000 pages of loose-leaf data and curves on RCA semiconductor devices such as transistors, silicon rectifiers, and semiconductor diodes. Available on a subscription basis. Price \$10.00\* including service for first year. Also available with RCA Electron Tube Handbook HB-3 at special combination price of \$25.00.\*

● **RCA SILICON CONTROLLED RECTIFIER EXPERIMENTER'S MANUAL**—KM-70 (8 $\frac{3}{8}$ " x 5 $\frac{3}{8}$ " )—80 pages. Contains 14 practical and interesting control circuits that can be built with a complement of active devices available in kit form. Includes photographs, schematic diagrams, and descriptive writeups. Also includes brief descriptions of solid-state components used (rectifiers, transistors, SCR's) and short section on troubleshooting. Price 95 cents.\*†

● **RCA TRANSISTOR MANUAL**—SC-12 (8 $\frac{3}{8}$ " x 5 $\frac{3}{8}$ " )—480 pages. Contains up-to-date definitive data on over 630 semiconductor devices including tunnel diodes, silicon controlled rectifiers, varactor diodes, conventional rectifiers, and many classes of transistors. Features easy-to-understand text chapters, as well as tabular data on RCA discontinued transistors. Contains over 40 practical circuits, complete with parts lists, highlighting semiconductor-device applications. Price \$1.50.\*†

● **RCA TUNNEL DIODE MANUAL**—TD-30 (8 $\frac{3}{8}$ " x 5 $\frac{3}{8}$ " )—160 pages. Describes the microwave and switching capabilities of tunnel diodes. Contains

information on theory and characteristics, and on tunnel-diode applications in switching circuits and in microwave oscillator, converter, and amplifier circuits. Includes data for over 40 RCA germanium and gallium arsenide tunnel diodes and tunnel rectifiers. Price \$1.50.\*†

● **RCA SEMICONDUCTOR PRODUCTS GUIDE**—SPG-201A (10 $\frac{3}{8}$ " x 8 $\frac{3}{8}$ " )—20 pages. Contains classification chart, index, and ratings and characteristics on RCA's line of transistors, silicon rectifiers, semiconductor diodes, and photocells. Single copy free on request.

● **RCA SILICON RECTIFIERS**—62S25—6 pages. Describes RCA's line of diffused-junction rectifiers. Includes maximum ratings and characteristics plus rectifier circuit chart which shows voltage and current relationships together with waveforms for single and polyphase rectifier circuits. Single copy free on request.

● **RCA SILICON RECTIFIER INTERCHANGEABILITY DIRECTORY**—ICE-229A—16 pages. Contains replacement information, ratings, characteristics, and physical dimensions for more than 400 silicon and selenium rectifiers. Price 25 cents.\*

● **RCA SILICON POWER RECTIFIERS**—62S10—8 pages. Contains technical data on RCA's line of diffused-junction silicon power rectifiers. Includes quick-selection guide for stud-type and high-voltage "stack" and "stick" type rectifiers. Single copy free on request.

● **RCA DIFFUSED-JUNCTION SILICON RECTIFIER STACKS AND BRIDGES**—SRS-300—10 pages. Contains technical data on RCA's diffused-junction silicon rectifier stacks and bridges. Characteristics of basic rectifier circuits are also given to assist in selection of proper RCA rectifier device. Price 20 cents.\*

● **RCA SMALL-SIGNAL SILICON N-P-N TRANSISTORS**—SST-210—8 pages. Contains technical data on 2N2102 family of silicon transistors including high-voltage types, very-high voltage types,



linear-beta types, and general types. Also includes quick-reference guide. Price 20 cents.\*

### Integrated Circuits

● **RCA LINEAR INTEGRATED CIRCUIT FUNDAMENTALS**—(8¼" x 5¾") 240 pages. Contains basic principals involved in design and application of linear integrated circuits—includes description of silicon monolithic fabrication process—derivation of design equations and performance criteria—schematic diagrams, operating characteristics, and performance data for RCA (multiple-function silicon integrated circuits for a variety of linear applications. Price 2.00\*†

### Batteries

● **RCA BATTERY MANUAL**—BDG-111 (10¾" x 8¾")—68 pages. Contains information on dry cells and batteries carbon zinc, mercury, and alkaline types. Includes battery theory and applications, detailed electrical and mechanical characteristics, a classification chart, dimensional outlines, and terminal connections on each battery type. Price 50 cents.\*†

● **RCA BATTERIES**—BAT-134H (10¾" x 8¾")—36 pages. Technical data on 146 carbon-zinc, alkaline, and mercury batteries for consumer and industrial applications. Includes replacement information for 4000 portable radios, and cross-references 860 domestic battery types to their RCA replacements. Price 35 cents.\*†

### Test and Measuring Equipment

● **INSTRUCTION BOOKLETS** — Illustrated instruction booklets are available for all RCA test instruments at the prices indicated below.

WA-44A (Audio Signal Generator) .....\$0.50\*  
 WA-44C (Audio Signal Generator) .....1.00\*  
 WO-33A (Super Portable Oscilloscope) .....1.00\*  
 WO-88A (5-in. Oscilloscope) ...0.75\*  
 WO-91A (5-in. Oscilloscope) ...1.00\*

WO-91B (5-in. Oscilloscope) ...1.00\*  
 WR-36A (Dot-Bar Generator) .0.50\*  
 WR-46A (Video Dot/Crosshatch Generator) .....1.00\*  
 WR-49A (RF Signal Generator) .....0.50\*  
 WR-49B (RF Signal Generator) .....1.00\*  
 WR-50A (RF Signal Generator) .....1.00\*  
 WR-51A (Stereo FM Signal Simulator) .....1.00\*  
 WR-52A (Stereo FM Signal Simulator) .....1.00\*  
 WR-61B (Color-Bar Generator) .....1.00\*  
 WR-64A (Color Bar/Dot/Crosshatch Generator) .....1.00\*  
 WR-64B (Color/Bar/Dot/Crosshatch Generator) .....1.00\*  
 WR-67A (Test-Oscillator) .....0.25\*  
 WR-69A (Television/FM Sweep Generator) .....1.00\*  
 WR-70A (RF-IF-VF Marker Adder) .....0.75\*  
 WR-86A (UHF Sweep Generator) .....0.50\*  
 WR-99A (Marker Calibrator) ..1.00\*  
 WT-100A (Electron-Tube Micro Mho Meter) .....1.75\*  
 WT-100A (Electron-Tube Micro Mho Meter, Ser. No. 1001 and over) .....2.00\*  
 WT-100A (Tube Chart 1CE-163) .....3.00\*  
 WT-110A (Automatic Electron-Tube Tester) .....0.75\*  
 WT-110A (1CE-174 Card Punch Data) .....0.25\*  
 WT-110A (1CE-234 Card Punch Data) .....1.00\*  
 WT-115A (Color Picture Tube Tester) .....0.50\*  
 WV-37A (Radio Battery Tester) .....0.25\*  
 WV-37B (Radio Battery Tester) .....0.25\*  
 WV-38A (Volt-Ohm-Milliammeter) .....0.50\*  
 WV-65A (VoltOhmyst†) .....0.25\*  
 WV-74A (High Sensitivity AC VTVM) .....0.75\*



WV-75A (VoltOhmyst†) .....	0.25*	WV-98A (Senior VoltOhmyst†) .....	1.00*
WV-76A (High Sensitivity AC VTVM) .....	0.75*	WV-98B (Senior VoltOhmyst†) .....	1.00*
WV-77A (VoltOhmyst†) .....	0.25*	WV-98C (Senior VoltOhmyst†) .....	0.50*
WV-77B (VoltOhmyst†) .....	0.25*	195-A (VoltOhmyst†) .....	0.25*
WV-77E (VoltOhmyst†) .....	1.00*		
WV-84C (Ultra-Sensitive DC Microammeter) .....	0.75*		
WV-95A (Master VoltOhmyst†) .....	0.25*		
WV-97A (Senior VoltOhmyst†) .....	0.75*		

\* Trade Mark Reg. U.S. Pat. Off.

\* Prices shown apply in U.S.A. and are subject to change without notice.

† Suggested price.

## Reading List

This list includes references of both elementary and advanced character. Obviously, the list is not inclusive, but it will guide the reader to other references.

- ALBERT, A. L. *Electrons and Electron Devices*. The Macmillan Co.
- BECK, A. H. W. *Thermionic Valves*. Cambridge University Press
- CHUTE, G. M. *Electronics in Industry*. McGraw-Hill Book Co., Inc.
- DOMER, R. B. *Television Principles*. McGraw-Hill Book Co., Inc.
- DOW, W. G. *Fundamentals of Engineering Electronics*. John Wiley and Sons, Inc.
- EASTMAN, A. V. *Fundamentals of Vacuum Tubes*. McGraw-Hill Book Co., Inc.
- EDSON, W. A. *Vacuum Tube Oscillators*. John Wiley and Sons, Inc.
- FINK, D. G. *Television Engineering*. McGraw-Hill Book Co., Inc.
- GHIRARDI, A. A. *Radio and Television Receiver Circuitry and Operation*. Rinehart and Co., Inc.
- GRAY, T. S. *Applied Electronics*. John Wiley and Sons, Inc.
- GROB, B. *Basic Television*. McGraw-Hill Book Co., Inc.
- HENNEY, KEITH. *Radio Engineering Handbook*. McGraw-Hill Book Co., Inc.
- HOAG, J. B. *Basic Radio*. D. Van Nostrand Co., Inc.
- KOLLER, L. R. *Physics of Electron Tubes*. McGraw-Hill Book Co., Inc.
- MAEDEL, G. F. *Basic Mathematics for Television and Radio*. Prentice-Hall, Inc.
- MARCUS, A. *Elements of Radio*. Prentice-Hall, Inc.
- MARKUS AND ZELUFF. *Handbook of Industrial Electronic Circuits*. McGraw-Hill Book Co., Inc.
- MILLMAN AND SEELY. *Electronics*. McGraw-Hill Book Co., Inc.
- MOYER AND WOSTREL. *Radio Receiving and Television Tubes*. McGraw-Hill Book Co., Inc.
- PENDER, DELMAR, AND MCILWAIN. *Handbook for Electrical Engineers—Communications and Electronics*. John Wiley and Sons, Inc.
- PREISMAN, A. *Graphical Constructions for Vacuum Tube Circuits*. McGraw-Hill Book Co., Inc.
- HICKEY, H. V., and VILLINES, JR., W. M. *Elements of Electronics*. McGraw-Hill Book Co., Inc.
- RCA TECHNICAL BOOK SERIES. *Electron Tubes, Vol. I and Vol. II*. RCA Review.
- REICH, H. J. *Theory and Applications of Electron Tubes*. McGraw-Hill Book Co., Inc.
- LICHTER, WALTHER. *Fundamentals of Industrial Electronic Circuits*. McGraw-Hill Book Co., Inc.
- SEELY, S. *Electron Tube Circuits*. McGraw-Hill Book Co., Inc.
- LANGENBERG, K. R. *Vacuum Tubes*. McGraw-Hill Book Co., Inc.
- ORLEY, K. R. *Radio Receiver Design*. Chapman and Hall, Ltd.
- MAN, F. E. *Fundamentals of Radio*. McGraw-Hill Book Co., Inc.
- MAN, F. E. *Radio Engineers Handbook*. McGraw-Hill Book Co., Inc.
- Radio Amateurs Handbook*. American Radio Relay League.
- VKIN AND MORTON. *Television: The Electronics of Image Transmission*. John Wiley and Sons, Inc.

## KEY: BASING DIAGRAMS (Bottom Views)

Gas-Type Tube	F-	Filament (negative only)	LC	Do Not Use, Except As Specified in Data
Base Sleeve				
Base Shell	F <sub>M</sub>	Filament Tap	NC	No Internal Connection— May Be Used As Tie Point
External Con- ductive Coating	G	Grid		
Collector	H	Heater		
Deflecting Elec- trode	H <sub>L</sub>	Heater Tap for Panel Lamp	P	Plate (Anode)
External Shield	H <sub>M</sub>	Heater Tap	RCJ	Ray-Control Electrode
Filament	IC	Do Not Use	S	Shell
Filament (positive only)	IS	Internal Shield	TA	Fluorescent Target
	K	Cathode		

Scripts for multi-unit types: B, beam power unit; D, diode unit; HP, heptode unit; HX, X-ray tube unit; P, pentode unit; T, triode unit; TR, tetrode unit.

Many tube types are available in addition to the home-entertainment types described in this manual. For industrial and specialized applications, other small receiving-type tubes are available, such as nuvistor tubes, "premium" tubes, thyratrons, cold-cathode (glow-discharge) tubes, computer tubes, tubes for mobile communications application, and Special Red tubes. Other lines of RCA electron devices include:

### POWER TUBES

*Transmitting and  
Industrial Types*

### TELEVISION CAMERA TUBES

*Image Orthicons,  
Vidicons, and  
Monoscopes*

### PHOTOTUBES

*Single-Unit, Twin-Unit,  
and Multiplier Types*

### PHOTOCELLS

*Photoconductive and  
Photojunction Types*

### INTEGRATED CIRCUITS

*Digital and Linear Types*

### MICROWAVE TUBES

*Magnetrons, Traveling-Wave  
Tubes, Pencil Tubes*

### CATHODE-RAY TUBES

*Special-Purpose Kinescopes,  
Storage Tubes, and  
Oscillograph Types*

### SPECIAL TYPES

*Vacuum Gauge Tubes,  
Image Converters*

### SEMICONDUCTOR DEVICES

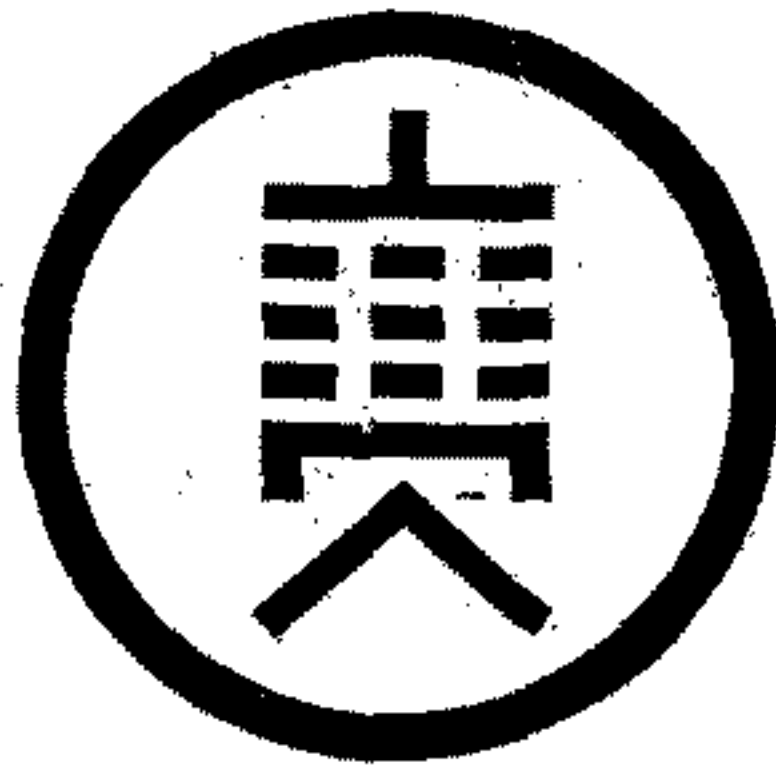
*Germanium and Silicon  
Transistors, Silicon Rectifiers,  
Tunnel Diodes,  
Silicon Controlled Rectifiers,  
Memory Devices*

### THYRATRONS and IGNITRONS

# RADIO CORPORATION OF AMERICA

ELECTRONIC COMPONENTS AND DEVICES

HARRISON, N. J.



**RCA RECEIVING TUBE MANUAL**